

# S8 Escape™ System

---

USER'S MANUAL

English

338215-Eng/3 05 08

## S8 Escape™

Component of 338215/3  
 Composant du 338215/3  
 Componente de 338215/3  
 Componente de 338215/3

ILLUSTRATIONS  
 ILLUSTRATIONS  
 FIGURAS  
 ILUSTRAÇÕES

### A SYSTEM COMPONENTS / COMPOSANTS DU SYSTÈME / COMPONENTES DEL SISTEMA / COMPONENTES DO SISTEMA

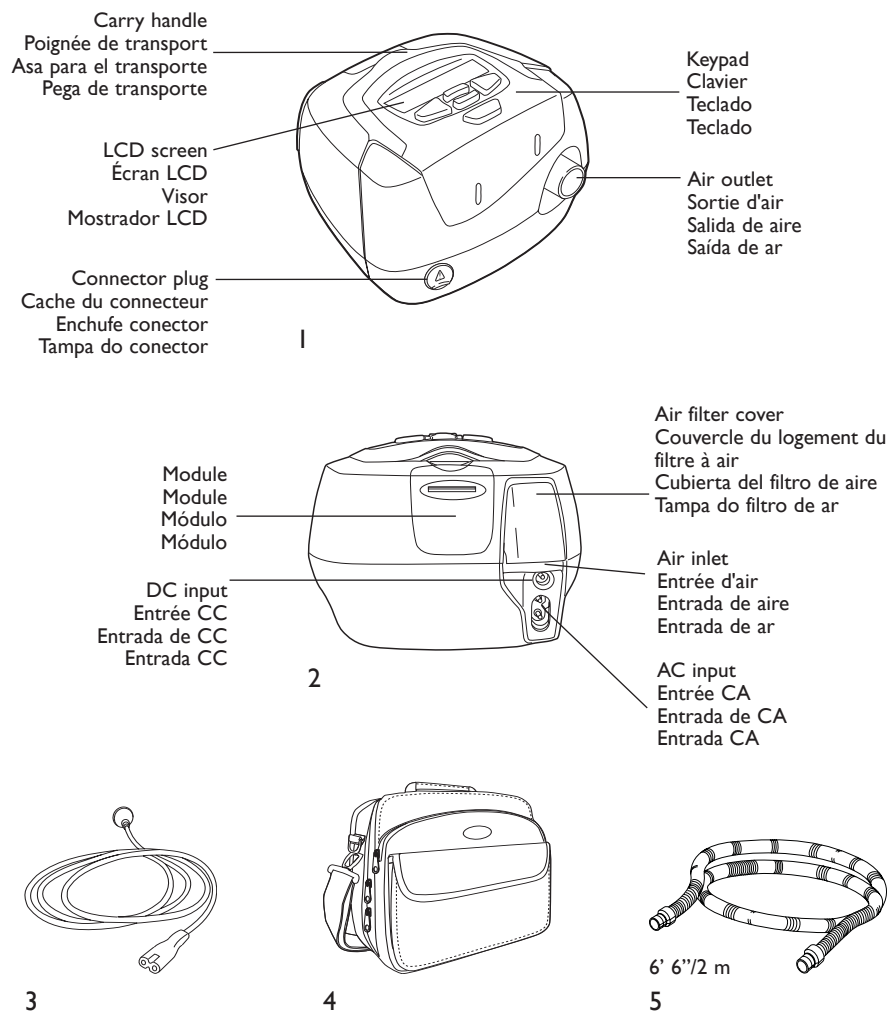

© 2005 ResMed Ltd.

### B INTEGRATED HUMIDIFIER / HUMIDIFICATEUR INTÉGRÉ/ HUMIDIFICADOR INTEGRADO / HUMIDIFICADOR INTEGRADO

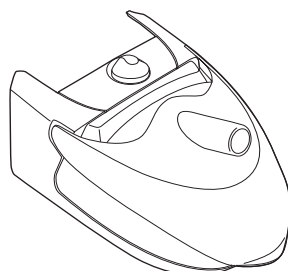

HumidAire 3i™

© 2005 ResMed Ltd.

### C OTHER ACCESSORIES / AUTRES ACCESSOIRES / OTROS ACCESORIOS / OUTROS ACESSÓRIOS

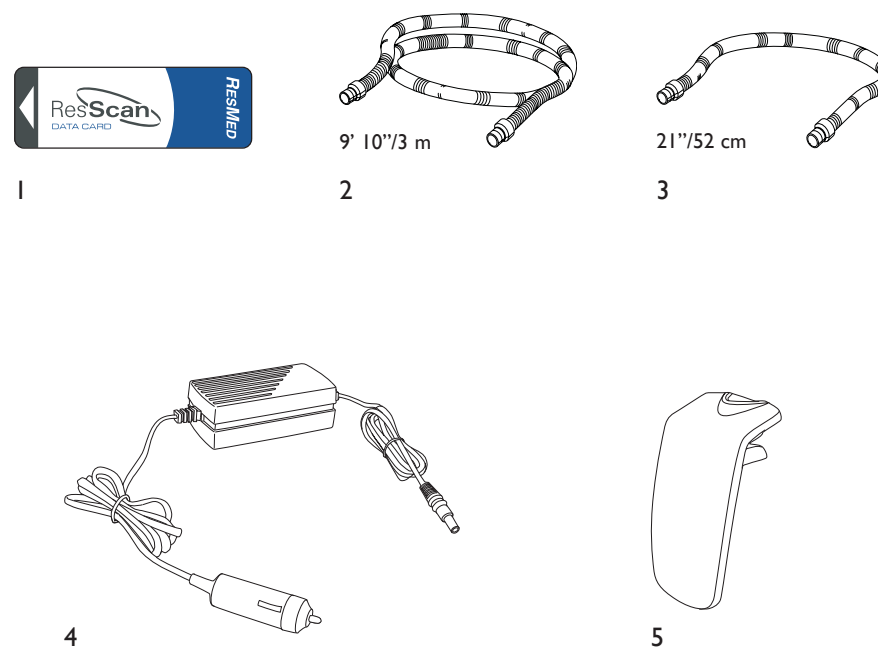

© 2005 ResMed Ltd.

### D SETTING UP THE S8™ / INSTALLATION DE LA S8 / INSTALACIÓN DEL S8 / MONTAGEM DO S8

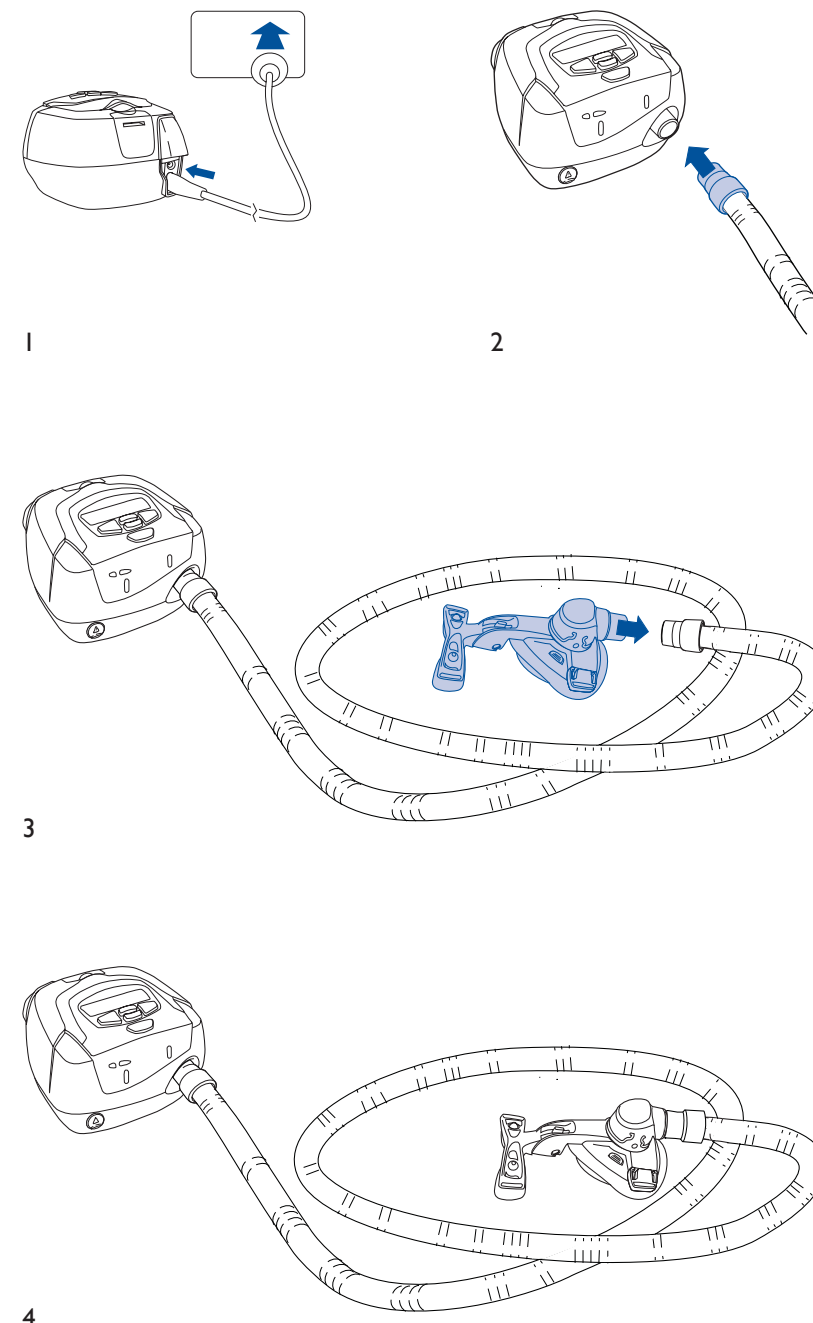

© 2005 ResMed Ltd.

**E**

HUMIDAIRE 3i and S8 ESCAPE / HUMIDAIRE 3i et S8 ESCAPE /  
 HUMIDAIRE 3i y S8 ESCAPE / HUMIDAIRE 3i e S8 ESCAPE

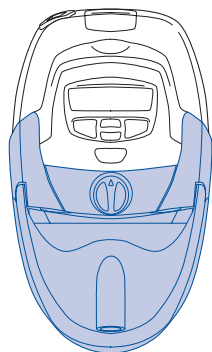

© 2005 ResMed Ltd.

**H**

USING THE DATA CARD / UTILISATION DE LA CARTE DE DONNÉES / USO DE LA TARJETA DE DATOS /  
 COMO USAR O CARTÃO DE DADOS

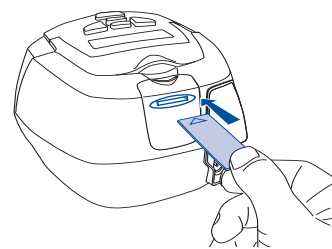

1

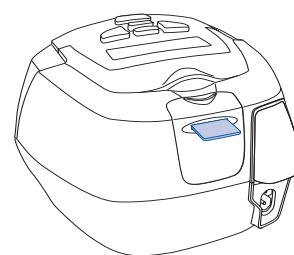

2

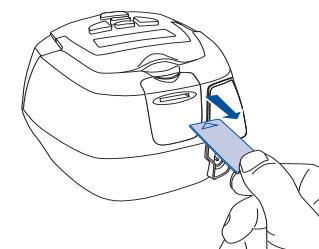

3

© 2005 ResMed Ltd.

**F**

BLANK MODULE / MODULE VIERGE / MÓDULO EN BLANCO /  
 MÓDULO EM BRANCO

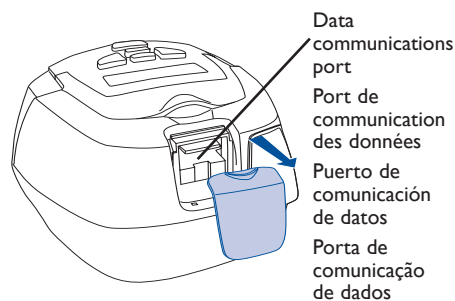

1

Data communications port  
 Port de communication des données  
 Puerto de comunicación de datos  
 Porta de comunicação de dados

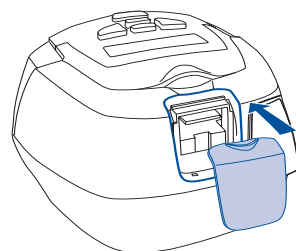

2

© 2005 ResMed Ltd.

**I**

USING A HUMIDAIRE™ / UTILISATION D'UN HUMIDAIRE / USO DE UN HUMIDAIRE / UTILIZAÇÃO DE UM HUMIDAIRE

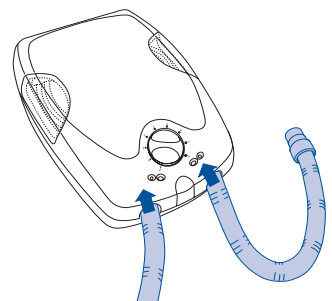

1

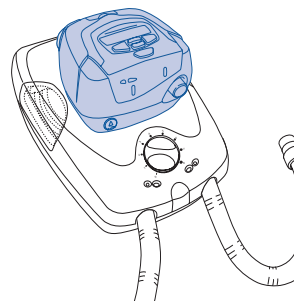

2

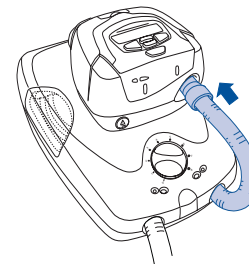

3

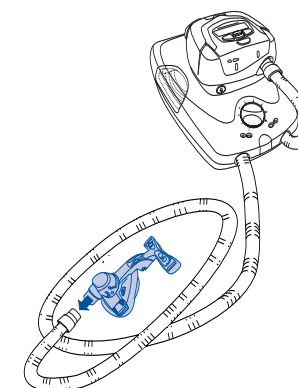

4

© 2005 ResMed Ltd.

**G**

DATA CARD MODULE / MODULE DE CARTE DE DONNÉES /  
 MÓDULO TARJETA DE DATOS / COMO USAR O CARTÃO DE DADOS

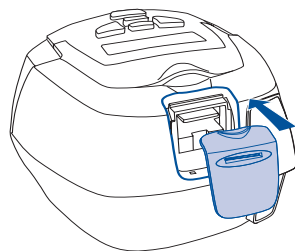

1

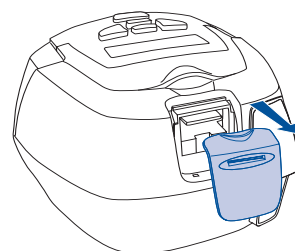

2

© 2005 ResMed Ltd.

**J**

USING A RESMED PASSEOVER / UTILISATION D'UN PASSEOVER RESMED / USO DE UN PASSEOVER DE RESMED / UTILIZAÇÃO DE UM RESMED PASSEOVER

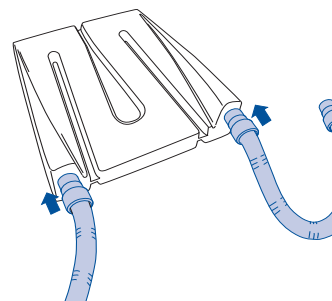

1

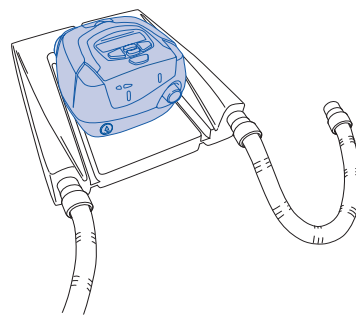

2

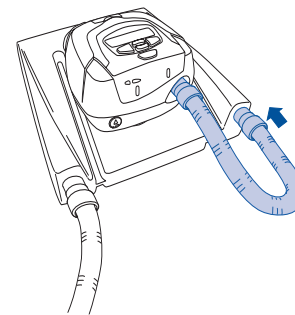

3

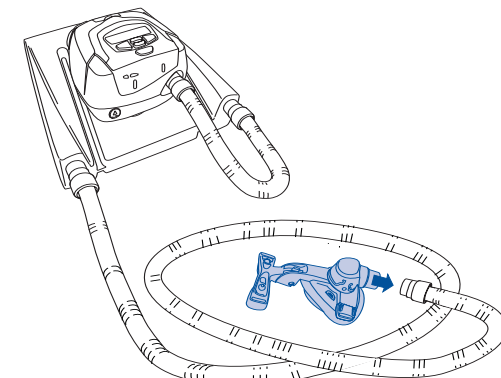

4

© 2005 ResMed Ltd.

**Note: Some products not available in all regions.** / Remarque : certains produits ne sont pas disponibles dans tous les pays. / Nota: algunos productos no están disponibles en todas las regiones. / Nota: Alguns produtos não se encontram disponíveis em todas as regiões.

# CONTENTS

INTRODUCTION .....	5
YOUR RESPONSIBILITY .....	5
MEDICAL INFORMATION .....	5
ABOUT THE S8 ESCAPE™ .....	5
CONTRAINDICATIONS .....	6
WARNINGS .....	6
CAUTIONS .....	7
ADVERSE EFFECTS .....	8
THE S8 ESCAPE SYSTEM .....	9
S8 ESCAPE .....	9
MASKS .....	9
HUMIDIFIERS .....	10
RES SCAN DATA CARD MODULE .....	10
ACCESSORIES .....	10
HOW TO USE THE S8 ESCAPE .....	11
SET UP THE S8 ESCAPE .....	11
ASSEMBLE THE MASK .....	11
START TREATMENT .....	11
STOP TREATMENT .....	12
HOW TO ATTACH A HUMIDIFIER .....	13
ATTACH A HUMIDAIRE 3i HUMIDIFIER .....	13
ATTACH A HUMIDAIRE HUMIDIFIER .....	13
ATTACH A RESMED PASSOVER HUMIDIFIER .....	14
HOW TO USE THE KEYPAD .....	15
HOW TO CHANGE THE SETTINGS ON YOUR S8 ESCAPE .....	16
S8 MODULES .....	19
USING A BLANK MODULE .....	19
USING A RES SCAN DATA CARD MODULE .....	19
CLEANING AND MAINTENANCE .....	22
DAILY CLEANING .....	22
WEEKLY CLEANING .....	22
PERIODIC CLEANING .....	22
REPLACING THE AIR FILTER .....	23
SERVICING .....	23
FREQUENTLY ASKED QUESTIONS .....	24
TROUBLESHOOTING .....	26

SYSTEM SPECIFICATIONS ..... 29  
    S8 ESCAPE ..... 29  
    ACCESSORIES ..... 29  
LIMITED WARRANTY ..... 35  
INDEX ..... 37

# INTRODUCTION

Thank you for choosing the **S8 ESCAPE™** flow generator. The **S8 ESCAPE** is a compact, all-in-one package with an inbuilt power supply and the option of integrated data management and humidification.

This user manual contains the information you need for the correct use of your **S8 ESCAPE**.

## YOUR RESPONSIBILITY

The owner or user of this system shall have sole responsibility and liability for any injury to persons or damage to property resulting from:

- operation which is not in accordance with the operating instructions supplied
- maintenance or modifications carried out unless in accordance with authorized instructions and by authorized persons.

### **Please read this manual carefully before use.**

This manual contains special terms and icons that appear in the margins to draw your attention to specific and important information.

- Warning alerts you to possible injury.
- Caution explains special measures for the safe and effective use of the device.
- Note is an informative or helpful note.

# MEDICAL INFORMATION

## ABOUT THE **S8 ESCAPE™**

The **S8 ESCAPE** continuous positive airway pressure (CPAP) system is indicated for the treatment of obstructive sleep apnea (OSA) in adult patients.

The **S8 ESCAPE** CPAP system is intended for home and hospital use.



### **CAUTION**

In the US, Federal law restricts this device to sale by or on the order of a physician.

## CONTRAINDICATIONS

The S8 ESCAPE is not a life support device and may stop operating during power failure or certain fault conditions. It should not be used by patients who are dependent on continuous therapy.

Positive airway pressure therapy may be contraindicated in some patients with the following pre-existing conditions:

- severe bullous lung disease
- pneumothorax
- pathologically low blood pressure
- dehydration
- cerebrospinal fluid leak, recent cranial surgery, or trauma.

## WARNINGS

- Read the entire manual before using the S8 ESCAPE.
- Advice contained in this manual should not supersede instructions given by the prescribing physician.
- A patient should not connect a device to the data communication port unless instructed to do so by their health care provider or physician. Only ResMed products are designed to be connected to the data communication port. Connecting other devices could result in injury, or damage to the S8 ESCAPE device.
- The S8 ESCAPE should only be used with masks (and connectors)\* recommended by ResMed, or by a physician or respiratory therapist. A mask should not be used unless the S8 ESCAPE device is turned on and operating properly. The vent hole or holes associated with the mask should never be blocked.

**Explanation:** The S8 ESCAPE is intended to be used with special masks (or connectors)\* which have vent holes to allow continuous flow of air out of the mask. When the device is turned on and functioning properly, new air from the device flushes the exhaled air out through the mask vent holes. However, when the device is not operating, insufficient fresh air will be provided through the mask, and the exhaled air may be rebreathed. Rebreathing of exhaled air for longer than several minutes can, in some circumstances, lead to suffocation. This applies to most models of CPAP devices.

- In the event of power failure or machine malfunction, remove the mask.
- The S8 ESCAPE can be set to deliver pressures up to 20 cm H<sub>2</sub>O. In the unlikely event of certain fault conditions, pressures up to 30 cm H<sub>2</sub>O are possible.

---

\* Ports may be incorporated into the mask or in connectors that are near the mask.

- If oxygen is used with this device, the oxygen flow must be turned off when the device is not operating.  
If oxygen has been left on, turn off the flow generator, then wait 30 minutes before turning on the flow generator again.

**Explanation:** When the CPAP device is not in operation and the oxygen flow is left on, oxygen delivered into the air delivery tubing may accumulate within the CPAP machine enclosure and create a risk of fire. This applies to most types of CPAP machines.

- Oxygen supports combustion. Oxygen should not be used while you are smoking or in the presence of an open flame.
- Always ensure airflow is being generated by the device before the oxygen supply is turned on.
- Always turn the oxygen supply off before stopping the airflow from the device.

**Note:** *At a fixed rate of supplemental oxygen flow, the inhaled oxygen concentration will vary, depending on where the oxygen is introduced, the pressure settings, patient breathing pattern, mask selection, and leak rate.*

- Do not use the **S8 ESCAPE** if there are obvious external defects or unexplained changes in performance.
- Do not open the **S8 ESCAPE** case. There are no user serviceable parts inside. Repairs and internal servicing should only be performed by an authorized service agent.
- Explosion hazard—do not use in the vicinity of flammable anesthetics.

## CAUTIONS

- At low pressures, the flow through the exhalation ports of your mask may not clear all exhaled gas from the tubing. Some rebreathing may occur.
- The airflow for breathing produced by this device can be as much as 11°F (6°C) higher than the temperature of the room. Caution should be exercised if the room temperature is warmer than 90°F (32°C).
- When AC mains power (100–240V AC) is not available, always use a ResMed DC-12 converter. (The DC-12 converter is available as an optional accessory. It is not supplied with all models.)
- If supplied, the Data Card module is designed for use with specific ResMed devices.
- Only use the Data Card module (if supplied) as specified in this manual.

**Note:** *The above are general warnings and cautions. Specific warnings, cautions, and notes appear with the relevant instructions in the manual.*



## ADVERSE EFFECTS

Patients should report unusual chest pain, severe headache, or increased breathlessness to their prescribing physician. An acute upper respiratory tract infection may require temporary discontinuation of treatment.

The following side effects may arise during the course of therapy with the CPAP device:

- drying of the nose, mouth, or throat
- nosebleed
- bloating
- ear or sinus discomfort
- eye irritation
- skin rashes
- chest discomfort.

# THE S8 ESCAPE SYSTEM

The S8 ESCAPE device is part of a system that consists of five elements:

- S8 ESCAPE flow generator
- Mask
- Humidifier
- Data management products
- Accessories.

## S8 ESCAPE

Please refer to the illustrations in section **A** of the illustration sheet.

### FRONT VIEW (A-1)

Shows the keypad and LCD screen, and the air outlet.

### REAR VIEW (A-2)

Shows where the module attaches, and the location of the air filter and power sockets.

### POWER CORD (A-3)

Power cord to attach the S8 ESCAPE to the AC (mains) power.

### CARRY BAG (A-4)

The S8 ESCAPE carry bag contains two pouches: one for storing the S8 device, the other for storing the HUMIDAIRE 3i™. When storing the HUMIDAIRE 3i, always put it in the larger, mesh pouch.

### AIR TUBING

The 6'6" (2 m) air tubing (**A-5**) connects the S8 ESCAPE to your mask. You will need medium 21" (52 cm) air tubing (see **C-3**) to connect the S8 ESCAPE to the HUMIDAIRE™ and ResMed PASSOVER humidifiers.

## MASKS

You will also need a **ResMed mask system** (supplied separately).

The ResMed mask systems that are recommended for use with the S8 ESCAPE are:

### NASAL MASKS

- MODULAR NASAL MASK
- MIRAGE VISTA™ NASAL MASK
- ULTRA MIRAGE™ NASAL MASK
- MIRAGE™ NASAL MASK
- PROTEGE™ NASAL MASK
- MIRAGE ACTIVA™ NASAL MASK
- PAPILLON™.

### NASAL PILLOWS SYSTEMS

- MIRAGE SWIFT™ NASAL PILLOWS SYSTEM.

## FULL FACE MASKS

- MIRAGE™ FULL FACE MASK
- MIRAGE™ FULL FACE MASK SERIES 2
- ULTRA MIRAGE™ FULL FACE MASK.



## WARNING

Only ResMed mask systems are compatible for use with the S8 Escape. Please refer to “Warnings” on page 6.

## HUMIDIFIERS

A humidifier may be required if you are experiencing dryness of the nose, throat, or mouth. The S8 ESCAPE is compatible for use with:

- HUMIDAIRE 3i integrated heated humidifier (**Figure B** on the illustrations sheet)
- HUMIDAIRE heated humidifier (**Figure I** on the illustrations sheet)
- ResMed PASSOVER humidifier (**Figure J** on the illustrations sheet).

## RESCAN DATA CARD MODULE

The RESCAN™ Data Card module and RESCAN Data Card (**C-1**) may be used with the S8 ESCAPE either to help your clinician to monitor your treatment or to provide you with updates to your device settings. See “Using a ResScan Data Card Module” on page 19 for information about how to use the Data Card module and Data Card.

## ACCESSORIES

*Please refer to the illustrations in section C of the illustration sheet.*

Other accessories for use with the S8 ESCAPE:

- Air tubing 9'10" (3 m) (**C-2**)
- Medium air tubing 21" (52 cm) for HUMIDAIRE and ResMed PASSOVER connection (**C-3**)
- DC-12 converter (**C-4**)
- Blank module (**C-5**).

**Note:** ResMed regularly releases new products. Please check our website at <[www.myresmed.com](http://www.myresmed.com)>.

# HOW TO USE THE S8 ESCAPE

Please refer to the illustrations in section **D** of the illustration sheet.

## SET UP THE S8 ESCAPE

- 1 Place the S8 ESCAPE on a table near the head of your bed.



### CAUTION

Be careful not to place the device where it can be bumped or where someone is likely to trip over the power cord.

**Note:** You can also place your S8 Escape on the floor beside or underneath your bed. Ensure that the area is free from dust and clear of bedding, clothes, or any other objects that could block the air inlet.

- 2 Connect the power cord to the socket at the rear of the flow generator (**D-1**). Plug the other end of the power cord into the power outlet.



### WARNING

Make sure the power cord and plug are in good condition and the equipment is not damaged.

- 3 Connect one end of the air tubing firmly onto the air outlet (**D-2**).



### WARNING

- Only ResMed air tubing should be used with your flow generator. A different type of air tubing may alter the pressure you actually receive, reducing the effectiveness of your treatment.
- Blocking the hose while in operation could lead to overheating of the device.
- In the clinical environment any personal computer that is used with your CPAP system must be at least 5' (1.5 m) away from, or at least 8' (2.5 m) above, the patient. It must also comply with the relevant test standard. For personal computers the international standard is IEC 60950 or equivalent.

## ASSEMBLE THE MASK

- 1 Assemble your mask system according to the mask user instructions.
- 2 Connect your mask system to the free end of the air tubing (**D-3**).  
The S8 ESCAPE is now ready for use (**D-4**).

## START TREATMENT

- 1 Make sure the power is on.  
The product name is displayed briefly on the LCD screen, then the standby (Ramp) screen appears. The key and LCD backlights also turn on.

- Lie down and arrange the air tubing so that it is free to move if you turn in your sleep.



### **CAUTION**

- Do not leave long lengths of air tubing around the top of your bed. They could twist around your head or neck while you are sleeping.
- Make sure the area around the flow generator is dry and clean. It should also be clear of bedding, clothes, and other potential blockages.

- Alter the ramp time if required (see "How to Change the Ramp Time" on page 17).

- To start treatment, press the **Start/Stop** key.

- Fit your mask as described in the mask user instructions.



### **WARNING**

A mask should not be used unless the S8 Escape device is turned on and operating properly.

- When ramping begins the LCD will display the word "RAMPING", with the current pressure indicated as dashes. Each dash is approximately equivalent to 2 cm H<sub>2</sub>O. For example, 6 dashes represents approximately 12 cm H<sub>2</sub>O pressure.

### **STOP TREATMENT**

To stop treatment at any time, remove your mask and press the **Start/Stop** key.

# HOW TO ATTACH A HUMIDIFIER

## ATTACH A HUMIDAIRE 3i HUMIDIFIER

Please refer to the illustration in section **E** of the illustration sheet, and your HumidAire 3i manual.

The HUMIDAIRE 3i attaches to the front of the S8 ESCAPE to provide heated humidification. No other accessories are required for its use.

### Notes:

- Make sure the water chamber of the HumidAire 3i is empty before you attach or detach the humidifier.
- Remove the connector plug on the S8 Escape (see section **A** of the illustration sheet) before you attach the HumidAire 3i. Reattach the connector plug firmly after you detach the HumidAire 3i.

### STORING THE HUMIDAIRE 3i

Store the HUMIDAIRE 3i in the larger, mesh-top pouch of the S8 ESCAPE carry bag when not in use.

## ATTACH A HUMIDAIRE HUMIDIFIER

Please refer to the illustrations in section **I** of the illustration sheet.

To connect your S8 ESCAPE to a HUMIDAIRE humidifier you need medium sized 21" (52 cm) air tubing.

- Fill the HUMIDAIRE water chamber and place inside the HUMIDAIRE. Connect the medium 21" (52 cm) and long 6'6" (2 m) air tubing (**I-1**), and close the humidifier lid.
- Place the S8 ESCAPE on top of the HUMIDAIRE (**I-2**) and connect the free end of the medium air tubing to the air outlet (**I-3**).

**Note:** To avoid water spilling into the S8 ESCAPE, do not put it underneath the humidifier.

- Assemble your mask system and connect it to the free end of the long air tubing (**I-4**).
- Plug the HUMIDAIRE power cord into a power outlet. Connect the S8 ESCAPE power cord to the socket at the rear of the S8 ESCAPE and plug the other end into a power outlet.

Please refer to the *HumidAire User's Manual* for further details.



### WARNING

Make sure that the power cord and plug are in good condition and the equipment is not damaged.

The S8 ESCAPE is now ready for use with the HUMIDAIRE.

## ATTACH A RESMED PASSOVER HUMIDIFIER

Please refer to the illustrations in section **J** of the illustration sheet.

To connect your **S8 ESCAPE** to a ResMed **PASSOVER** humidifier you need medium sized 21" (52 cm) air tubing.

- 1** Fill the **PASSOVER** with water and connect the medium 21" (52 cm) and long 6'6" (2 m) air tubing (**J-1**).
- 2** Place the **S8 ESCAPE** on top of the **PASSOVER** (**J-2**) and connect the free end of the medium air tubing to the air outlet (**J-3**).  
**Note:** To avoid water spilling into the **S8 ESCAPE**, do not place it underneath the humidifier.
- 3** Assemble your mask system and connect it to the free end of the long air tubing (**J-4**).
- 4** Connect the power cord to the socket at the rear of the **S8 ESCAPE** and plug the other end into a power outlet.  
Please refer to the *ResMed Passover User's Manual* for further details.



### **WARNING**

**Make sure that the power cord and plug are in good condition and the equipment is not damaged.**

The **S8 ESCAPE** is now ready for use with the **PASSOVER**.

# HOW TO USE THE KEYPAD

The control panel of the S8 ESCAPE includes an LCD screen and keypad for navigating through the menus and delivering treatment.

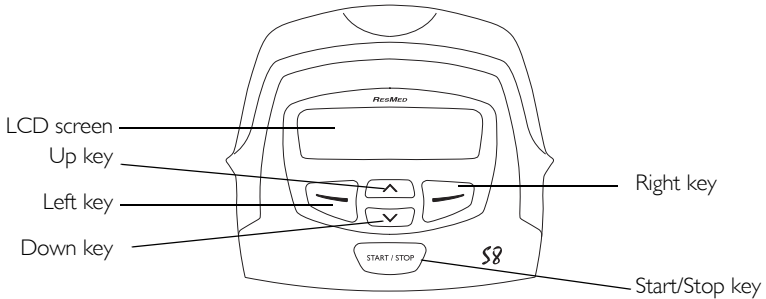





## LCD SCREEN

The LCD screen displays the menus and treatment screens.



## KEYPAD KEYS

The S8 ESCAPE keypad has the following keys:

Key	Function
<b>Start/Stop</b> 	<ul style="list-style-type: none"> <li>Starts or stops treatment.</li> </ul>
<b>Up</b> 	<ul style="list-style-type: none"> <li>Allows you to increase settings options and scroll through the S8 ESCAPE menu.</li> </ul>
<b>Down</b> 	<ul style="list-style-type: none"> <li>Allows you to decrease settings options and scroll through the S8 ESCAPE menu.</li> </ul>
<b>Left</b> 	<ul style="list-style-type: none"> <li>Performs the function indicated by the guiding text displayed above it on the LCD screen. Guiding text includes <b>menu</b>, <b>change</b>, and <b>apply</b>.</li> </ul>
<b>Right</b> 	<ul style="list-style-type: none"> <li>Performs the function indicated by the guiding text displayed above it on the LCD screen. Guiding text includes <b>exit</b> and <b>cancel</b>.</li> </ul>

## BACKLIGHTS

The keypad and LCD are equipped with backlights that come on when the device is powered. The LCD backlight turns off after two minutes of inactivity, and comes back



on when you press a key. Once the **Start/Stop** key has been pressed to start treatment, the LCD backlight stays on for two minutes. The keypad backlight is always on while the **S8 ESCAPE** is on.

## HOW TO CHANGE THE SETTINGS ON YOUR S8 ESCAPE

You can change settings (such as Ramp Time, Altitude) on the **S8 ESCAPE** by using the keypad and LCD. When the **S8 ESCAPE** is in standby mode you can display a series of screens (a menu) on the LCD screen in order to view and change the settings for a particular function.

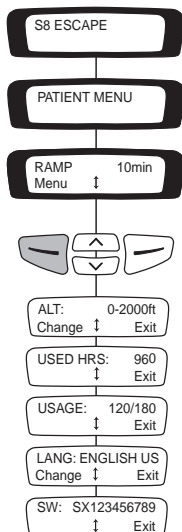

Use the menu screens to change the ramp time, altitude compensation, and language. You can also view details about the usage and software version of your **S8 ESCAPE**.

### HOW TO ENTER THE MENU SCREENS

When the **S8 ESCAPE** standby screen is displayed you will see the word 'Menu' in the left-hand corner. To select the **S8 ESCAPE** menu, press the **Left** key.

### HOW TO SCROLL THROUGH THE MENU

When you are in the menu, scroll through items by pressing the **Up** or **Down** keys.

### HOW TO CHANGE A SETTING OPTION

When you have scrolled to the item you require:

1. Press the **Left** key (Change).
2. Press the **Up** or **Down** keys until you see the setting option that you require.
3. Press the **Left** key (Apply) to select the setting option.

If you wish to exit without changing the option, press the **Right** key (Cancel).

### HOW TO EXIT OUT OF A MENU

Press the **Right** key (Exit). This will take you back to the Patient Menu screen.

### HOW TO EXIT OUT OF AN ITEM WITHIN THE MENU

Press the **Right** key (Exit).

### HOW TO CHANGE THE RAMP TIME

During ramp time, the pressure increases from a low pressure to the prescribed treatment pressure. You can set the ramp time in 5-minute intervals, from 0 minutes (OFF) up to a maximum ramp time set by your clinician.

The standby screen displays the current ramp time in the right-hand corner. To change the ramp time, press the **Up** or **Down** key until the desired ramp time appears.

Once a ramp time is selected, begin therapy by pressing the **Start/Stop** key.

When ramping begins the LCD will display the word "RAMPING", with the current pressure indicated as dashes. Each dash is approximately equivalent to 2 cm H<sub>2</sub>O. For example, six dashes represents approximately 12 cm H<sub>2</sub>O pressure.

### HOW TO CHANGE THE ALTITUDE SETTING

If you move or travel with your **S8 ESCAPE** to areas of different altitude, you will need to adjust the altitude compensation setting. Changes in altitude will affect the pressure delivered by the **S8 ESCAPE**.

You can use the Altitude setting (ALT) to specify the altitude range at which you are using your **S8 ESCAPE**. Select the **S8 ESCAPE** menu by pressing the **Left** key in the standby (RAMP) screen. Scroll to ALT and select Change (**Left** key). Press the **Up** or **Down** keys until you see the setting option that you require.

There are four altitude settings to choose from:

- 0–2000ft (0–609 m)
- 2001–4000ft (610–1219 m)
- 4001–6000ft (1220–1828 m)
- 6001–8500ft (1829–2591 m).

For example, if you are at an altitude of 3107' (947 m), your altitude compensation setting would be 2001–4000ft (610–1219 m), as 3107' (947 m) falls within that range.

Press the **Left** key (Apply) to select the correct setting.

### HOW TO CHANGE THE LANGUAGE SETTING

To display menus and messages in a different language, select the **S8 ESCAPE** menu by pressing the **Left** key in the standby (Ramp) screen. Scroll to LANG and select Change (**Left** key). Press the **Up** or **Down** keys until you see the language that you require.

### OTHER VIEWABLE INFORMATION

You can also view the total number of hours of treatment (USED HRS); the number of sessions that the **S8 ESCAPE** was used in a usage period (USAGE); and the current software version installed on your unit (SW). Access to all of these screens is provided via the menu. See "How to enter the menu screens" on page 16.

## MESSAGES ON THE S8 ESCAPE LCD

Your clinician may have set your **S8 ESCAPE** to remind you about important events, such as when to replace your mask, when to insert your Data Card (if your device is Data Card enabled) and so on.

The reminder message is displayed on the LCD and is visible if the device is not delivering therapy. The backlight on the LCD flashes when a message is displayed.

Your clinician can set any of the following reminders on your LCD:

Message	Description	Action
INSERT CARD	May appear if your device is Data Card enabled.	Insert your Data Card and follow any instructions that your clinician has given you. When you have done this, the message will disappear from the LCD. Pressing the <b>Left</b> (Ok) key will also remove the message.
REPLACE MASK	May appear when your mask is due for replacement.	Press the <b>Left</b> (Ok) key to remove the message from your LCD, and replace your mask with a new one.
CALL PROVIDER	May appear as a reminder to contact your clinician; for example to discuss how your therapy is going.	Press the <b>Left</b> (Ok) key to remove the message from your LCD, and contact your clinician.
REPLACE FILTER	May appear as a reminder to replace the air filter on your device.	Press the <b>Left</b> (Ok) key to remove the message from your LCD, and replace the air filter.
SERVICE DUE	May appear as a reminder to return your device for service.	Press the <b>Left</b> (Ok) key to remove the message from your LCD, and contact your clinician.

# S8 MODULES

**Note:** Do not remove modules while power is connected to the S8 Escape.

Your S8 ESCAPE will have one of two modules fitted to the back: a blank module or a RESSCAN™ Data Card module.

## USING A BLANK MODULE

Please refer to the illustrations in section **F** of the illustration sheet.

The blank module is a protective cover on the S8 ESCAPE. At times, you may wish to remove or attach this module, for example to use the serial adapter.

To remove the blank module, pull it off the back of the S8 ESCAPE to show the data communications port (**F-1**).

To attach the blank module, push the blank module onto the data communications port, until the module clicks into place (**F-2**).

**Note:** To protect the data communications port, always ensure there is a module attached to the device.

## USING A RESSCAN DATA CARD MODULE

Please refer to the illustrations in section **G** of the illustration sheet.

The RESSCAN Data Card module is an accessory to the S8 ESCAPE. Use a RESSCAN Data Card with the Data Card module to collect data and update settings in the S8 ESCAPE. The module and card give your clinician convenient access to data about your treatment, and can provide you with new device settings from your clinician without you having to leave home.

### ATTACHING THE MODULE

To attach the Data Card module, push it onto the data communications port at the back of your S8 ESCAPE until it clicks into place (**G-1**).

### REMOVING THE MODULE

To remove the Data Card module, pull it off the back of the S8 ESCAPE (**G-2**).

**Note:** To protect the data communications port, always ensure there is a module attached to the device.

### USING THE DATA CARD TO COLLECT DATA

Please refer to the illustrations in section **H** of the illustration sheet.

If your clinician needs to review your treatment, they will ask you to use the Data Card to copy data from your S8 ESCAPE, and to return the card to them. The Data Card will be provided in a convenient mailback envelope.

Data that is copied to a Data Card is still stored and available on the S8 ESCAPE.

It takes approximately five seconds to copy data onto the Data Card.

## 1 INSERT THE DATA CARD

- Switch on the **S8 ESCAPE** and wait until you see the standby (Ramp) screen.
- Hold the Data Card with the arrow facing up and insert it into the slot in the Data Card module (**H-1**).
- Push the card in smoothly until it stops moving (**H-2**) and messages start appearing on the LCD.

## 2 COPY DATA ONTO THE DATA CARD

- Data copying starts automatically when the Data Card is inserted into the Data Card module.
- The “Card Inserted Please Wait” message is displayed on the **S8 ESCAPE** LCD while data is being copied. Copying takes approximately five seconds.
- The “Copy Complete Remove Card” message is displayed on the LCD when copying has finished.
- Remove the Data Card from the Data Card module.

## 3 REMOVE THE DATA CARD

Grip the end of the Data Card and pull it out of the Data Card module (**H-3**).

## 4 STORE THE DATA CARD

Your Data Card should be stored in its mailback envelope when not in use.

## 5 MAIL THE DATA CARD TO YOUR CLINICIAN

A bubble mailer envelope is provided to ensure safe transportation of the Data Card. When mailing the Data Card to your clinician:

1. Insert the Data Card into the pocket provided on the mailback envelope. Fold up the mailback envelope.
2. Place the mailback envelope containing the Data Card in the bubble mailer envelope and seal it.
3. Make sure that your clinician’s name and address details are on the bubble mailer envelope, and mail it back immediately.

## USING THE DATA CARD TO UPDATE SETTINGS

If your clinician has provided a Data Card with new device settings:

- With the device in standby (Ramp) mode, insert the Data Card into the slot on the Data Card module. Updating will start automatically.
- The “Card Inserted Please Wait” message is displayed on the LCD while updating is in progress. Updating takes approximately five seconds.
- The “Settings Success Remove Card” message is displayed on the LCD if the settings were updated successfully.

**Note:** *This message only appears once. If you re-insert the Data Card after you have updated your settings, this message is not displayed.*

- Remove the Data Card from the Data Card module.
- Store the Data Card in its mailback envelope when not in use.

**WARNING**

If your clinician has told you to use this Data Card to update the settings on your device and the “Settings Success” message does not appear, contact your clinician immediately.

# CLEANING AND MAINTENANCE

You should regularly carry out the cleaning and maintenance described in this section. Refer to your mask manual for detailed instructions.

## DAILY CLEANING

### Mask

Clean the mask according to the instructions supplied with the mask.

### Air tubing

Disconnect the air tubing from the **S8 ESCAPE** (and humidifier, if used) and hang the tubing and mask in a clean, dry place until next use.

### Humidifier

If you are using a humidifier, clean it according to the instructions in the humidifier user's manual.

## WEEKLY CLEANING

1. Remove the air tubing from the **S8 ESCAPE** and the mask.
2. Wash the air tubing in warm water using mild detergent. Rinse thoroughly, hang, and allow to dry.
3. Before next use, assemble the mask and headgear according to the user instructions.
4. Reconnect the air tubing to the air outlet and mask.

## PERIODIC CLEANING

1. Clean the exterior of the **S8 ESCAPE** with a damp cloth and mild detergent.
2. Check the air filter for blockage or holes (see "Replacing the Air Filter" on page 23).



### WARNING

- Beware of electric shock. Do not immerse the unit or power cord in water. Always unplug the unit before cleaning and be sure it is dry before plugging back in.
- The mask system and air tubing are subject to normal wear and tear. Inspect them regularly for damage.

## REPLACING THE AIR FILTER

To replace the air filter:

1. Remove the air filter cover at the back of the S8 ESCAPE.

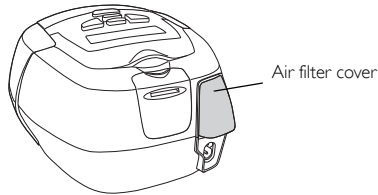

2. Remove and discard the old air filter.
3. Insert a new filter with the blue tinted side facing out from the device.
4. Replace the air filter cover.

Inspect the air filter every month to check if it is blocked by dirt or contains holes. With normal use of an S8 ESCAPE, the air filter needs to be replaced every six months (or more often if your device is in a dusty environment).

### **WARNING**



- Do not wash the air filter. The air filter is not washable or reusable.
- The air filter cover protects the device in the event of accidental liquid spillage onto the device. Ensure the air filter and air filter cover are fitted at all times.

## SERVICING

### **CAUTION**



- Do not attempt to open the S8 Escape case. There are no user serviceable parts inside.
- Inspection and repair should only be performed by an authorized agent. Under no circumstances should you attempt to service or repair the flow generator yourself.

This product (S8 ESCAPE) should be inspected by an authorized ResMed Service Center five years from the date of manufacture. Prior to this, the device is intended to provide safe and reliable operation provided that it is operated and maintained in accordance with the instructions provided by ResMed. Applicable ResMed warranty details are provided with the device at the time of original supply. Of course, as with all electrical devices, if any irregularity becomes apparent, you should exercise caution and have the device inspected by an Authorized ResMed Service Center.

If you feel that your flow generator is not performing properly, see "Troubleshooting" on page 26.



# FREQUENTLY ASKED QUESTIONS

## **HOW WILL IT FEEL WHEN I AM BREATHING WITH THE S8 ESCAPE?**

When you first use your S8 ESCAPE, you may feel uncomfortable breathing against the airflow. This is normal. You will continue to breathe normally while you sleep. Take time to adjust to this new sensation.

## **WHAT DO I DO WHEN I WANT TO GET UP IN THE NIGHT?**

If you need to get up during the night, remove your mask and stop therapy. Always remember to restart therapy and put your mask on when you return to bed.

## **WHAT DO I DO IF I FEEL AIR LEAKING OUT OF THE MASK?**

The flow generator delivers the most effective treatment when the mask is well fitted and comfortable. Treatment can be affected by leaks, so it is important to eliminate any leaks that may arise. For example, try repositioning the mask and adjusting the straps.

If you are using a nasal mask, try to keep your mouth closed during treatment. Air leaks from your mouth can decrease the effectiveness of your treatment. If mouth leaks are a problem, a full face mask or chin strap may help. Contact your clinician or equipment supplier for further details.

If you are using a full face mask and you have problems trying to get a comfortable mask fit, contact your sleep clinic or equipment supplier. You may benefit from a different size or style of mask.

## **ANYTHING SPECIAL I SHOULD DO BEFORE PUTTING THE MASK ON?**

Before wearing your mask, wash your face to remove excess facial oils. This will allow a better fit and prolong the life of the mask cushion.

Do not use moisturizer when wearing a mask.

## **MY MOUTH FEELS DRY DURING TREATMENT—WHAT CAN I DO?**

You may experience dryness of the nose, mouth, and/or throat during the course of treatment, especially during winter. In many cases, a humidifier may resolve this discomfort. Contact your clinician for advice.

## **MY NOSE IS IRRITATED DURING TREATMENT—WHAT CAN I DO?**

You may experience sneezing and/or a runny or blocked nose during the first few weeks of treatment. In many cases, nasal irritation can be resolved with a humidifier. Consult your clinician or equipment supplier for advice.

## **CAN I TRAVEL WITH THE S8 ESCAPE?**

### **International use**

Your S8 ESCAPE flow generator has an internal power supply that enables it to operate in other countries. It will operate on power supplies of 100–240 V and 50/60 Hz. No special adjustment is necessary, but you may need a plug adapter for the power outlet.

**Altitude changes**

If you are moving or traveling to a higher or lower altitude, see "How to change the Altitude setting" on page 17.

**On an aircraft**

Please consult the medical services department of your carrier if you intend to use your S8 ESCAPE on an aircraft. The S8 ESCAPE complies with US FCC Part 15, Class B requirements.

**Note:** Do not use your S8 Escape while the aircraft is taking off or landing.

**CAN I USE MY S8 ESCAPE IF MAINS (AC) POWER IS NOT AVAILABLE?**

A DC-12 converter is available to connect the S8 ESCAPE to a 12V or 24V DC power source. Contact your clinician for details.

**CAUTION**

The device should not be connected to both AC and DC power sources simultaneously.

# TROUBLESHOOTING

If there is a problem, try the following suggestions. If the problem cannot be solved, contact your equipment supplier or ResMed. Do not attempt to open the device.

<b>Problem</b>	<b>Possible Cause</b>	<b>Solution</b>
<i>No display.</i>	Power not connected.	Ensure the appropriate power cord is connected to your S8 Escape and the power switch (if available) is on.
<i>Insufficient air delivered from S8 Escape.</i>	Ramp Time is in use.	Wait for air pressure to build up or change ramp time.
	Air filter is dirty.	Replace air filter.
	Air tubing is kinked or punctured.	Straighten or replace tubing.
	Air tubing not connected properly.	Check air tubing.
	Mask and headgear not positioned correctly.	Adjust position of mask and headgear.
	Cap(s) missing from access port(s) on mask.	Replace cap(s).
	Altitude compensation setting is incorrect.	Adjust altitude compensation setting to the correct altitude range.
	Pressure required for treatment may have changed.	See your clinician to adjust the pressure.
<i>Excessive air delivered from the S8 Escape.</i>	Altitude compensation setting is incorrect.	Adjust altitude compensation setting to the correct altitude range.

Problem	Possible Cause	Solution
<p><i>Display error message:</i>  <b>Exxxx</b>  <b>Call Service</b>            (where <b>xxxx</b> defines an error)            or  <b>MOTOR FAULT</b>  <b>Call Service</b>            or  <b>UPLOAD LANGUAGES</b>  <b>Call Service</b>            or  <b>DATA LOST</b>  <b>Call Service</b></p>	Component failure.	Call Service.
<p><i>The following message is displayed on the LCD after you try to update settings using the Data Card:</i>  <b>Card Error</b>  <b>Remove Card</b></p>	The Data Card is not inserted correctly.	Ensure that the Data Card is inserted with the arrow facing up and pointing towards the device. Ensure that the device is switched on and in standby mode before you insert the Data Card.
	The Data Card is only partly inserted.	Ensure that the Data Card is inserted into the slot on the Data Card module as far as it will go.
	You may have removed the Data Card before settings were copied to the S8 Escape.	Reinsert the Data Card and wait for the <b>Settings Success Remove Card</b> message to appear on the LCD.
	The card is not a ResScan Data Card.	Only use a ResScan Data Card.
<p><i>The following message is displayed on the LCD after you try to copy data to a Data Card:</i>  <b>Card Error</b>  <b>Remove Card</b></p>	The Data Card is not inserted correctly.	Ensure that the Data Card is inserted with the arrow facing up and pointing toward the device.
	The card is not a ResScan Data Card.	Use a ResScan Data Card, as specified in this manual.
<p><i>The following message is displayed on the LCD after you try to update the settings using the Data Card:</i>  <b>Settings Invalid</b>  <b>Remove Card</b></p>	The identification details on the Data Card do not match the details on your device.	Contact your clinician immediately.

Problem	Possible Cause	Solution
<p><i>The following message is displayed on the LCD after you try to update the settings using the Data Card:</i>  <b>Settings Error</b>  <b>Remove Card</b></p>	<p>There is a data error on the Data Card.</p>	<p>Contact your clinician immediately.</p>
<p><i>The following message is NOT displayed on the LCD after you try to update the settings using the Data Card:</i>  <b>Settings Success</b>  <b>Remove Card</b></p>	<p>The settings were not updated.</p>	<p>Contact your clinician immediately.</p>

# SYSTEM SPECIFICATIONS

## S8 ESCAPE

**Performance:** Operating pressure range: 4 to 20 cm H<sub>2</sub>O

**Dimensions (H x W x D):** 4.6" x 6.5" x 5.7" (112 mm x 164 mm x 145 mm)

**Weight:** 2.9lb (1.3 kg)

### Power Supply

- Input range for S8 ESCAPE with HUMIDAIRE 3i: 100–240V, 50/60Hz; 110V, 400Hz; 2.5A < 140VA (110W) (maximum power consumption). Instantaneous peak power consumption <340 VA.
- Refer to the DC-12 converter instructions for DC ratings. Only use the ResMed DC-12 converter for DC input.

Actual power consumption will vary, depending on factors such as the use of accessories, height above sea level, and ambient temperature. Power consumption values for typical treatment conditions (using a breathing machine set to 0.5 L and 15 breaths/min with 2 m (6'6") air tubing and an ULTRA MIRAGE mask) are given in the following table.

Device	Pressure (cm H <sub>2</sub> O)	Power (VA)	Power (W)
S8 ESCAPE	5	17	8
	10	23	12
	15	29	16
	20	34	20

### Power outlet for HumidAire 3i

Outlet range: 100–240V, 50/60Hz; 110V, 400Hz; 2.0A

**Air Filter:** Two-layered, powder-bonded, polyester non-woven fiber

**Air Tubing:** Flexible plastic, 6'6" (2 m)

**Air Outlet:** The 22 mm conical outlet complies with EN 1281-1

**IEC 60601-1 Classifications:** Class II (double insulation), Type CF

**Noise Level:** Radiated sound pressure is measured at <30dBA at 10 cm H<sub>2</sub>O and 3'3.36" (1 m) according to ISO17510-1.

## ACCESSORIES

### DATA CARD

**Dimensions (L x W x D):** 2.56" x 0.87" x 0.03" (65.04 mm x 22.15 mm x 0.85 mm)

## DATA CARD MODULE

**Dimensions (H x W x D):** 1.95" × 1.66" × 0.47" (49.7 mm × 42.2 mm × 12 mm)

### ALL DEVICES (WHERE APPLICABLE)

**Housing Construction:** Flame retardant engineering thermoplastic

#### Environmental Conditions

Operating Temperature: +41°F to +104°F (+5°C to +40°C)

Operating Humidity: 10%–95% non-condensing

Storage and Transport Temperature: -4°F to +140°F (-20°C to +60°C)

Storage and Transport Humidity: 10%–95% non-condensing

Operating Altitude: sea level to 8500' (2591 m)

#### Electromagnetic Compatibility

Product complies with all applicable electromagnetic compatibility requirements (EMC) according to IEC60601-1-2, for residential, commercial, and light industry environments. For further details, see "Guidance and Manufacturer's Declaration - Electromagnetic Emissions and Immunity" on page 31.

**Note:** *The manufacturer reserves the right to change these specifications without notice.*

### SYMBOLS WHICH APPEAR ON THE DEVICE



Attention, consult accompanying documents



Type CF equipment



Class II equipment



IPX1

Drip proof



Dangerous voltage



Start/Stop

## GUIDANCE AND MANUFACTURER'S DECLARATION - ELECTROMAGNETIC EMISSIONS AND IMMUNITY

### Guidance and manufacturer's declaration—electromagnetic emissions

The S8 series of devices is intended for use in the electromagnetic environment specified below. The customer or the user of the S8 device should assure that the device is used in such an environment.

Emissions test	Compliance	Electromagnetic environment—guidance
RF emissions CISPR11	Group 1	The S8 device uses RF energy only for its internal function. Therefore, its RF emissions are very low and are not likely to cause any interference in nearby electronic equipment.
RF emissions CISPR 11	Class B*	The S8 device is suitable for use in all establishments, including domestic establishments and those directly connected to the public low-voltage network that supplies buildings used for domestic purposes.
Harmonic Emissions IEC 61000-3-2	Class A	
Voltage Fluctuations/Flicker Emissions IEC 61000-3-3	Complies	

\* Class B for all system configurations except when a PC is attached to the S8 device via a serial adapter, in which case the system is Class A compliant. Class A is suitable for use in all establishments other than domestic and those directly connected to a low voltage power supply network which supplies buildings used for domestic purposes.

Medical Electrical Equipment needs special precautions regarding EMC and needs to be installed and put into service according to EMC information provided in this document.

**Warnings:** The S8 device should not be used adjacent to or stacked with other equipment. If adjacent or stacked use is necessary, the S8 device should be observed to verify normal operation in the configuration in which it will be used.

The use of accessories (eg humidifiers) other than those specified in this manual is not recommended. They may result in increased emissions or decreased immunity of the S8 device.



## Guidance and manufacturer's declaration—electromagnetic immunity

The S8 series of devices is intended for use in the electromagnetic environment specified below. The customer or the user of the S8 device should assure that the device is used in such an environment.

Immunity test	IEC60601-1-2 test level	Compliance level	Electromagnetic environment—guidance
Electrostatic discharge (ESD) IEC 61000-4-2	±6 kV contact  ±8 kV air	±6 kV contact  ±8 kV air	Floors should be wood, concrete or ceramic tile. If floors are covered with synthetic material, the relative humidity should be at least 30%.
Electrical fast transient/burst IEC 61000-4-4	±2 kV for power supply lines  ±1 kV for input/output lines	±2 kV  Not Applicable	Mains power quality should be that of a typical commercial or hospital environment.
Surge IEC 61000-4-5	±1 kV differential mode  ±2 kV common mode	±1 kV differential mode  ±2 kV common mode	Mains power quality should be that of a typical commercial or hospital environment.
Voltage dips, short interruptions and voltage variations on power supply input lines. IEC 61000-4-11	<5% $U_t$ (>95% dip in $U_t$ ) for 0.5 cycle  40% $U_t$ (60% dip in $U_t$ ) for 5 cycles  70% $U_t$ (30% dip in $U_t$ ) for 25 cycles  <5% $U_t$ (>95% dip in $U_t$ ) for 5 sec	< 12V (>95% dip in 240V) for 0.5 cycle  96V (60% dip in 240V) for 5 cycles  168V (30% dip in 240V) for 25 cycles  <12V (>95% dip in 240V) for 5 sec	Mains power quality should be that of a typical commercial or hospital environment. If the user of the S8 device requires continued operation during power mains interruptions, it is recommended that the S8 device be powered from an uninterruptible power source.
Power frequency (50/60 Hz) magnetic field IEC 61000-4-8	3 A/m	3 A/m	Power frequency magnetic fields should be at levels characteristic of a typical location in a typical commercial or hospital environment.

NOTE:  $U_t$  is the AC mains voltage prior to application of the test level.

Guidance and manufacturer’s declaration—electromagnetic immunity

The S8 series of devices is intended for use in the electromagnetic environment specified below. The customer or the user of the S8 device should assure that the device is used in such an environment.

Immunity test	IEC60601-1-2 test level	Compliance level	Electromagnetic environment—guidance
<p>Conducted RF IEC 61000-4-6</p> <p>Radiated RF IEC 61000-4-3</p>	<p>3 Vrms 150 kHz to 80 MHz</p> <p>10 V/m 80 MHz to 2.5 GHz</p>	<p>3 Vrms</p> <p>10 V/m</p>	<p>Portable and mobile RF communications equipment should be used no closer to any part of the S8 device, including cables, than the recommended separation distance calculated from the equation applicable to the frequency of the transmitter.</p> <p><b>Recommended separation distance</b></p> <p><math>d = 1.17 \sqrt{P}</math></p> <p><math>d = 0.35 \sqrt{P}</math> 80 MHz to 800 MHz</p> <p><math>d = 0.70 \sqrt{P}</math> 800 MHz to 2.5 GHz</p> <p>where P is the maximum output power rating of the transmitter in watts (W) according to the transmitter manufacturer and d is the recommended separation distance in meters (m). Field strengths from fixed RF transmitters, as determined by an electromagnetic site survey,<sup>a</sup> should be less than the compliance level in each frequency range.<sup>b</sup></p> <p>Interference may occur in the vicinity of equipment marked with the following symbol:</p> 

NOTE 1: At 80 MHz and 800 MHz, the higher frequency range applies.

NOTE 2: These guidelines may not apply in all situations. Electromagnetic propagation is affected by absorption and reflection from structures, objects and people.

<sup>a</sup> Field strengths from fixed transmitters, such as base stations for radio (cellular/cordless) telephones and land mobile radios, amateur radio, AM and FM radio broadcast and TV broadcast cannot be predicted theoretically with accuracy. To assess the electromagnetic environment due to fixed RF transmitters, an electromagnetic site survey should be considered. If the measured field strength in the location in which the S8 device is used exceeds the applicable RF compliance level above, the S8 device should be observed to verify normal operation. If abnormal performance is observed, additional measures may be necessary, such as reorienting or relocating the S8 device.

<sup>b</sup> Over the frequency range 150 kHz to 80 MHz, field strengths should be less than 10 V/m.

## Recommended separation distances between portable and mobile RF communications equipment and the S8 series of devices

The S8 series of devices is intended for use in an environment in which radiated RF disturbances are controlled. The customer or the user of the S8 device can help prevent electromagnetic interference by maintaining a minimum distance between portable and mobile RF communications equipment (transmitters) and the S8 device as recommended below, according to the maximum output power of the communications equipment.

Rated maximum output power of transmitter W	Separation distance according to frequency of transmitter m		
	150 kHz to 80 MHz $d = 1.17 \sqrt{P}$	80 MHz to 800 MHz $d = 0.35 \sqrt{P}$	800MHz to 2.5 GHz $d = 0.7 \sqrt{P}$
0.01	0.17	0.04	0.07
0.1	0.37	0.11	0.22
1	1.17	0.35	0.7
10	3.69	1.11	2.21
100	11.70	3.50	7.0

For transmitters rated at a maximum output power not listed above, the recommended separation distance  $d$  in metres (m) can be determined using the equation applicable to the frequency of the transmitter, where  $P$  is the maximum output power rating of the transmitter in watts (W) according to the transmitter manufacturer.

NOTE 1: At 80 MHz and 800 MHz, the separation distance for the higher frequency range applies.

NOTE 2: These guidelines may not apply in all situations. Electromagnetic propagation is affected by absorption and reflection from structures, objects and people.

# LIMITED WARRANTY

ResMed warrants that your ResMed product shall be free from defects in material and workmanship for the period specified below from the date of purchase by the initial consumer. This warranty is not transferable.

Product	Warranty Period
ResMed humidifiers, ResControl™, ResLink™	1 Year
ResMed flow generators	2 Years
Accessories, mask systems (including mask frame, cushion, headgear and tubing). Excludes single-use devices.	90 Days

**Note:** Some models are not available in all regions.

If the product fails under conditions of normal use, ResMed will repair or replace, at its option, the defective product or any of its components. This Limited Warranty does not cover:

- a) any damage caused as a result of improper use, abuse, modification or alteration of the product;
- b) repairs carried out by any service organization that has not been expressly authorized by ResMed to perform such repairs;
- c) any damage or contamination due to cigarette, pipe, cigar or other smoke;
- d) any damage caused by water being spilled on or into a flow generator.

To make a warranty claim, the initial consumer must return the defective product to the point of purchase, freight prepaid.

This warranty is in lieu of all other express or implied warranties, including any implied warranty of merchantability or fitness for a particular purpose. Some regions or states do not allow limitations on how long an implied warranty lasts, so the above limitation may not apply to you.

ResMed shall not be responsible for any incidental or consequential damages claimed to have occurred as a result of the sale, installation or use of any ResMed product. Some regions or states do not allow the exclusion or limitation of incidental or consequential damages, so the above limitation may not apply to you. This warranty gives you specific legal rights, and you may also have other rights which vary from region to region.

For further information on your warranty rights, contact your local ResMed dealer or ResMed office.

R001-307/1 05 02



# INDEX

## A

- accessories 10
- air filter 9, 26
  - replacing 23
- air pressure 26
- air tubing 9
  - cleaning 22
  - connect to air outlet 11
  - kinked 26
  - positioning 12
- aircraft 25
- airflow
  - breathing with 24
- altitude setting 17, 25, 26

## B

- backlight
  - LCD and keypad 15

## C

- carry bag 9
- cleaning
  - periodic 22
- contraindications 6
- CPAP 5

## D

- daily cleaning 22
- Data Card 19
  - copying data 20
  - inserting 20
  - mailback envelope 20
  - removing 20
- data card 27
- Data Card module 19
- DC-12 converter 25
- down key 15
- dryness
  - mouth, nose or throat 24

## E

- error message 27

## F

- frequently asked questions 24

## H

- headgear 26

## HumidAire

- attaching 13
- HumidAire 3i
  - attaching 13
  - storage 9
- humidifier 24
  - cleaning 22
- humidifiers 10

## I

- international use 24

## K

- keypad 9, 15
- keypad keys
  - functions 15

## L

- language setting 17
- LCD 9, 11, 15
  - error messages 27
  - messages 18
- left key 15

## M

- mailback envelope 20
- mask 24, 26
  - air leak 24
  - attaching 11
  - cleaning 22
  - removing 24
- mask leak 24
- mask port 26
- masks 9
- medical information 5
- menu screens 16
  - access 16
  - change 16
  - exit 17
  - scrolling 16
- module
  - attaching 9
  - blank 19
  - Data Card 19
- modules 19
  - blank 19

## **N**

nasal irritation 24

## **P**

Passover

attaching 14

power cord 9, 26

connecting 11

power sockets 9

power sources 25

power supply 29

## **R**

ramp time 12, 17, 26

reminder

replace mask 18

reminders 18

ResScan Data Card module 10

right key 15

## **S**

S8 Escape

dimensions 29, 30

servicing 23

settings 16

set-up 11

start treatment 12

stop treatment 12

travelling with 24

setting up 11

software version number 17

standby screen 11

start/stop key 15

SW 17

system specifications 29

## **T**

troubleshooting 26

## **U**

up key 15

Usage 17

use on aircraft 25

Used hours 17

## **W**

weekly cleaning 22

## Free Manuals Download Website

<http://myh66.com>

<http://usermanuals.us>

<http://www.somanuals.com>

<http://www.4manuals.cc>

<http://www.manual-lib.com>

<http://www.404manual.com>

<http://www.luxmanual.com>

<http://aubethermostatmanual.com>

Golf course search by state

<http://golfingnear.com>

Email search by domain

<http://emailbydomain.com>

Auto manuals search

<http://auto.somanuals.com>

TV manuals search

<http://tv.somanuals.com>