

REVOX

**Re:connect
M 219**

**Additional
room amplifier**

Dominating Entertainment.
Revox of Switzerland.

Contents

M219 Additional room amplifier	2
Safety	3
Installation and operation	3
Safety measures	4
Warranty	4
<hr/>	
Front view	5
Connection plan	6
Detailed description	7
[1] Local IN 1 2 3	7
[2] PRE OUT	7
[3] DIL Setup switches	8
(1) IR receiver	8
(2) Pre Out	9
(3) Input IN	10-11
(4-5) Local inputs	12
(6-7-8) Addressing	12
[4] M219 Link	13
[5] IR Link	13
[6] Input IN	14
[7] Channel Select	14-15
[8] IN Revox MR Bus	15
[9] OUT Revox MR Bus	15
[10] R-L Speakers	16
[11] Fuse	16
[12] AC Power	16
<hr/>	
M219 cabling plan diagram	17
Multiroom Cabling	18
Personal M219 settings	18
Technical data	19
Guarantee	20
Delivered items	20

M219

Additional room amplifier

General

The M219 is a digital Additional Room Amplifier from the newest M Series in the **REVOX** Multiroom programme. It is used for the reproduction of music in the additional rooms in a Multiroom system and can also supply the listener with current information through an additional display. The **M219** receives the signals from a selected source (CD, Tuner, Server ...) in the main room through a multiroom bus cable. Volume, balance, bass and treble settings can be made in individually in each room. Also, up to 3 local sources can be connected and listened to in each additional room. If you want "concealed" operation, various wall-mounted controllers or IR receivers can be connected.

Installation

The **M219** should be installed in such a way that the ventilation slots are not covered up and so that there is a gap of at least 5 cm (\approx 2 in) between the unit and any walls or furniture.

You should avoid installing it in locations where:

- there is direct sunlight
- it is next to a heat source
- there is poor ventilation
- there is a lot of dust in the atmosphere
- it is unstable
- there is a risk of splashing
- there is high humidity

Furthermore you may not place objects filled with liquids, such as vases, or naked flame sources, such as lighted candles, on the **M219**.

Stacking several M219s

If you want to stack several **M219s** on top of each other, we recommend that you use the corresponding installation kit, with the **Part no. 1.551.313.00**.

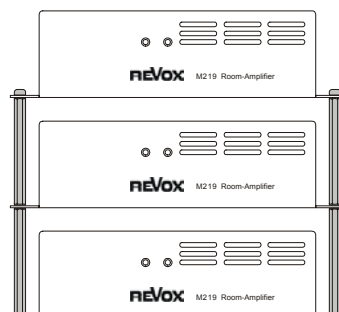

Safety

Please take note of the information shown on the labels on the rear of the unit. Housings should not be removed, in order to avoid the danger of an electric shock. Maintenance and repairs should only be carried out by qualified personnel.

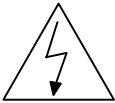

This symbol warns of “dangerous voltages” within the unit. In the case of contact with the corresponding components, the level of voltage can cause an electric shock.



This symbol indicates important advice for operation and maintenance in this documentation.

Installation and operation

Please check the unit and accessories for any signs of transit damage, once you have unpacked it. Please read the operating instructions carefully before starting to use the unit. Keep the documentation somewhere safe for future reference.

If the unit shows any signs of damage or has come into contact with any fluids should not be connected to a power supply.

Only use the power cable supplied. Before connecting the power, the power supply and unit connection values (power voltage, frequency) must be checked. The fuse used in the unit must conform to the factory definitions contained in the “Technical data” section of this manual.

Safety measures

Operational anomalies

In the case of any unusual noises or smells coming from the unit, remove the power cable immediately. Have the unit checked as soon as possible by your supplier.

Do not open the unit

The unit should not be opened because of the risk of electrocution.

Periods of non-use

If the unit is not going to be used for a longer period of time, the power cable should be unplugged from the socket as a safety precaution.

Foreign objects

Fluids, flammables or other foreign objects should not find their way into any of the unit's openings as this can result in breakdowns, fire or an electric shock.

Power cable

Always pull the plug out of the socket while holding the plug housing and not the cable.

Warranty

Device regulations

REVOX offers a warranty in EU/EEA countries on products bought within the EU, in addition to the statutory warranty provided by the retailer. The warranty covers material and labour during the period of the warranty, which is stipulated in the individual EU countries by the **REVOX** Sales Partners.

In all countries, the terms of warranty from the **REVOX** reseller is offered in addition to the statutory regulations. You must be able to prove that the product was bought from an approved **REVOX** Partner when making any warranty claim.

The warranty is invalidated if any inappropriate or unprofessional repairs have been carried out on the unit.

M219- Front view

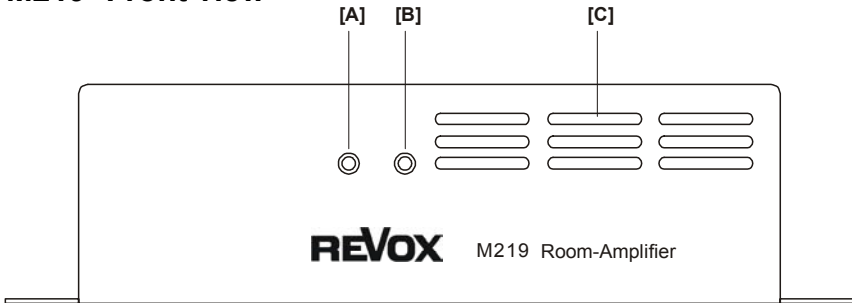

[A] IR Sensor

The InfraRed sensor receives signals from the remote control or from any other IR control devices, such as the PDAs for the music server.

Switching the IR sensor off

If required, the IR sensor can be switched off using the SETUP DIL switch [3] on the rear of the **M219**.

[C] Ventilation slots

The ventilation slots on the front and the top of the **M219** must always be left clear of obstructions.

The **M219** should be installed in such a way that the ventilation slots are not covered up and so that there is a gap of at least 5cm between the unit and any walls or furniture.

[B] Status LED

The blue status LED gives information about the current state of the **M219**.

LED display	M219 Status
Permanently dark	M219 standby mode
Permanently lit	M219 active
Rapid flashing	Breakdown, overload
Rapid flashing	Min/max position reached (Volume, Bass, Treble, Balance)
Slow flashing	IR receive (RC5 or RC6 Codes)
Single flash	LOCAL 1 or general change of source
Double flash	LOCAL 2
Triple flash	LOCAL 3

Connection plan

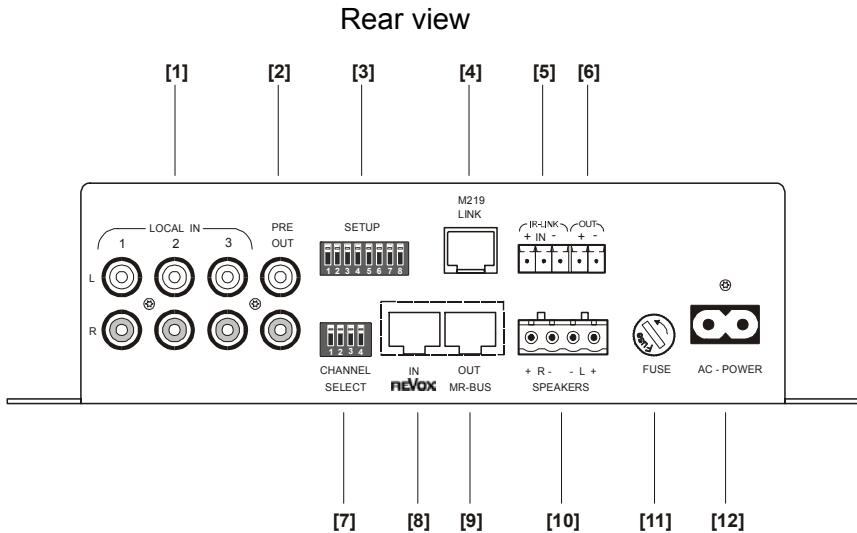

Short descriptions

- | | |
|--|------------------------------|
| [1] Local Cinch inputs L/R | [7] Stereo/ Mono switch |
| [2] Preamp outputs L/R | [8] Multiroom Bus input |
| [3] DIL setup switches | [9] Multiroom Bus output |
| [4] M219-Link display connector | [10] Speaker connections L/R |
| [5] IR receiver or wall-mounted remote control connections | [11] Fuse |
| [6] Switching voltage input | [12] Power connection |

Detailed descriptions

[1] LOCAL IN 1 2 3

Local Cinch inputs L/R

The **M219** has 3 local line inputs for a CD player, video recorder or TV, for example, which are located directly in the room where the M219 is. The local audio inputs are activated by the **Local** key on the (wall-mounted) remote control. You can scroll through a loop of the local inputs by repeatedly pressing the **Local** key:

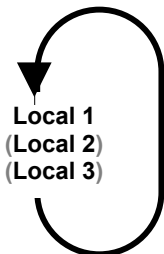

The number of active inputs that are actually used can be set through Setup DIL switches 4 & 5. This saves you unnecessary scrolling through non-active inputs. If, for example, only inputs 1 and 2 are used, you can set the switches so that you only have to scroll through Inputs 1 & 2. Input 3 is skipped.

[2] PRE OUT

Preamp outputs L/R

Using the **M219s** preamp outputs, additional output devices can be supplied, or the **REVOX** digital speakers can be operated through the **REVOX** DLC-2.

The configuration of this audio output is described in detail on *Page 9*.

[3] SETUP

DIL Setup switches

The basic settings of the **M219** are configured through these DIL setup switches.

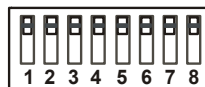

Important

Configuration can only be carried out through the setup switches when the M219 is disconnected from the power supply. Otherwise, the new settings are not activated.

The function of each individual switch is described on the next page. ⇨

DIL setup switches

NO	Function	Factory setting
1	M219 IR eye on/off	On
2	Pre-Out: Fixed Volume	Off
3	LOCAL IN 1 → Fixed Volume	Off
4	Number of local inputs	On
5	Number of local inputs	On
6	M219 address	Off
7	M219 address	Off
8	M219 address	Off



Please note:

The switch is in the **ON** position when it is down

You can enter your own personal DIL switch settings in a table included on the last pages of this manual, providing you with a record for future reference.

M219 infrared receiver

In some cases, e.g. in buildings with glass internal walls, it can be useful to switch the **M219** IR receiver off, in order to avoid operational conflicts with other devices.

IR Function	DIL switch 1	DIL position
IR - Off	Off	 1
IR - On	On	 1

(2) PRE OUT

Two operating modes are possible with the **M219**'s preamp output:

Floating Volume (Factory setting from serial # 2000):



This is the standard mode setting. In this case, the PRE OUT level changes parallel to the speaker level. This means that as you increase the volume at the speakers, for example, the PRE OUT level is automatically changed at the same time.

Application: You should select *Floating Volume* mode if, for example, an additional output device or an active subwoofer is connected, whose volume should also be controlled by the **M219**. This means that the **M219** speaker output remains active.

Fixed Volume:

In this mode, the volume control and the **M219** output devices are deactivated, i.e. the volume cannot be controlled by any wall-mounted or infrared remote control. The speakers connected to the **M219** remain silent. Irrespective of whether it is addressed through the multiroom bus or a local input (*Local IN 1 2 3*), each source has a standard level, the so-called Line Level.

Application: The *Fixed Volume* mode has been conceived principally for applications where digital **REVOX** speakers are to be connected to the **M219** over a **DLC2** interface.



PRE OUT	DIL switch 2	DIL position
Floating Volume	Off	
Fixed Volume	On	

(3) Voltage input IN (from serial # 2000)

Using the voltage input **IN** on the **M219**, the local audio input **LOCAL IN 1** can be activated by the application of 5 – 24 VDC. This means that as soon as the voltage is present at **IN**, the **M219** switches on automatically and selects the input **LOCAL IN 1**. When the voltage is removed from input **IN**, the **M219** switches off again automatically, as long as no other source apart from **LOCAL IN 1** was addressed.

With DIL switch (3), you can define whether the volume control is handled by the **M219** (*Floating Volume*) or the connected (TV) device (*Fixed Volume*). With *Fixed Volume*, the **M219**'s volume control is deactivated and the audio signal at **LOCAL IN 1** is transmitted with a fixed strength. In this way, volume control is carried out with the TV remote control.

The volume control setting set by DIL switch 3 only has an effect on the local audio input **LOCAL IN 1**. All other sources are unaffected and operate normally.

LOCAL IN 1	DIL switch 3	DIL position
Floating Volume	Off	 3
Fixed Volume	On	 3

Application: Many devices output a voltage as soon as they are switched on. If you connect the voltage output of such a device with the **IN** voltage input on the **M219** and the audio output with the local audio input **LOCAL IN 1**, the **M219** will switch on automatically with the other device and transmit the sound.

If your device **doesn't** have a voltage output, you can supply voltage to the input using a sensor-switch multiple socket outlet (Master/Slave socket outlet) and a normal plug-in power supply (5-24 V = / DC). Please refer to the diagram on Page 11.

Cabling: Voltage input IN

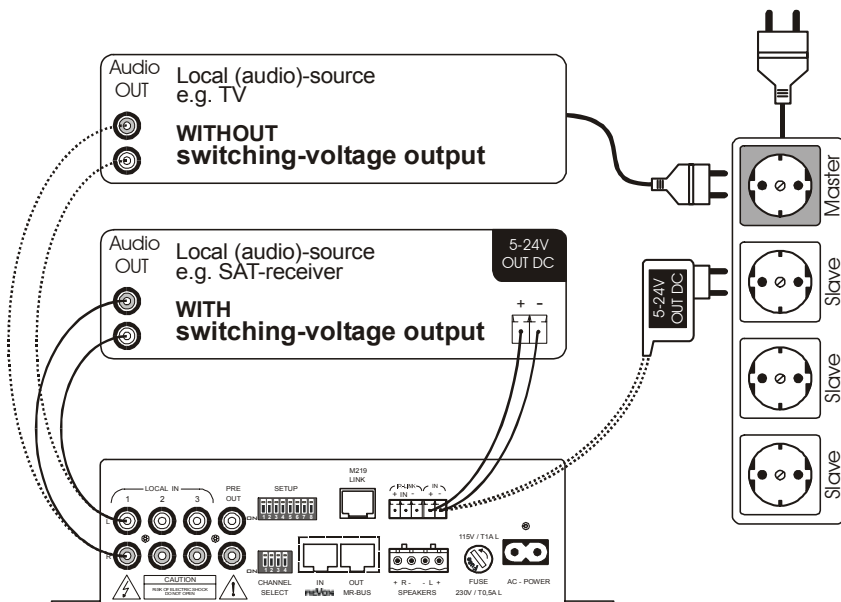

Please note: SCART sockets

Many devices such as SAT receivers, video recorders or DVD players output a switching voltage through the SCART socket as soon as they are switched on.

On a standard SCART socket, **PIN 8** outputs the positive voltage (+) and **PIN 4** or **14** is the earth (-).







The principle of Master/Slave socket outlets

With this type of socket outlets, the control device (the TV in the above example) is plugged into the master socket while all other devices are connected through the slave sockets. As long as the master device is not switched on, all slave sockets remain switched off. Once the master device is switched on, all the slave sockets (the plug-in power supply in the above example) are switched on at the same time.

In this way, you can “upgrade” any type of device to give it a switching-voltage output.

M219 local inputs









See description: [1] LOCAL IN 1 2 3

Number of local inputs	DIL switch 4	DIL switch 5	DIL position
0	Off	Off	
1	Off	On	
2	On	Off	
3	On	On	

M219 addressing

If you want to control each **M219** individually, to use the alarm function of the **M51 Timer**, for example, it is necessary to assign each **M219** its own address. The maximum number of **M219s** is limited to 8 per zone. All **M219s** must have different addresses within one zone as otherwise there may be communication problems.

The revision of a correct addressing is made in the Setup menu of the **M51**, category *Multiroom / Version*. All attached devices (**M219** and/or **M217**) must be listed in the respective zone.

Address	DIL switch 6	DIL switch 7	DIL switch 8	DIL position
1	Off	Off	Off	
2	Off	Off	On	
3	Off	On	Off	
4	Off	On	On	
5	On	Off	Off	
6	On	Off	On	
7	On	On	Off	
8	On	On	On	

[4] M219-Link**M217- Display connection**

The external display **M217** can be connected to the **M219-Link** connector, which can give the listener basic information about the current music programme.

Connection is made using a **straight through** (not crossed), 4-core telephone cable with an RJ11 plug (6P4C-Modular) connected to the **M219 LINK** socket.

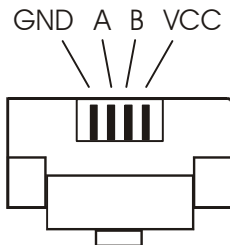

Front view of RJ11 Connector

*** Comment**

A 3-core cable with screening is recommended. In this case, no further cable would be necessary if you added an additional display at a later stage.

[5] IR-LINK**Connection for IR receiver or wall-mounted remote control**

If it is not possible or not required that the **M219** is controlled directly with a remote control, a wall-mounted remote controller (e.g. **M218**) or an external IR eye (**MR-204**) can be connected to the **IR-LINK** connector.

Connection to the IR receiver or the wall-mounted remote controller is made using a screwable Phoenix plug connector.

REVOX recommends the use of a 3-core, screened cable* (microphone cable), where the screening is used as an earth. This cable may not be longer than 40 meters. Please refer to the label for the correct cabling:

+ → Positive feed - *VCC*
IN → IR Signal - *Data*
 - → Earth - *GND*

the maximum number of IR receivers per **M219** is **5**.

IR commands

The **M219** accepts all RC5 or RC6 commands and carries out those that are intended for it. All others are transferred on to the Multiroom central unit.

[6] IN Voltage input (from serial # 2000)

Using the voltage input **IN** on the **M219**, the local audio input **LOCAL IN 1** can be activated by the application of 5 – 24 VDC. This means that as soon as the voltage is present at **IN**, the **M219** switches automatically to **LOCAL IN 1**, irrespective of which source had been selected previously.

For further information please refer to DIL switch (3) / Page 10.

Please note:

The voltage input IN is galvanically isolated from the M219 with a high-resistance (10kΩ) optical coupler. This stops any disturbances from either side having any effect.

[7] CHANNEL SELECT



Stereo/ Mono switch

Using the **Channel Select** switch, you can adjust the operating mode of the two music (stereo) channels, to the requirements of the room where the **M219** is installed. Three operating modes are available:

- 1) **Stereo**
The left music channel is reproduced through the left speaker connector and the right channel through the right connector.
- 2) **Inverse stereo**
After installation, it can occur that the left and right speaker connections have been inverted or that the sound picture is not correct for the normal listening position. In this case, a quick solution is offered with the **Inverse stereo** operating mode, which inverts the assignment of the left and right speaker connectors.
- 3) **Mono**
If only one speaker is connected to the **M219**, or if the **M219** is controlling two speakers, each in a different room, you should select the **Mono** operating mode. This means that each speaker receives all the music information.

The configuration of the Channel Select switches is described on the next page. ⇨

[7] CHANNEL SELECT**Configuration**

Operating mode	DIL- 1 Switch	DIL- 2 Switch	DIL- 3 Switch	DIL- 4 Switch	DIL Position
	Left channel		Right channel		
Stereo	On	Off	Off	On	
Inverse Stereo	Off	On	On	Off	
Mono	On	On	On	On	

You can change the switch settings during operation if the volume level is turned down low.

[8] IN REVOX MR-BUS**Multiroom Bus input**

Connection of the **REVOX** Multiroom Bus cable, which is connected to the Multiroom central unit e.g. **M51 MR Module MKII**.

Connection is made using a **screened and uncrossed RJ45 cable**.

[9] OUT REVOX MR-BUS**Multiroom Bus output**

Connection for a further **M219**, which is connected with a **REVOX** Multiroom Bus cable. **A maximum of 8 M219s** can be connected in this way.

Connection is made using a **screened and uncrossed RJ45 cable**.

[10] R – L SPEAKERS**Speaker connection**

Always use a cable of a sufficient diameter for connecting your speakers to the **M219**.

REVOX recommends:

up to 15 m:	Ø 1.50 mm ²
up to 30 m:	Ø 2.50 mm ²
over 30 m:	Ø 4.00 mm ²

We recommend not to use cables longer than 50, due to the unavoidable loss of HiFi reproduction.

Each individual speaker must have an impedance of 4 Ω or higher. You must ensure that all cable strands are within the screwable Phoenix connector and that none of them come into contact with any adjacent connectors or the **M219** housing.

You will only be assured of a perfect stage-quality reproduction if you ensure correct polarity when connecting. A wrong polarity will not cause any damage to the speaker or to the **M219**, but it can result in imprecise and diffused reproduction that is weak in the base ranges.

[11] FUSE**Fuse**

Always power the unit down before replacing the fuse.

When replacing the fuse, always use one of the same type as shown on the **M219** rating label.

Other fuse types with different power, voltage or operational characteristics can endanger your life and damage the unit.

The fuse holder can be removed by pushing it in slightly and then turning it in the direction of the arrow.

[12] AC-POWER**Power connection**

Only use the **REVOX** power cable supplied. You must also ensure that the power supply used delivers the voltage as shown on the **M219** rating label (240V). If required, the **M219** can be modified to work with other voltages. This modification should only be carried out by an authorised specialist.

M219 Cabling plan diagram

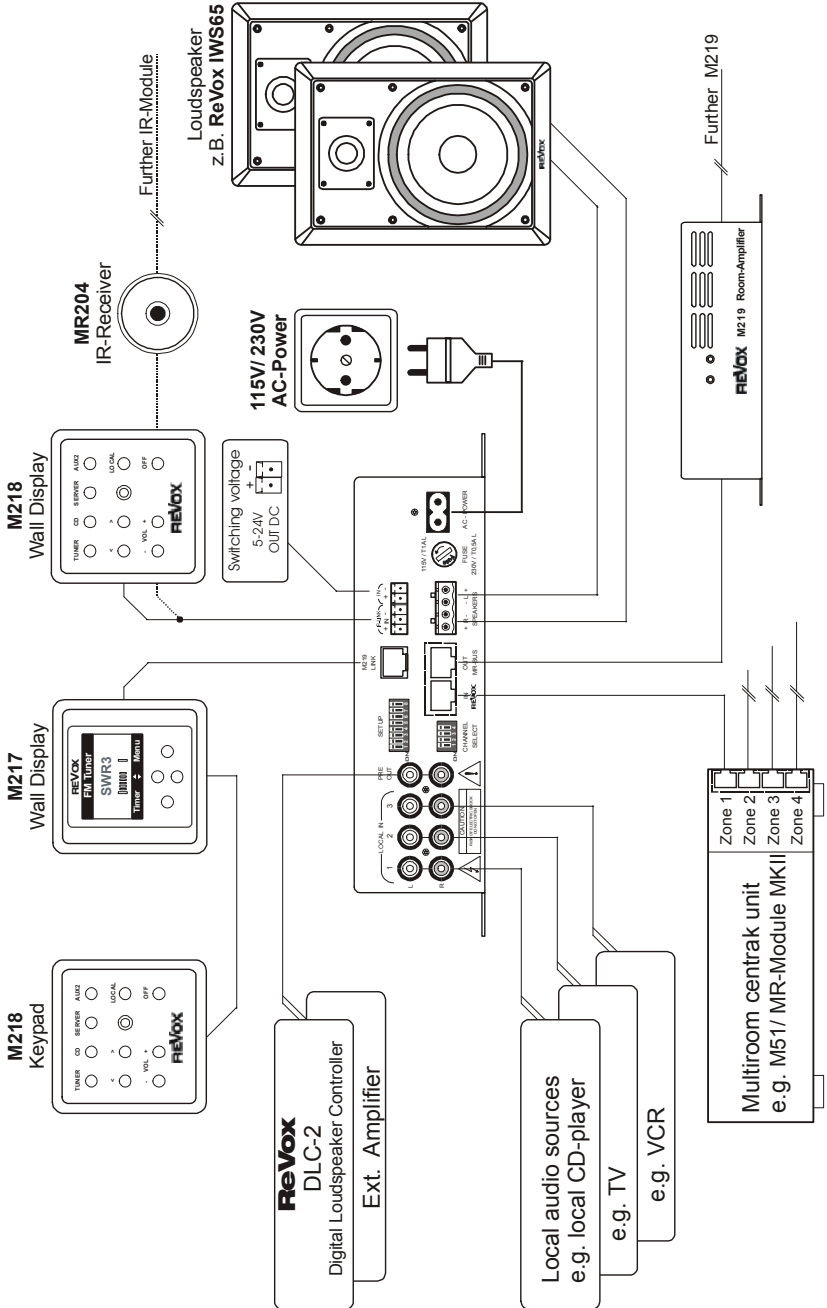

Multiroom cabling

Multiroom cabling uses a **CAT 7** cable, in accordance with the international network standard **EIA/TIA-568-B**.

This **EIA/TIA-568-B** standard provides for the following assignment:

The **CAT 7** cable is characterised by 4 twisted pairs, where each pair has its own screening. There is a complete screening around all four pairs.

Clamp	1	2	3	4	5	6	7	8
Colour code	wh/or	or	wh/gn	bl	wh/bl	gn	wh/bn	bn
MR-signal	RX	TX	L+	R+	R-	L-	GND	MR GND

Personal M219 Settings (DIL switches)

Room	DIL setup switches							
	1	2	3	4	5	6	7	8
	Off	Off	Off	Off	Off	Off	Off	Off
	On	On	On	On	On	On	On	On
	Off	Off	Off	Off	Off	Off	Off	Off
	On	On	On	On	On	On	On	On
	Off	Off	Off	Off	Off	Off	Off	Off
	On	On	On	On	On	On	On	On
	Off	Off	Off	Off	Off	Off	Off	Off
	On	On	On	On	On	On	On	On
	Off	Off	Off	Off	Off	Off	Off	Off
	On	On	On	On	On	On	On	On
	Off	Off	Off	Off	Off	Off	Off	Off
	On	On	On	On	On	On	On	On
e.g. Bedroom	X Off	Off	Off	X Off	X Off	X Off	Off	X Off
	On	X On	X On	On	On	On	X On	On

Technical data**Amplifier part:**

Music power:	2 x 50 Watt at 4 Ohm / 1% THD 2 x 25 Watt at 4 Ohm / RMS
Frequency range:	10 Hz - 25 kHz / -3 dB
Damping factor:	> 200 at 8 Ohm / 1 kHz
Harmonic distortion:	0.03 % at 10 Watt

General M219 data:

Power voltage:	230 V	115 V
Power fuse rating:	0.5 A time-lag	1 A time-lag
Power consumption:	Max. Operation: Standby:	115 Watt 7 Watt* 2 Watt

* at room volume without additional devices

Operating conditions: (Humidity rating acc. DIN 40040),
“+10°... +40°C” / “+50°...+104°F”

Dimensions:

Width:	225 mm	(8.86 in)
Height:	60 mm	(2.36 in)
Depth:	160 mm	(6.30 in)

Weight: 2.4 kg (5.3 lb)

Errors and technical modifications excepted.

Description: Version 0.90

Guarantee

The guarantee period is 24 months from the date of purchase.

Your dealer should be your first contact if you need service.

If he can't give you the help you need, send the **M219** carriage free and without any accessories to your national Sales Office.

Please supply a complete description of the problem and a full return postal address.

Delivered items

- **M219** Multiroom amplifier
- Power cable
- 1 RJ11 plug
- Operating instructions

Free Manuals Download Website

<http://myh66.com>

<http://usermanuals.us>

<http://www.somanuals.com>

<http://www.4manuals.cc>

<http://www.manual-lib.com>

<http://www.404manual.com>

<http://www.luxmanual.com>

<http://aubethermostatmanual.com>

Golf course search by state

<http://golfingnear.com>

Email search by domain

<http://emailbydomain.com>

Auto manuals search

<http://auto.somanuals.com>

TV manuals search

<http://tv.somanuals.com>