

# **REVOX**

**Re:control**

**M208  
System Remote  
Control**

Dominating Entertainment.  
Revox of Switzerland.

Version 1

<b>A General</b>	<b>A 2</b>
Remote control	<b>A 4</b>
MMC card	<b>A 5</b>
M208 Link	<b>A 6</b>
Synchronisation	<b>A 7</b>
<b>Operation</b>	<b>A 8</b>
M208 Base settings	A 8 - 12
<b>B TUNER</b>	<b>B 1</b>
Synchronising tuner stations	B 1
Operation	B 2
<b>C DVD</b>	<b>C 1-2</b>
<b>D TV</b>	<b>D 1-2</b>
<b>E SERVER</b>	<b>E 1</b>
Synchronising the music server	E 2
Operation	
Music selection	E 3-5
Repeat	E 6
Shuffle	E 6
M37 - Original	E 7-8
<b>F SAT</b>	<b>F 1-4</b>
<b>G VIDEO</b>	<b>G 1-2</b>
<b>H AUDIO</b>	<b>H 1-2</b>
<b>I LIGHT</b>	<b>I 1</b>
<b>J SOUND</b>	<b>J 1-2</b>
<b>K Appendix</b>	<b>K 1</b>
Troubleshooting	K 1
Technical data	K 2
Guarantee, Disposal, Scope of delivery	K 2

## **A General**

The M208 System Remote Control was developed based on the knowledge gained through our many years of experience and on the requests and requirements of our customers.

All current Revox products can be operated with the M208, both in the main room and in the additional rooms of a Multiroom system. As the commands are identical for each room, you can take your remote control with you from the living room to the kitchen and continue as normal.

But it's not just this ability to use the remote control in many different locations that makes the M208 an exceptional product. Many hidden solution details, such as the motion detector that switches the M208 on automatically when it is picked up and moved, make using it a joy.

## **Chapter structure**

The M208 Operation manual is designed in a modular way in the same as the M51. New functions can be added to the M208 through the software update option.

The new functions are described in the following chapters, which are delivered to accompany each relevant software update from Revox. Simply replace the cover page containing the chapter overview and the relevant chapter in the manual. In this way, your manual is always up to date. You will find a version index number at the bottom righthand corner of the cover page.

## Batteries

Because the M208 uses the latest processor technology with very low current requirements, you will not have to change the batteries very often. In the following chapters, you will find out how your settings affect the current consumption and therefore the working life of the batteries.

Open the battery compartment cover on the underside of the remote control, to insert new batteries. Insert the four batteries as shown on the bottom of the battery compartment.

You should only use **Alkaline LR 03/AAA** batteries, also known as **Micro** and they must be inserted with correct polarity.

Revox does not recommend the use of rechargeable batteries. Because of the low voltage of 1.2V as compared to 1.5V, as well as the high levels of self-discharge by rechargeables (particularly with NIMH models), the battery warning display appears frequently and without justification.

## Advice on the disposal of batteries

Used batteries should be disposed of at recognised battery collection points or through the shop where you bought them.

## Care

The remote control should be cleaned using just a damp, soft and clean cloth without any cleaning agents.

If any liquid should get into the remote control, the unit should be returned to Revox. The Revox Service Department cleans the M208 and if necessary, will replace the keypad mat. Never open the remote control yourself as you could damage sensitive components through a discharge of static electricity and nullify any guarantee rights.

# Remote control

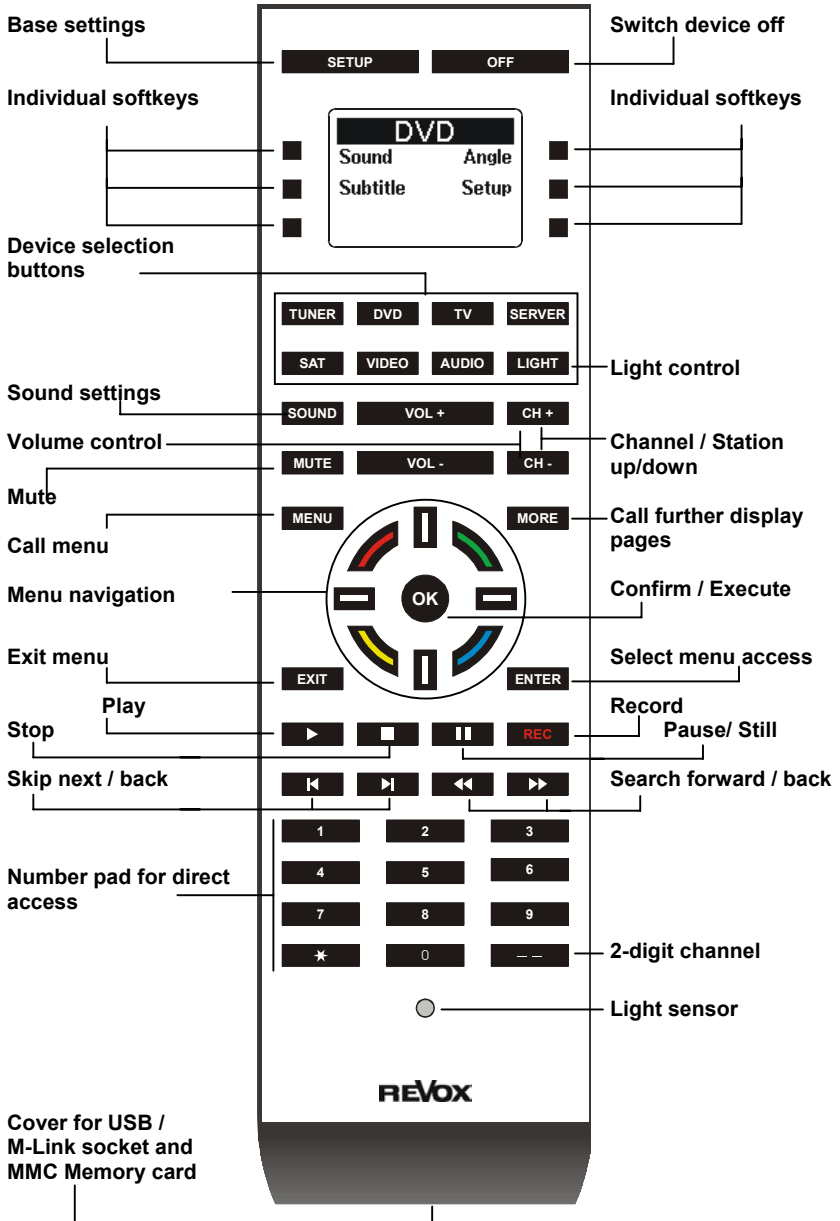

## MMC card

There is a hinged cover on the lower front end of the M208. Opening this cover gives you access to the MMC memory card and the link connection.

### MMC memory card

All device data is stored on the MMC card by the M208. For this reason, the M208 only operates when the MMC card is inserted. If there is no MMC card in the M208 or if the card is incorrectly inserted, the following message appears on the display:



Check the MMC card. If the message continues to appear even through the MMC card is correctly inserted and locked in position, it is possible that the software is not installed or is incorrectly installed on the card. In this case, you should carry out an update with the M208 Manager PC program.



#### MMC Multi Media Card

The MMC card has a Revox file system and cannot be read by the Windows® operating system.

## Advice on MMC card

You should use exclusively MMC cards from Revox. There is no guarantee that the unit will function correctly if you use cards from other manufacturers. Use of such cards also nullifies your guarantee rights.

### Inserting the MMC card

Insert the MMC card into the card compartment as shown below. The gold contacts should be at the top with the angled corner to the left.

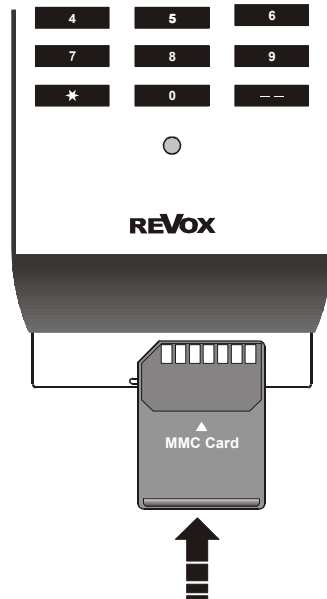

Press the card gently into the compartment to release it, if you want to remove it. The compartment has an eject mechanism that then pushes the card out.

## M208 Link

The unit can exchange data with different devices using the M208 Link.

Access to the M208 Link is underneath the hinged cover on the lower front end of the M208, in the form of a USB mini socket.

The required USB cable is supplied with the M208.

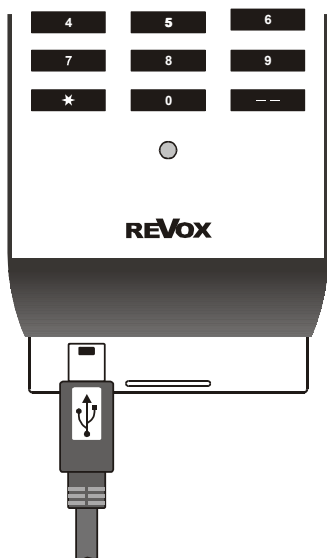

The M208 Link fulfils the following functions:

### Synchronisation with the M51

M51 Tuner stations, as well as Revox server data are accepted by the M208 and stored on the MMC card. You will find further information about the synchronisation process and/or the connection diagram in the following chapter, *Synchronisation* and in the description of the corresponding devices.

### Configuring the M208

New device controls can be added to the M208 and/ or existing configurations can be modified with the M208 Manager PC program. You will find the M208 Manager on the Revox homepage [www.revox.de](http://www.revox.de)

### Firmware update

As well as loading software for device control using the M208 Link, you can also load new firmware for the integrated microprocessor. This is also done through the M208 Manager.

## Synchronisation

The M208 Remote control offers the option of data exchange with the M51. Here, all relevant information is transferred to the remote control, e.g. the M51 Tuner stations or from the Revox music server.

Connect the M208 with the supplied USB cable to the M208 Link interface, as shown in the figure on the right. The Link interface for its part is connected to the M51 through a cable to the M Link. Once the connection is established, select the source that is to be synchronised at the M208 and press the SETUP button.

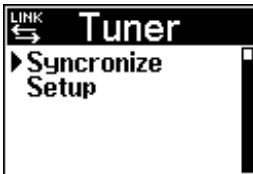

Switch on the M51 and confirm the **► Synchronize** setting with the **OK** button. Data exchange now starts and you are kept informed of the progress.

- \* Only possible in connection with the Re:source SAT Module from Revox and the 5000 PVR Series Topfield receivers with hard disk (HDD).

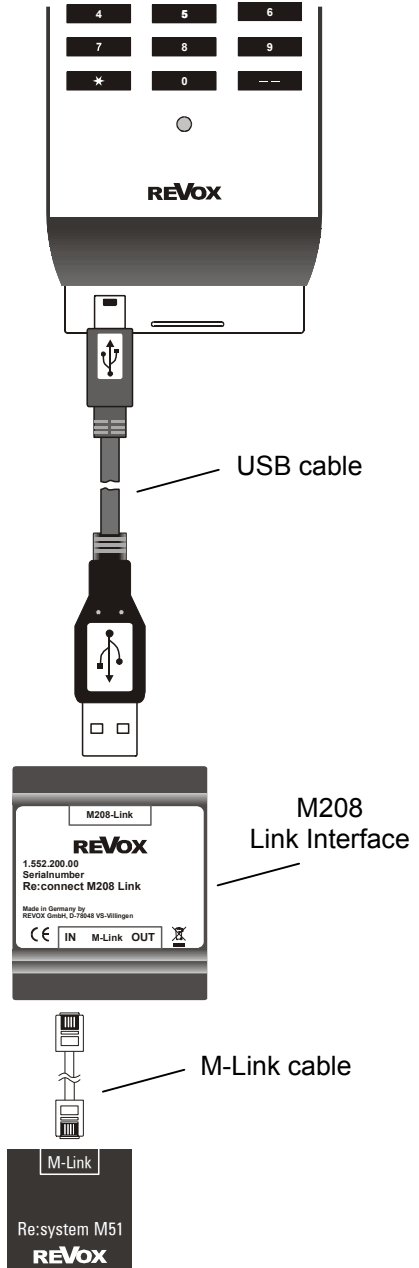



## Operation

### Basic settings

The Setup menu where you can make the basic settings appears automatically after you insert the batteries. In normal operation, you get to the Setup Menu with the **Setup** button.



The most important settings are made in this menu. Each setting is saved without needing to confirm it, until such time as you make a modification. All settings in the Setup Menu are made using the Navigation Compass.

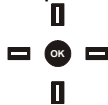

Using the vertical pair of buttons (North/South) you select the menu. With the horizontal buttons (West/East) and the OK button, you change the corresponding menu setting. The small arrowhead on lefthand side of the display, indicates the current menu. Additionally, the position bar on the righthand side of the display gives you information about the location within the Setup Menu.

### Contrast [Contrast]



The display contrast is already at the optimum setting when the unit leaves the factory. However, depending on the read angle, a different contrast value can give you a better result. The contrast value range goes from 1 (weak contrast) to 24 (strong contrast).

### Background lighting [Backlight]



The brightness of the blue backlighting can be set in three levels from **Low** (dark), through **Medium** to **High** (bright). The backlighting is switched off completely with the **Off** option.



The brighter the backlighting, the shorter the working life of the batteries.

## Automatic switch-off [Timeout]



The M208 has an automatic switch-off feature that extends the working life of the batteries. The M208 is switched on using an integrated movement sensor, which recognises each movement of the remote control and returns it to the operating mode that was active before the automatic switch-off. In a very quiet room, the mechanics of the sensor are audible, but this does not indicate a fault.

Through the **Timeout** Menu, you define the length of time from the last time a button was pressed or the last time the unit was moved, until the automatic switch-off. This timeout can be set to one of three values, **3, 6 or 10 seconds**.



The Timeout Menu does not define the timeout for the backlighting. This is fixed and cannot be changed.

## Ambient light [Amb. Light]



The brightness sensor is located at the lower end of the remote control, below the 0 button.

Using the **Amb. Light** function, you can define at which ambient brightness level the blue backlighting should be switched on. As well as the three brightness levels, the sensor can be deactivated through the **Off** setting. With the **Off** setting, the backlighting is switched on each time a button is pressed whatever the level of ambient brightness.

**OFF:** deactivated  
**Low:** dark  
**Medium:** semi-dark  
**High:** bright



The brighter the ambient brightness setting, the shorter the working life of the batteries. The setting **Off** results in the shortest working life.

### Font size [Font Size]



The M208 gives you the option to modify the font size for the TUNER and the SERVER.

The two displays below show the SERVER Menu in small and large font sizes.:

Setting: **Small**



Setting: **Large**



The font size setting has no effect on any other devices. They are displayed in a small font size.

### Scrolling [Scrolling]



The Scrolling function is activated automatically by the M208 in the case of texts that exceed a certain length and therefore cannot be displayed completely. In this case, the texts are shown in sections, starting from the beginning of the text element.

Using the Scrolling function, you can define the speed at which such texts are scrolled. The two options are **slow** and **fast**.

## Infrared power [IR-Power]



The M208 can send the IR commands with two different power levels. This offers you particular advantages if you frequently want to control devices over longer distances or if you have a device that doesn't react very sensitively to IR commands.

If you select the **Low IR Power** setting, the MR208 sends at low power level. At the **High** setting, a higher power level is used.



The High setting causes a greater drain on the batteries and therefore reduces the working life.

## Information [Information]



Using the Information menu-point, you can display the current version number of the M208.



Additionally, this menu also displays the brightness values as calculated by the brightness sensor in the lower part of the remote control. This value can be between 0 and 255. 0 indicates complete darkness; 255 is the brightest value.

## Battery display



The battery state display appears in the top left display field, to indicate that the batteries are getting weak. You can continue to use the remote control but you should replace the batteries with new ones at the next opportunity.

You should only use **Alkaline LR 03/AAA** batteries, also known as **Micro** and they must be inserted with correct polarity.

### ①

Revox does not recommend the use of rechargeable batteries. Because of the low voltage of 1.2V as compared to 1.5V, as well as the high levels of self-discharge by rechargeables (particularly with NIMH models), the battery warning display appears frequently and without justification.

## Status display

### IR send

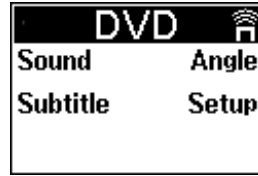

The IR symbol appears in the upper display fields each time the M208 sends an infrared command.

### Link



If you connect the M208 to the M51 using the M208 Link interface to synchronise the Server database for example, the Link symbol appears.

### USB



The USB symbol appears as soon as the M208 is connected with a PC USB port over a USB cable. This connection is only needed for data transfer with the M208 Manager PC program.



## B TUNER

### Synchronising tuner stations

The following display appears the first time the Tuner is started on the remote control:



This indicates that the Tuner stations are not yet synchronised. It is possible to operate the remote control using the CH +/- and/or the numeric keypad. Tuner operation is however much more comfortable if the M51 Tuner stations have been synchronised with the M208.

To do this, you should connect the M208 to the M208 Link interface with the USB cable supplied. The Link interface for its part is connected to the M51 through a cable to the M Link.

⇒ **see Synchronisation plan in Chapter A-8.**

Once the connection is established, switch on the M51 and select the **TUNER** at the M208 and press the **SETUP** button. Confirm the **► Synchronize** setting with the **OK** button.

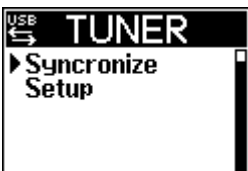

### Important advice

Neither the M51 nor the M208 can be operated while the synchronisation is running.

Synchronisation now starts and takes a few seconds. When the synchronisation is complete, the following display appears:

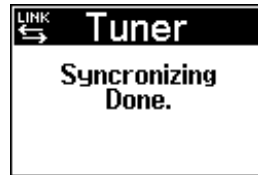

The next time you call the **Tuner**, all tuner stations stored in the M51 appear on the display. The display order is determined by the order they were stored in the M51.



### ①

If you modify the tuner stations in the **M51** by adding, deleting, renaming or moving entries, you should carry out another synchronisation with the M208. Otherwise, you will call wrong tuner stations.

# Operation

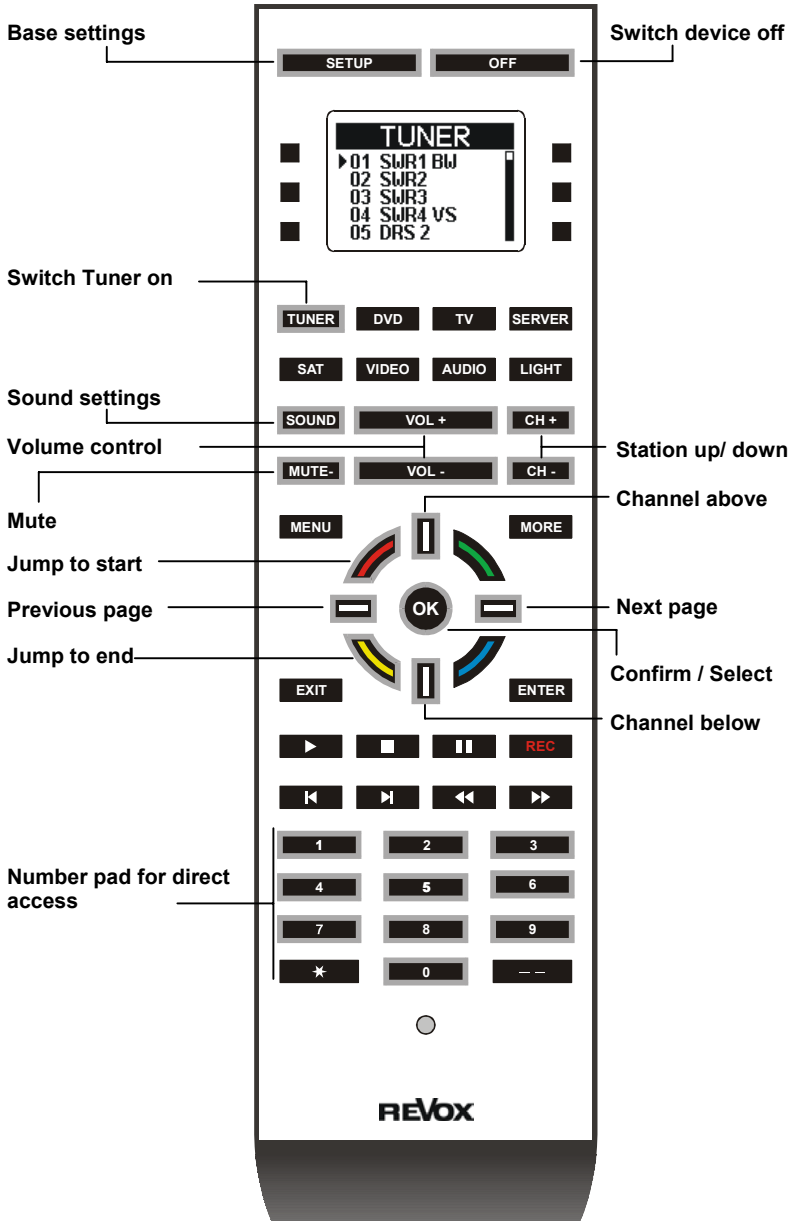



## Operation

Operation of the Tuner is very simple. You switch on the Tuner at the M51 or in another room, if you have installed the Revox Multiroom System, using the **TUNER** button. The last selected station is automatically selected. You can scroll up and down the list of stations with the **CH+** and **CH-** buttons or you can enter the station memory number directly through the numeric keypad. The M208 display is not updated. It continues to show the station that was selected last through the navigations compass.

Working with the navigation compass gives the highest levels of user comfort. You simply select the desired station using the navigation compass and confirm your choice with the **OK** button. There are several navigation options to help you find the desired station in the shortest time:

### Single jump

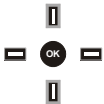

Using the vertical (North/South) buttons, you can select the station above or below your current position in the list.

### Page jump

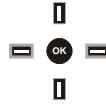

With the two horizontal (West/East) buttons, you can jump to the next or previous page within the station list.

If you have selected the small font size, a positional jump covers 5 stations. If you have selected the large font size, the jump only covers 3 stations.

### Start / End jump



Using the red button you can jump to the first station in the list, Station 1. The yellow button takes you to the last station in the list.

You confirm your station selection with the **OK** button. The M51 and the wall display in the Additional rooms of a Multiroom System, now also show the station that you have selected with your remote control.



# C DVD

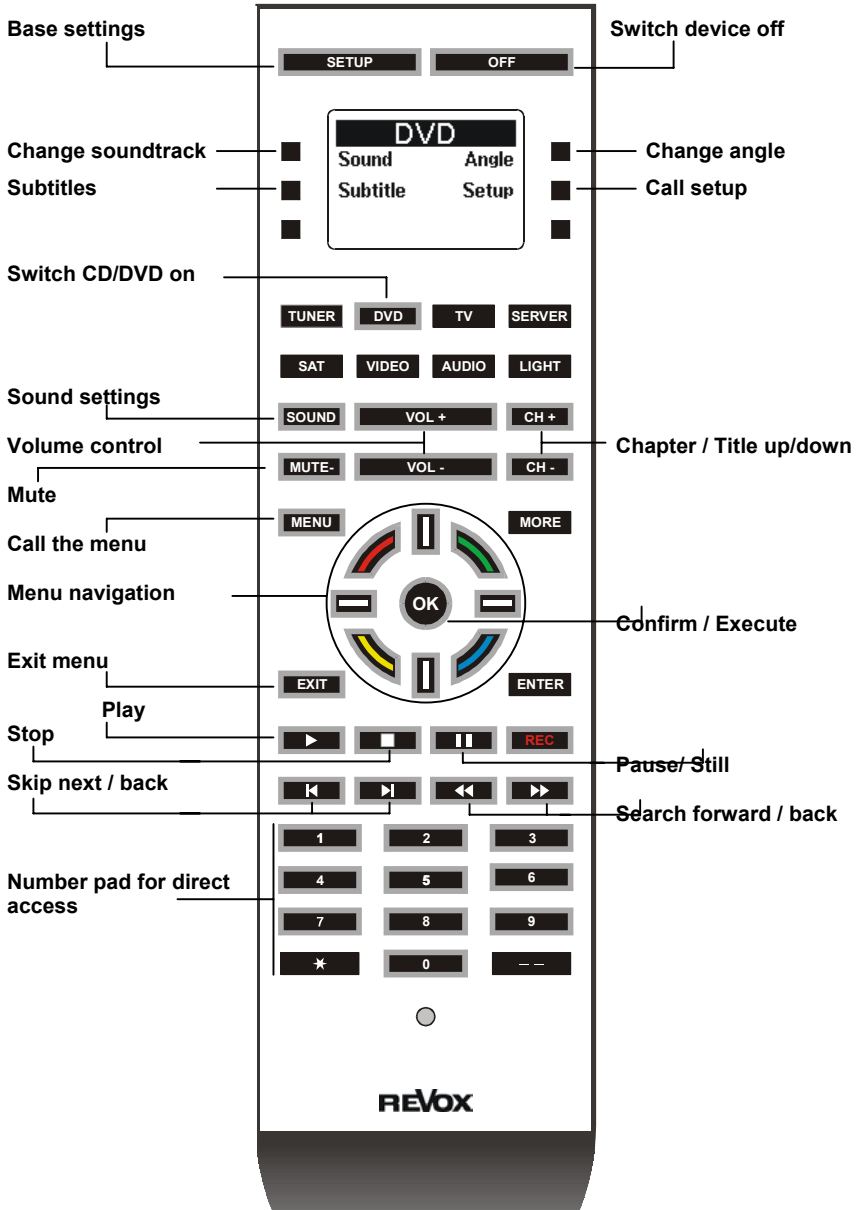



Re:source M51 DVD

**Page 1**

Change soundtrack ▾	<b>DVD</b>	↵ Change viewing angle
Select/ modify subtitles →	<b>Sound      Angle</b>	← Call DVD Setup Menu
	<b>Subtitle    Setup</b>	

# D TV

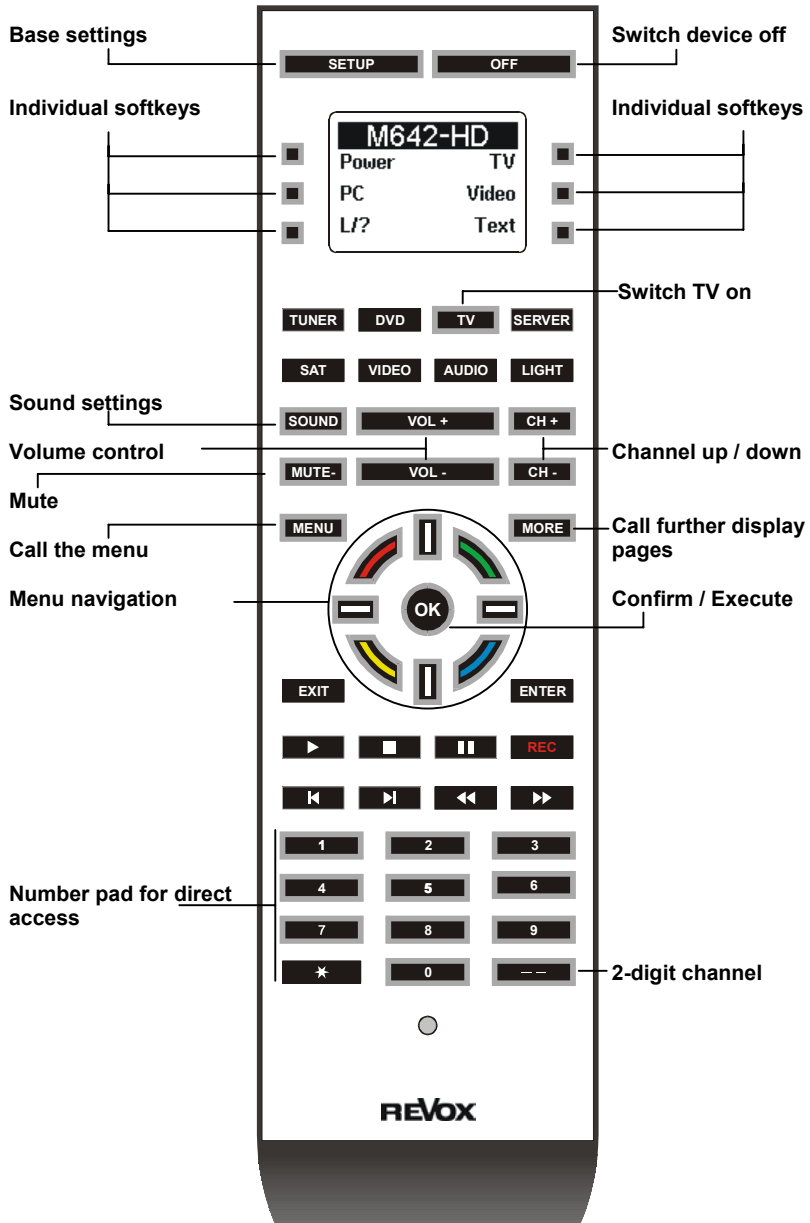



Re:ception plasma 42 HD

Page 1

Switch off Plasma ↘

Select PC/DVI input →

Videotext on/off ↗

42HD	
OFF	TV-ON
PC/DVI	Video
V-Text	Format

↓ MORE ↓

↙ Switch on with TV

← Select video source

↖ Select format

Page 2

Function button 1 ↘

Function button 3 →

Programme list/ Videotext ↗

42HD	
F1	F2
F3	F4
L/?	M/S

↓ MORE ↓

↙ Function button 2

← Function button 4

↖ Change soundtrack

Page 3

Freeze frame ↘

Auto zoom →

Time ↗

42HD	
Freeze	PIP
Auto	Info
Mix	

↓ MORE ↓

↙ Picture-In-Picture function

← Channel information

## E SERVER

Operation through the M51

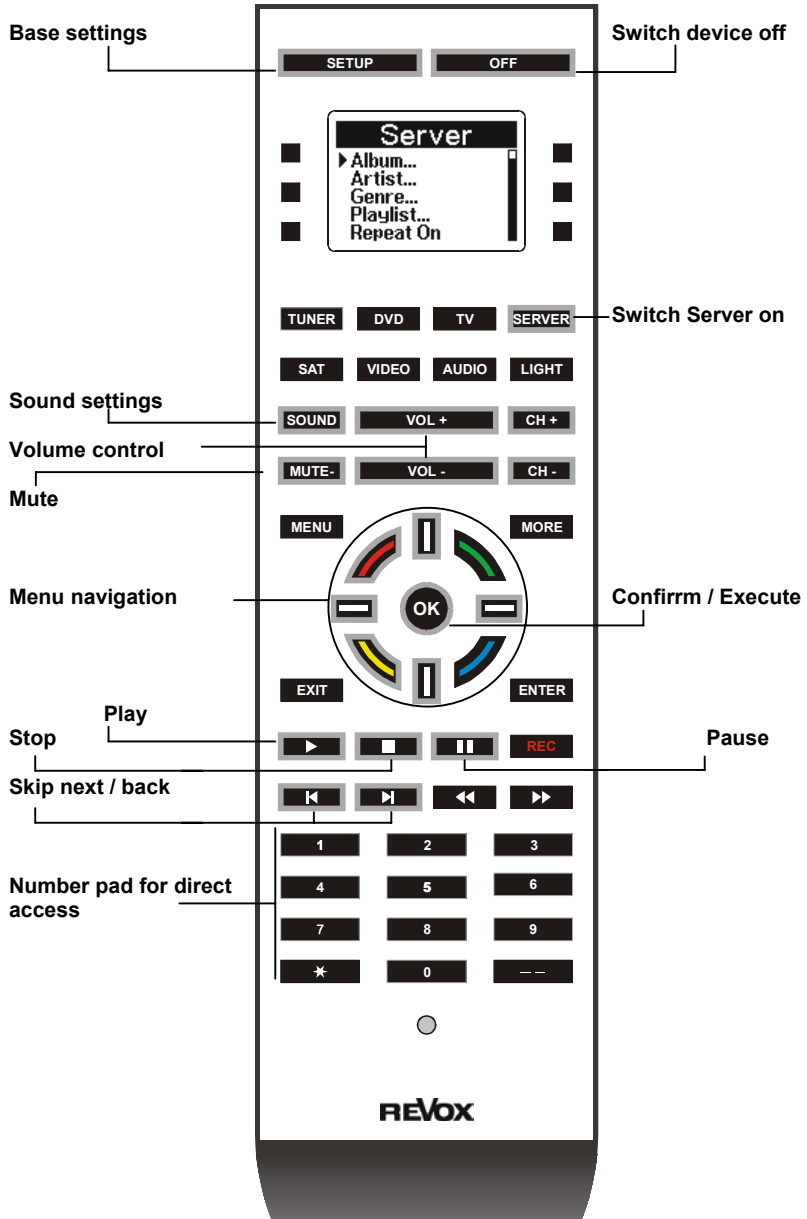

## Server

### Synchronising the Revox Server

The M208 can store all the relevant data, such as the name of the album or the artist from the music server, which gives you the option to operate your music server from every room in your house or apartment. An IR receiver, such as the Re:connect M204 is enough for this.

A synchronisation is carried out in order to execute a data exchange between the music server and the M208. To do this, you should connect the M208 to the M208 Link interface with the USB cable supplied. The Link interface for its part is connected to the M51 through a cable to the M Link. See Chapter A-8, *Synchronisation*.

Once the connection is established, select **SERVER** at the M208 and press the **SETUP** button. Confirm the **► Synchronize** setting with the **OK** button.



### Important advice

Neither the M51 nor the M208 can be operated while the synchronisation is running.

Data exchange now starts and depending on the number of albums stored, can last anything from a few seconds to 10 minutes. During this process, all album, artist, genre and playlist data is transferred in sequence. The progress of each sequential transfer is shown on the M208 as a percentage value:



When the synchronisation is complete, the following display appears:



① You should carry out a synchronisation whenever you have added a new album to the server or if you have edited a name.



## Operation

Using the M208, you can operate your music server in the same way that you are used to do with the M51, or with the Revox Multiroom System wall display.

Four options are available to you as selection criteria:

**Album...**

**Artist...**

**Genre...**

**Playlist...**

### Album...

Select the **Album...** option with the navigation compass and confirm your selection with the **OK** button.



All albums on the music server are now listed in alphabetical order.



You can now use the vertical navigation buttons to select the desired album and confirm your choice with **OK**.

An IR command is sent as soon as you confirm your selection. The remote control must be directed at the IR receiver during this time.

If you have stored a large number of albums, searching for a particular album can be made significantly easier using the innovative navigation compass. The following options are on offer:

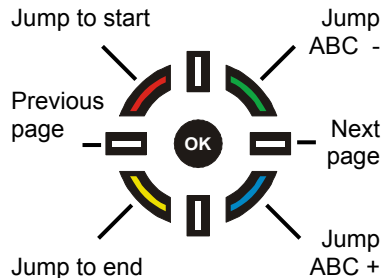

### Artist...

Select the **Artist...** option with the navigation compass and confirm your selection with the **OK** button.



All artists, groups, solo singers, etc. on the music server are now listed in alphabetical order.



You can now use the vertical navigation buttons to select the desired artist and confirm your selection with the **OK** button.

An infrared command is sent as soon as you confirm your selection. The remote control must be directed at the IR receiver during this time.

If you have stored a large number of artists, searching can be made significantly easier using the navigation compass. The following options are on offer:

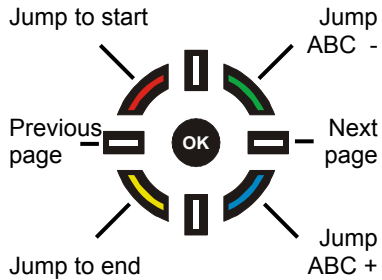

## Genre...

Select the **Genre...** option with the navigation compass and confirm your selection with the **OK** button.



All genre classifications on the music server are now listed in alphabetical order:



Select the desired Genre with the navigation compass and confirm your selection with the **OK** button. All albums on the music server that match the selected genre are now listed in alphabetical order. Selected the desired album as described above and confirm your choice with the **OK** button. If you have stored a large number of albums, searching for a particular album can be made significantly easier using the innovative navigation compass.

## Playlist...

Select the **Playlist...** option with the navigation compass and confirm your selection with the **OK** button.



A list of all the playlists you have created now appears. Select the desired playlist with the navigation compass and confirm your selection with the **OK** button.

### ①

A playlist contains tracks or complete albums that have been put together by the user himself. The order of the tracks is also defined by the user and is not displayed in alphabetic order, as is otherwise the case. These lists of tracks are either created at a PC using the **XIVA Producer** program or direct at the music server.

## Repeat

Using the **Repeat On/ Repeat Off** selections, you can decide whether the album you are listening to should be repeated or not. The default setting is without repetition.

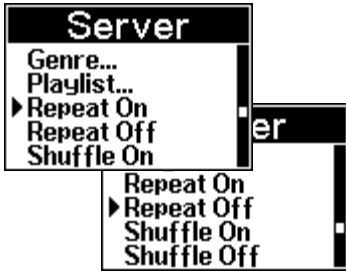

Using the remote control, you can now trigger the repetition of the album by selecting **Repeat On** and pressing **OK** or you can cancel the repetition setting through **Repeat Off**. The **Repeat Off** command also has to be confirmed with the **OK** button.

The current mode selection is shown in the **M51** display on the second page of the Server Menu.



M51 Server Menu

## Shuffle

Using the **Shuffle ON/ Shuffle Off** selection, you can select whether the tracks on an album will be played in a random or in the defined order. The default setting is that the tracks are played in the defined order.

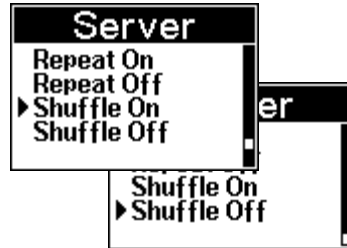

Select **Shuffle On** and confirm this with the **OK** button for a random play order.

To end the random play order, select **Shuffle Off** and confirm this with the **OK** button as well.

The current mode selection is shown in the **M51** display on the second page of the Server Menu.



M51 Server Menu

# Server

## Original M37 Remote control

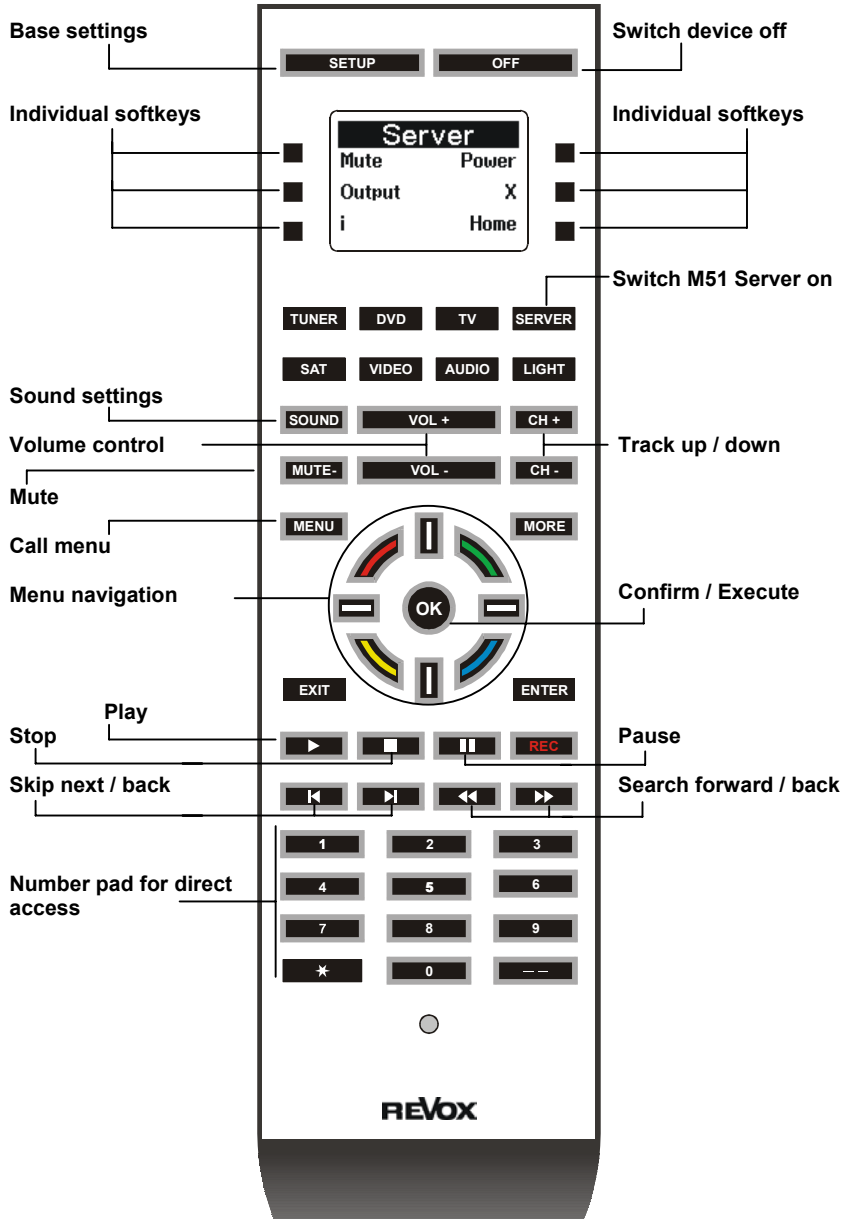

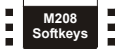

## Original M37 Remote control

## Page 1

Mute ↘	<b>M37</b>	↙ Server on/off
Select audio output →	Mute      Power	← Cancel
Information /Edit text ↗	Output      X	↖ Back to Main Menu
	i              Home	
	↓ <b>MORE</b> ↓	

## Page 2

Select album ↘	<b>M37</b>	↙ Select artist
Select genre →	Album      Artist	← Select playlist
Once only repeat ↗	Genre      Playlist	↖ Permanent repeat
	once Repeat    oo	
	↓ <b>MORE</b> ↓	

①

Playlist: A compilation of different albums and artists

# F SAT

## Operation through the M51

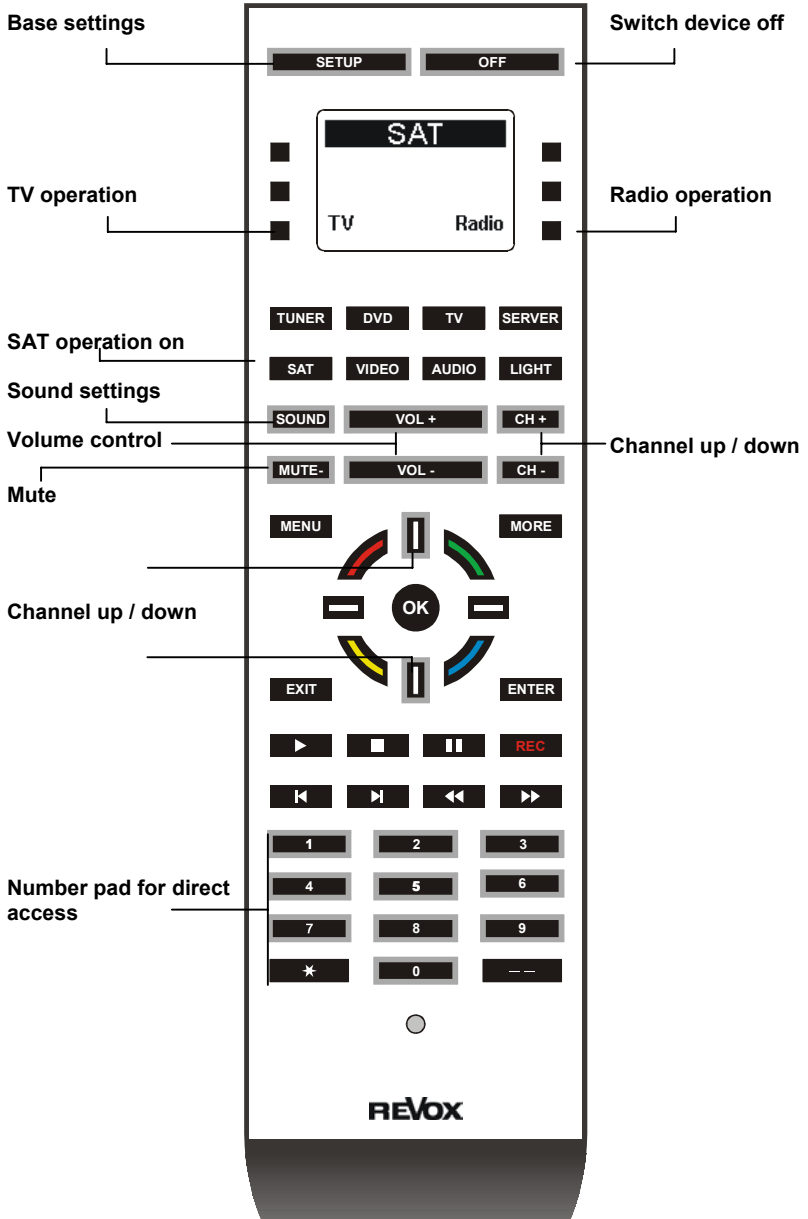





## SAT

### Original Topfield Remote control

Type : 5000-PVR series

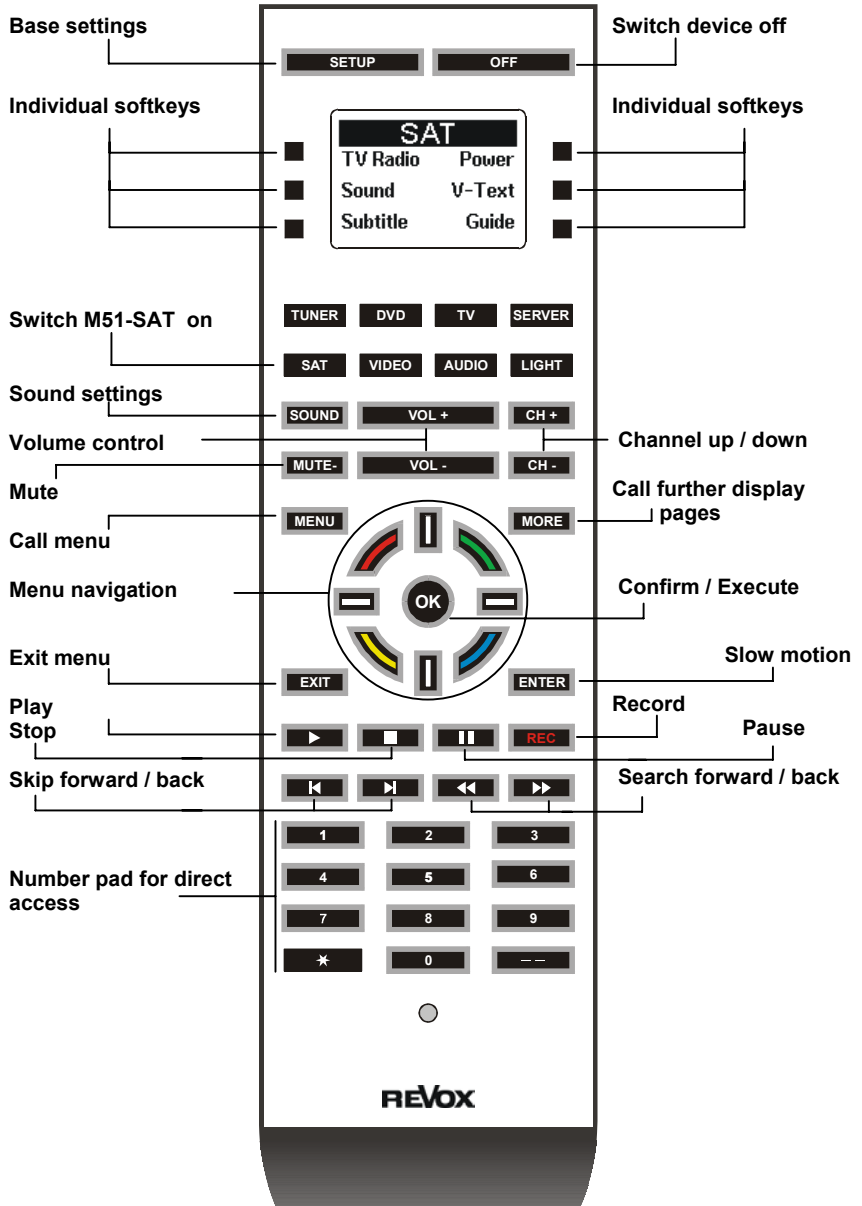



## Topfield 5000-PVR Series

## Page 1

Switch between TV / Radio ↘	<b>SAT</b> TV Radio    Power Sound       V-Text Subtitle    Guide ↓ MORE ↓	↙ Switch on receiver
Sound operating mode →		← Select videotext
Subtitles ↗		↖ EPG

## Page 2

Show favourites list ↘	<b>SAT</b> Favourite    Live Archive       Sleep Info           Select ↓ MORE ↓	↙ Live transmission
Show film archive →		← Sleep function
Programme information ↗		↖ e.g. Menu selection

## Page 3

UHF Modulator setting ↘	<b>SAT</b> UHF            SAT > <	↙ SAT List / Sub-main picture
List for PIP sub-picture →		
	↓ MORE ↓	

①

EPG: Electronic Programme Guide – Online programm listings  
 PIP: Picture-in-picture function

## G VIDEO

You can access the selection menu that offers you 4 video sources through the **VIDEO** button.

You can select one of the M51 sources through the softkeys and following that, you can use the button with the grey border. In this way, all commands are sent to the source address.

Example:

Selected source: **Video 1**

All commands, such as **Play** or **OK** will be sent to the source address **Video 1**.



When selecting the source, you should be aware that the address that is selected, is the one that was assigned to the corresponding source button through the **M51 Remote Menu**.

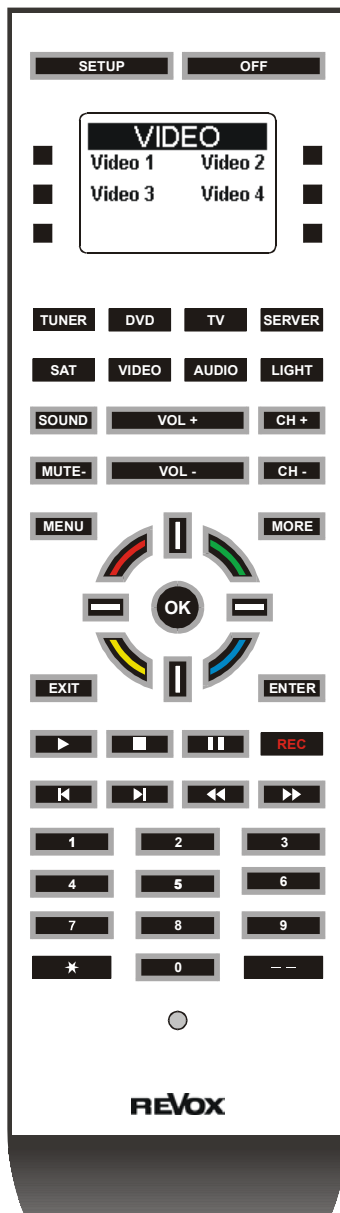



## H AUDIO

You can access the selection menu that offers you 6 audio sources through the **AUDIO** button.

You can select one of the M51 sources through the softkeys and following that, you can use the button with the grey border. In this way, all commands are sent to the source address.

Example:

Selected source: **Aux 1**

All commands, such as **Play** or **OK** will be sent to the source address **Aux 1**.



When selecting the source, you should be aware that the address that is selected, is the one that was assigned to the corresponding source button through the **M51 Remote Menu**.

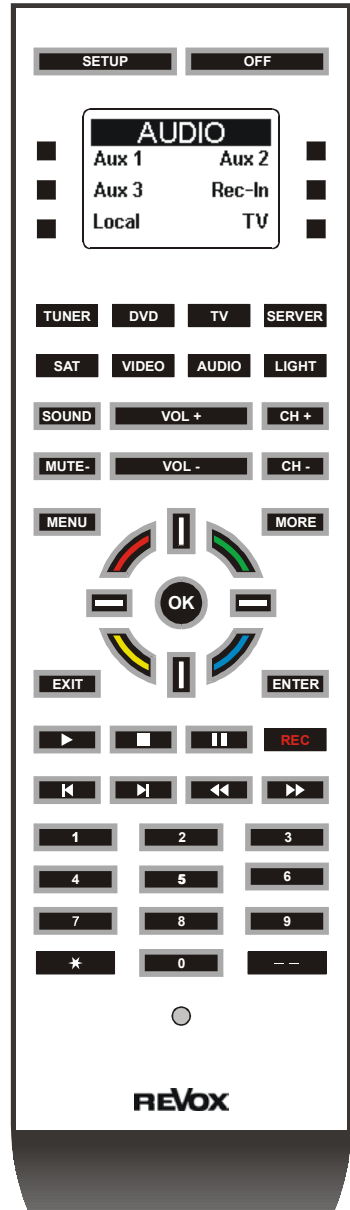



# AUDIO

## Page 1

Analogue source Aux 1 ↘	<b>AUDIO</b> Aux 1      Aux 2 Aux 3      Rec-In Local      TV ↓ MORE ↓	↙ Analogue source Aux 2
Analogue source Aux 3 →		← Analogue source Rec-In
Local source - MR ↗		↖ Analogue source TV

# I LIGHT





## J Sound

Using the **SOUND** button, you can make the sound settings for the M51 as well as for the Multiroom amplifier.

The buttons with the grey border are active while defining the sound settings through the softkeys. All other buttons have no functions. You will find an overview of the softkeys on the next page.

### Note:

The M51 softkeys (Page 1 of the softkeys) and those of the Multiroom amplifier (Page 2 of the softkeys) send the same infrared codes and can have an influence on each other.



MR: Multiroom

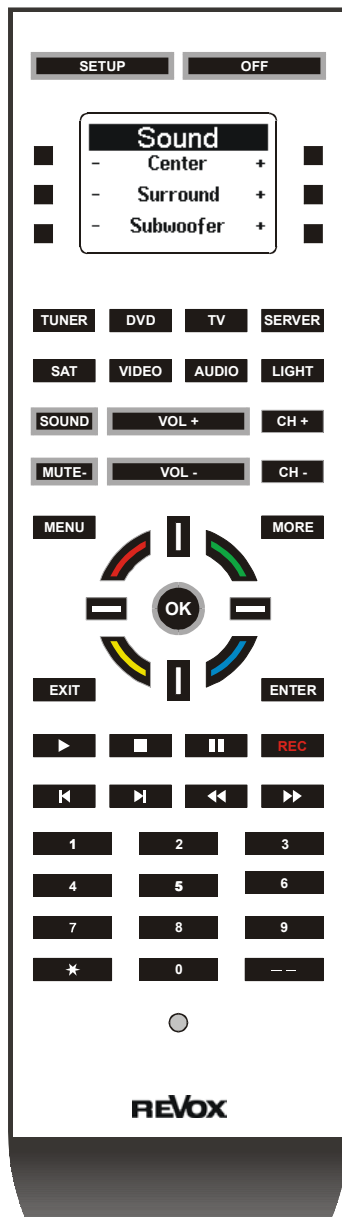

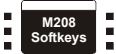

# Sound

## M51 Sound settings

### Page 1

Center Speaker volume ↘

Rear Speaker volume →

Subwoofer volume ↗

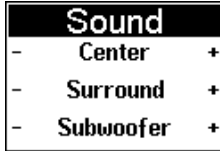

↓ MORE ↓

↙ Center Speaker volume

← Rear Speaker volume

↖ Subwoofer volume

## Multiroom amplifier sound settings

### Page 2

MR amplifier "Balance" ↘

MR amplifier "Treble" →

MR amplifier "Bass" ↗



↓ MORE ↓

↙ MR amplifier "Balance"

← MR amplifier "Treble"

↖ MR amplifier "Bass"

## M51 + MR amplifier sound settings

### Page 3

Toggle M51 room sound ↗ mode

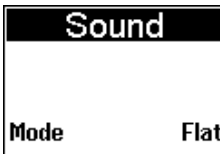

↓ MORE ↓

↖ Restore MR amplifier base settings

①  
MR: Multiroom

## K Appendix

### Troubleshooting

Problem	Possible remedy
No LCD display when unit is touched	<ul style="list-style-type: none"> <li>▪ Check the batteries and replace if necessary</li> <li>▪ Check that the batteries are in the right way round</li> <li>▪ Activate the movement sensor through the Setup Menu</li> </ul>
Backlighting remains dark	<ul style="list-style-type: none"> <li>▪ Activate backlighting in the Setup Menu → <b>Backlight</b></li> <li>▪ Is the brightness sensor covered?</li> <li>▪ Is the ambient light too bright? → Setup <b>Amb. Light</b></li> </ul>
Display shows <b>Card?</b> when a button is pressed	<ul style="list-style-type: none"> <li>▪ MMC memory card is not installed correctly or it is missing. See Chapter <b>MMC Card</b>. You are not using an original MMC card from Revox.</li> </ul>
Synchronisation with the M51 cannot be carried out	<ul style="list-style-type: none"> <li>▪ The connection through the M208 Link interface is faulty. See Chapter <b>Synchronisation</b>.</li> <li>▪ The M51 does not have the software that is needed to carry out a synchronisation. See <b>Technical Data</b>.</li> </ul>
A mechanical noise can be heard from the M208	<ul style="list-style-type: none"> <li>▪ There are two gold bearings in the M208's movement sensor that move against each other. This can be heard in a very quiet environment and does not signify a fault.</li> </ul>
The device to be controlled does not respond to the infrared command	<ul style="list-style-type: none"> <li>▪ With some M208 sources, not all buttons send infrared codes. Please check in the Operating manual of the corresponding device(s) to see whether the buttons send infrared codes (grey border). Additionally, the display shows the symbol  top right, if an infrared code is being sent.</li> <li>▪ The device cannot receive the infrared code because it is too far away or because the transfer angle is too large. Try again while standing nearer to the device and/ or hold the remote control directly in front of the device.</li> </ul>

## Technical Data

<b>Power supply:</b>	4 Alkaline batteries		
<b>Battery type:</b>	AAA / MICRO/ LR03 1.5 V – non-rechargeable		
<b>Weight:</b>	260 g (including batteries)		
<b>Dimensions:</b>	62 x 217 x 25 mm (W x H x D)		
<b>Display:</b>	80 x 120 pixel matrix LCD		
<b>LCD lighting</b>	Blue LED backlighting (adjustable)		
<b>System requirements:</b>	Tuner module software:	> Version 1.20	(FMT-1)
	Server module software:	> Version 0.81	(M57-2) MK2
		> Version 1.11	(M57-1) MK1
	Software M51 MK2	> Version 0.72	(M51+2)
	Software M51 MK1	> Version 1.10	(M51-1) Supply
	Software Display MK1	> Version 1.20	(DPL-1)

## Disposal of your old device



Your product has been manufactured from high-quality materials and components that can be recycled. If this symbol of a crossed-out, wheeled rubbish container is on the product, this means that it is covered by the EU Directive 2002/96/EG.

Please find the location of your nearest recycling point for electrical and electronic devices. Please follow local regulations and do not dispose of the device with your domestic refuse. The correct disposal of your old device helps to avoid negative impacts on the environment and on personal health.

## Guarantee

The guarantee period is 24 months. Your dealer should be your first contact if you need service. If he can't give you the help you need, send the remote control carriage free and without any accessories to your national Sales Office.

Please supply a complete description of the fault together with your address.

## Scope of delivery

- M208 Remote control
- M208 Link Interface (only M series)
- USB cable
- M Link cable (only M series)
- 4 x AAA Batteries
- Operating manual

## Free Manuals Download Website

<http://myh66.com>

<http://usermanuals.us>

<http://www.somanuals.com>

<http://www.4manuals.cc>

<http://www.manual-lib.com>

<http://www.404manual.com>

<http://www.luxmanual.com>

<http://aubethermostatmanual.com>

Golf course search by state

<http://golfingnear.com>

Email search by domain

<http://emailbydomain.com>

Auto manuals search

<http://auto.somanuals.com>

TV manuals search

<http://tv.somanuals.com>