

# Tankless Water Heater

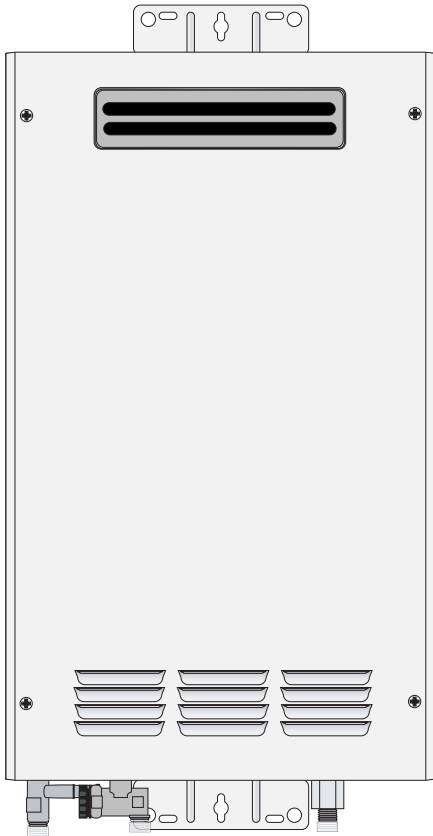

**▲ Warning: This water heater is not suitable for use in manufactured (mobile) homes!**

The purpose of this manual is twofold: one, to provide the installer with the basic directions and recommendations for the proper installation and adjustment of the water heater; and two, to the owner-operator, to explain the features, operation, safety precautions, maintenance and troubleshooting of the water heater. This manual also includes a parts list.

It is imperative that all persons who are expected to install, operate or adjust this water heater read the instructions carefully so they may understand how to perform these operations. If you don't understand these instructions or any terms within it, seek professional advice.

Any questions regarding the operation, maintenance, service or warranty of this water heater should be directed to the seller from whom it was purchased. If additional information is required, refer to the section on If You Need Service.

Do not destroy this manual. Please read carefully and keep in a safe place for future reference.



Recognize this symbol as an indication of Important Safety Information!



California Proposition 65 Warning: This product contains chemicals known to the State of California to cause cancer, birth defects or other reproductive harm.



**WARNING: If the information in these instructions is not followed exactly, a fire or explosion may result causing property damage, personal injury or death.**

## ▲ FOR YOUR SAFETY!

- Do not store or use gasoline or other flammable vapors or liquids or other combustible materials in the vicinity of this or any other appliance. To do so may result in an explosion or fire.
- WHAT TO DO IF YOU SMELL GAS
  - Do not try to light any appliance.
  - Do not touch any electrical switch; do not use any phone in your building.
  - Immediately call your gas supplier from a neighbor's phone. Follow the gas supplier's instructions.
- If you cannot reach your gas supplier, call the fire department.
- Do not return to your home until authorized by the gas supplier or fire department.
- Improper installation, adjustment, alteration, service or maintenance can cause property damage, personal injury, or death. Refer to this manual. Installation and service must be performed by a qualified installer, service agency or the gas supplier.



31-51482

## Safety Information

Safety Precautions . . . . . 3-6  
LP Gas Models . . . . . 5

## Installation Instructions

Location . . . . . 7  
Water Connections . . . . . 9-10  
Gas Supply . . . . . 11  
High Altitude . . . . . 11  
Venting . . . . . 12  
Remote Control . . . . . 13-14  
Electrical Connection . . . . . 15  
Typical Installation . . . . . 16  
Pipe Insulation . . . . . 17  
Installation Checklist . . . . . 18

## Operating Instructions

Lighting Instructions . . . . . 19  
Water Temperature . . . . . 20, 21

## Care and Cleaning

Maintenance . . . . . 22  
Housekeeping . . . . . 22, 23  
Vent Inspection . . . . . 23  
Burner Inspection . . . . . 23  
Extended Shut-Down . . . . . 23  
Draining . . . . . 24

## Troubleshooting Tips

Before You Call  
For Service . . . . . 25,26

## Customer Service

Parts List . . . . . 27  
If You Need Service . . . . . 28



## FOR YOUR RECORDS

Write the model and serial numbers here:

# \_\_\_\_\_

# \_\_\_\_\_

**You can find them on a label on the appliance.**

Staple sales slip or cancelled check here.

**Proof of the original purchase date is needed to obtain service under the warranty.**



## READ THIS MANUAL

**Inside you will find many helpful hints on how to use and maintain your water heater properly. A little preventive care on your part can save you time and money over the life of your water heater.**

**You'll find many answers to common problems in the Troubleshooting Guide. If you review the chart of Troubleshooting Tips first, you may not need to call for service.**



## READ THE SAFETY INFORMATION

**Your safety and the safety of others are very important. There are many important safety messages in this manual and on your appliance. Always read and obey all safety messages.**



**This is the safety alert symbol. Recognize this symbol as an indication of Important Safety Information! This symbol alerts you to potential hazards that can kill or hurt you and others.**

**All safety messages will follow the safety alert symbol and either the word "DANGER", "WARNING", "CAUTION" or "NOTICE".**

These words mean:



**DANGER**

**An imminently hazardous situation that will result in death or serious injury.**



**WARNING**

**A potentially hazardous situation that could result in death or serious injury and/or damage to property.**



**CAUTION**

**A potentially hazardous situation that may result in minor or moderate injury.**

**Notice:**

**Attention is called to observe a specified procedure or maintain a specific condition.**

# IMPORTANT SAFETY INFORMATION. READ ALL INSTRUCTIONS BEFORE USING.

Be sure to read and understand the entire Use and Care Manual before attempting to install or operate this water heater. It may save you time and money. Pay particular attention to the Safety Instructions. Failure to follow these warnings could result in serious bodily injury or death. Should you have problems understanding the instructions in this manual, or have any questions, STOP, and get help from a qualified service technician, or the local gas utility.

## ⚠ DANGER!



### PROPERLY INSTALL WATER HEATER...

Failure to properly install the water heater outdoors as outlined in the Installation Instructions in this manual can result in unsafe operation of the water heater. To avoid the risk of fire, explosion, or asphyxiation from carbon monoxide, never operate this water heater unless it is installed properly and has an adequate air supply for proper operation. Be sure to inspect the flue terminal for proper installation at initial start-up; and at least annually thereafter. Refer to the Care and Cleaning section of this manual for more information regarding flue terminal inspection.

## ⚠ WARNING!

Gasoline, as well as other flammable materials and liquids (adhesives, solvents, paint thinners etc.), and the vapors they produce are extremely dangerous. DO NOT handle, use or store gasoline or other flammable or combustible materials anywhere near or in the vicinity of a water heater or any other appliance. Be sure to read and follow the labels on the water heater, as well as the warnings printed in this manual. Failure to do so can result in property damage, bodily injury or death.

**⚠ DANGER**



<p><b>⚠ Vapors from flammable liquids will explode and catch fire causing death or severe burns.</b></p> <p>Do not use or store flammable products such as gasoline, solvents or adhesives in the same room or area near the water heater.</p> <p>Keep flammable products:</p> <ol style="list-style-type: none"><li>1. far away from heater,</li><li>2. in approved containers,</li><li>3. tightly closed and</li><li>4. out of children's reach.</li></ol>	<p>Water heater has a main burner flame.</p> <p>The main burner flame:</p> <ol style="list-style-type: none"><li>1. which can come on at any time and</li><li>2. will ignite flammable vapors.</li></ol> <p>Vapors:</p> <ol style="list-style-type: none"><li>1. cannot be seen,</li><li>2. are heavier than air,</li><li>3. go a long way on the floor and</li><li>4. can be carried from other rooms to the main burner flame by air currents.</li></ol>
--------------------------------------------------------------------------------------------------------------------------------------------------------------------------------------------------------------------------------------------------------------------------------------------------------------------------------------------------------------------------------------------------------------------------------------------------------------	------------------------------------------------------------------------------------------------------------------------------------------------------------------------------------------------------------------------------------------------------------------------------------------------------------------------------------------------------------------------------------------------------------------------------------------------------------

**Installation:**

Do not install water heater where flammable products will be stored or used unless the main burner flame is at least	18" above the floor. This will reduce, but not eliminate, the risk of vapors being ignited by the main burner flame.
----------------------------------------------------------------------------------------------------------------------	----------------------------------------------------------------------------------------------------------------------

Read and follow water heater warnings and instructions. If owners manual is missing, contact the retailer or manufacturer.





# **! DANGER!**

## **NATURAL GAS AND LIQUEFIED PETROLEUM MODELS**

Both LP and natural gas have an odorant added to aid in detecting a gas leak. Some people may not physically be able to smell or recognize this odorant. If you are unsure or unfamiliar with the smell of LP or natural gas, ask the gas supplier. Other conditions, such as “odorant fade”, which causes the odorant to diminish in intensity, can also hide or camouflage a gas leak.

- **Water heaters utilizing LP gas are different from natural gas models. A natural gas water heater will not function safely on LP gas and vice versa.**
- **No attempt should ever be made to convert the water heater from natural gas to LP gas. To avoid possible equipment damage, personal injury or fire, do not connect the water heater to a fuel type not in accordance with the unit data plate; propane for propane units and natural gas for natural gas units. These units are not certified for any other fuel type.**
- **LP appliances should not be installed below grade (for example, in a basement) if such installation is prohibited by federal, state and/or local laws, rules, regulations or customs.**
- **Propane or LP gas must be used with great caution. It is heavier than air and will collect first in lower areas making it hard to detect at nose level.**
- **Before attempting to light the water heater, make sure to look and smell for gas leaks. Use a soapy solution to check all gas fittings and connections. Bubbling at a connection indicates a leak that must be corrected. When smelling to detect a gas leak, be sure to sniff near the floor also.**
- **Gas detectors are recommended in LP and natural gas applications and their installation should be in accordance with the detector manufacturer’s recommendations and/or local laws, rules, regulations or customs.**
- **It is recommended that more than one method, such as soapy solution, gas detectors, etc., be used to detect leaks in gas applications.**

**Notice: If a gas leak is present or suspected:**

- **Do not attempt to find the cause yourself.**
- **Do not try to light any appliance.**
- **Do not touch any electrical switch.**
- **Do not use any phone in your building.**
- **Leave the house immediately and make sure your family and pets leave also.**
- **Leave the doors open for ventilation and contact the gas supplier, a qualified service agency or the fire department.**
- **Stay away from the house (or building) until the service call has been made, the leak is corrected and a qualified agency has determined the area to be safe.**

# IMPORTANT SAFETY INFORMATION. READ ALL INSTRUCTIONS BEFORE USING.

---

## WARNING!

For your safety, the information in this manual must be followed to minimize the risk of fire or explosion, electric shock, or to prevent property damage, personal injury, or loss of life.



## FOR INSTALLATIONS IN THE STATE OF CALIFORNIA

---

California Law requires that residential water heaters must be braced, anchored or strapped to resist falling or horizontal displacement due to earthquake motions. For residential water heaters up to 52 gallon capacity, a brochure with generic earthquake bracing instructions can be obtained from: Office of the State Architect, 400 P Street, Sacramento, CA 95814 or you may call 916-445-8100 or ask a water heater dealer.

However, applicable local codes shall govern installation. For residential water heaters of a capacity greater than 52 gallons or tankless-style, consult the local building jurisdiction code for acceptable bracing procedures.



## SAFETY PRECAUTIONS

---

Have the installer show you the location of the gas shut-off valve and how to shut it off if necessary. Turn off the manual shut-off valve if the water heater has been subjected to overheating, fire, flood, physical damage or if the gas supply fails to shut off.

- Read this manual entirely before installing or operating the water heater.
- Use this appliance only for its intended purpose as described in this Use and Care Manual.
- Be sure your appliance is properly installed in accordance with local codes and the provided installation instructions.
- Do not attempt to repair or replace any part of your water heater unless it is specifically recommended in this manual. All other servicing should be referred to a qualified technician.



READ AND FOLLOW THIS SAFETY INFORMATION CAREFULLY.

---

## SAVE THESE INSTRUCTIONS

# Installing the water heater.

This water heater must be installed in accordance with these instructions, local codes, utility company requirements, and/or in the absence of local codes, use the latest edition of the American National Standard/National Fuel Gas Code. A copy can be purchased from either the American Gas Association, 400 North Capitol Street Northwest, Washington, DC 20001 as ANSI standard Z223.1 or National Fire Protection Association, 1 Batterymarch Park, Quincy, MA 02269 as NFPA 54. In Canada, the latest edition of the CSA B149.1 Natural Gas and Propane Installation, and the Canadian Electrical Code, CSA C22.1 Part 1, in the absence of local codes.

## Location

**This water heater is for OUTDOOR installation ONLY!**

**This water heater is an outdoor model and must be mounted on a vertical wall. It must not be installed indoors or in a confined space. The water heater should be installed close to the most frequently used outlet and its position chosen with safety and service in mind.**

**Make sure people (particular children, disabled, and elderly) will not touch the hot water outlet or the flue terminal. The flue terminal and air inlet must be clear of obstruction and shrubbery.**

**The water heater should not be located in an area where leakage of the heat exchanger or connections will result in damage to the area adjacent to it or to lower floors of the structure.**

A gas fired water heater or any other appliance should not be installed in a space where liquids which give off flammable vapors are to be used or stored. Such liquids include gasoline, LP gas (butane or propane), paint or adhesives and their thinners, solvents or removers.

Because of natural air movement in a room or other enclosed space, flammable vapors can be carried some distance from where their liquids are being used or stored. The open flame of the water heater's main burner can ignite these vapors causing an explosion or fire which may result in severe burns, death or property damage.

The water heater must be located so it is not subject to physical damage, for example, by moving vehicles, area flooding, etc.

- The water heater must be installed vertically with the water, gas, and power connections on the underside, pointing toward the ground.
- Failure to properly install the water heater outdoors as outlined in this manual can result in unsafe operation.
- Hot and cold water lines should be insulated to conserve water and energy.
- The water heater and water lines should be protected from exposure to freezing temperatures.
- **Do not** install water heater where subject to vibrations.
- **Do not** install the water heater in Recreational Vehicles, Mobile Homes, Boats and other Watercrafts.
- **Do not** install the water heater near vents for heating or cooling. A minimum of 4 feet should be maintained.
- Minimum clearance from combustible construction is 1/2" sides, 0" rear (with support bracket); 12" from the bottom; 12" from the front of the water heater; and 12" from the top (24" from front and top is recommended for servicing purposes). If the clearances stated on the Instruction/Warning Label, located on the front panel of the heater differ, install the water heater according to the clearances stated on the label.

**▲ WARNING: Combustible construction refers to adjacent walls and ceilings and should not be confused with combustible or flammable products and materials. Combustible and/or flammable products and materials should never be stored in the vicinity of this or any gas appliance.**

Minimum Clearance  
from  
Combustible Construction

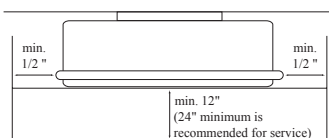

Top = 12"  
Front = 12"  
Back = 0" (with support bracket)  
Side = 1/2"  
Bottom = 12"  
min. 12"  
(24" minimum is recommended for service)

# Installing the water heater.

---

Proper operation of the water heater requires air for combustion and ventilation. Provisions for combustion and ventilation air must comply with referenced codes and standards.

## Combustion and Ventilation Air

This water heater is for **OUTDOOR** installation **ONLY**.

It must **NOT** be installed indoors or in a confined space.

---

**NOTICE:** The water heater should not be installed near an air supply containing halogenated hydrocarbons.

## Corrosive Atmospheres

The air in beauty shops, dry cleaning establishments, photo processing labs, and storage areas for liquid and powdered bleaches or swimming pool chemicals often contain such halogenated hydrocarbons.

An air supply containing halogenated hydrocarbons may be safe to breathe, but when it passes through a gas flame corrosive elements are released that will shorten the life of any gas burning appliance.

Propellants from common spray cans or gas leaks from A/C and refrigeration equipment are highly corrosive after passing through a flame.

The water heater warranty is voided when failure of the heater is due to operation in a corrosive atmosphere.

---

## Inspect Shipment

Inspect the water heater for possible damage. Check the markings on the rating plate of the water heater to be certain the type of gas supplied corresponds to the water heater requirements. Verify all included parts are present (see below).



Remote Control  
Assembly Kit

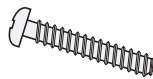

Wood Screw x 5pcs.



Washer x 4 pcs.

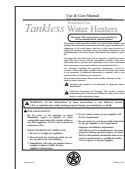

Use & Care Manual

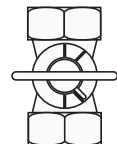

Manual Appliance  
Gas Shut-off Valve



## Mounting the Water Heater

**CAUTION:** Reinforcement of the wall is required in case the wall is not strong enough to hold the appliance.

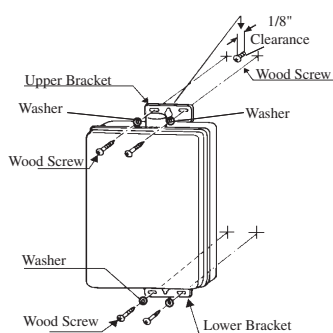

Make sure the location of the appliance allows for easy access and operation.

Wall studs should be utilized when mounting the water heater to the wall.

In case of dry wall or concrete wall use dry wall anchors or lag bolts.

Install a wood screw for the upper bracket with a clearance of 1/8" between the wall and the screw head. Hang the center of the upper bracket on the screw.

Using a wood screw and a washer, affix the lower bracket to the wall (Left and Right). Repeat to affix the top bracket.

The brackets can be adjusted to change the distance between the back of the appliance and the wall within the range of 3/8" to 1 1/2".

Loosen the adjustment screws of both the top and the bottom brackets to adjust the distance. (See diagram below)

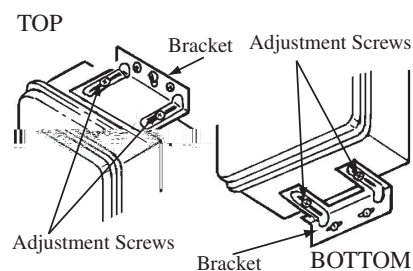

**IMPORTANT:** Do not apply heat to the HOT or COLD water connections. If sweat connections are used, sweat tubing to adapter before fitting adapter to the water connections on heater. Any heat applied to the water supply fittings will permanently damage the internal components of the water heater.

**CAUTION:** This water heater must only be used with the following water supply system conditions:

- With clean, potable water free of corrosive chemicals, sand, dirt, or other contaminants.
- With inlet water temperatures above 32°F, but not exceeding 120°F.
- Free of lime and scale deposits.
- DO NOT reverse the hot and cold water connections. The water heater will not operate.

## Water Supply Connections

Plumbing should be carried out by a qualified plumber in accordance with local codes.

Use approved plumbing materials only.

All material between the water supply and the water heater must be metal.

The diameter of the pipe lines should be a minimum of 3/4".

To conserve energy and to prevent freezing, insulate both cold and hot water supply lines. DO NOT cover the drain or pressure valves.

To ensure proper operation of the water heater, the following water pressure guidelines should be followed:

- Operation of the water heater requires the minimum water pressure of 14 psi and a minimum water flow rate of 0.66 gpm.
- Additional water pressure is required for long pipe runs and outlet fitting(s) water pressure drops.
- To maintain proper performance, ensure sufficient water supply pressure. The Required Water Pressure = Min. Operating Water Pressure (14 psi) + Pipe Pressure Loss + Faucet and Shower Pressure Loss + Safety Margin (more than 5 psi).

- To supply hot water to upper floors, additional water pressure (0.44 psi/ft) must be ensured. The measurement should be calculated by the distance between the water inlet of the water heater (ground level) to the hot water faucet (upper floor level).
- Well water systems should be set at a range of 50-60 psi.
- When the water is supplied from a water supply tank, the height of the tank and the diameter of the pipes and their relation to water pressure, should be taken into consideration. **Gravity water pressure is not recommended.**

**Notice:** If the water flow resistance of a shower head is too high, the burner in the water heater will fail to ignite. Keep the shower head clean from debris that could cause additional pressure drop.

**Notice:** If using mixing valves on the outlet, choose one which prevents cold water pressure from overcoming hot water line pressure.

# Installing the water heater.

## Water Supply Connections Continued.

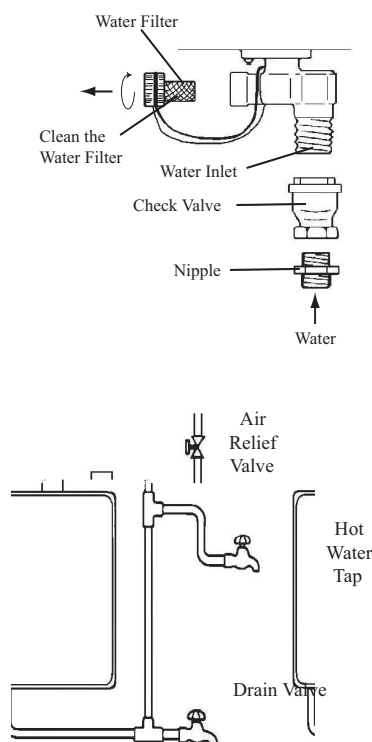

Install a shutoff valve near the inlet of the water heater for service and draining purposes.

DO NOT use pipes with smaller diameters than the water supply connection of the water heater.

Before connecting the water supply pipe to the water heater, open the shutoff valve and clean out sand, debris, air, caulking material, etc. inside the pipe. Connect to the water inlet, then check water flow. Close the shutoff valve and clean the water filter.

Be sure to connect the water inlet and the hot water outlet as shown on the water heater. If reversed, the water heater will not function.

Installation of unions or flexible copper connections are recommended on the HOT and COLD water lines, so that the water heater may disconnect easily for servicing if necessary.

Install a Check Valve between the water heater and the water shutoff valve. (See illustration the top left).

The following should be addressed in regards to the HOT WATER OUTLET:

- Connections between the water heater and point(s) of use should be as short and direct as possible.
- DO NOT use lead or plastic pipe.
- To conserve energy and minimize heat loss, insulation of hot water piping is recommended. (See Hot and Cold Pipe Insulation Installation on page 17).

**Notice:** The flow rate of hot water may vary when more than two faucets (appliances, fixtures, etc.) are being used simultaneously.

**Notice:** The pipes MUST be completely drainable. If the hot water faucets are located at a point higher than the water heater, place a drain valve at the lowest point (see diagram to the left).

## Relief Valve

**A new pressure relief valve, complying with the Standard for Relief Valves and Automatic Gas Shut-Off Devices for Hot Water Supply Systems, ANSI Z21.22, must be installed at the hot water outlet connection of the water heater at the time of installation. Local codes shall govern the installation of relief valves.**

For safe operation of the water heater, be sure that:

- The pressure rating of the relief valve must not exceed 150 psi, the maximum working pressure of the water heater as marked on the rating plate.
- The BTUH rating of the relief valve must equal or exceed the BTUH input of the water heater as marked on its rating plate.
- No valve of any type should be installed between the relief valve and the water heater
- Discharge from the relief valve should be piped to a suitable drain to eliminate potential water damage. Piping used should be of a type approved for the distribution of hot water.
- Hot and cold water lines should be insulated up to the water heater. Refer to page 17 for details.

- The discharge line must be NO SMALLER than the outlet of the valve and must pitch downward to allow complete drainage (by gravity) of the relief valve and discharge line.
- The end of the discharge line should not be threaded or concealed and should be protected from freezing. No valve of any type, restriction or reducer coupling should be installed in the discharge line.

**Notice:** Local codes govern the installation of relief valves. If local codes require that a temperature and pressure relief valve should be installed the manufacturer recommends a type 40XL Watts T&P relief valve or an equivalent model be used.

**Notice:** Manual operation of relief valves should be performed at least once a year. Turn off the electrical power and gas shutoff valve. Lift and release lever on the relief valve and check the manual operation of the relief valve. You should take precaution to avoid contact with the hot water coming out of the relief valve and to prevent water damage.

**Notice:** If the relief valve on the system discharges periodically, a problem exists and service to the water system is required.

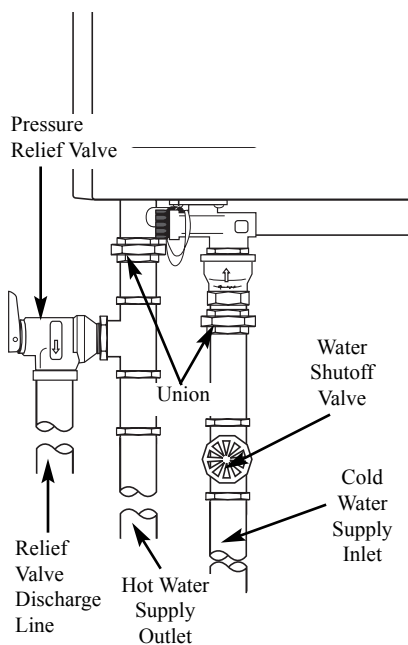

**Notice:** The above illustrates a pressure only relief valve. If local codes require a combination temperature and pressure relief valve be installed, an extension piece may be needed. (Refer to page 16 for example of extension piece for T&P relief valve installation.)

**⚠ WARNING:** Do not attempt to convert this water heater for use with a different type of gas other than the type shown on the rating plate. Such conversion could result in hazardous operating conditions.

## Gas Supply

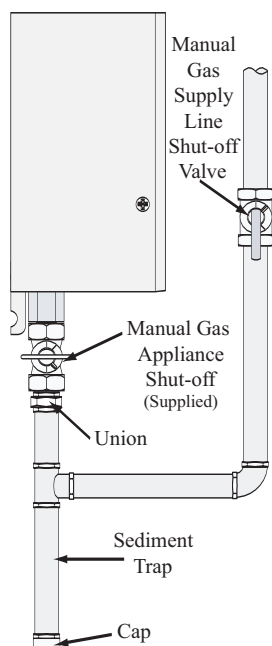

It is recommended that a Manual Gas Appliance Shutoff Valve be installed at the gas connection of the water heater at the time of installation (see diagram to the left).

The branch gas supply line to the water heater should be clean 3/4" black steel pipe or other approved gas piping material.

A ground joint union or ANSI design certified semi-rigid or flexible gas appliance connector should be installed in the gas line close to the water heater. The National Fuel Gas Code (NFGC) mandates a manual gas shut-off valve: See (NFGC) for complete instructions.

If flexible connectors are used, the maximum length shall not exceed 36".

If lever type gas shut offs are used, they shall be T-Handle type.

Compound used on the threaded joints of the gas piping must be of the type resistant to the action of LP gas. Use compound sparingly on male threads only.

A sediment trap should be installed at the bottom of the gas line.

Do not use excessive force (over 31.5 ft lbs.) in tightening the pipe, particularly if teflon pipe compound is used, as the unit may be damaged.

The inlet gas pressure to the water heater must not exceed 10.5" w.c. for natural or 14" w.c. for LP gas. For purposes of input adjustment, the minimum inlet gas pressure (with main burner on) is shown on the water heater rating plate. If high or low gas pressures are present, contact your gas supplier for correction.

**⚠ WARNING:** Never use an open flame to test for gas leaks, as property damage, personal injury, or death could result.

## Leak Testing

The water heater and its gas connections must be leak tested at normal operating pressures before it is placed in operation.

- 1 Turn on the gas shut-off valve(s) to the water heater.
- 2 Use a soapy water solution to test for leaks at all connections and fittings. Bubbles indicate a gas leak that must be corrected.

The factory connections should also be leak tested after the water heater is placed in operation.

**⚠ WARNING:** Install a gas pressure regulator, in the gas supply line, which does not exceed the maximum supply pressure.

**DO NOT** use an industrial type gas regulator.

## Pressure Testing the Gas Supply System

The water heater and its manual gas shut-off valve must be disconnected from the gas supply piping system during any pressure testing of the system at pressures in excess of 1/2 psi (14" w.c.).

The water heater must be isolated from the gas piping system by closing the manual gas shut-off valve during any pressure testing of the gas supply piping at pressures equal to or less than 1/2 psi (14" w.c.).

## High Altitude

Ratings of gas appliances are based on sea level operation and need not be changed for installations at elevations up to 3,280 feet.

**NOTICE:** For installations above 3,280 feet, the connector on the PC board must be replaced for High Altitude installations. Please contact your local distributor, dealer, or Rheem for replacement connector.

# Installing the water heater.

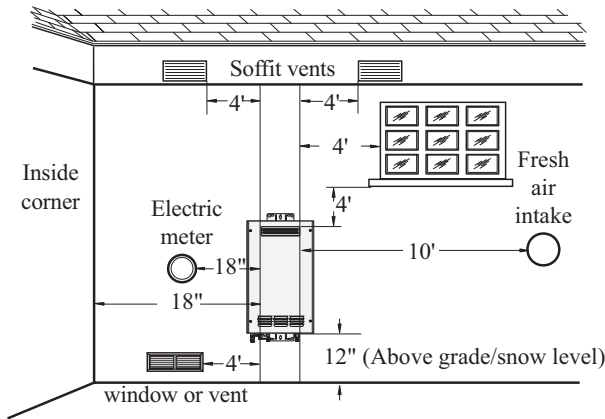

## Flue Terminal Location

The location of the vent terminal depends on the following minimum clearances and considerations (see illustration):

- 1 Twelve (12) inches above grade level and above normal snow levels.
- 2 Four (4) feet below, or four (4) feet horizontally from any door, window, soffit, under eave vent or gravity air inlet to the building or other appliances, or from gas or electric meters. Do not locate vent above walkways, doors, windows, air inlets, gas or electric meters or other equipment.
- 3 Ten (10) feet from any forced air inlet to the building. Any fresh or make-up air inlet such as for a dryer or furnace area is considered to be a forced air inlet.
- 4 Eighteen (18) inches from an inside corner formed by two exterior walls.

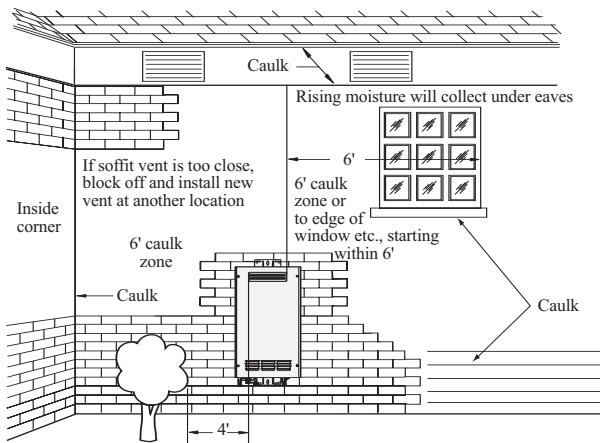

## Additional Considerations

- 1 Do Not install the water heater under any patio or deck.
- 2 To help prevent moisture from freezing on walls and under eaves, do not locate vent terminal on the side of a building with prevailing winter winds.
- 3 Do Not locate vent terminal too close to shrubbery, as flue gasses may damage them.
- 4 Caulk all cracks, seams and joints within six (6) feet of vent terminal.
- 5 All painted surfaces should be primed to lessen the chance of physical damage. Painted surfaces will require maintenance.

**⚠ WARNING:** Moisture in the flue gas will condense as it leaves the vent terminal. In cold weather this condensate can freeze on the exterior wall, under the eaves and on surrounding objects. Some discoloration to the exterior of the building is to be expected. However, improper location or installation can result in severe damage to the structure or exterior finish of the building

**▲ WARNING: Field wiring connections and electrical grounding must comply with local codes, or in the absence of local codes, with the latest edition of the National Electrical Code, ANSI/NFPA 70, or in Canada, Canadian Electrical Code, CSA C22.1 Part 1.**

## Remote Control Installation

**NOTICE: The provided remote control will allow a maximum temperature setting of 120°F. If higher temperatures (up to 140°F) is desired, a MAIN (UMC-117) remote control is available (sold separately). Contact your dealer for details.**

One (1) remote control is provided with the water heater. Additional remote controls may be purchased separately. Up to three (3) remote controls can be used with this water heater.

The following are considerations for determining the location of the remote control(s):

- **DO NOT** install any remote control outdoors.
- Place remote control(s) out of children's reach.
- The remote control(s) can be installed in convenient locations such as the kitchen, laundry room, utility room, or directly beside the water heater.
- The included remote control can be placed in a convenient location in a bathroom, however, **AVOID** areas where water may come into contact with the control(s).
- Avoid areas where the remote control(s) may be exposed to heat, e.g. stove ranges or heaters.

- Avoid areas where the remote control(s) may be subjected to oil and/or steam from cooking.
- Avoid areas where chemical agents (such as thinner, benzene and alkaline) are used.
- Avoid areas of direct sunlight.
- The **MAXIMUM** distance between the water heater and the remote control(s) installation location is limited to 195 feet.

**NOTICE: Only one of each type of remote controls can connect to the water heater. Therefore, a maximum of three controls can connect to the water heater.**

**No other manufacturer's controls are suitable for use with this water heater.**

**DO NOT attempt to disassemble the remote control.**

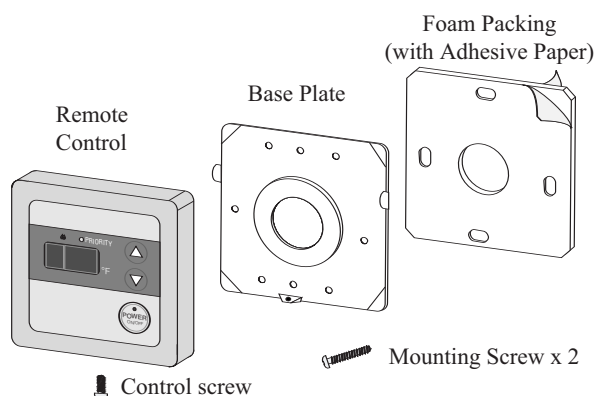

Remote Control Model Number	Remote Control Description	Temperature Set Point Range	Availability
USC1-117	BATH1	100°F - 120°F	Provided
USC2-117	BATH2	100°F - 120°F	Optional (Sold separately)
UMC-117	MAIN	100°F - 140°F	Optional (Sold separately)

# Installing the water heater.

**▲ WARNING: Field wiring connections and electrical grounding must comply with local codes, or in the absence of local codes, with the latest edition of the National Electrical Code, ANSI/NFPA 70, or in Canada, Canadian Electrical Code, CSA C22.1 Part 1.**

## Remote Control Installation Continued...

**NOTICE: Extension cable can be any Type-T 18 AWG wire similar to a thermostat wire and is not polarity sensitive.**

**Do Not apply sealant to the remote control cable.**

**It is not recommended to have wiring exposed.**

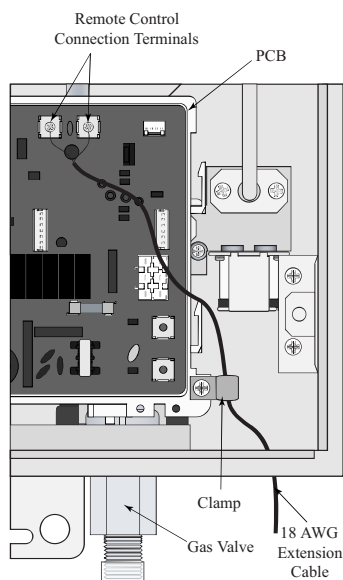

Connecting BATH1 (supplied) and/or BATH2 (sold separately) remote control to the water heater:

- Drill a 1" to 1.5" hole at the proposed control location.
- Install the extension cable between the location of the remote control and the water heater.
- Remove the base plate from the control.
- Peel off one side of the adhesive paper from the foam packing and adhere to the back face of the base plate (This is the side without the projections).
- Peel off the remaining adhesive paper from the foam packing.
- Draw the remote control extension cable through the central in the base plate.
- Fix the base plate to the wall using suitable screws and wall anchors. Ensure the projections on the base plate are pointing upwards.
- Connect the remote control cables to the extension cable from the water heater.
- Place the remote control over the base plate. Ensure the projections in the base plate fit into the housings in the remote control(s).
- Fix the control to the base plate at the bottom of the remote control using the screw provided.
- Proceed to "Connection the remote control to the water heater" section to complete installation.

Connecting the remote control(s) to the water heater:

- Ensure that the power to the water heater has been disconnected.
- Remove the front cover of the water heater.
- Insert the remote control extension cable through the hole at the bottom right hand corner of the water heater.
- Connect the wires to the terminals on the top right hand side of the Printed Circuit Board (PCB) as shown in illustration to the left.

**NOTICE: The remote control wire connection terminals are not polarity sensitive.**

- Firmly tighten the terminal screws.
- Secure the remote control extension cable using the appropriate clamp.
- Replace the front cover of the water heater.
- Switch on the power supply to the water heater.
- Ensure proper operation of the remote control(s) and water heater.

**Notice: The BATH controls can be connected in parallel as described above, or in series by attaching the extension cable(s) to the terminals on the back of the MAIN remote control.**

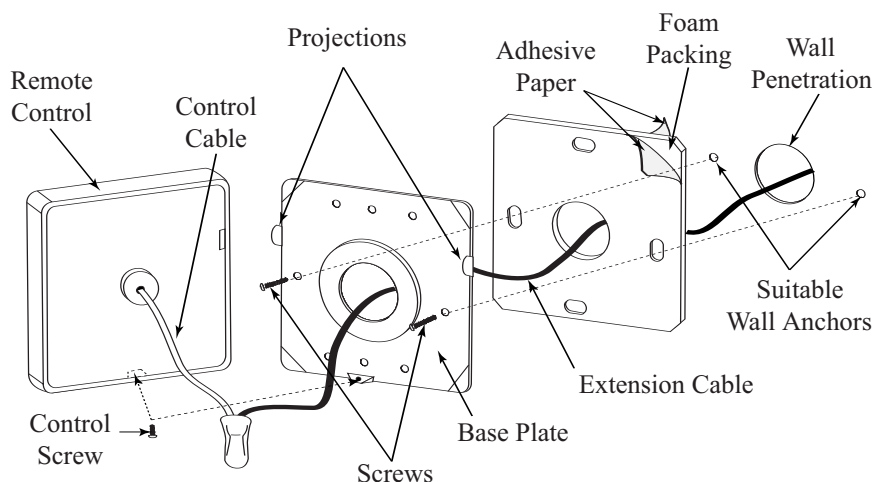

**⚠ WARNING: Field wiring connections and electrical grounding must comply with local codes, or in the absence of local codes, with the latest edition of the National Electrical Code, ANSI/NFPA 70, or in Canada, Canadian Electrical Code, CSA C22.1 Part 1.**

## Electrical Connection

**⚠ WARNING: Shock hazard line voltage is present. Before servicing the water heater, turn off the electrical power to the water heater at the main disconnect or circuit breaker. Failure to do so could result in severe personal injury or death.**

**⚠ CAUTION: Label all wires prior to disconnection when servicing controls. Wiring errors can cause improper and dangerous operation. Verify correct operation after servicing.**

### HARDWIRING THE ELECTRICAL CONNECTIONS:

- Wiring should be carried out by a qualified electrician in accordance with local codes.
- The water heater requires 120 VAC/60Hz and should be properly grounded.
- DO NOT connect grounding wire to water pipes, gas pipes, telephone cables, lightning conductor circuits and to grounding circuit of other equipment that carry a ground-fault interrupter.
- An ON/OFF switch must be provided and installed for the incoming 120VAC power.
- Wire the water heater exactly as shown below. A wiring diagram is also found inside of the cover panel.
- A green screw is provided in the junction box for grounding connection.
- Connect the live wire to black leg wire and the neutral wire to the white neutral wire.

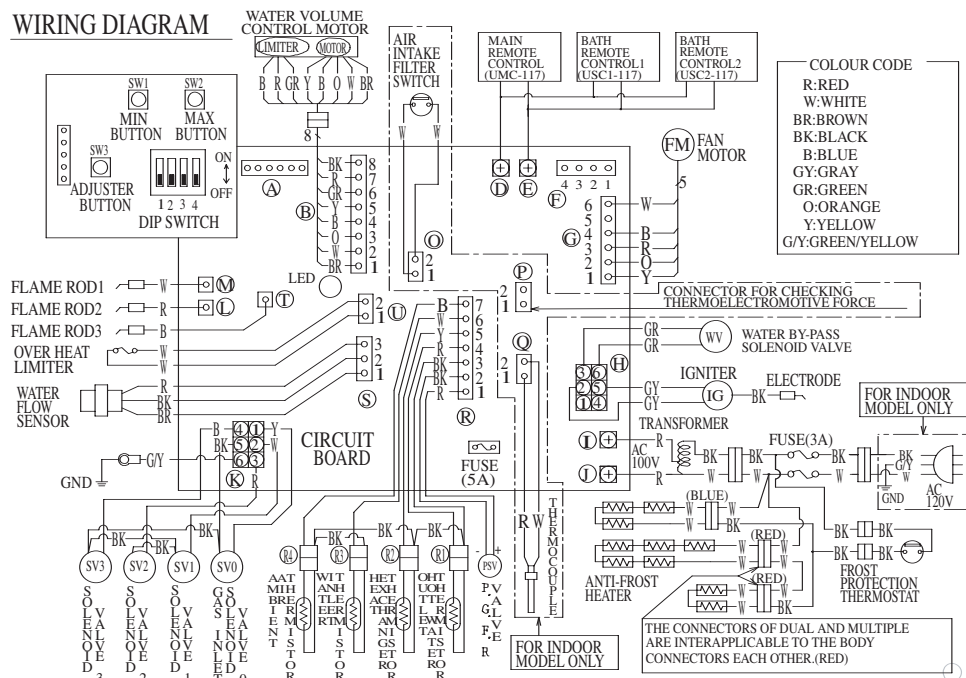
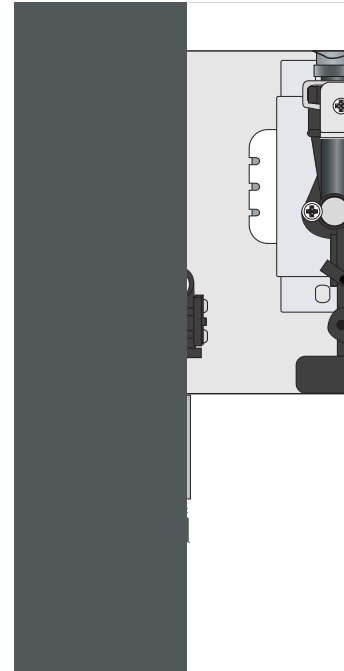

# Installing the water heater.

## Typical Installation

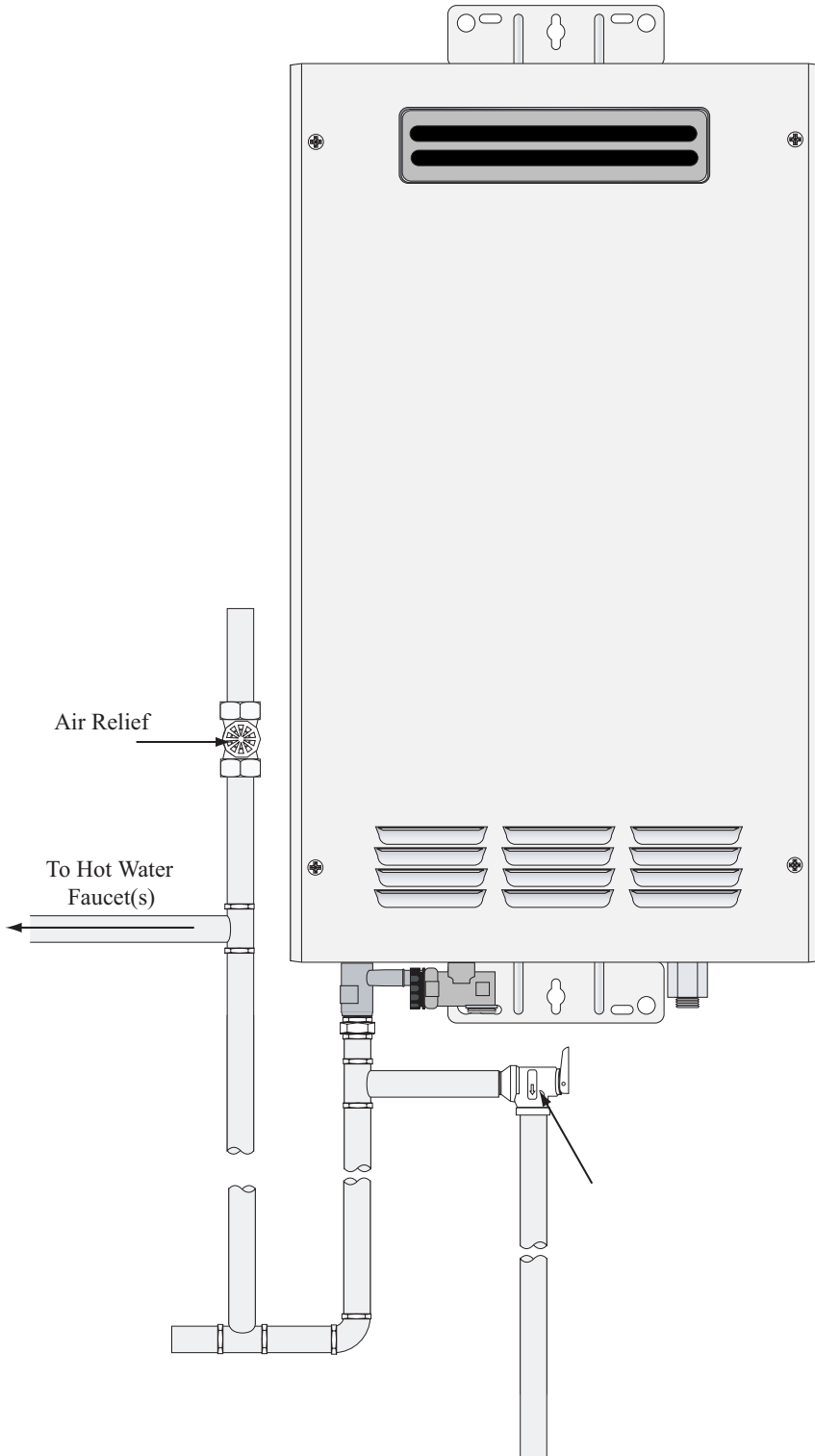



---

## Insulation Blankets

**▲ WARNING:** If local codes require external application of insulation blanket kits the manufacturer's instructions included with the kit must be carefully followed.

Insulation blankets, available to the general public, for external use on gas water heaters are not necessary. The purpose of an insulation blanket is to reduce the standby heat loss encountered with storage tank heaters. This water heater does not store water making an insulation blanket unnecessary.

The manufacturer's warranty does not cover any damage or defect caused by installation, attachment or use of any type of energy saving or other unapproved devices (other than those authorized by the manufacturer) into, onto or in conjunction with the water heater.

The use of unauthorized energy saving devices may shorten the life of the water heater and may endanger life and property.

The manufacturer disclaims any responsibility for such loss or injury resulting from the use of such unauthorized devices.

---

## Hot and Cold Pipe Insulation Installation

**NOTICE:** The hot and cold pipes should be insulated as shown to provide additional freeze protection.

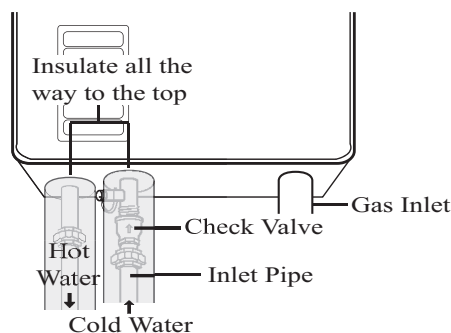

For increased energy efficiency, use pipe insulation. Please install the insulation, according to the illustrations above,

making sure to insulate all the way to the top. **Do not** cover any drain or pressure valve(s).

---

## During Installation of this water heater.....

### Do's

- Do** check inlet gas pressure to ensure that it is within the range specified on the rating plate.
- Do** provide adequate air for combustion and ventilation as discussed in the Use & Care Manual and the National Fuel Gas Code (CAN/CGA B149 in Canada).
- Do** maintain proper clearances to combustibles as specified on the nameplate.
- Do** ensure that the flue terminal location complies with the guidelines found in the Use & Care Manual and National Fuel Gas Code (CAN/CGA B149 in Canada).

### Don'ts

- Don't** block or restrict Air Intake Opening located bottom of the water heater.
- Don't** remove the front cover unless absolutely necessary. This should only be done after being examined by a qualified service technician.
- Don't** install this product where standing water may occur.

# Installing the water heater.

---

## Installation Check List

### A Water Heater Location

- Installed OUTDOORS.
- Close to area of mostly used outlet.
- Protected from freezing temperatures.
- Proper clearance from combustible surfaces observed.
- Sufficient fresh air supply for proper operation of water heater.
- Air supply free of corrosive elements and flammable vapors.
- Provisions made to protect area from water damage.
- Sufficient room to service heater.
- Combustible materials, such as clothing, cleaning materials, rags, etc. clear of the heater and vent piping.
- Water heater is properly attached to the wall.

### B. Water Supply

- Water supply has sufficient pressure.
- Air purged from water heater and piping.
- Water connections tight and free of leaks
- Water filter is clean and in place.
- Materials used are as instructed in this manual.
- Water pipes are insulated.

### C. Gas Supply

- Gas type matches rating plate.
- Gas supply pressure is sufficient for the water heater.
- Gas line equipped with shut-off valve, union and sediment trap.
- Approved pipe joint compound used.
- Soap and water solution used to check all connections and fittings for possible gas leak.
- Gas Company inspected installation (if required).

### D. Relief Valve

- Pressure Relief Valve properly installed and discharge line run to open drain
- Discharge line protected from freezing.

### E. Electrical Wiring

- Voltage matches rating plate.
- Water heater is properly grounded.
- Wiring meets all local codes.
- Water heater is hardwired.



## Safety Precautions

**Do** turn off manual gas shut-off valve if water heater has been subjected to over heating, fire, flood, physical damage or if the gas supply fails to shut off.

**Do Not** turn on water heater unless water and gas

**⚠ DANGER: There is a hot water scald potential if the temperature is set too high. Households with small children, disabled, or elderly persons may require a 120°F or lower temperature setting to prevent contact with HOT water.**

## Water Temperature Setting

The temperature of the water in the water heater can be regulated by setting the temperature on the front of the remote control.

Safety factors should be considered when selecting the water temperature setting of the water heater's temperature.

The remote control was set at 100°F before the water heater was shipped from the factory. This is the recommended starting point.

Water temperatures above 125°F can cause severe burns or death from scalding.

Be sure to read and follow the warnings outlined in this manual and on the label located on the water heater.

Mixing valves are available for reducing point of use water temperature by mixing hot and cold water in branch water lines. Contact a licensed plumber or the local plumbing authority for further information. (See page 4 for more details.)

The chart below may be used as a guide in determining the proper water temperature for your home.

---

## Time/Temperature Relationship in Scalds

Water Temperature	Time To Produce a Serious Burn
120°F	More than 5 minutes
125°F	1½ to 2 minutes
130°F	About 30 seconds
135°F	About 10 seconds
140°F	Less than 5 seconds
145°F	Less than 3 seconds
150°F	About 1½ seconds
155°F	About 1 second

Table courtesy of Shriners Burn Institute

## Water Temperature Setting...

Maximum water temperature occurs while the burner is on. To determine the water temperature, turn on a hot water faucet and place a thermometer in the water stream. Water temperature at the faucet may vary depending on season and length of pipe from the water heater.

This water heater contains an electronically controlled thermostat. From the factory, the temperature range is between 100°F and 120°F.

The remote control is factory preset to 100°F.

To turn the remote control ON or OFF, press the POWER button.

To adjust the temperature to a required setting, press the UP arrow temperature button.

Pressing the UP or DOWN temperature adjustment buttons will change the temperature set point by 2°F.

The temperature set point on the remote control cannot be increased above 112°F when the hot water faucet is in the open position.

**Notice:** The factory setting allows operating temperatures between 100°F and 120°F. Temperatures of up to 140°F can be achieved with the MAIN (UMC-117) (sold separately) remote control and a dip switch adjustment. Contact the dealer, distributor, or Rheem to purchase the MAIN (UMC-117) remote control.

Only qualified service personnel should perform this adjustment. Only factory authorized remote control(s) should be used.

The hottest temperature water will be at the hot water faucet closest to the water heater.

Always remember to test the water temperature with your hand before use and remember that hotter water increases the risk of scald injury.

Always supervise young children or others who are incapacitated.

The water heater is equipped with a device that will shut off the gas supply to the burner if the water heater exceeds normal operating temperatures. Refer to the (Before You Call For Service) section located near the back of this manual, or contact your dealer.

**▲ WARNING:** Should overheating occur or the gas supply fail to shut off, turn off the manual gas control valve to the appliance.

If the water heater has been subjected to fire, flood or physical damage, turn off the manual gas shut-off valve(s), and do not operate the water heater again until it has been checked by qualified personnel.

**Notice:** The water heater may not operate with a small water flow. In such case, increase the water flow. If water heater still does not operate and hot water faucet is completely open, increase the temperature setting on the remote control.

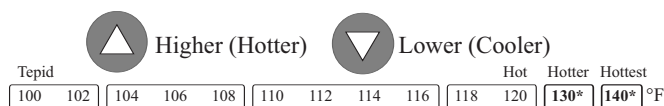
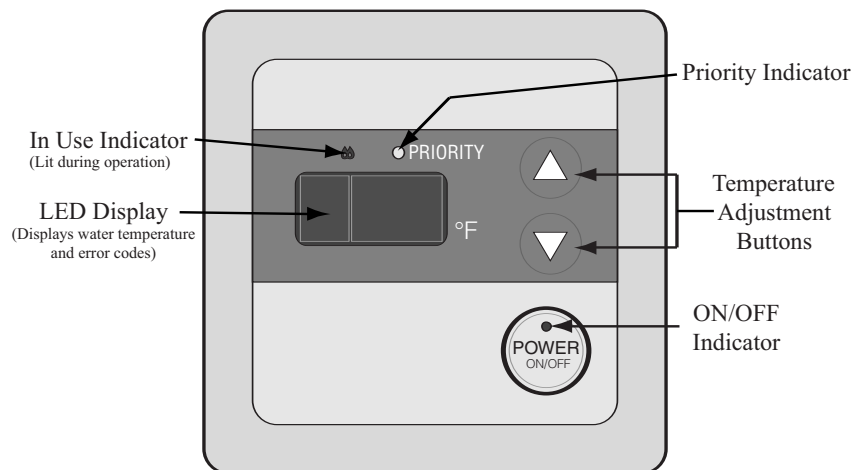

\*Requires the optional MAIN (UMC-117) remote control (Sold Separately).

**NOTICE:** If the BATH control is turned on, the temperature setting on the MAIN control cannot be changed. The BATH control(s) will always have PRIORITY over the MAIN control.

# Care and cleaning of the water heater.

---

**DANGER:** Before manually operating the relief valve, make certain no one will be exposed to the danger of the hot water released by the valve. The water may be hot enough to create a scald hazard. The water should be released into a suitable drain to prevent injury or

## Routine Preventative Maintenance

Properly maintained, your water heater will provide years of dependable trouble-free service.

It is recommended that a periodic inspection of the burner, relief valve, air intake, water filter and flue terminal should be made by service personnel

It is suggested that a routine preventive maintenance program be established and followed by the user.

At least once a year, lift and release the lever handle on the pressure relief valve, located in the hot outlet piping of the water heater, to make certain the valve operates freely. Allow several gallons to flush through the discharge line to an open drain.

**NOTICE:** If the pressure relief valve on the hot water heater discharges periodically, this may be due to a problem in the water system. Contact the water supplier or your plumbing contractor on how to correct this. **DO NOT plug the relief valve outlet.**

Rapid closing of faucets or solenoid valves in automatic water using appliances can cause a banging noise heard in a water pipe. Strategically located risers in the water pipe system or water hammer arresting devices can be used to minimize the problem.

Inspect the area around the water heater to ensure a safe operating environment. Keep appliance area clear and free from combustible materials, gasoline, and other flammable vapors and liquids.

Ensure the unit has not been damaged. If damage or denting is present, contact a service personnel to verify proper operation.

Check for any abnormal sounds during normal operation of the water heater.

All piping should be checked for gas and/or water leaks. Refer to page 11 of this manual for instructions on leak testing.

The cold water supply filter should be cleaned monthly. Refer to the "Housekeeping" section for further information.

**DO NOT** operate the water heater if you feel something is wrong with the unit.

**DO NOT** allow children to operate or otherwise handle the unit.

**Notice:** After inspection, maintenance, and/or cleaning, ensure proper operation by turning on a hot water faucet.

---

## Housekeeping

Before performing Housekeeping tasks to this water heater, turn the unit off and disconnect the power supply.

Vacuum around the water heater for dust, dirt and lint on a regular basis.

Clean the water heater and remote control by using a damp soft cloth with a few drops of mild detergent and gently wiping the surfaces of the unit. Wipe any remaining moisture with a dry soft cloth.

To ensure sufficient ventilation and combustion air supply, proper clearances must be maintained.

The water filter should be cleaned on a monthly basis.

### HOW TO CLEAN THE WATER FILTER:

- Make sure the unit is OFF and the electrical power supply has been disconnected.
- Turn the water supply OFF to the heater.
- Unscrew the water filter, and slide the filter out.
- **DO NOT** tap the filter as it may deform and/or damage the filter.
- To remove severe dust, use a soft brush and wash with running water.
- Return the filter to the water heater and screw in the filter.
- Turn the electrical power supply and cold water supply ON to the water heater.

# Care and cleaning of the water heater.

---

## Housekeeping continued

### CLEANING THE REMOTE CONTROL(S):

- Make sure the unit is OFF and the electrical power supply has been disconnected.
- **DO NOT** scrub the appliance with a brush.
- Use only mild soapy water, other cleaners may damage the surface of the water heater.
- **DO NOT** remove any label including the rating plate while cleaning or servicing.
- **DO NOT** splash water on the remote controls when cleaning.

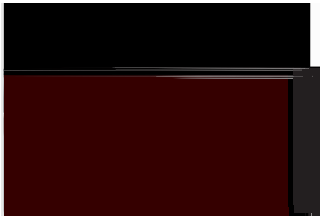

Proper burner pattern.

## Burner Inspection

Visually inspect the main burners annually.

Through the sight glass, inspect the burner flame with the main burner off and inspect the main burner while firing.

If any unusual burner operation is noted, the water heater should be shut off until qualified service assistance can be obtained.

**⚠ CAUTION:** For your safety, cleaning of the main burner should be performed only by qualified service personnel.

For cleaning, a vacuum cleaner can be used on the burner.

---

## Vacation and Extended Shut-Down

**NOTICE:** Refer to the Freeze Protection Section on page 24.

If the water heater is to remain idle for an extended period of time, the power and water to the appliance should be turned off.

The water heater and piping should be drained if they might be subjected to freezing temperatures.

After a long shut-down period, the water heater's operation and controls should be checked by qualified service personnel.

# Care and cleaning of the water heater.

## Draining the Water Heater

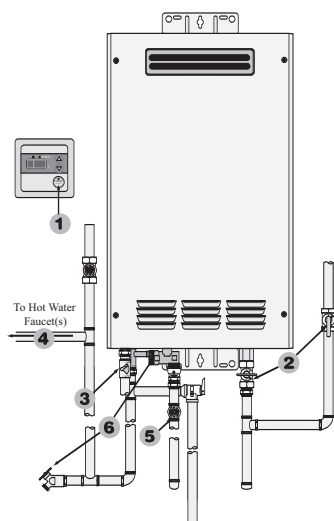

Draining the water heater

**⚠ WARNING: Failure to follow these instructions while draining the water heater can cause serious damage to the water heater as well as personal injury including scalding.**

Below are instructions for draining water out of the water heater.

- 1 Turn off the switch on the remote control.
- 2 Close the gas shut-off valve(s).
- 3 Turn the on/off switch to the OFF position and disconnect breaker at least 10 seconds after step #1.
- 4 Open all hot water faucets. Before proceeding to the next step, make sure that COLD water is coming out of all hot water faucets.
- 5 Close the water shut-off valve.
- 6 Using a suitable container to catch water, remove the water filter from heater. Attach a garden hose to the drain valve installed in the hot water outlet line and direct the stream of water to a suitable drain where it will cause no damage. Approximately 21oz of water will be drained. Leave water heater as is until next use.

To put the water heater back into operation after draining, follow the steps below.

- 1 Reinstall the water filter. Close the hot water outlet drain valve.
- 2 Open the water shut-off valve and close again after making sure that water comes out from hot water faucets. (This step is to remove air from the water lines.)
- 3 Reconnect the breaker and turn the on/off switch to the ON position, fully open the gas shut-off valve and the water shut-off valve.

**NOTICE:** The water heater may not operate unless the above procedure is followed correctly.

**⚠ WARNING: Failure to drain the water heater can cause serious damage to the water heater as well as personal injury.**

**NOTICE: DO NOT unplug the electric power supply cord for freeze protection.**

## Freeze Protection

Where the water heater may be exposed to freezing conditions, even for a short period of time, be sure to drain all water from the unit as instructed above.

Exposure to freezing conditions can occur from down draft of venting system or from installation in areas exposed to cold air.

The water heater is equipped with a Freeze Protection Electric Heater. As long as the electricity is supplied to the water heater, it prevents freezing inside the water heater up to an ambient temperature of approximately minus 30°F (without wind-chill factor)

This device only protects the internal components of the water heater. It does NOT protect piping and valves. Therefore, piping and valves should be wrapped with insulation material as instructed on page 17.

Another method of freeze prevention is by running a small volume of water. Running water will protect the water heater, piping and valves.

Follow the steps below to ensure proper water flow through the water heater and piping:

- 1 Turn off the switch on the remote control.
- 2 Close the gas shut-off valve.
- 3 Open the hot water faucet slightly until a stream of approximately 1/8" is flowing. Be sure to check the flow periodically.



# Before You Call For Service...



## Troubleshooting Tips

Save time and money! Review the charts on the following pages first and you may not need to call for service.

This water heater incorporates a combustion shut off device that shuts the operation of the water heater down if undesirable combustion conditions occur. Such as the presence of a blockage of the combustion air inlet vent. Please contact a Qualified Service Technician if this occurs.

Problem	Possible Cause	What To Do
Not enough or no hot water.	Water shutoff valve is not fully opened.	● Check shutoff valve and open fully.
	Hot water faucet is not fully opened.	● Open hot water faucet completely. (The main burner goes off when incoming water volume is inadequate.)
	Water piping is frozen.	● Allow piping to thaw
	No electricity or water supply is cut off.	● Check that proper power is being supplied and/or water supply is adequate.
	Unit is not "ON".	● Turn the unit "ON" by the button on the remote control.
	The temperature may be set too low.	● Increase the temperature setting.
	Mixing Valve malfunction (if applicable).	● Check and replace if necessary.
	Error code displayed on remote controller.	● See instructions for Error Code and if required, contact a dealer for service.
Water not hot enough.	The temperature may be set too low.	● Increase the temperature setting.
	The gas valve is not fully opened.	● Check and open the gas valve fully.
Water too hot.	The temperature is set too high.	● Decrease the temperature setting.
	Water shutoff valve is not fully opened.	● Check shutoff valve and open fully.
	Small amount of water has been heated.	● Allow more water to flow.
Fan continues to rotate after hot water faucet is closed.	This function is to supply hot water when the hot water faucet is reopened.	● Normal operation. There is no need to call for service.

**⚠ CAUTION:** Make certain power to water heater is "OFF" before removing protective cover FOR ANY REASON.

**⚠ CAUTION:** Label all wires prior to disconnection when servicing controls. Wiring errors can cause improper and dangerous operation. VERIFY PROPER OPERATION AFTER SERVICING.

**⚠ CAUTION:** For your safety DO NOT attempt repair of electrical wiring, gas piping, remote control, burners, vent connectors or other safety devices. Refer repairs to qualified service personnel.

# Error Code Guide

When an error code is displayed:

- Close the hot water faucet, turn off the switch on the remote control.
- Wait for about 5 minutes before turning the switch on again.
- Open the hot water faucet.

If the error code remains shown:

- Close the hot water faucet and turn off the switch on the remote control.
- Take the proper action shown below and attempt operation of the appliance again.

If the error code is still shown:

- Turn off the hot water faucet and turn off the switch on the remote control.
- Take note of the error code displayed and call the customer service assistance number in the “If You Need Service” section of the manual on the back cover.

**Notice:** If an error code other than those listed below is displayed, immediately turn off the hot water faucet, take note of the error code, turn off the switch on the remote control and call the customer assistance number.

Error Code	Possible Cause	What To Do
00	The operation automatically stops when used for an hour continuously.	● Close the hot water faucet once. (The water heater can then be used.)
11	The Gas Shutoff Valve is not opened completely.	● Open the Gas Shutoff Valve completely.
12	Gas Service has been interrupted. LP Gas is running low. (LP models only)	● Contact Gas Utility Company. ● Fill up LP Gas container or replace with a new cylinder of LP Gas.
15	The hot water faucet is not opened enough.	● Open the faucet more to secure enough volume.
16	The method of restarting the unit after draining the water from it was not performed in sequence.	● See the section "Draining the Water Heater"
99	Decrease of blower motor ventilation amount. (Operation Stops)	● Clean any blockage from Heat Exchanger Fins and/or Blower Motor
1L	Water heater has a build up of lime	● Contact a dealer for service.

**⚠ CAUTION:** Make certain power to water heater is “OFF” before removing protective cover FOR ANY REASON.

**⚠ CAUTION:** Label all wires prior to disconnection when servicing controls. Wiring errors can cause improper and dangerous operation. VERIFY PROPER OPERATION AFTER SERVICING.

**⚠ CAUTION:** For your safety DO NOT attempt repair of gas piping, remote control, burners, or other safety devices. Refer repairs to qualified service personnel.



# IF YOU NEED SERVICE



1. Should you have any questions about your new water heater, or if it requires adjustment, repair, or routine maintenance, it is suggested that you first contact your installer, plumbing contractor or previously agreed upon service agency. In the event the firm has moved, or is unavailable, refer to the telephone directory, commercial listings or local utility for qualified service assistance.
2. Should your problem not be solved to your complete satisfaction, you should then contact the Manufacturer's National Service Department at the following address:

2600 Gunter Park Drive  
Montgomery, Alabama 36109-1413  
Phone: 1-800-432-8373.

When contacting the manufacturer, the following information will be requested:

- a. Model and serial number of the water heater as shown on the rating plate attached to the front panel of the heater.
- b. Address where the water heater is located and physical location.
- c. Name and address of installer and any service agency who performed service on the water heater.
- d. Date of original installation and dates any service work was performed.
- e. Details of the problem as you can best describe them.
- f. List of people, with dates, who have been contacted regarding your problem.

## Free Manuals Download Website

<http://myh66.com>

<http://usermanuals.us>

<http://www.somanuals.com>

<http://www.4manuals.cc>

<http://www.manual-lib.com>

<http://www.404manual.com>

<http://www.luxmanual.com>

<http://aubethermostatmanual.com>

Golf course search by state

<http://golfingnear.com>

Email search by domain

<http://emailbydomain.com>

Auto manuals search

<http://auto.somanuals.com>

TV manuals search

<http://tv.somanuals.com>