



# *“Streamline Closed Circuit”*

## **GAS BOOSTED SOLAR WATER HEATER OWNER’S MANUAL**

AND

WARRANTY / INSTALLATION INFORMATION

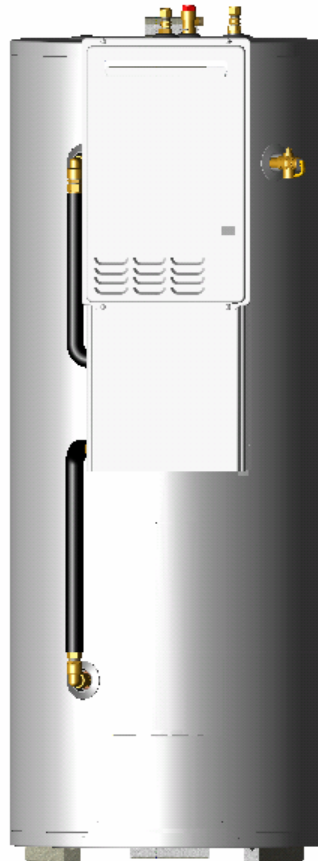

### **WARNING: Plumber – Be Aware**

**Use copper pipe ONLY. Plastic pipe MUST NOT be used.**  
It is a requirement of a solar water heater installation that all pipe work be in copper and not plastic, due to the effects of high water temperatures.

**Solahart Industries Pty Ltd  
ABN 45 064 945 848**

*This water heater must be installed and serviced by an authorised person.  
Please leave this guide with the householder.*

**Notice to Victorian Customers from the  
Victorian Plumbing Industry Commission.**

**This water heater must be installed by a licensed person as required by the  
Victorian Building Act 1993.**

Only a licensed person will give you a Compliance Certificate, showing that the work complies with all the relevant standards. Only a licensed person will have insurance protecting their workmanship for 6 years. Make sure you use a licensed person to install this water heater and ask for your Compliance Certificate.



## **WARNING: Plumber – Be Aware**

- The solar hot and solar cold pipes between the solar storage tank and the solar collectors **MUST BE** of copper and fully insulated with closed cell polymer insulation or similar (minimum thickness 13 mm). The insulation must be weatherproof and UV resistant if exposed. All compression fittings must use brass or copper olives.
- Plastic pipe **MUST NOT** be used, as it will not withstand the temperature of the closed circuit fluid generated by the solar collectors under stagnation conditions. The solar collectors can generate extremely high closed circuit fluid temperatures of up to 150°C. Plastic pipe cannot withstand these temperatures and **MUST NOT** be used. Failure of plastic pipe can lead to the release of high temperature closed circuit fluid and cause severe water damage and flooding. [Refer to Warning on page 28.](#)

**⚠ Warning:** Upon completion of the installation and commissioning of the water heater, leave this guide with the householder or responsible officer. **DO NOT** leave this guide inside of the cover of the water heater, as it may interfere with the safe operation of the water heater or ignite when the water heater is turned on.

### **PATENTS**

This water heater may be protected by one or more patents or registered designs.

® Registered trademark of Solahart Industries Pty Ltd or Rheem Australia Pty Ltd.  
™ Trademark of Solahart Industries Pty Ltd or Rheem Australia Pty Ltd.

# CONTENTS

**HOUSEHOLDER – We recommend you read pages 5 to 16.**  
The other pages are intended for the installer but may be of interest.

<b>Introduction.....</b>	<b>4</b>
<b>About Your Water Heater .....</b>	<b>5</b>
<b>How Your Water Heater Works.....</b>	<b>10</b>
<b>Regular Care .....</b>	<b>12</b>
<b>Save A Service Call .....</b>	<b>13</b>
<b>Installation – Solar Storage Tank.....</b>	<b>17</b>
<b>Installation – Solar Collectors .....</b>	<b>26</b>
<b>Connections – Plumbing.....</b>	<b>29</b>
<b>Connections – Electrical.....</b>	<b>33</b>
<b>Commissioning.....</b>	<b>35</b>
<b>Draining The Water Heater.....</b>	<b>51</b>
<b>Water Supplies.....</b>	<b>52</b>
<b>Warranty .....</b>	<b>53</b>
<b>Solahart Offices .....</b>	<b>56</b>

# INTRODUCTION

Congratulations on choosing a "STREAMLINE CLOSED CIRCUIT GAS BOOSTED" solar water heater. We are confident that your purchase will provide you many years of trouble free hot water.

All over the world, the Solahart name is synonymous with quality in water heating. From humble beginnings in the pioneering days of Western Australia, a reputation has been built up over nearly a century.

In 1905, two enterprising plumbers formed the company known as S. W. Hart, a name that was retained for over 70 years. Even in its early stages, S. W. Hart was involved in the manufacture of metal products for water storage and water heating. Since 1953, S. W. Hart, now Solahart Industries Pty Ltd, has been producing thermosyphon solar hot water systems, which is well over 40 years of hot water experience.

Solahart is the market leader in Australia and a dominant brand throughout the world. Our network of distributors covers over 70 countries in Europe, North America, Africa and Asia. In our home market of Australia, we offer the widest range of thermosyphon solar water heater products, and we are now releasing the "STREAMLINE CLOSED CIRCUIT GAS BOOSTED" active solar hot water system. Our product is positioned within the hot water market as a reliable, durable product with state of the art manufacturing technology.

It is with the above in mind that we at Solahart Industries Pty Ltd are confident that your purchase of the "STREAMLINE CLOSED CIRCUIT GAS BOOSTED" solar water heater will provide you reliable hot water with quality after sales service back up.

**Thankyou**

# ABOUT YOUR WATER HEATER

## MODEL TYPE

Congratulations for choosing a Solahart® water heater. Your Solahart Streamline closed circuit solar water heater is designed for the solar collectors to be roof mounted and the solar storage tank to be installed at ground or floor level. The solar storage tank is suitable for outdoor installation only and with either Solahart 'J' or 'KF' solar collectors. The system is suitable for installation in areas subject to frost or freeze conditions. Freeze conditions occur below 6°C.

## HOW HOT SHOULD THE WATER BE?

The solar control unit will circulate the closed circuit fluid through the solar collectors until a temperature of approximately 75°C is reached in the solar storage tank. During periods of low solar energy gain, the gas booster will boost the water temperature automatically to a minimum 60°C when required.

**Note:** The preset outlet booster temperature setting of the gas booster cannot be adjusted by the householder. The setting can only be adjusted by your nearest Solahart Dealer. The preset outlet booster temperature setting of the gas booster is 60°C.

To meet the requirements of the National Plumbing Standard the temperature setting must not be below 60°C.

**⚠ Warning:** Temperature controllers **must not** be fitted to this water heater as part of a solar water heater system because water at a temperature much higher than the controller setting can be delivered.

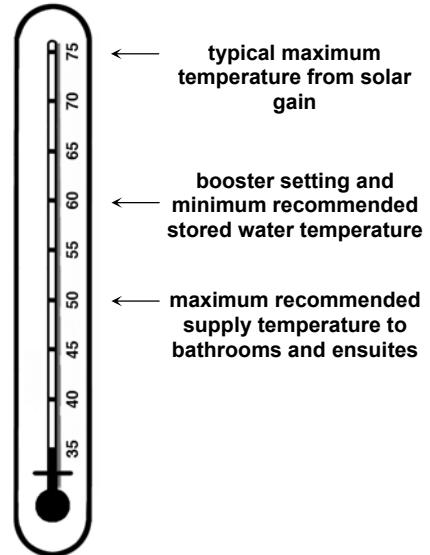

## HOTTER WATER INCREASES THE RISK OF SCALD INJURY

This water heater can deliver water at temperatures which can cause scalding. Check the water temperature before use, such as when entering a shower or filling a bath or basin, to ensure it is suitable for the application and will not cause scald injury.

We recommend and it may also be required by regulations that an approved temperature limiting device be fitted into the hot water pipe work to the bathroom and ensuite when this water heater is installed. This will keep the water temperature below 50°C at the bathroom and ensuite. The risk of scald injury will be reduced and still allow hotter water to the kitchen and laundry.

This water heater has two outlets. One is a hot water outlet and the other is a tempered water outlet. The purpose of the hot water outlet is to deliver hot water at between 60°C and 75°C, usually for kitchen and laundry use. The purpose of the tempered water outlet is to deliver water up to 50°C, usually for bathroom or ensuite use.

## ⚠ WARNING

This water heater is not intended to be operated, adjusted or tampered with by young children or infirm persons. Young children should be supervised to ensure they do not interfere with the water heater.

The water heater uses 240 V AC electrical power for operation of the control systems and the electrically operated components. The removal of the front covers will expose 240 V wiring. They must only be removed by an authorised or qualified person.

The power lead from the water heater must be plugged into a weatherproof electrical outlet. Take care not to touch the power plug with wet hands.

Care should be taken not to touch the pipe work connecting the solar storage tank and the solar collectors. Very high temperature closed circuit fluid can be generated by the solar collectors under certain conditions and flow through the pipe work from the solar collectors to the solar storage tank.

# ABOUT YOUR WATER HEATER

## SAFETY

This water heater is supplied with temperature sensors, a FlameSafe™ protection system, pressure relief valves and a combination temperature pressure relief valve. These devices must not be tampered with or removed. The water heater must not be operated unless each of these devices is fitted and is in working order.

If the power supply cord or plug to the solar storage tank is damaged, it must be replaced by an authorised person in order to avoid a hazard. The power supply cord and plug must be replaced with a genuine replacement part available from Solahart. Phone your nearest Solahart Dealer to arrange for an inspection.

**The warranty can become void if relief valves or other safety devices are tampered with or if the installation is not in accordance with these instructions.**

- Do not store **flammable or combustible materials** near the water heater. Flammable liquids (such as petrol), newspapers and similar articles must be kept well away from the water heater and the flue terminal.
- Do not use **aerosols, stain removers and household chemicals** near the water heater whilst it is working. Gases from some aerosol sprays, stain removers and household chemicals become corrosive when drawn into a flame.
- Do not store **swimming pool chemicals, household cleaners, etc.**, near the water heater.
- Do not place anything on top of the water heater or in contact with the flue terminal. Ensure the flue terminal is not obstructed in any way at any time.
- Do not use Propane / Butane gas mixtures in a Propane model. A Propane model is designed to operate on Propane only. The use of Propane / Butane mixture, such as automotive LPG fuel, in a Propane model is unsafe and can cause damage to the water heater.



## TO TURN OFF THE WATER HEATER

If you plan to be away from home for a few nights, we suggest you leave the water heater switched on.

If it is necessary to turn off the water heater:

- Switch off the electrical supply at the power outlet to the solar storage tank if there is no risk of freezing conditions occurring (refer to note below).
- Close the gas isolation valve at the inlet to the water heater.
- Close the cold water isolation valve at the inlet to the water heater.

**Note:** If there is a risk of freezing conditions, the electrical supply to the water heater should not be switched off unless the gas booster is drained, otherwise damage could result (refer to [“Freeze Protection”](#) on page 8 and [“Draining the Gas Booster Water Heater”](#) on page 9).

# ABOUT YOUR WATER HEATER

## TO TURN ON THE WATER HEATER

- Screw in the drain plugs at the cold water inlet and hot water outlet of the gas booster if the gas booster has been drained.
- Open the cold water isolation valve fully at the inlet to the water heater.
- Open all of the hot water taps in the house (don't forget the shower).

Air will be forced out of the taps.

- Close each tap as water flows freely from it.
- Open the gas isolation valve fully at the inlet to the water heater.
- Plug in the water heater at the power outlet and switch on the electrical supply.

The power outlet must be switched on for the solar controls to operate and solar gain to be achieved and for the gas booster to operate.

The gas booster will operate automatically when you open a hot tap, if boosting is required.

## HOW DO I KNOW IF THE WATER HEATER IS INSTALLED CORRECTLY?

Installation requirements are [shown on page 25](#). The water heater must be installed by an authorised person and the installation must comply with National Standards AS/NZS 3500.4, AS 5601, AS/NZS 3000 and all local codes and regulatory authority requirements. In New Zealand, the installation must conform with the New Zealand Building Code.

Temperature controllers **must not** be fitted (refer to [warning](#) under "[How Hot Should The Water Be?](#)" on page 5).

## PIPE WORK AND INSULATION

The solar hot and solar cold pipe work between the solar storage tank and the solar collectors **MUST BE** of copper and fully insulated with closed cell polymer insulation or similar (minimum thickness 13 mm). The insulation must be weatherproof and UV resistant if exposed. The insulation will offer corrosion protection to a metal roof against water runoff over the copper pipe, assist in avoiding accidental contact with the solar pipe work and also reduce pipe heat losses.

The insulation must be fitted up to the connections on both the solar collectors and the solar storage tank, as very high temperature closed circuit fluid can flow from the solar collectors to the solar storage tank under certain conditions.

There must be a continuous fall in the pipe work from the solar collectors to the solar storage tank. The continuous fall is essential to assist in the drain back function of the solar system.

Plastic pipe **MUST NOT** be used, as it will not withstand the temperature of the closed circuit fluid generated by the solar collectors under certain conditions ([refer to Warning on page 28](#)).

## RAIN WATER TANK

If the solar collectors and solar pipe work are installed on a section of roof which is part of a rain water runoff collection system, then it is recommended this section of roof and its gutter be isolated from the rain water collection system. The gutter should be isolated to a width greater than the solar collectors and pipe work and must have suitable drainage. This is to ensure in the event of a leak from the solar collectors or pipe work, a rainwater tank cannot be contaminated with closed circuit fluid.

The closed circuit fluid contains food grade additives (rust inhibitor and anti-freeze agent), is non-toxic and is harmless to the environment. However, if it enters a rain water tank, it can kill off microscopic algae which are typically present in the water causing an unpleasant odour to develop and resulting in the rain water tank having to be drained and cleaned.

# ABOUT YOUR WATER HEATER

## DOES THE WATER QUALITY AFFECT THE WATER HEATER?

The water heater is suitable for most public water supplies, however some water qualities may have detrimental effects on the cylinder, gas booster heat exchanger and fittings. **If you are in a known harsh water area you must read page 52.** If you are not sure, have your water quality checked against the conditions [described on page 52](#).

## HOW LONG WILL THE WATER HEATER LAST?

There are a number of factors that will affect the length of service the water heater will provide. These include the water quality, the water pressure, temperature (inlet and outlet) and the water usage pattern. However, your Solahart water heater is supported by a comprehensive warranty ([refer to page 54](#)).

## ANODE PROTECTION

The anode(s) installed in your water heater will slowly dissipate whilst protecting the cylinder. The life of the water heater cylinder may be extended by arranging for an authorised person to inspect the anode(s) and replace if required.

The suggested time after installation when the anode(s) should be inspected is 8 years.

For softened water supplies or in areas of poor water quality, it is recommended the anode(s) be inspected 3 years earlier than shown (refer to [“Water Supplies”](#) on page 52).

## FREEZE PROTECTION

### Solar Circuit

The solar circuit must be installed with a continuous fall in the pipe work from the solar collectors to the solar storage tank, the solar hot and solar cold pipes must be fully insulated with closed cell polymer insulation (minimum thickness 13 mm) and the system charged with correctly mixed closed circuit fluid to offer protection against freeze damage. The system has NO WARRANTY for freeze damage if there is not a continuous fall in the solar hot and solar cold pipes, or they are uninsulated, or the closed circuit fluid has been incorrectly mixed (refer to [“Warranty Exclusions”](#) on page 53).

The anti freeze control of the solar circuit is designed so there is no closed circuit fluid in the solar collectors or solar cold and solar hot pipes when the pump is off.

### Gas Booster Water Heater

The gas booster has a frost protection system. The frost protection system will protect the gas booster from damage, by preventing ice forming in the waterways of the gas booster, in the event of freezing conditions occurring.

### Notes:

- The gas booster frost protection system will be rendered inoperable if electrical power is not available at the water heater. Damage caused by freezing due to the unavailability of power at the water heater is not covered by warranty (refer to [“Warranty Exclusions”](#) on page 53).
- If it is necessary to switch the power off to the water heater and there is a risk of freezing, then it is necessary to drain the gas booster (refer to [“Draining the Gas Booster Water Heater”](#) on page 9).
- Pipe work to and from the water heater must be adequately insulated to prevent freezing.
- The water heater is not suitable for installation in areas where the ambient temperature falls below -20°C (including wind chill factor).
- Refer to [“Warranty Exclusions”](#) on page 53.



# ABOUT YOUR WATER HEATER

## DRAINING THE GAS BOOSTER WATER HEATER

- Turn off the water heater (refer to “[Turn Off The Water Heater](#)” on page 6).
- Open a hot tap (preferably the shower outlet).
- Unscrew the two drain plugs, one each at the cold water inlet and hot water outlet, on the underside of the water heater.

Water will drain from the water heater.

- When water stops flowing from the water heater, close the hot tap.

**Note:** It is recommended not to screw the drain plugs back in, until the water heater is to be turned on again.

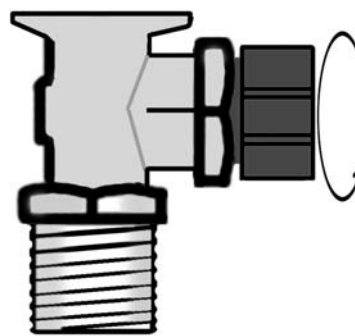
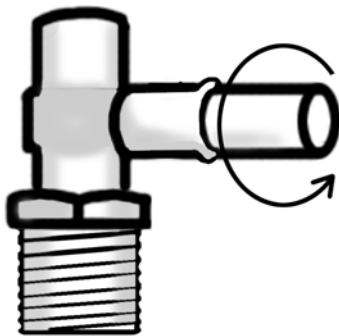

# HOW YOUR WATER HEATER WORKS

## SOLAR OPERATION

The Solahart Streamline closed circuit solar water heater has its vitreous enamel lined solar storage tank installed at ground or floor level, remotely from the solar collectors. This water heater is an indirect solar hot water system with a heat exchanger in the solar storage tank. The heat exchanger is filled with closed circuit fluid and is connected to the solar collectors forming a closed circuit.

As the sun heats the solar collectors, the increase in temperature activates the pump. The pump switches on whenever the solar collectors are hotter than the water in the tank. The pump moves the closed circuit fluid from the solar storage tank heat exchanger through an insulated copper pipe to the solar collectors to be heated by the sun's energy and then back to the heat exchanger. Heat transfers from the closed circuit fluid in the heat exchanger to the water stored in the solar storage tank.

This process continues while solar energy is available and until the water in the solar storage tank reaches a temperature of approximately 75°C. The pump is then deactivated and the closed circuit fluid in the solar collectors and solar pipe work drains back into the heat exchanger in the solar storage tank.

The closed circuit provides protection to the solar collectors and solar circuit in harsh water areas. The drain back principle provides protection to the system in freezing conditions.

Automatic safety controls are fitted to the water heater to provide safe and efficient operation.

## GAS BOOSTING OPERATION

Water stored in the solar storage tank passes through the gas booster when a hot tap is opened. The gas booster is for heating the water at times of low solar energy gain, such as during cloudy or rainy weather, or during winter months.

Solar heated water can reach temperatures up to 75°C in the solar storage tank. When the solar heated water temperature is above 58°C, the gas booster will not boost the water temperature.

The gas booster operates automatically if heating of the water is required. When the solar heated water temperature is below 58°C, the gas burners ignite to provide immediate heating of the water to a minimum temperature of 60°C. The heat produced by the burner is transferred to the water through the heat exchanger. The water is heated to a constant temperature by the automatic adjustment of the gas supply to the burner to suit the water flow rate. The gas burners extinguish when the hot tap is closed.

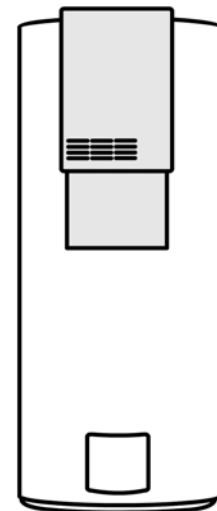

Automatic safety controls are fitted to the water heater to provide safe and efficient operation.

## WATER OUTLET TEMPERATURE

This water heater has two outlets. One is a hot water outlet and the other is a tempered water outlet. The purpose of the hot water outlet is to deliver hot water at between 60°C and 75°C, usually for kitchen and laundry use. The purpose of the tempered water outlet is to deliver water up to 50°C, usually for bathroom or ensuite use.

The tempered water outlet is from the tempering valve, located under the pipe cover at the front of the water heater immediately below the gas booster. The tempering valve is the brass valve with a green plastic cap. The tempering valve mixes hot water from the solar storage tank and gas booster with cold water from the mains supply and delivers tempered water from its outlet.

The hot water outlet is located above the tempering valve. Depending upon how the water heater was installed, either both or only one of these outlets may have been plumbed to the hot water pipe work in the premises.

# HOW YOUR WATER HEATER WORKS

## **MAINS PRESSURE**

The water heater is designed to operate at mains pressure by connecting directly to the mains water supply. If the mains supply pressure in your area exceeds that [shown on page 19](#), a pressure limiting valve must be fitted. The supply pressure should be greater than 350 kPa for true mains pressure operation to be achieved. The supply pressure should be greater than 140 kPa for the rated flow and performance of the gas booster to be achieved.

## **GOING ON HOLIDAYS**

It is not necessary to switch off the electrical supply at the power outlet to the water heater if you are going away. However, if it is necessary to switch off the power to the water heater, refer to [“To Turn Off The Water Heater”](#) on page 6. If the power to the water heater is switched off and there is a risk of freezing, then it is necessary to drain the gas booster (refer to [“Draining the Gas Booster Water Heater”](#) on page 9)

# REGULAR CARE

## TEMPERATURE PRESSURE RELIEF VALVE

This valve is near the top of the water heater and is essential for its safe operation. It is possible for the valve to release a little water through the drain line during each heating period. This occurs as the water is heated and expands by approximately 1/50 of its volume.

Continuous leakage of water from the valve and its drain line may indicate a problem with the water heater (refer to "[Temperature Pressure Relief Valve Running](#)" on page 15).

**⚠ WARNING:** Never block the outlet of this valve or its drain line for any reason.

Operate the easing lever on the temperature pressure relief valve once every six months. **It is very important you raise and lower the lever gently.**

**⚠ WARNING:** Failure to do this may result in the water heater cylinder failing.

If water does not flow freely from the drain line when the lever is lifted, then the water heater should be checked by your nearest Solahart Dealer.

The temperature pressure relief valve should be checked for performance or replaced at intervals not exceeding 5 years, or more frequently in areas where there is a high incidence of water deposits (refer to "[Water Supplies](#)" on page 52).

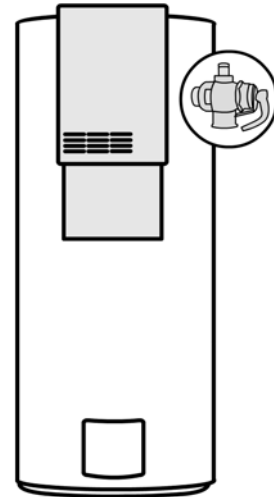

## EXPANSION CONTROL VALVE

In many areas, including South Australia, Western Australia and scaling water areas, an expansion control valve is fitted to the cold water line to the water heater. Water will flow from its drain line during the heating period.

Operate the easing lever on the expansion control valve once every six months. **It is very important you raise and lower the lever gently.** The expansion control valve should be checked for performance or replaced at intervals not exceeding 5 years, or more frequently in areas where there is a high incidence of water deposits.

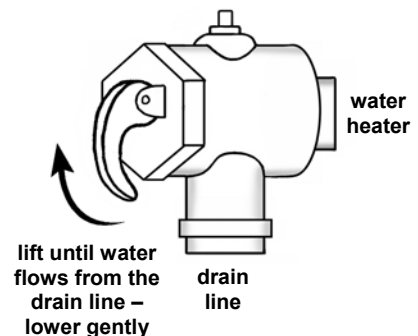

## COLLECTOR GLASS

Ensure the glass on your solar collectors is free of dust, salt spray or any other matter, which may reduce the effectiveness of the solar collectors. If the collector glass becomes dirty, hose down or if the solar collectors are accessible, wash the collector glass with water and a soft brush when the solar collectors are cool. Have any trees trimmed which may shade the solar collectors.

## GENERAL MAINTENANCE

The jacket of the water heater can be cleaned with a soft cloth and warm mild soapy water. Under no circumstances should abrasive materials or powders be used.

## SERVICING

For safe and efficient operation, the water heater should be serviced annually by your nearest Solahart Dealer. Only genuine replacement parts should be used on this water heater.

**⚠ Warning:** Servicing of the water heater should only be carried out by authorised personnel.

## SAVE A SERVICE CALL

Check the items below before making a service call. You will be charged for attending to any condition or fault that is not related to manufacture or failure of a part.

### COLD WATER FROM THE HOT TAP

- Close the hot tap, wait 10 seconds and open the hot tap again.
- Is the hot tap open enough? The gas booster burners will not light if the flow rate is less than 3.0 L / min.
- **Solar control unit and gas booster not operating**
  - Check the power supply cord is plugged in and the power outlet switched on.
  - Is power available in the house? Try using another electrical appliance.
- **Gas supply**
  - Is the isolation valve in the gas line open?
  - Is there a gas supply to the rest of the house? Try lighting another gas appliance.
  - Has the gas line been purged of air after installation? Refer to your plumber.



### NO WATER FROM THE HOT TAP

No flow of water from the hot tap may indicate a restriction in or failure of the cold water supply to the water heater. Check for water flow at other taps and that the cold water isolation valve (refer to page 29) is fully open.

### GAS BOOSTER OPERATING TOO FREQUENTLY

You may find that the gas booster operates more frequently than expected. This will occur when the solar preheat water temperature is lower than 58°C, which may be experienced during periods of low solar energy gain or if there has been heavy hot water usage. Factors to consider are:

- **Insufficient sunlight**

Insufficient sunlight due to cloudy weather during summer months or low solar energy contribution in winter months may mean the gas booster operates more often.
- **Collectors shaded**

If trees or other objects shade the solar collectors or if the glass is dirty, the effectiveness of the solar collectors will be greatly reduced. Have the trees trimmed or the solar collectors relocated if the obstruction is permanent or clean the collector glass (refer to “[Collector Glass](#)” on page 12).
- **Collector area is too small**

For most installations, the number of solar collectors recommended in Solahart literature has been proven to provide the required solar energy to meet the average family needs. However, in some circumstances, it may be necessary to install an additional solar collector.

## SAVE A SERVICE CALL

- **Are you using more hot water than you think?**

Is one outlet (especially the shower) using more hot water than you think?

Very often it is not realised the amount of hot water used, particularly when showering. Carefully review the family's hot water usage. As you have installed an energy saving appliance, energy saving should also be practised in the home. Adjust your water usage pattern to take advantage of maximum solar gains.

Have your plumber install a flow control valve to each shower outlet, basin and sink to reduce water usage.

- **Temperature pressure relief valve running**

Is the relief valve discharging too much water? (Refer to "Temperature Pressure Relief Valve Running" on page 15).

- **Water heater size**

Do you have the correct size water heater for your requirements? The sizing guide in the sales literature and on the Solahart website ([www.Solahart.com.au](http://www.Solahart.com.au)) suggests average sizes that may be needed.

### WATER FLOW FLUCTUATES

More than one or two hot taps in use at the same time may cause a decrease in the hot water flow from the taps.

- Is there more than one or two hot taps open, or are appliances such as a dishwasher or washing machine, in use at the same time?

Ensure only one or two hot taps (or appliance) are on at the one time.

- Check the flow of the water from one tap, eg, the shower.

The shower should be adjusted so the hot tap is fully open.

# SAVE A SERVICE CALL

## TEMPERATURE PRESSURE RELIEF VALVE RUNNING

- **Normal Operation**

It is normal and desirable this valve allows a small quantity of water to escape during the heating cycle. However, if it discharges more than a bucket full of water in 24 hours, there may be another problem.

- **Continuous dribble**

Try gently raising the easing lever on the relief valve for a few seconds (refer to [“Temperature Pressure Relief Valve”](#) on page 12). This may dislodge a small particle of foreign matter and clear the fault. Release the lever gently.

- **Steady flows for long period (often at night)**

This may indicate the mains water pressure sometimes rises above the designed pressure of the water heater. Ask your installing plumber to fit a pressure limiting valve.

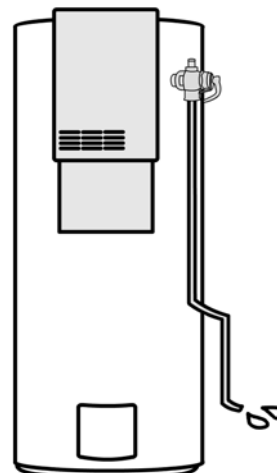

**NEVER** replace the relief valve with one of a higher pressure rating.

- **Heavy flows of hot water until the water heater is cold - then stops until water reheats**

The water heater **must** be switched off at the isolating switch or switchboard. Phone your nearest Solahart Dealer to arrange for an inspection.

## EXPANSION CONTROL VALVE RUNNING

If an expansion control valve is fitted in the cold water line to the water heater ([refer to page 29](#)) it may discharge a small quantity of water instead of the temperature pressure relief valve on the water heater. The benefit is that energy is conserved as the discharged water is cooler.

## PRESSURE RELIEF VALVE DISCHARGING

A pressure relief valve is incorporated into the gas booster controls. This valve protects the gas booster, by allowing water to escape, in the event of excessive pressure build up in the waterways.

- **Normal operation**

A small volume of water may discharge from the bottom of the gas booster when a hot tap is suddenly closed.

- **Continuous dribble**

A continuous dribble may indicate the water supply pressure is above the design pressure for the gas booster. If so, a pressure limiting valve must be installed on the cold water supply pipe to the water heater (refer to [“Mains Water Supply”](#) on page 19).

## FAN CONTINUES TO RUN AFTER WATER HEATER OPERATION STOPS

It is the normal operation of the gas booster for the fan to continue running after heating of the water is finished. The fan may run for up to six minutes after the burners extinguish, to prepare for the next ignition.

# SAVE A SERVICE CALL

## CLOUDS OF WHITE 'VAPOUR' FROM THE FLUE TERMINAL

During the heating cycle, it is not unusual to see water vapour clouds steaming from the flue terminal, particularly on cold days. This is normal operation of the gas booster.

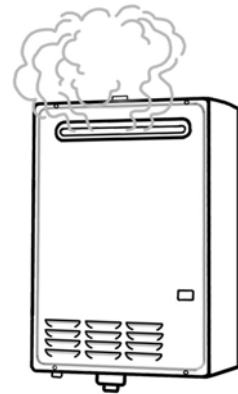

## ERROR CODE

The water heater provides a diagnostic error code in the event of an interruption to its operation. The error code is displayed on the front of the water heater on the OK MONITOR. If an error code appears:

- Close the hot tap and switch off the electrical supply to the water heater.
- Wait 5 minutes, then switch on the electrical supply to the water heater and open a hot tap.

If the error code persists, take note of the code and turn off the hot tap. Phone your nearest Solahart Dealer to arrange for inspection.



## HIGH GAS BILLS

With the installation of your new solar hot water system, maximum gas energy savings can be achieved with careful planning of hot water usage. Should you at any time, feel your gas account is too high, we suggest you check the following points:

- Is the relief valve running excessively? (Refer to [“Temperature Pressure Relief Valve Running”](#) on page 15).
- Is one outlet (especially the shower) using more hot water than you think? (Refer to [“Gas Booster Operating Too Frequently”](#) on page 13).
- Is there a leaking hot water pipe, dripping hot water tap, etc? Even a small leak will waste a surprising quantity of hot water and energy. Replace faulty tap washers, and have your plumber rectify any leaking pipe work.
- Is the gas booster operating too frequently? (Refer to [“Gas Booster Operating Too Frequently”](#) on page 13).
- Consider recent changes to your hot water usage pattern and check if there has been any increase in tariffs since your previous account.



## COLLECTOR GLASS

Warranty **DOES NOT** cover breakage of solar collector glass. Check your household insurance policy covers collector glass breakage.

**⚠ Warning:** Collector glass must not be replaced whilst the solar collector is on the roof.

The collector glass is not offered as a replacement part and no attempt should be made to remove it. Should the solar collector require replacement, contact your nearest Solahart Dealer.

**IF YOU HAVE CHECKED ALL THE FOREGOING AND STILL BELIEVE YOU NEED ASSISTANCE, CALL YOUR NEAREST SOLAHART DEALER.**



# INSTALLATION – SOLAR STORAGE TANK

**THIS WATER HEATER IS FOR OUTDOOR INSTALLATION ONLY.  
THIS WATER HEATER IS NOT SUITABLE FOR POOL HEATING.  
Check the water heater is suitable for the gas type available.  
(refer to the rating label on the water heater)**

The system is suitable for installation with Solahart 'J' or 'KF' solar collectors.

The solar circuit must be installed with a continuous fall of a minimum 5° in the pipe work from the solar collectors to the solar storage tank, the solar hot and solar cold pipes must be fully insulated with closed cell polymer insulation (minimum thickness 13 mm) and the system charged with correctly mixed closed circuit fluid to offer protection against freeze damage. The system has NO WARRANTY for freeze damage if there is not a continuous fall in the solar hot and solar cold pipes or they are uninsulated or the closed circuit fluid has been incorrectly mixed (refer to "[Warranty Exclusions](#)" on page 53).

## SOLAR WATER HEATER STORAGE TANK LOCATION

The solar storage tank is suitable for outdoor installation only. The solar storage tank should be installed close to the most frequently used outlet and its position chosen with safety and service in mind. Make sure people (particularly children) will not touch the flue terminal. The flue terminal and air inlet must be clear of obstructions and shrubbery.

Consideration must also be given to the position of the solar storage tank in relation to the solar collectors. There are limitations on both the maximum length of the solar hot and solar cold pipes and the maximum height between the solar storage tank and the solar collectors. Refer to "[Solar Collector Location](#)" on page 26 and to "[Pipe Lengths](#)" on page 27.

Clearance must be allowed for servicing of the solar storage tank and gas booster. The solar storage tank must be accessible without the use of a ladder or scaffold. Make sure the temperature pressure relief valve lever is accessible and the front panel and front covers can be removed for service.

You must be able to read the information on the rating plate. If possible leave headroom of one water heater length so the anode can be inspected or replaced. Remember you may have to remove the entire solar storage tank later for servicing.

The installation must comply with these installation instructions and with the requirements of AS/NZS 3500.4, AS 5601, AS/NZS 3000 and all local codes and regulatory authority requirements. In New Zealand, the installation must conform with the New Zealand Building Code.



The water heater must not be installed in an area with a corrosive atmosphere where chemicals are stored or where aerosol propellants are released. Remember the air may be safe to breathe, but when it goes through a flame, chemical changes take place which may attack the water heater.

It is recommended the solar storage tank be installed at ground or floor level and must stand vertically upright.

**Note:** It is important for the solar storage tank to be orientated vertically upright in order for the falling film of closed circuit fluid to operate efficiently.

A secondary flue is not required. The water heater must not be installed indoors or in a confined space.

# INSTALLATION – SOLAR STORAGE TANK

The top of the solar storage tank must be a minimum of 500 mm below the bottom of the solar collectors for the system to operate correctly.

As a guide the following requirements extracted from the Australian Gas Installations Standard AS 5601, must be observed.

- At least 300 mm between the top of the gas booster and the eaves.
- At least 300 mm between the gas booster and the edge of any opening into the building, measured horizontally along the wall.
- At least 300 mm between the gas booster and a return wall or external corner, measured horizontally along the wall.
- At least 1500 mm below any openable window.
- At least 1500 mm between the gas booster and any opening into a building, in the direction of the flue discharge.
- At least 500 mm between the gas booster and a fence, wall or other obstruction, in the direction of the flue discharge.

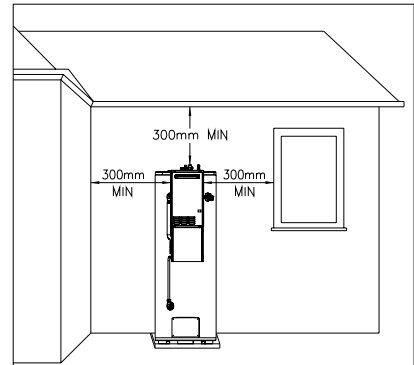

The water heater can be turned through 90°, either to the left or to the right, with the discharge from the flue terminal discharging parallel to the wall. It is important the distance requirements from the Australian Gas Installations Standard AS 5601 are observed.

## FROST PROTECTION

The water heater has a frost protection system. The frost protection system will protect the water heater from damage, by preventing ice forming in the waterways of the water heater, in the event of freezing conditions occurring.

The solar collectors and solar cold and solar hot pipes only contain closed circuit fluid when the pump is operating during periods of solar gain when heating is required. When the solar pump stops operating, the closed circuit fluid drains back into the storage tank heat exchanger. The closed circuit fluid is an anti-freeze agent which, when mixed to the correct specification, can withstand temperatures of -17°C before it may freeze.

The frost protection system to the gas booster will be rendered inoperable if electrical power is not available at the water heater. Damage to the water heater caused by freezing of the pipe work to or from the water heater is not covered under warranty. Refer to AS/NZS 3500.4 for precautions to be taken for installations in frost prone areas. The water heater is not suitable for installation in areas where the ambient temperature falls below -20°C (including wind chill factor).

# INSTALLATION – SOLAR STORAGE TANK

## MAINS WATER SUPPLY

Where the mains water supply pressure exceeds that shown in the table below, an approved pressure limiting valve is required and should be fitted as shown in the installation diagram (refer to diagram on page 29).

Model	270
Relief valve setting	1000 kPa
Expansion control valve setting *	850 kPa
<b>Max. mains supply pressure</b>	
With expansion control valve	680 kPa
Without expansion control valve	800 kPa
<b>Min. mains supply pressure</b>	140 kPa

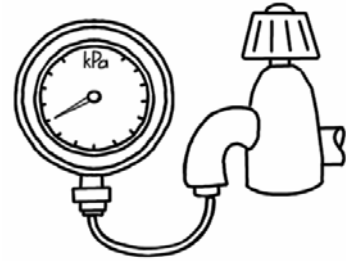

\* Expansion control valve not supplied with the water heater.

## TANK WATER SUPPLY

If the water heater is supplied with water from a tank supply, then a pressure pump system is recommended to ensure a minimum water pressure of 140 kPa is achieved to allow the gas booster to operate. Take care to avoid air locks.

### Notes:

- It is not recommended to install this water heater with a low pressure water supply.
- This water heater is not suitable for connection to bore water or spring water unless a water treatment device is fitted.
- If sludge or foreign matter is present in the water supply, it is recommended a suitable filter be incorporated in the cold water line to the water heater.
- Refer to “Water Supplies” on page 52.

# INSTALLATION – SOLAR STORAGE TANK

## RAIN WATER TANK

If the solar collectors and solar pipe work are to be installed on a section of roof which is part of a rain water runoff collection system, then it is recommended this section of roof and its gutter be isolated from the rain water collection system. The gutter should be isolated to a width greater than the solar collectors and pipe work and must have suitable drainage. The installer should ensure in the event of a leak from the solar collectors or pipe work, a rainwater tank cannot be contaminated with closed circuit fluid.

The section of roof and gutter should be isolated from the rainwater collection system before the commissioning of the solar water heater, so that any leak or spillage during commissioning does not make its way into the rainwater tank.

This section of roof and guttering can be isolated by either:

- blocking this section of gutter from the remaining gutter and fitting two separate down pipes, one to take any run-off water from that section of roof away to waste and the other to the rainwater collection side of the gutter to take the rain water run off to the rain water tank.
- blocking this section of gutter from the remaining gutter and fitting a tube or pipe of a material compatible with the gutter material in this section of the gutter and penetrating the separation pieces at either end to allow rainwater runoff to pass from one part of the rainwater collection system to the other. It may be necessary to fit a down pipe to the section of blocked gutter to take any run-off water from that section of roof away to drain.
- installing a false gutter inside of the existing gutter, with a down pipe penetrating the existing gutter to take any run-off water from that section of roof away to waste. The false gutter should be no deeper than half of the depth of the existing gutter, so as to enable rain water run off to flow under the false gutter.
- installing a flashing from the underside of the roofing material, with a continuous fall, to over the outside lip of the gutter. The flashing should extend wider than the collectors and pipe work and turned up at the ends so if there is leakage of closed circuit fluid, it cannot enter the gutter.

If any of these solutions are not practical, then the installer should discuss alternative options to suit the installation with the house holder.

Any alterations to the roof drainage system must comply with the relevant building regulations, codes and standards.

# INSTALLATION – SOLAR STORAGE TANK

## HOT WATER DELIVERY

This water heater can deliver water at temperatures which can cause scalding. This water heater has both a hot water outlet connection and a tempered water outlet connection. The temperature of the water from the hot water outlet can be up to 75°C and the water from the tempered water outlet can be up to 50°C.

The delivery water temperature requirements of AS/NZS 3500.4 allow water in excess of 50°C to be delivered to fixtures not used primarily for ablution purposes, such as in a kitchen or laundry. These types of fixtures can be supplied from the hot water outlet of this water heater.

It is necessary and we recommend that a tempered water line, from the outlet connection of the temperature limiting device, be fitted between the water heater and the hot water outlets in any ablution area such as a bathroom or ensuite, to reduce the risk of scalding. The installing plumber may have a legal obligation to ensure the installation of this water heater meets the delivery water temperature requirements of AS/NZS 3500.4 so that scalding water temperatures are not delivered to a bathroom, ensuite or other ablution area.

The tempered water outlet from this water heater will not deliver temperatures exceeding 50°C, in accordance with AS 4032.2 There is no statutory requirement to fit a supplementary temperature limiting device if this water heater is installed in other than an early childhood centre, school, nursing home or a facility for young, aged, sick or disabled people.

Where another temperature limiting device is installed adjacent to the water heater, the cold water line to the temperature limiting device can be branched off the cold water line either before or after the isolation valve, pressure limiting valve and non return valve to the water heater. If an expansion control valve is required, it must always be installed after the non return valve and be the last valve prior to the water heater. The hot water line to this temperature limiting device must be taken from the hot water outlet connection of the water heater and not from the tempered water outlet connection of the water heater.

If a pressure limiting valve is installed on the cold water line to the water heater and the cold water line to another temperature limiting device branches off before this valve or from another cold water line in the premises, then a pressure limiting valve of an equal pressure setting may be required prior to the temperature limiting device.

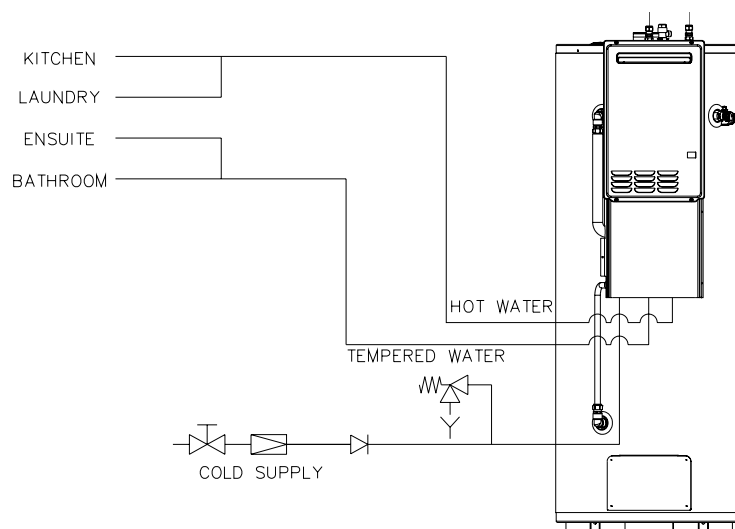

**Two Temperature Zones  
Using Temperature Limiting Device Integrated with Water Heater**

# INSTALLATION – SOLAR STORAGE TANK

## CIRCULATED HOT WATER FLOW AND RETURN SYSTEM

A solar water heater should not be installed as part of a circulated hot water flow and return system in a building. The benefits of solar gain will be significantly reduced and energy gained from the sun lost through the pipe work.

If a circulated flow and return system is required, it is necessary to bypass the solar water heater and install a secondary water heater connected to the hot water flow and return line and supplied from the solar water heater. The secondary water heater must be a storage water heater able to provide a hot water outlet temperature of at least 60°C. **Note:** The thermostat must always be set to at least 60°C. Refer to the [diagram on page 22](#).

## Temperature Limiting Device

A temperature limiting device cannot be installed in circulated hot water flow and return pipe work. The tempered water supplied from the tempered hot water outlet on this water heater or from another temperature limiting device cannot be circulated.

Where a circulated hot water flow and return system is required in a building, a temperature limiting device can only be installed on a dead leg, branching off the circulated hot water flow and return pipe or a dead leg installed from the tempered water outlet of this water heater.

If circulated tempered water were to be returned back to the water heater, depending on the location of the return line connection on the water supply line to the water heater, then either:

- water will be supplied to the cold water inlet of the temperature limiting device at a temperature exceeding the maximum recommended water supply temperature, or
- when the hot taps are closed no water will be supplied to the cold water inlet of the temperature limiting device whilst hot water will continue to be supplied to the hot water inlet of the temperature limiting device.

These conditions may result in either water at a temperature exceeding the requirements of AS/NZS 3500.4 being delivered to the hot water outlets in the ablution areas, or the device closing completely and not delivering water at all, or the device failing. Under either condition, the operation and performance of the device cannot be guaranteed.

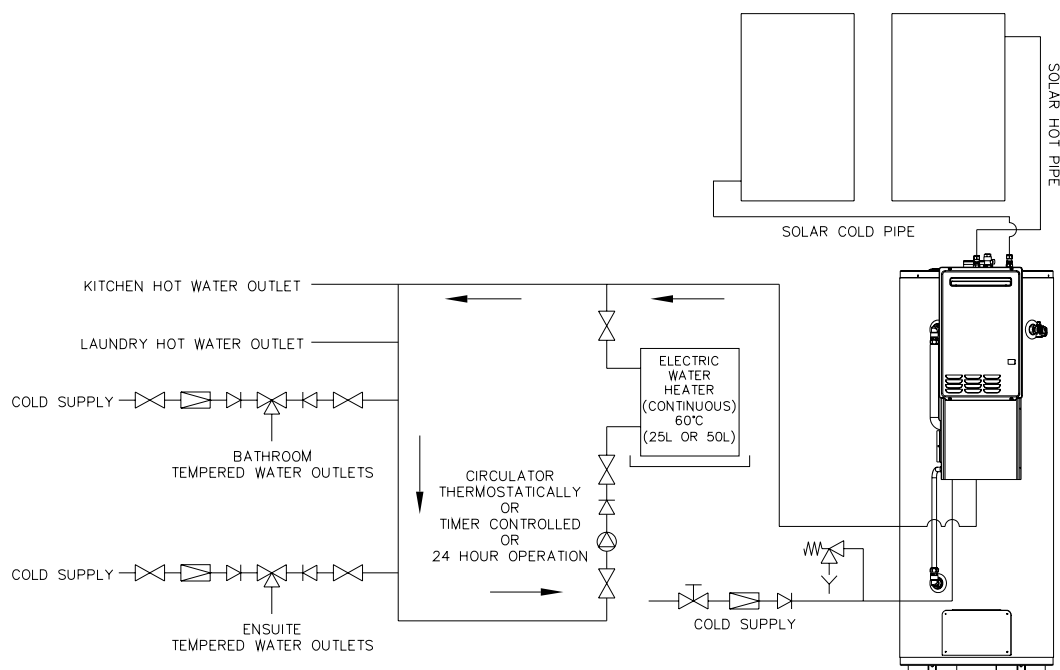

**Circulated Hot Water Flow and Return System – Solar Water Heater**

# INSTALLATION – SOLAR STORAGE TANK

## REDUCING HEAT LOSSES

The cold water line to and the tempered water and hot water lines from the water heater must be insulated in accordance with the requirements of AS/NZS 3500.4. The insulation must be weatherproof and UV resistant if exposed.

The pipe work between the solar storage tank and the solar collectors must be insulated in accordance with the requirements of AS/NZS 3500.4. The insulation must be weatherproof and UV resistant if exposed. The insulation must be fitted up to the connections on both the solar storage tank and the solar collectors.

## ANODE TYPES

The correct anode type for the water supply being used must be fitted in the water heater (refer to “[Water Supplies](#)” on page 52). The black anode is fitted as standard.

Total Dissolved Solids in water supply to the water heater	Anode colour code
0 – 40 mg/L	Green
40 – 600 mg/L	Black
600 – 2500 mg/L	Blue

## SADDLING - PIPE WORK

To prevent damage to the cylinder when attaching pipe clips or saddles to the water heater jacket, we recommend the use of self-drilling screws with a maximum length of 12 mm. Should pre drilling be required, extreme caution must be observed when penetrating the jacket of the water heater.

**Note: Damage to the cylinder as a result of saddling to the jacket will void the warranty.**

# INSTALLATION – SOLAR STORAGE TANK

## DIMENSIONS AND TECHNICAL DATA

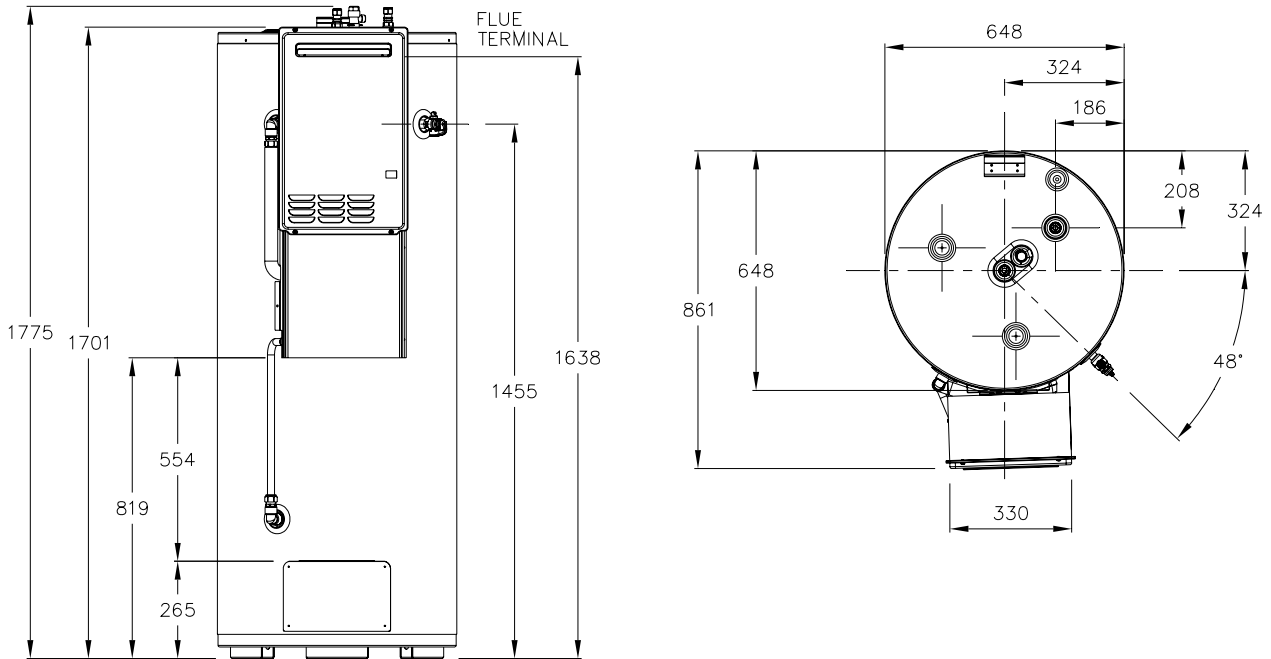

<b>Model</b>	DBV 270	<b>Capacity</b>	270 litres	<b>Mass</b>	165 kg (empty)	435 kg (full)
--------------	---------	-----------------	------------	-------------	----------------	---------------

<b>Gas Booster Details</b>	Gas Booster Model	Delivery 25°C rise (litres / min)	Hourly Gas Consumption (MJ)	Min. Gas Pressure (kPa)	Test Point Gas Pressure (kPa)		Max. Gas Pressure (kPa)
					minimum	maximum	
Natural	271 026 NF	26	199	1.13	0.17	0.91	3.50
Propane	271 026 PF	26	199	2.75	0.22	1.20	3.50

Model numbers: N = Natural, P = Propane. Letter N or P is included in the model number, eg DBV 270 N5, to denote gas type.

Specifications are subject to change with ongoing product improvements.



# INSTALLATION – SOLAR STORAGE TANK

## TYPICAL INSTALLATION – OUTDOOR LOCATION

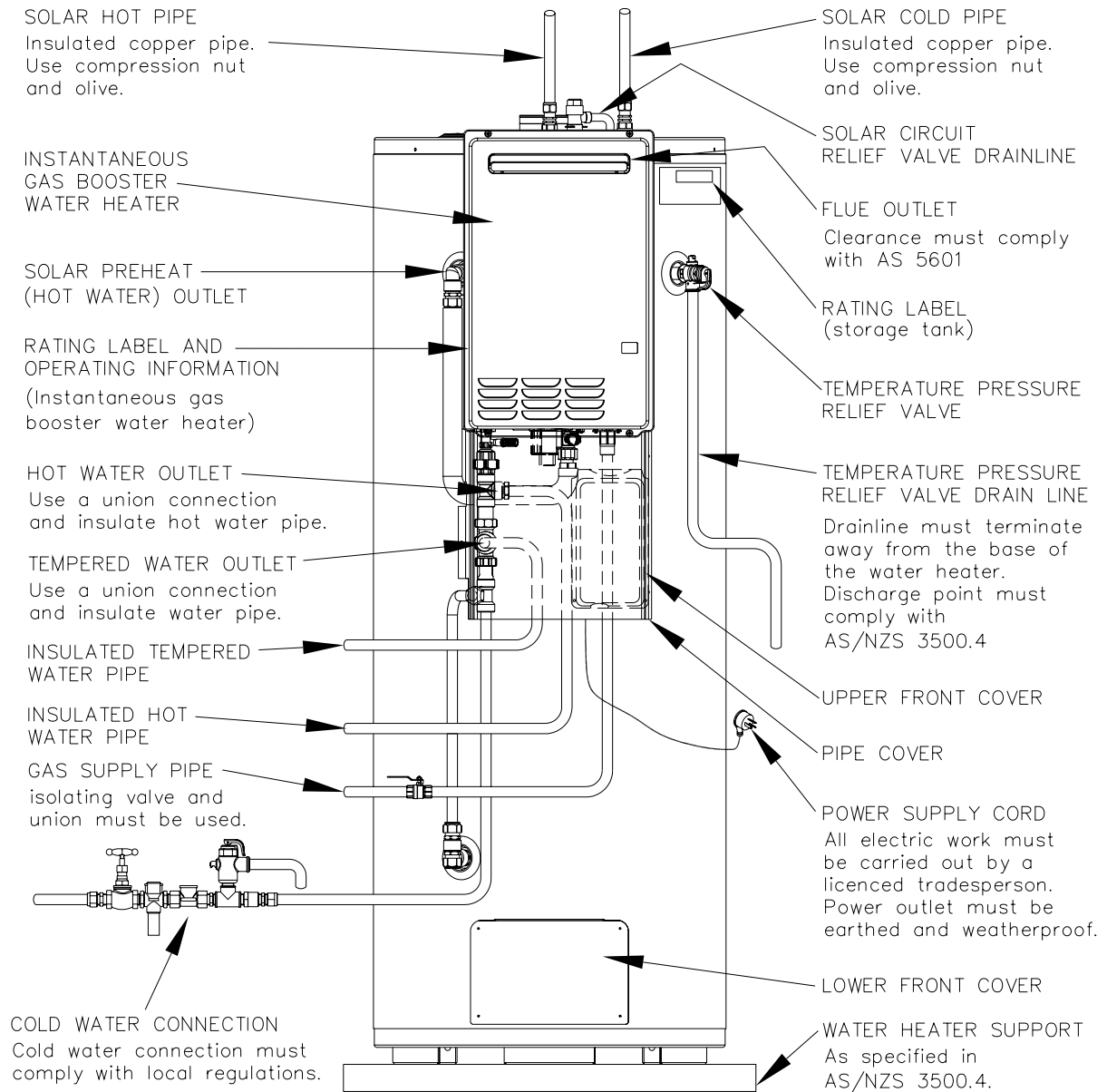

# INSTALLATION – SOLAR COLLECTORS

## SOLAR COLLECTOR LOCATION

Consideration must be given to the position of the solar collectors in relation to the solar storage tank. There are limitations on both the maximum length of the solar hot and solar cold pipes and the maximum height between the solar storage tank and the solar collectors. Refer to “Solar Storage Tank Location” on page 17 and to “Pipe Lengths” on page 27.

- The solar collectors must be installed in a shade free position.
- The solar collectors are to be installed facing toward the equator (i.e. north facing in the southern hemisphere and south facing in the northern hemisphere). Where this orientation is not practical, a system facing up to 45° from the equator will have its efficiency reduced by approximately 5%.
- Inclination of the solar collectors should be approximately equal to 90% of the local latitude angle. The [latitudes of some Australian cities](#) are listed on page 26. Solar collectors may be installed at the roof angle for simplicity of installation and appearance, but must never be less than 10°. If the roof angle varies by 15° from the correct angle, efficiency will be reduced by 10%.
- For an installation on a roof with a pitch less than 10°, a Variable Pitch stand is required. Refer to your local Solar Distributor for details.
- For an installation at right angles to (across) the roof pitch, a Flat Roof stand and an Across Pitch stand are both required. Refer to your local Solar Distributor for details.
- For an installation opposite to (against) the roof pitch, a Flat Roof stand and an Against Pitch stand are both required. Refer to your local Solar Distributor for details.
- The collector kit is suitable for installations with an inclination of up to 45°. Where the solar collectors are installed at inclinations greater than 45°, a With Pitch frame is necessary. Refer to your local Solar Distributor for details.
- The roof must be suitable to take the mass of the solar collectors. Each solar collector and its fittings weighs approximately 45 kg when full of water.
- The installation must comply with the requirements of AS/NZS 3500.4 and all local codes and regulatory authority requirements.
- Refer to the installation instructions supplied with the collector kit for details on the installation of the solar collectors.

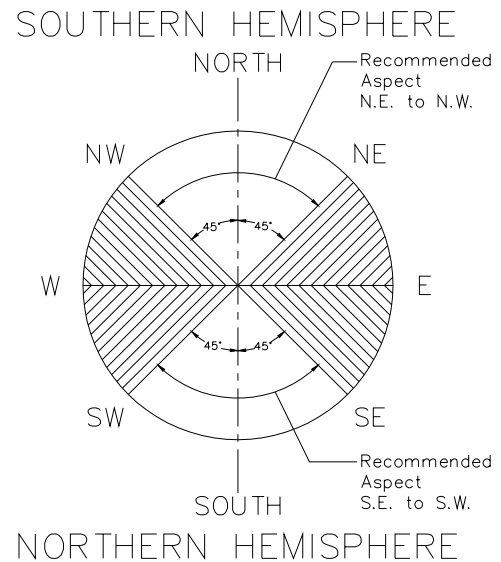

## LATITUDE OF SOME AUSTRALIAN CITIES

Adelaide	35°S	Cairns	17°S	Hobart	42°S	Port Hedland	20°S
Alice Springs	24°S	Canberra	35°S	Mildura	34°S	Rockhampton	24°S
Brisbane	27°S	Darwin	12°S	Melbourne	38°S	Sydney	34°S
Broken Hill	31°S	Geraldton	28°S	Perth	32°S	Townsville	19°S

# INSTALLATION – SOLAR COLLECTORS

## PIPE LENGTHS

The solar hot and solar cold pipes between the solar storage tank and the solar collectors shall:

- be of DN15 hard drawn copper pipe.
- have a continuous fall from the solar collectors to the solar storage tank of a minimum 5° (1 in 10 grade).
- not exceed the maximum recommended lengths as specified in the table.

Maximum recommended total combined pipe length and number of 90° bends				
Pipe Size	1 or 2 Collectors		3 Collectors	
	Pipe Length	90° Bends	Pipe Length	90° Bends
DN15	40 metres	20	30 metres	20

For each additional 90° bend, reduce the maximum total pipe length by 0.5 metres.

For each additional metre of pipe length, reduce the number of 90° bends by two.

Note: One 90° elbow is equal to two 90° bends.

## Notes:

- It is important not to cross connect the solar cold and solar hot pipes to the incorrect connections.
- The solar cold pipe connects to the bottom of the solar collectors and the solar hot pipe connects to the top of the solar collectors diagonally opposite to the solar cold pipe connection.
- The hot sensor connection is at the top of the solar collector, directly above the solar cold inlet connection.
- Refer to [“Warning: Plumber – Be Aware”](#) on page 28.

It is essential for these requirements to be followed for the system to operate correctly and efficiently. Solar pipe work which is oversized, or does not have the correct fall, or is too long can result in the drain back system not operating effectively.

## Maximum Height To Collectors

The solar collectors must be the highest point of the system. The maximum height of the solar installation, from the base of the solar storage tank to the top of the solar collectors, is 9 m. The pump will not circulate closed circuit fluid through heights greater than 9 m and solar gain will not be achieved. For heights greater than 9 m, an auxiliary pump must be installed. Refer to [“Auxiliary Pump”](#) on page 32.

# INSTALLATION – SOLAR COLLECTORS



## WARNING: Plumber – Be Aware

- The solar hot and solar cold pipes between the solar storage tank and the solar collectors **MUST BE** of copper and fully insulated with closed cell polymer insulation or similar (minimum thickness 13 mm). The insulation must be weatherproof and UV resistant if exposed. All compression fittings must use brass or copper olives.  

The insulation will offer corrosion protection to a metal roof against water runoff over the copper pipe, assist in avoiding accidental contact with the solar pipe work and also reduce pipe heat losses.
- The insulation must be **fitted up to the connections on both the solar collectors and the solar storage tank**, as very high temperature closed circuit fluid can flow from the solar collectors to the solar storage tank under certain conditions.
- Plastic pipe **MUST NOT** be used, as it will not withstand the temperature of the closed circuit fluid generated by the solar collectors under stagnation conditions. The solar collectors can generate extremely high closed circuit fluid temperatures up to 150°C. Plastic pipe cannot withstand these temperatures and **MUST NOT** be used. Failure of plastic pipe can lead to the release of high temperature closed circuit fluid and cause severe water damage and flooding.
- There **must be a continuous fall** in the pipe work between the solar collectors and solar storage tank for efficient and effective drain back to occur. The highest point of the solar cold pipe and solar hot pipe must be where they connect to the solar collectors.

# CONNECTIONS – PLUMBING

## CONNECTION SIZES

- Hot water connection: RP $\frac{3}{4}$ /20.
- Cold water connection: RP $\frac{3}{4}$ /20.
- Tempered water connection: RP $\frac{3}{4}$ /20
- Solar hot (from collector) connection: DN15 compression fitting.
- Solar cold (to collector) connection: DN15 compression fitting.
- Temperature Pressure Relief valve connection: RP $\frac{1}{2}$ /15.
- Gas connection: R $\frac{3}{4}$ /20.

All plumbing work must be carried out by a qualified person and in accordance with the National Plumbing Standard AS/NZS 3500.4 and local authority requirements.

All gas work must be carried out by a qualified person and in accordance with the Australian Gas Installations Standard AS 5601 and local authority requirements.

It is necessary to remove the pipe cover from underneath the gas booster, by undoing the retaining screws, in order to make the water and gas connections to the water heater. Refit the pipe cover at the completion of the installation.

## WATER INLET AND OUTLETS

All pipe work must be cleared of foreign matter before connection and purged before attempting to operate the water heater. All olive compression fittings must use brass or copper olives. Use thread sealing tape or approved thread sealant on all fittings.

An isolation valve and non return valve must be installed on the cold water line to the water heater. Use the arrangement shown in the diagram. Refer also to “Hot Water Delivery” on page 21. The plumbing arrangements for the cold water inlet, tempered water and hot water outlets are shown on page 29. The solar hot and solar cold pipe connections are shown on page 32.

A disconnection union must always be provided at the cold water inlet, tempered water and hot water outlets on the water heater to allow for disconnection of the water heater. It is necessary to remove the brass plug from the hot water outlet fitting if a hot water line is to be installed. This plug can be used to plug the tempered water outlet if a tempered water line is not being installed. Refer to the diagram for the connection points to the water heater.

Insulation used on the tempered water and hot water lines must extend up to the outlets of the water heater. The valve and fittings must also be insulated up to the hot water outlet of the gas booster.

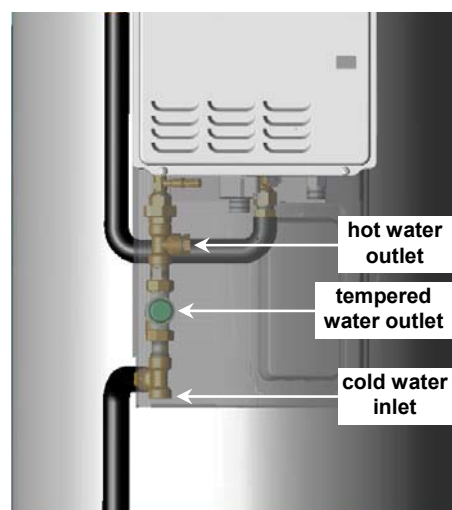
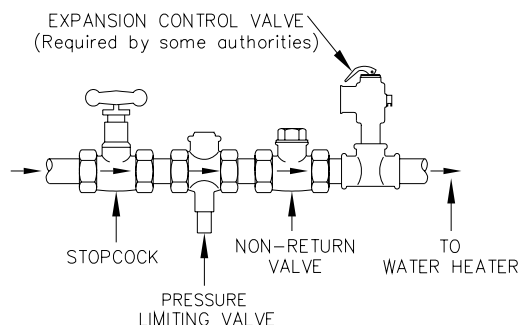

# CONNECTIONS – PLUMBING

This solar storage tank has either a plastic dip tube or fitting liner in the inlet and outlet fittings (see diagram). These must be in place for the water heater to function properly. Do not remove or damage them by using heat nearby. They will be pushed into the correct position as the fitting is screwed in.

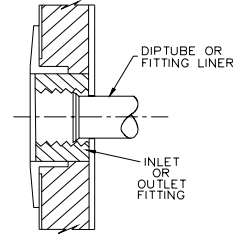

## PIPE SIZES

To achieve true mains pressure operation, the cold water line to the water heater should be the same size or bigger than the tempered water and hot water lines from the water heater. The minimum recommended tempered pipe and hot pipe sizes are DN20.

The pipe sizing for hot water supply systems should be carried out by persons competent to do so, choosing the most suitable pipe size for each individual application. Reference to the technical specifications of the water heater and local regulatory authority requirements must be made.

## RELIEF VALVE

The temperature pressure relief valve is shipped behind the lower front cover of the water heater. The temperature pressure relief valve must be fitted before the water heater is operated. Before fitting the relief valve, make sure the probe has not been bent. Seal the thread with Teflon tape - never hemp. Make sure the tape does not hang over the end of the thread.

Screw the valve into the correct opening ([refer to the installation diagram on page 25](#)) leaving the valve outlet pointing downwards. Do not use a wrench on the valve body - use the spanner flats provided.

## RELIEF VALVE DRAIN

### Temperature Pressure Relief Valve

A copper drain line must be fitted to the relief valve to carry the discharge clear of the water heater. Connect the drain line to the relief valve using a disconnection union. The pipe work from the relief valve to the drain should be as short as possible and fall all the way from the water heater with no restrictions. It should have no more than three right angle bends in it. Use DN15 pipe.

The outlet of the drain line must be in such a position that flow out of the pipe can be easily seen (refer to AS/NZS 3500.4) - but arranged so hot water discharge will not cause injury, damage or nuisance. The drain line must discharge at an outlet or air break not more than 9 metres from the relief valve.

In locations where water pipes are prone to freezing, the drain line must be insulated and not exceed 300 mm in length. In this instance, the drain line is to discharge into a tundish through an air gap of between 75 mm and 150 mm.

**⚠ Warning:** As the function of the temperature pressure relief valve on this water heater is to discharge high temperature water under certain conditions, it is strongly recommended the pipe work downstream of the relief valve be capable of carrying water exceeding 93°C. Failure to observe this precaution may result in damage to pipe work and property.

### Solar Circuit Relief Valve

Ensure the outlet of the solar circuit relief valve is facing toward the rear of the water heater installation. A copper drain line must be fitted to the relief valve to carry the discharge clear of the water heater. Connect the drain line to the relief valve using a disconnection union. The pipe work from the relief valve to the drain should be as short as possible and fall all the way from the water heater with no restrictions. It should have no more than three right angle bends in it. Use DN10 pipe.

The outlet of the drain line must be in such a position that flow out of the pipe can be easily seen (refer to AS/NZS 3500.4) - but arranged so hot water discharge will not cause injury, damage or nuisance. The drain line must discharge at an outlet or air break not more than 9 metres from the relief valve.

# CONNECTIONS – PLUMBING

In locations where water pipes are prone to freezing, the drain line must be insulated and not exceed 300 mm in length. In this instance, the drain line is to discharge into a tundish through an air gap of between 75 mm and 150 mm.

## EXPANSION CONTROL VALVE

Local regulations may make it mandatory to install an expansion control valve (ECV) in the cold water line to the water heater. In other areas, an ECV is not required unless the saturation index is greater than +0.4 (refer to “Water Supplies” on page 52). However, an ECV may be needed in a corrosive water area where there are sufficient quantities of silica dissolved in the water.

The expansion control valve must always be installed after the non return valve and be the last valve installed prior to the water heater (refer to diagram on page 29). A copper drain line must be run separately from the drain of the relief valve.

## GAS INLET

The gas connection is made at the underside of the gas booster. The pipe work must be cleared of foreign matter before connection and purged before attempting to operate the water heater. An isolation valve and disconnection union must be installed to allow servicing and removal of the water heater (refer to the diagram on page 31). Refer to the Gas Installations Standard AS 5601 for the correct pipe sizing.

**Note:** The pipe size selection must take into account the high gas input of the gas booster (refer to table on page 24) as well as all of the other gas appliances in the premises.

**Warning:** Always isolate the gas booster before pressure testing the gas supply system. Disconnect the gas booster after the isolating cock to prevent the risk of serious damage to the gas control. Warranty does not cover damage of any nature resulting from failure to observe this precaution. Refer to rating label for gas types and pressures.



## SOLAR INLET AND OUTLET

All pipe work must be cleared of foreign matter before connection and purged before attempting to operate the water heater. All olive compression fittings must use brass or copper olives. Use thread sealing tape or approved thread sealant on all fittings.

The solar cold outlet and solar hot inlet connections are located at the top of the solar storage tank.

### Notes:

- It is important not to cross connect the solar cold and solar hot pipes to the incorrect connections.
  - The solar cold pipe connects to the bottom of the solar collectors and the solar hot pipe connects to the top of the solar collectors on the opposite side to both the solar cold pipe connection and the hot sensor connection.
  - The solar hot inlet connection is located in the centre of the top of the solar storage tank (the connection is marked by a label on top of the storage tank).
  - The solar cold outlet connection is located toward the outer edge of the top of the solar storage tank (the connection is marked by a label on top of the storage tank).
- Connect the solar pipes to the solar storage tank using only the fittings supplied.



## CONNECTIONS – PLUMBING

To connect the solar cold and solar hot pipes to the solar storage tank:

- Remove the compression nut and olive from each of the solar cold outlet and solar hot inlet fittings at the top of the solar storage tank. Remove the rubber washer from each of the unions and discard.
- Connect the solar cold pipe (flow to the collector) to the nipple in the solar cold outlet using the compression nut and olive supplied.
- Connect the solar hot pipe (flow from the collector) to the nipple in the solar hot inlet using the compression nut and olive supplied.

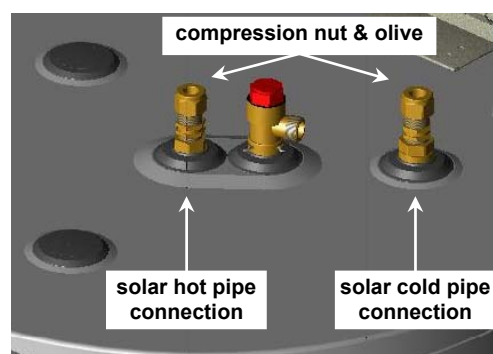

### AUXILIARY PUMP

The maximum height of the solar installation from the base of the solar storage tank to the top of the solar collectors is 9 m. The pump supplied with the solar storage tank will not circulate closed circuit fluid through heights greater than 9 m and solar gain will not be achieved. For heights greater than 9 m, an auxiliary pump must be installed. This pump is the same model as contained within the solar storage tank.

The auxiliary pump (kit PN 299914) is to be installed:

- on the solar cold pipe from the solar storage tank to the solar collectors
- within 1 m of the top of the solar storage tank
- with the inlet and outlet in a vertical orientation
- securely fixed to a structure, such as a wall, with suitable screws or anchors.
- wired to the control board (refer to “[Auxiliary Pump](#)” on page 34).
- within a suitable weatherproof enclosure to protect it from rain as the pump is not weatherproof.

The installation of an auxiliary pump will enable a maximum height of 18 m to be achieved.



## CONNECTIONS – ELECTRICAL

**The power supply to the water heater must not be switched on until the water heater is filled with water.**

### MEGGER READING

It is not mandatory to conduct a megger test on a plug in appliance, however if a megger test is conducted on this water heater, then the following should be noted.

**⚠ Warning:** This water heater contains electronic equipment and 500 V insulation tests must only be conducted between either active and earth or neutral and earth. An active to neutral test WILL damage the electronics.

**An insulation test result of approximately 660 KΩ for this water heater is normal.**

Typically the insulation resistance between live and earthed parts of an electrical installation should not be less than 1 MΩ. However AS/NZS 3000:2000 clause 6.3.3.3.2 'Results' states:

“The value of 1 MΩ may be reduced to:

- 0.01 MΩ for sheathed heating elements or appliances; or
- a value permitted in the Standard applicable to electrical equipment.”

This model water heater is categorised as a 'stationary class 1 motor operated appliance' and has been tested to AS/NZS 3350.1:2002 clause 16 'Leakage current and electric strength' and has passed the requirements of this Standard. Therefore, this model water heater complies with the condition stated in AS/NZS 3000:2000 clause 6.3.3.3.2 (b).

### ELECTRICAL CONNECTION

All electrical work and permanent wiring must be carried out by a qualified person and in accordance with the Wiring Rules AS/NZS 3000 and local authority requirements.

**⚠ Warning:** Temperature controllers **must not** be fitted to this water heater as part of a solar water heater system because water at a temperature much higher than the controller setting can be delivered.

The water heater requires a 240 V AC, 50 Hz mains power supply for operation. The solar storage tank, supplied with a 1.8 metre power cord to operate the solar control unit and gas booster, requires a switched general purpose outlet (GPO) to be located within 1.2 metres of the installation. The GPO must have a continuous power supply. The GPO is required to be weatherproof if installed outdoors.

The power consumption of the water heater is:

Component	Power consumption	Comments
Solar controller	3 Watts	Constant load
Solar pump	165 Watts	Maximum load at solar heating cycle start up (for approximately two (2) minutes)
	50 Watts	Average load during the solar heating cycle
Gas booster	150 Watts	Anti frost device active

The water heater will only operate on a sine wave at 50 Hz. Devices generating a square wave cannot be used to supply power to the water heater.

# CONNECTIONS – ELECTRICAL

## HOT SENSOR LEAD

House the hot sensor lead at the water heater in the flexible conduit provided and secure the conduit in the cut out on the tab located behind the upper front cover. Connect the hot sensor cable to the hot sensor cable connector located on the tab behind the upper front cover. Secure the hot sensor lead to the water heater jacket to prevent possible damage.

## TEMPERATURE SETTING

The preset outlet booster temperature setting of the gas booster should not be adjusted. The setting can only be adjusted by your nearest Solahart Dealer. The preset outlet booster temperature setting is 60°C.

## AUXILIARY PUMP

The auxiliary pump, if installed, must be wired to the control board. The wiring must be housed in a flexible conduit, which must be secured to the side of the solar storage tank. Connect the wiring to the terminals on the auxiliary pump and to the terminals marked “2nd Pump” on the control board. Refer to “Wiring Diagram” on page 34 for the position of the connection.

## WIRING DIAGRAM

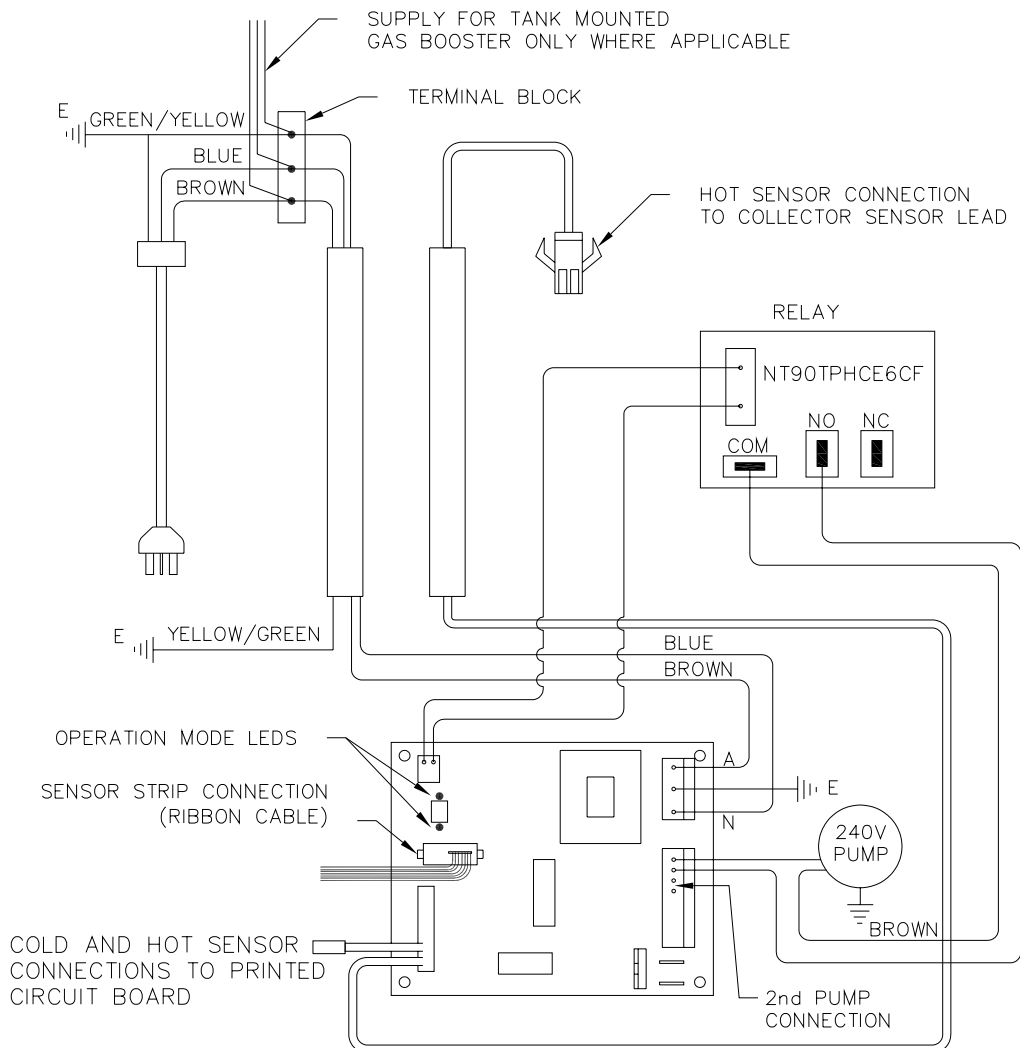

# COMMISSIONING

## TO FILL AND TURN ON THE WATER HEATER

The power supply to the solar storage tank and solar control unit must not be switched on until the water heater is filled with water.

- Open all of the hot water taps in the house (don't forget the shower).
- Open the cold water isolation valve fully on the cold water line to the water heater.  
Air will be forced out of the taps.
- Close each tap as water flows freely from it.
- Check the pipe work for leaks.
- Open the gas isolation valve fully.
- Check the gas pipe work for leaks.
- Open the isolation valve in the pipe work between the outlet of the heat exchanger and the solar pump, located behind the lower front cover of the solar storage tank.
- Plug in the water heater at the power outlet.
- Commission the solar circuit (refer to ["Solar Circuit"](#) on page 36).
- Switch on the electrical supply at the power outlet to the water heater.

The power outlet must be switched on for the solar controls to operate and solar gain to be achieved and for the gas booster to operate and have its frost protection activated.

- Check the gas inlet and burner gas pressure of the gas booster (refer to ["Gas Inlet Pressure"](#) on page 48 and ["Burner Gas Pressure"](#) on page 48).
- Open a hot tap.

The gas booster will operate automatically.

- Check to ensure the flow from each connected hot tap is sufficient to operate the gas booster.

The minimum operating flow rate for all models is 3.0 litres per minute.

Explain to the householder the functions and operation of the solar water heater.

**⚠ Warning:** Upon completion of the installation and commissioning of the water heater, leave this guide with the householder or responsible officer. **DO NOT** leave this guide inside of the cover of the water heater, as it may interfere with the safe operation of the water heater or ignite when the water heater is turned on.

# COMMISSIONING

## SOLAR CIRCUIT

It is necessary to commission and check the operation of the solar circuit. The commissioning procedure includes:

- checking the circulation of closed circuit fluid through the solar circuit.
- checking the drain back function of the solar circuit.
- pressure testing the solar circuit to ensure there are no leaks.
- checking the level of the closed circuit fluid and adjusting if required.

The water heater is supplied charged with closed circuit fluid. The level of the closed circuit fluid only needs to be checked if:

- a third solar collector is installed.
- there is a significant leak in the solar pipe work and closed circuit fluid has been discharged.
- the maximum recommended solar pipe length is exceeded.
- a second solar pump is installed if the maximum height from the base of the solar storage tank to the top of the solar collectors exceeds 9 m (refer to “[Pipe Lengths](#)” on page 27).

## Additional Equipment

Additional equipment will be required for the commissioning and checking of the solar circuit. This includes checking the closed circuit fluid level and conducting a drain back test. The following equipment is required:

- a 1500 mm long x 12 mm ( $\frac{1}{2}$ ”) diameter clear hose (closed circuit fluid level hose).
- one (1)  $\frac{1}{2}$ ” hose clamp.
- a suitable plug for one end of the hose.
- suitable tape to affix the hose to the side of the solar storage tank.
- a torch to illuminate the working area under the heat exchanger and storage tank cylinder.

## Closed Circuit Fluid

The water heater is supplied charged with closed circuit fluid and it is not necessary to add further closed circuit fluid to the system. If the closed circuit fluid has been completely drained or discharged from the solar circuit and needs to be replaced, then the amount to be added is:

- 5 litres of Hartgard concentrate, mixed with
- 11 litres of water.

It is necessary to undertake the solar circuit commissioning procedure if the closed circuit fluid has been replaced.

The closed circuit fluid contains food grade additives (rust inhibitor, anti-freeze agent, colour) and is harmless to the environment. However, it is good practice to recover any excess closed circuit fluid and remove from site.

# COMMISSIONING

**⚠ Warning:** Although non-toxic, the following first aid advice and procedures should be followed if the closed circuit fluid concentrate comes into human contact or is spilled:

- Swallowed - give milk or water and seek medical attention.
- Eyes - wash with running water.
- Skin - remove contaminated clothing and wash skin with water and soap.
- Inhaled - seek fresh air, rest and keep warm.
- Spilt - immediately remove contaminated clothing, stop leak source, absorb with a dry agent and eliminate any ignition sources nearby.

## **⚠ PRE-COMMISSIONING WARNINGS**

- It is recommended to conduct the solar circuit commissioning procedure with the solar collectors covered, otherwise during the commissioning and checking procedure of the solar circuit, the closed circuit fluid may experience solar gain as it passes through the solar collectors. This will increase both the temperature and pressure of the closed circuit fluid and air inside of the solar circuit.
- The electrical supply must be switched off before the solar circuit is opened either at the solar circuit relief valve or at the compression nut on either of the solar hot or solar cold pipes at the top of the solar storage tank.
- If it is necessary to open the solar circuit at the solar circuit relief valve or at the compression nut on either of the solar hot or solar cold pipes at the top of the solar storage tank, then care must be taken so as not to be scalded by either the closed circuit fluid or the air escaping from the solar circuit.

## **Pre-Commissioning Notes**

- Before commencing the solar circuit commissioning procedure, check the solar cold and solar hot pipe work to ensure:
  - there is a continuous fall from the solar collectors to the solar storage tank of a minimum 5° (1 in 10 grade).
  - the maximum recommended pipe length is not exceeded.
  - the maximum height from the base of the solar storage tank to the solar collector is not exceeded.

Rectify the solar pipe work if there is either insufficient fall or not a continuous fall of at least 5° from the solar collectors to the solar storage tank or if either of the maximum pipe length or maximum height of the system has been exceeded, before commencing the solar circuit commissioning procedure. Refer to "[Pipe Lengths](#)" on page 27.

- The solar collectors will gain a high level of heat during periods of solar radiation. If the solar pump is activated during a period of high solar radiation and the solar collectors have not been covered, the initial flow of closed circuit fluid will absorb this heat and a rumbling sound may be heard. This is normal and the solar circuit will achieve a stable operating condition once full flow through the solar circuit is established.
- The solar pump is set on the speed setting 3. This speed setting must not be adjusted. The solar control unit automatically controls and adjusts the speed of the pump to maximise solar contribution. Manual adjustment of the speed dial setting may result in the system not operating correctly or efficiently.

# COMMISSIONING

## Commissioning the Solar Circuit

To commission and check the solar circuit:

1. Switch off the electrical supply at the power outlet to the solar storage tank.

If the pump has been operating, wait five minutes to allow the drain back of the closed circuit fluid in the solar circuit.

2. Remove the pipe cover from below the gas booster and the lower and upper front covers from the solar storage tank.
3. Ensure the isolation valve in the pipe work between the outlet of the heat exchanger and the solar pump, located behind the lower front cover of the solar storage tank, is fully open.



## Attach Closed Circuit Fluid Level Hose

4. Attach the clear hose to the solar circuit.

To attach the hose:

- Ensure the heat exchanger drain valve is closed.  
The heat exchanger drain valve is located adjacent to the solar pump, behind the lower front cover of the solar storage tank.
- Attach one end of the hose to the hose tail connection.  
It may be necessary to secure the hose with a hose clamp.
- Plug the free end of the hose.
- Affix the hose securely in a vertical orientation to the front of the solar storage tank using tape, adjacent to the text, "MINIMUM FLUID LEVEL WITH PUMP OPERATING".

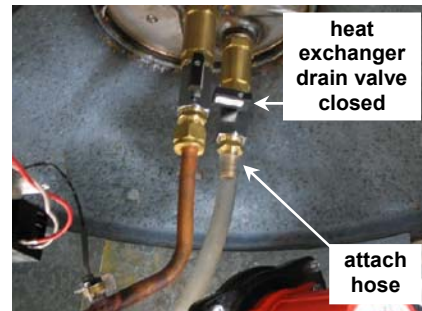

5. Disconnect the drain line from the solar circuit relief valve at the top of the solar storage tank. Remove the spring clip from the solar circuit relief valve and remove the valve.

**⚠ Warning:** The solar circuit may be under pressure. Take care when removing the solar circuit relief valve, as a sudden discharge of pressurised hot air may be experienced. This discharge will create a sharp sound of air being released.



# COMMISSIONING

6. Open the heat exchanger drain valve and remove the plug from the end of the hose.

The closed circuit fluid will flood the hose to the static level of the closed circuit fluid inside of the heat exchanger.

7. Mark the static level of the closed circuit fluid on the side of the solar storage tank with a non permanent marker.



## Solar Circuit Circulation

8. Disconnect the hot sensor lead from the connecting plug located on the tab in the upper front cover opening.

It is important, at the end of this procedure when the commissioning and checking of the solar circuit is complete, to reconnect the hot sensor lead, otherwise when the electrical supply is switched on, the solar pump will deactivate after one hour and the solar control unit will then enter a fault mode and no solar gain will be achieved.

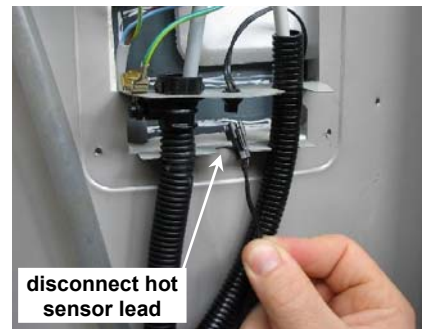

9. Switch on the electrical supply at the power outlet to the solar storage tank.

**⚠ Warning:** Take care not to enter the area inside the solar storage tank behind the front cover whilst the power is on as the electrical circuit will be live.

The pump will activate and commence pumping closed circuit fluid around the solar circuit.

The level of the closed circuit fluid in the clear hose will slowly drop to the dynamic operating level.

Allow the pump to operate for three (3) minutes (one and two collector systems) or for five (5) minutes (3 collector system) to allow the solar circuit to fill with closed circuit fluid and stabilise.

**Note:** The solar pump will operate for one hour with the hot sensor lead disconnected, before automatically turning itself off ([refer to step 12](#)).



# COMMISSIONING

10. Check the closed circuit fluid is circulating around the solar circuit.

To check circulation:

- Listen for the trickling sound of the closed circuit fluid returning into the heat exchanger by placing your ear against the side toward the top of the solar storage tank.

If the fluid is circulating around the solar circuit, a trickling sound will be heard as the fluid returns back into the heat exchanger.

If no trickling sound is heard, check:

- the hot sensor lead is disconnected at the solar storage tank.

If connected, disconnect the hot sensor lead at the solar storage tank (refer to step 8).

- the isolation valve in the pipe work between the outlet of the heat exchanger and the solar pump, located behind the lower front cover of the solar storage tank, is fully open.

**⚠ Warning:** Switch off the electrical supply at the power outlet to the solar storage tank before entering the area inside the solar storage tank behind the front cover.

If closed, open the isolation valve on the outlet of the heat exchanger (refer to step 3).

- there is no leakage from the solar circuit. It is important to check all of the solar circuit pipe work, including in the roof space and on the roof.

If leaking, rectify any leaks in the solar circuit.

- the height from the base of the storage tank to the top of the collectors has not exceeded the maximum allowable height.

- the length of solar cold and solar hot pipe has not exceeded the maximum recommended pipe length.

If the maximum allowable height or the maximum recommended pipe length has been exceeded, it may be necessary to relocate the solar collectors to either a lower level or closer to the solar storage tank, or install a second solar pump, or relocate the solar storage tank closer to the solar collectors. Refer to “Pipe Lengths” on page 27.

11. Mark the dynamic level of the closed circuit fluid in the hose on the side of the solar storage tank with a non permanent marker when satisfied the solar circuit circulation is operating satisfactorily.



12. If the procedure to check the solar circuit circulation is not complete before the pump has automatically turned off, then:

- switch off the electrical supply at the power outlet to the solar storage tank.
- wait ten (10) minutes for the operating system to reset to its commissioning sequence, otherwise the pump will not operate when the power supply is switched on.
- recommence this procedure from step 9.



# COMMISSIONING

## Drain Back Function

13. Switch off the electrical supply at the power outlet to the solar storage tank.

The pump will deactivate.

The closed circuit fluid will drain back down to the heat exchanger and the level of the closed circuit fluid in the clear hose will rise.

Wait five (5) minutes to allow the drain back of the closed circuit fluid in the solar circuit.

14. Note the level of the closed circuit fluid in the fluid level hose.

The closed circuit fluid should drain back to the original static level.

If the closed circuit fluid does not drain back completely to this level, then check:

- there is a continuous fall of at least 5° (1 in 10 grade) in the solar pipe work from the solar collectors to the solar storage tank.
- the solar collectors have an inclination of not less than 10°.  
(refer to “[Solar Collector Location](#)” on page 26)
- the connectors on the inlet and outlet of the collectors are orientated downwards to ensure complete drain back of the closed circuit fluid from the solar collectors.

If necessary, rectify the:

- solar pipe work if there is either insufficient fall or not a continuous fall in the pipe work.
- solar collector inclination if it is less than 10°.
- orientation of the connectors downwards if they are not orientated correctly.

Recheck the drain back function of the solar circuit by repeating [step 7](#) and recommencing this procedure from [step 9](#).

# COMMISSIONING

## Closed Circuit Fluid Level

15. Measure the distance from the text marking “MINIMUM FLUID LEVEL WITH PUMP OPERATING” to the closed circuit fluid dynamic level marked on the side of the solar storage tank during step 11.

The correct closed circuit fluid dynamic level for efficient operation of the system when the pump is operating is between the “MINIMUM FLUID LEVEL WITH PUMP OPERATING” text marking on the side of the solar storage tank and 150 mm above this mark.

- If the closed circuit fluid dynamic level marked on the side of the solar storage tank during step 11 is greater than 150 mm above the text marking, it will be necessary to drain closed circuit fluid from the heat exchanger.
- If the closed circuit fluid dynamic level is below the text marking, it will be necessary to add water to the heat exchanger to top up the level of closed circuit fluid.

There is sufficient Hartgard concentrate in the solar circuit heat exchanger such that only water needs to be added to the system if it is required to top up the level of closed circuit fluid.

**Note:** The operating dynamic level of the closed circuit fluid, upon the completion of commissioning, must not be less than the “MINIMUM FLUID LEVEL WITH PUMP OPERATING” text marking on the side of the solar storage tank or greater than 150 mm above this mark.

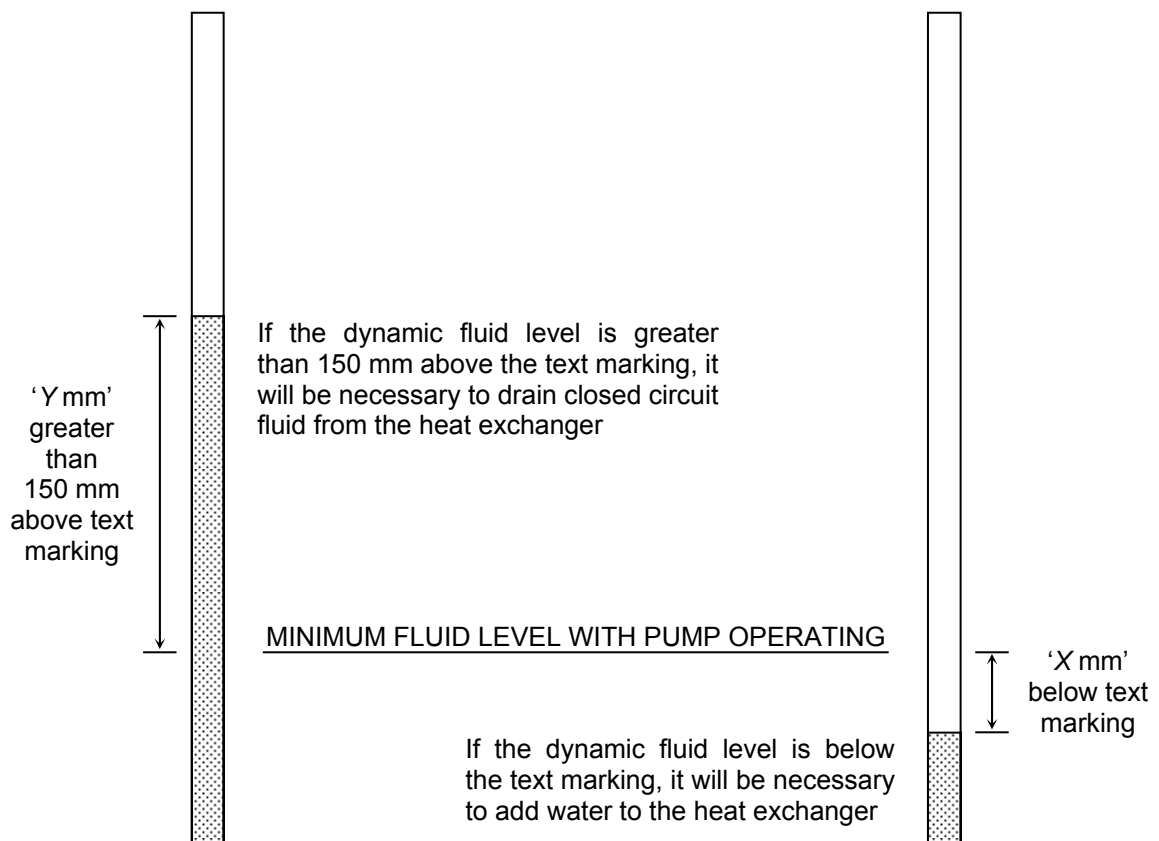

# COMMISSIONING

16. Determine the correct amount of water to be added to or closed circuit fluid to be drained from the heat exchanger if the dynamic level is either below the text marking “MINIMUM FLUID LEVEL WITH PUMP OPERATING” or more than 150 mm above this mark.

Each 100 mm of fluid level height is equivalent to three (3) litres of closed circuit fluid.

20 mm	0.6 litres	80 mm	2.4 litres	140 mm	4.2 litres
40 mm	1.2 litres	100 mm	3.0 litres	160 mm	4.8 litres
60 mm	1.8 litres	120 mm	3.6 litres	180 mm	5.4 litres

- Mark the required closed circuit fluid level to be obtained on the side of the solar storage tank with a non permanent marker beside the clear hose, in relation to the static level marked on the side of the solar storage tank during step 7.

Eg: If the dynamic level is 30 mm below the text marking, then place a mark 30 mm above the static level marked on the side of the solar storage tank in step 7. It would be necessary to add one litre of water to the heat exchanger.

Eg: If the dynamic fluid level is 180 mm above the text marking, then place a mark at least 30 mm, but no more than 180 mm, below the static level marked on the side of the solar storage tank. It would be necessary to drain between one litre and five litres of closed circuit fluid from the heat exchanger.

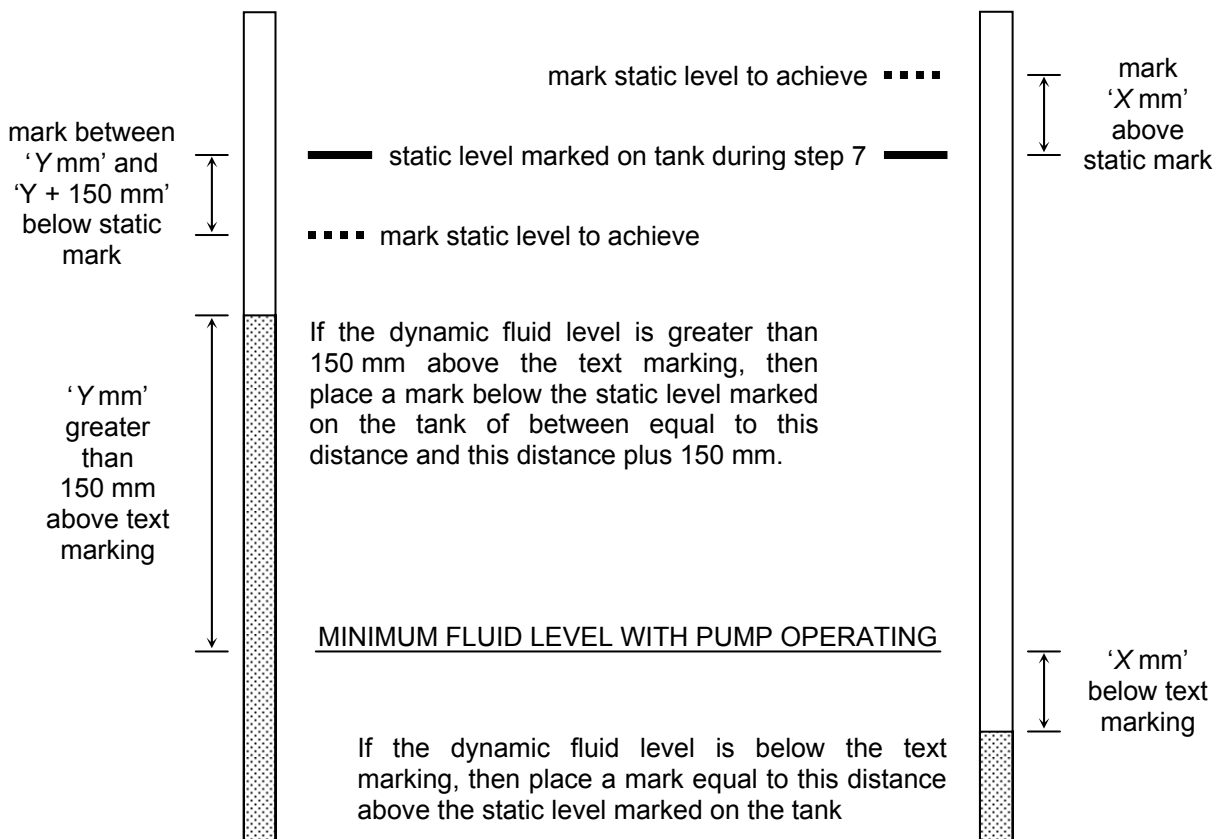

# COMMISSIONING

17. Add water to top up the level of the closed circuit fluid in the heat exchanger if required.

To add water to the closed circuit fluid:

- If not already removed, disconnect the drain line and remove the spring clip from the solar circuit relief valve at the top of the solar storage tank and remove the valve ([refer to step 5](#)).

**⚠ Warning:** The solar circuit may be under pressure. Take care when removing the solar circuit relief valve, as a sudden discharge of pressurised hot air may be experienced. This discharge will create a sharp sound of air being released.

- Place a funnel in the relief valve fitting.
- Add water slowly through the funnel until the level of fluid in the hose is at the desired level as marked on the solar storage tank.

**Note:** It may be necessary to undo the compression nut on the solar hot pipe at the top of the solar storage tank and loosen the pipe work from the fitting to assist the flow of water into the closed circuit through the funnel.

- Remove the funnel from the relief valve fitting.
- Position the solar hot pipe correctly in its fitting and tighten the compression nut if this has been loosened.

18. Drain closed circuit fluid from the heat exchanger if required.

To drain closed circuit fluid:

- If not already removed, disconnect the drain line and remove the spring clip from the solar circuit relief valve at the top of the solar storage tank and remove the valve ([refer to step 5](#)).

**⚠ Warning:** The solar circuit may be under pressure. Take care when removing the solar circuit relief valve, as a sudden discharge of pressurised hot air may be experienced. This discharge will create a sharp sound of air being released.

- Place the end of the solar fluid hose into a graduated volumetric container and drain closed circuit fluid until the level of fluid in the hose is at the desired level as marked on the solar storage tank.

It may be necessary to drain off the closed circuit fluid in small amounts, raising the hose back to the top of the solar storage tank and noting the level of the closed circuit fluid in the clear hose each time, so as not to drain below the desired level.

**Note:** The closed circuit fluid contains food grade additives (rust inhibitor, anti-freeze agent, colour) and is harmless to the environment. However, it is good practice to recover any excess fluid and remove from site.

- Re-affix the hose to the same location on the side of the solar storage tank.

19. If water has been added to or closed circuit fluid has been drained from the heat exchanger, recommence this procedure from [step 9](#).

# COMMISSIONING

## Pressure Testing the Solar Circuit

20. Close the heat exchanger drain valve.
21. Refit the solar circuit relief valve, orientating the valve outlet to the rear of the solar storage tank. Secure with the spring clip. Reconnect the drain pipe to the valve.
22. Switch on the electrical supply at the power outlet to the solar storage tank.

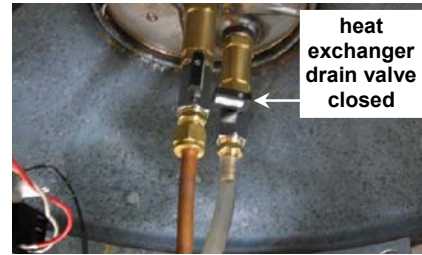

The pump will activate and commence pumping fluid around the solar circuit.

**Note:** The level of the closed circuit fluid in the clear hose will not change, as the heat exchanger drain valve has been closed.

Allow the pump to operate for three (3) minutes (one and two collector systems) or for five (5) minutes (3 collector system) to allow the solar circuit to stabilise and fill with closed circuit fluid.

**Note:** The solar pump will operate for one hour with the hot sensor lead disconnected, before automatically turning itself off. Refer to [step 24](#).

23. Check the solar pipe work and collector unions for leaks whilst the pump is operating and the solar circuit is at its working pressure. It is important to check all of the solar circuit pipe work, including in the roof space and on the roof.
24. If the procedure to check the solar pipe work for leaks is not complete before the pump has automatically turned off, then:
  - switch off the electrical supply at the power outlet to the solar storage tank.
  - wait ten (10) minutes for the operating system to reset to its commissioning sequence, otherwise the pump will not operate when the power supply is switched on.
  - recommence this procedure from [step 22](#).
25. Switch off the electrical supply at the power outlet to the solar storage tank.

The pump will deactivate.

The closed circuit fluid will drain back down to the heat exchanger.

26. Rectify any leaks in the solar pipe work and collector unions.

If brazing is required to fix any leaks, then it is necessary to remove the solar circuit relief valve ([refer to step 5](#)).

**⚠ Warning:** The solar circuit may be under pressure. Take care when removing the solar circuit relief valve, as a sudden discharge of pressurised hot air may be experienced. This discharge will create a sharp sound of air being released.

27. If minor leaks have been rectified, recommence this procedure from [step 22](#). If a major leak has been rectified, recommence this procedure from [step 5](#).

# COMMISSIONING

## Remove Closed Circuit Fluid Level Hose

28. Remove the clear hose from the solar storage tank when satisfied the commissioning procedure is complete. To remove the hose:

- Ensure the heat exchanger drain valve is closed.
- Remove the hose from the side of the storage tank and place the end into a container to collect the closed circuit fluid remaining in the hose.
- Replace the plug into the free end of the hose and lay the hose flat on the ground.
- Loosen the hose clamp, if fitted, and carefully remove the hose and hose clamp from the heat exchanger drain valve fitting, ensuring there is no spillage of the closed circuit fluid.

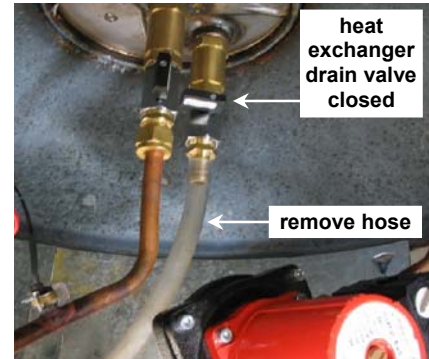

Clean up any spillage of closed circuit fluid.

- Place the open end of the hose into the container and recover the remainder of the closed circuit fluid from the hose.

**Note:** The closed circuit fluid contains food grade additives (rust inhibitor, anti-freeze agent, colour) and is harmless to the environment. However, it is good practice to recover any excess closed circuit fluid and remove from site.

## Completing the Commissioning of the Solar Circuit

29. Reconnect the hot sensor lead to the connecting plug located on the tab in the upper front cover opening.

It is important to reconnect the hot sensor lead, otherwise when the electrical supply is switched on, the solar pump will deactivate after one hour and the solar control unit will then enter a fault mode, will not operate and no solar gain will be achieved.

30. Replace the lower and upper front covers of the solar storage tank and the pipe cover to the underneath of the gas booster.



31. Clean off the marks made on the side of the solar storage tank.

32. Remove the covers from the solar collectors.

33. Switch on the electrical supply at the power outlet to the solar storage tank.

# COMMISSIONING

## DIAGNOSTIC FEATURES OF THE SOLAR CONTROLLER

The solar storage tank incorporates an electronic solar control module. This is located inside of the lower front cover and houses both a green and a red LED. The LEDs emit either a constant glow or a series of flashes with a 2 second interval between flashes. The green LED indicates the current operational mode of the solar water heater and the red LED indicates a fault mode. To view the status of the LEDs, it is necessary to remove the lower front cover.

**⚠ Warning:** The removal of the lower front cover will expose 240 V wiring. It must only be removed by an authorised or service person.

The modes are:

<b>Flashes</b>	<b>Operational Modes</b>
Solid green (remains on)	Standby mode
1 x green	Flooding solar circuit
2 x green	Checking solar contribution
3 x green	Pump flow control
4 x green	Pump flow established
5 x green	Tank at maximum temperature

<b>Flashes</b>	<b>Fault Modes</b>
1 x red	Hot sensor in collector – open circuit
2 x red	Hot sensor in collector – short circuit
3 x red	Cold sensor – open or short circuit
4 x red	Top three tank thermistors – open or short circuit

# COMMISSIONING

## GAS INLET PRESSURE

**IMPORTANT - CHECK** the gas supply pressure at the inlet to the water heater with the water heater and all other gas burning appliances in the premises operating (burners alight). The minimum gas supply pressure is:

Natural Gas	1.13 kPa	Propane	2.75 kPa
-------------	----------	---------	----------

If this minimum cannot be achieved, it may indicate the meter or the gas line to the water heater is undersized. It is important to ensure that an adequate gas supply pressure is available to the water heater when other gas burning appliances, on the same gas supply, are operating.

It is necessary to remove the pipe cover from underneath the gas booster, by undoing the retaining screws, in order to test the gas pressure at the inlet of the gas booster. Refit the pipe cover at the completion of the installation.

## BURNER GAS PRESSURE

It is necessary to check the burner gas pressure at both the minimum and maximum operational settings. It is necessary to have the electrical supply to the water heater switched on, the hot water must be flowing and the burners on to check and if necessary adjust the operational gas pressures.

**⚠ Warning:** The removal of the front cover will expose 240 volt wiring. Take care not to touch wiring terminals.

- Ensure the burners are not operating. Close any hot taps and turn off the gas supply at the gas isolation valve.
- Remove the screws holding the front panel to the jacket.
- Gently disengage the front panel and pull forward to remove from the water heater.
- Locate the burner pressure test point on the main burner manifold and connect a manometer.
- Turn on the gas supply at the gas isolation valve.



# COMMISSIONING

## Minimum test point gas pressure

Refer to the rating label on the water heater for the minimum test point gas pressure.

1. Open a hot tap slowly until the burners ignite.
2. Press and hold down the MIN button ("1L" is shown on the LED display), and observe the reading on the manometer.
3. Release the MIN button. If the manometer reading observed in Step 2 agrees with the rating label, no further adjustment is required.
4. To adjust, press and hold down the adjuster button ("LH" is shown on the LED display).

**Note:** The adjuster button must be held down continuously through steps 4 to 6.

5. Press the MIN button and observe the reading on the manometer.

**Note:** While the MIN button is pressed, the gas pressure will at first increase then decrease, cycling between an upper gas pressure limit (39 on LED display) and a lower gas pressure limit (01 on LED display).

6. Release the MIN button when the reading on the manometer agrees with the rating label.
7. Release the adjuster button.

### Notes:

- If the burners extinguish and / or an error code starts to flash on the display, release the MIN and adjuster buttons, close the hot tap, clear the error code, turn on the water heater and recommence the procedure from Step 1.
- If the adjuster button is released before Step 6, clear any error code (if displayed) and recommence the procedure from Step 1.
- To clear an error code, refer to "[Error Codes](#)" on page 16.

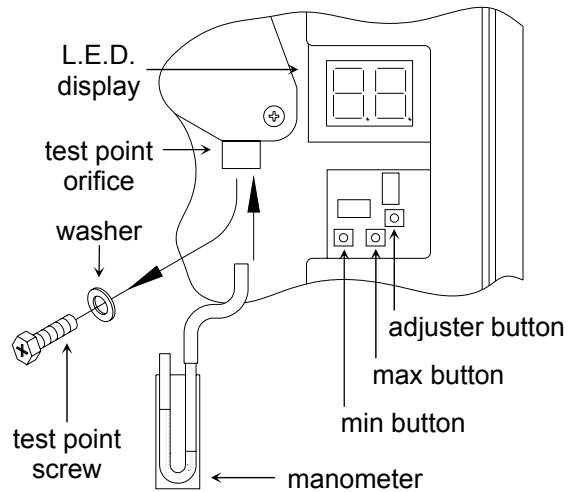

# COMMISSIONING

## Maximum test point gas pressure

Refer to the rating label on the water heater for the maximum test point gas pressure.

Follow Steps 1 to 7 of the “Minimum test point gas pressure” procedure, but open the hot tap fully and use the MAX button instead of the MIN button.

**Note:** In Step 2, “3H” or “4H” will be shown on the LED display, depending on the model of the water heater.

After setting the minimum and maximum test point gas pressures:

- Close the hot tap.
- Remove the manometer and refit and tighten the test point screw.
- Open a hot tap again so the burners ignite.
- Test for gas leaks.
- Refit the front panel and screws to the water heater.
- Close the hot tap.

## TO TURN OFF THE WATER HEATER

If it is necessary to turn off the water heater on completion of the installation, such as on a building site or where the premises is vacant, then:

- Switch off the electrical supply at the power outlet to the water heater (refer to note below).
- Close the gas isolation valve at the inlet to the water heater.
- Close the cold water isolation valve at the inlet to the water heater.
- Drain the gas booster if there is a risk of freezing conditions occurring (refer to [“Draining The Water Heater”](#) on page 51).

**Note:** The frost protection system of the gas booster will be rendered inoperable if electrical power is not available at the water heater. Damage caused by freezing due to the unavailability of power at the water heater is not covered by warranty (refer to [“Warranty Exclusions”](#) on page 53). If the power has been switched off to the water heater and there is a risk of freezing, then it is necessary to drain the gas booster (refer to [“Draining the Water Heater”](#) on page 51).

## DRAINING THE WATER HEATER

To drain the water heater:

### Gas Booster Water Heater

- Turn off the water heater (refer to [“To Turn Off The Water Heater”](#) on page 50).
- Open a hot tap (preferably the shower outlet).
- Unscrew the two drain plugs, one each at the cold water inlet and hot water outlet, on the underside of the gas booster.

Water will drain from the gas booster.

- When water stops flowing from the gas booster, close the hot tap.

**Note:** It is recommended not to screw the drain plugs back in, until the water heater is to be turned on again.

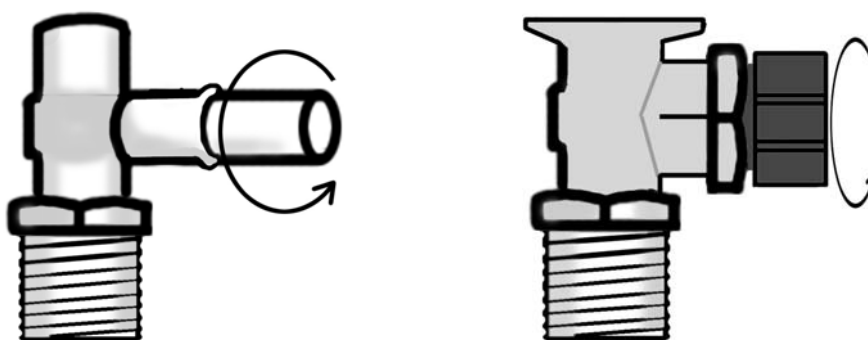

### Solar Storage Tank

- Turn off the water heater (refer to [“To Turn Off The Water Heater”](#) on page 50).
- Close all hot water taps.
- Operate the relief valve release lever - do not let the lever snap back or you will damage the valve seat.

Operating the lever will release the pressure in the water heater.

- Undo the union at the cold water inlet to the solar storage tank and attach a hose to the water heater side of the union.

Let the other end of the hose go to a drain.

- Operate the relief valve again.

This will let air into the water heater and allow the water to drain through the hose.

# WATER SUPPLIES

Your water heater is manufactured to suit the water conditions of most Australian metropolitan supplies. However, there are some known water supplies which can have detrimental effects on the water heater and its operation and/or life expectancy. If you are unsure of your water quality, you can obtain information from your local water supply authority. The water heater should only be connected to a potable water supply.

## ANODE

By using the correct colour coded anode this water heater can be used in areas where the total dissolved solids (TDS) content in the water is up to 2500 mg/L. In areas where the TDS exceeds 600 mg/L it is possible the black anode, which is the standard anode fitted to the water heater, may be excessively active. To alleviate this, the black anode should be replaced with one colour coded blue. Where the TDS of the water is less than 40 mg/L, such as when the water has been deionised or is from an alpine supply, a high potential anode, colour coded green, should be used. The changing of anodes must be carried out by a plumber or authorised service person.

## CAUTION

If your water supply has a TDS greater than 600 mg/L and the anode has not been changed to a blue one, there is the possibility hydrogen gas could accumulate in the top of the water heater during long periods of no use. In areas where this is likely to occur, the installer should instruct the householder on how to dissipate the gas safely.

If, under these conditions, the water heater has not been used for two or more weeks the following procedure should be carried out before using any electrical appliances (automatic washing machines and dishwashers) which are connected to the hot water supply.

The hydrogen, which is highly flammable, should be vented safely by opening a hot tap and allowing the water to flow. There should be no smoking or naked flame near the tap whilst it is turned on. Any hydrogen gas will be dissipated. This is indicated by an unusual spurting of the water from the tap. Once the water runs freely again, any hydrogen in the system will have been released.

## SATURATION INDEX

The saturation index is used as a measure of the water's corrosive or scaling properties. In a corrosive water supply, the water can attack copper parts and cause them to fail. Where the saturation index is less than  $-1.0$ , the water is corrosive.

In a scaling water supply calcium carbonate is deposited out of the water onto any hot metallic surface. Where the saturation index exceeds  $+0.40$ , the water is scaling and an expansion control valve\* must be fitted on the cold water line after the non-return valve.

\* Refer to the [cold water connection detail on page 29](#).

**WATER HEATERS NOT INSTALLED IN ACCORDANCE WITH THE ABOVE ADVICE WILL NOT BE COVERED BY THE WARRANTY.**

# SOLAHART STREAMLINE, SYNERGY, GAS BOOSTER SOLAR WATER HEATER WARRANTY – AUSTRALIA ONLY

## WARRANTY CONDITIONS

1. This warranty is applicable only to water heaters manufactured from 1<sup>st</sup> July 2006.
2. The water heater must be installed in accordance with the Solahart water heater installation instructions, supplied with the water heater, and in accordance with all relevant statutory and local requirements of the State in which the water heater is installed.
3. Where a failed component or water heater is replaced under warranty, the balance of the original warranty period will remain effective. The replaced part or water heater does not carry a new warranty.
4. Where the water heater is installed outside the boundaries of a metropolitan area as defined by Solahart or further than 30 km from a regional Solahart Dealer from whom the water heater was purchased, the cost of transport, insurance and travelling costs between the nearest Solahart Dealer's premises and the installed site shall be the owner's responsibility.
5. Where the water heater is installed in a position that does not allow safe, ready access, the cost of accessing the site safely, including the cost of additional materials handling and / or safety equipment, shall be the owner's responsibility.
6. The warranty only applies to the water heater and original or genuine (company) component replacement parts and therefore does not cover any plumbing or electrical parts supplied by the installer and not an integral part of the water heater, e.g. pressure limiting valve; isolation valves; non-return valves; electrical switches; pumps or fuse.
7. The water heater must be sized to supply the hot water demand in accordance with the guidelines in the Solahart water heater literature.

## WARRANTY EXCLUSIONS

1. REPAIR AND REPLACEMENT WORK WILL BE CARRIED OUT AS SET OUT IN THE SOLAHART WATER HEATER WARRANTY, HOWEVER THE FOLLOWING EXCLUSIONS MAY CAUSE THE WATER HEATER WARRANTY TO BECOME VOID AND MAY INCUR A SERVICE CHARGE AND / OR COST OF PARTS.
  - a) Accidental damage to the water heater or any component, including: Acts of God; failure due to misuse; incorrect installation; attempts to repair the water heater other than by the Solahart Dealer.
  - b) Where it is found there is nothing wrong with the water heater; where the complaint is related to excessive discharge from the temperature and / or pressure relief valve due to high water pressure; where the complaint is related to insufficient or incorrect fall in the pipe work preventing complete drain back of the closed circuit fluid of a Streamline closed circuit system; where there is no flow of hot water due to faulty plumbing; where water leaks are related to plumbing and not the water heater or water heater components; where there is a failure of gas, electricity or water supplies; where the supply of gas, electricity or water does not comply with relevant codes or acts.
  - c) Where the water heater or water heater component has failed directly or indirectly as a result of: excessive water pressure; excessive temperature and / or thermal input; blocked overflow / vent drain; corrosive atmosphere; non Solahart approved or incorrectly mixed closed circuit fluid being used; incorrect or insufficient filling of the closed circuit system with the closed circuit fluid; ice formation in the pipe work to or from the water heater.
  - d) Where the solar water heater or solar water heater component has failed directly or indirectly as a result of ice formation in the water ways of: a Streamline open circuit system; a Streamline closed circuit system where the system has not been installed in accordance with the water heater installation instructions; a Streamline closed circuit system due to non Solahart approved or incorrectly mixed closed circuit fluid being used; a Streamline closed circuit system where there is insufficient or incorrect fall in the pipe work preventing complete drain back of the closed circuit fluid.
  - e) Where the electronic instantaneous gas booster water heater or electronic instantaneous gas booster water heater component has failed directly or indirectly as a result of ice formation in the water ways of a water heater: where the water heater has not been installed in accordance with the water heater installation instructions; where the electricity has been switched off or has failed and the water heater has not been drained in accordance with the instructions; due to an ambient temperature below -20°C (including wind chill factor).
  - f) Where the water heater is located in a position that does not comply with the Solahart water heater installation instructions or relevant statutory requirements, causing the need for major dismantling or removal of cupboards, doors or walls, or use of special equipment to bring the water heater to floor or ground level or to a serviceable position.
  - g) Repair and / or replacement of the water heater due to scale formation in the waterways or the effects of either corrosive water or water with a high chloride or low pH level when the water heater has been connected to a scaling or corrosive water supply or a water supply with a high chloride or low pH level as outlined in the Owner's Guide and Installation Instructions booklet.
  - h) Breakage of collector glass for any reason including hail damage. (We suggest that the collector glass be covered by your home insurance policy).
2. SUBJECT TO ANY STATUTORY PROVISIONS TO THE CONTRARY, THIS WARRANTY EXCLUDES ANY AND ALL CLAIMS FOR DAMAGE TO FURNITURE, CARPETS, WALLS, FOUNDATIONS OR ANY OTHER CONSEQUENTIAL LOSS EITHER DIRECTLY OR INDIRECTLY DUE TO LEAKAGE FROM THE WATER HEATER, OR DUE TO LEAKAGE FROM FITTINGS AND/OR PIPE WORK OF METAL, PLASTIC OR OTHER MATERIALS CAUSED BY WATER TEMPERATURE, WORKMANSHIP OR OTHER MODES OF FAILURE.

# SOLAHART STREAMLINE, SYNERGY, GAS BOOSTER SOLAR WATER HEATER WARRANTY – AUSTRALIA ONLY

## WARRANTY

Solahart\* will:

- a) Repair or, if necessary replace any Solahart water heater; or
- b) Replace any component (or, if necessary, arrange the installation of a new water heater), which falls within the Warranty Periods specified below, subject to the warranty conditions and exclusions.

Installation	Model	Period	Warranty
<b>All Components (from date of installation)</b>			
All installations	All models	Year 1	New component, solar collector or water heater (at Solahart's sole discretion), free of charge, including labour.**
<b>Sealed System *** (from date of installation)</b>			
Water heater installed in a "single-family domestic dwelling"	Synergy	Year 2	New sealed system component, free of charge, including labour.**
<b>Cylinder (from date of installation)</b>			
Water heater installed in a "single-family domestic dwelling"	Streamline, Streamline Closed Circuit, Synergy	Years 2 & 3	New water heater, free of charge, including labour.**
		Years 4 & 5	
Water heater installed in any other than a "single-family domestic dwelling"	Streamline, Streamline Closed Circuit, Synergy	Years 2 & 3	New water heater, free of charge, with installation and labour costs being the responsibility of the owner.
<b>Heat Exchanger Electronic Instantaneous Gas Booster (from date of installation)</b>			
Water heater installed in a "single-family domestic dwelling"	Streamline Closed Circuit	Years 2 & 3	New heat exchanger, free of charge, including labour.**
		Years 4 & 5	New heat exchanger, free of charge, with installation and labour costs being the responsibility of the owner.
<b>Solar Collector (from date of installation)</b>			
All installations	L J KF	Years 2 to 5	New solar collector, free of charge, with installation and labour costs being the responsibility of the owner.

## Notes:

\* Solahart is the supplier of Solahart electronic instantaneous solar gas booster water heaters, manufactured by Paloma Industries, a world leader in water heater technology and manufacture.

\*\* Refer to items 4 and 5 of warranty conditions.

\*\*\* The Sealed System includes components that carry refrigerant only, e.g. Compressor, Condenser, TX Valve, Receiver/Drier, Evaporator and associated pipe work.

Solahart reserves the right to transfer fully functional components from the defective water heater to the replacement water heater if required. The term "water heater" used in the Warranty, Warranty Conditions and Warranty Exclusions means the Solahart supplied water heater(s), solar storage tank(s), solar collector(s), kit(s) and components.

In addition to this warranty, the Trade Practices Act 1974 and similar laws in each state and territory provide the owner under certain circumstances with certain minimum statutory rights in relation to your Solahart water heater. This warranty must be read subject to that legislation and nothing in this warranty has the effect of excluding, restricting or modifying those rights.

**SOLAHART INDUSTRIES PTY LTD**  
 ABN 45 064 945 848  
 www.solahart.com.au

**FOR SERVICE TELEPHONE**  
**Your Nearest Solahart Dealer or**  
**1800 638 011 AUSTRALIA**  
 or refer local Yellow Pages

Note: Every care has been taken to ensure accuracy in preparation of this publication. No liability can be accepted for any consequences, which may arise as a result of its application.

## SOLAHART INSTALLATION AND WARRANTY REPORT

**Dear Customer – To register your warranty please ensure the following information is correct then sign and return to our Solahart Industries Pty Ltd freepost address:**

Solahart Industries Pty Ltd.  
Reply Paid Perth 354,  
Welshpool, Western Australia 6106

### WARRANTY

Details and conditions of warranty are in the [“Water Heater Warranty”](#) section of this manual.

**Please complete all details below**

<b>Owner's Name</b>			
<b>Installation Address</b>			
<b>Suburb</b>		<b>State</b>	
<b>Country</b>		<b>Postcode</b>	
<b>Telephone</b>	(H)		(W)
<b>Solahart Dealership</b>		<b>Consultant</b>	

<b>Installer's Name</b>				<b>Installation Date</b>		
<b>Type of Installation</b> (please circle)	New	Solar to Solar	Tank Replacement	Other		
<b>Work Delivery Details</b>						

<b>System Model No</b>				<b>System Type</b>		
<b>Tank Model No</b>				<b>Tank Serial No</b>		
<b>Collector Model No</b>				<b>No of Collectors</b>		
<b>Collector Serial No's</b>	1)	2)	3)	4)		
<b>Booster Type</b> (please circle)	Electric continuous	Off Peak 1 (night)	Off Peak 2 (night & day)	In-Tank Gas Booster	In-Line Booster	Solar Preheat only
<b>Booster Control</b> (please circle)	None		Timer	Manual Switch		One Shot Control
<b>In-Line Booster</b> (if installed)	<b>Model No</b>			<b>Serial No</b>		
<b>Service's Due</b>	1)	2)	3)	4)		

If replacing a water heater, please give details

<b>Brand</b>		<b>Model No</b>		Electric	Gas
<b>If a Solahart unit</b>	Tank Serial No			Date of manufacture	
<b>Collector Serial No's</b>	1)	2)	3)	4)	

<b>Comments</b>					

<b>Installer Certification</b> – I certify this installation has been installed and tested in accordance with Solahart Industries Pty Ltd specifications					
<b>Signature:</b>	Installer		Customer		
<b>Date</b>					

White Copy: Head Office

Yellow Copy: Dealer

Blue Copy: Sales Office

Green Copy: Manual

# SOLAHART OFFICES

## Corporate Headquarters

112 Pilbara St  
Welshpool  
Western Australia 6106

Postal Address:  
PO Box 95  
State Parcel Centre  
Welshpool WA 6986

Telephone International:  
**+ 61 8 9351 4600**

Facsimile International:  
**+ 61 8 9351 4698**

Email:  
**solahart@solahart.com.au**

Internet:  
**www.solahart.com.au**

## Australian Offices

### Western Australia

Phone: 08 9351 4600  
Facsimile: 08 9351 4635

### New South Wales

Phone: 02 9684 9333  
Facsimile: 02 9684 9187

### Queensland

Phone: 07 3255 5185  
Facsimile: 07 3255 5189

### South Australia

Phone: 08 8262 7825  
Facsimile: 08 8359 6004

### Victoria / Tasmania

Phone: 03 9212 8950  
Facsimile: 03 9212 8940

### Northern Territory

Phone: 08 8947 0274  
Facsimile: 08 8947 1944

## International Offices

### Europe

Phone International: + 31 492 579 696  
Facsimile International: + 31 492 579 694

### Rest of the World

Phone International: + 61 8 9351 4600  
Facsimile International: + 61 8 9351 4698

### USA

Phone International: + 1 334 260 1586  
Facsimile International: + 1 334 260 1514



## Free Manuals Download Website

<http://myh66.com>

<http://usermanuals.us>

<http://www.somanuals.com>

<http://www.4manuals.cc>

<http://www.manual-lib.com>

<http://www.404manual.com>

<http://www.luxmanual.com>

<http://aubethermostatmanual.com>

Golf course search by state

<http://golfingnear.com>

Email search by domain

<http://emailbydomain.com>

Auto manuals search

<http://auto.somanuals.com>

TV manuals search

<http://tv.somanuals.com>