

Use & Care Manual

With Installation Instructions for the Installer

Indoor and Outdoor Gas

Tankless Water Heater

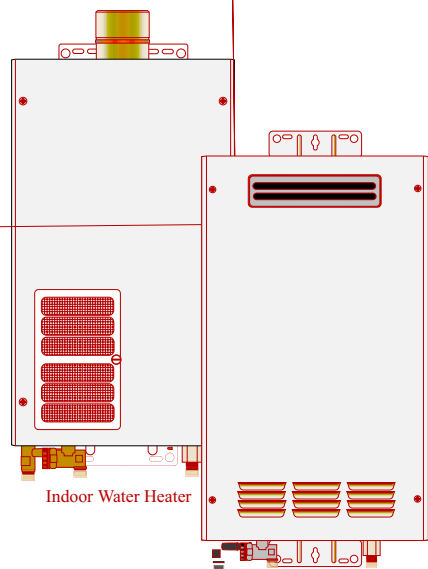

Indoor Water Heater

Outdoor Water Heater

Paloma:	Rheem:	Ruud:
PH-28 RIFS (N,P)	RTG-74PV(N,P)	RUTG-74PV(N,P)
PH-28 ROF (N,P)	RTG-74X(N,P)	RUTG-74X(N,P)
PH-28 CIFS (N,P)		
PH-28 COF (N,P)	Richmond:	Rheem/Ruud
Paloma:	RMTG-74PV(N,P)	GT-199PV(NP)
PTG-74PV(N,P)	RMTG-74X(N,P)	
PTG-74X(N,P)		

Warning: This water heater is not suitable for use in manufactured (mobile) homes!

The purpose of this manual is twofold: one, to provide the installer with the basic directions and recommendations for the proper installation and adjustment of the water heater; and two, to the owner-operator, to explain the features, operation, safety precautions, maintenance and troubleshooting of the water heater. This manual also includes a parts list.

It is very important that all persons who are expected to install, operate or adjust this water heater read the instructions carefully so they may understand how to perform these operations. If you don't understand these instructions or any terms within it, seek professional assistance.

Any questions regarding the operation, maintenance, service or warranty of this water heater should be directed to the seller from whom it was purchased. If additional information is required, refer to the section on If You Need Service.

Do not destroy this manual. Please read carefully and keep in a safe place for future reference.



Recognize this symbol as an indication of Important Safety Information!



California Proposition 65 Warning: This product contains chemicals known to the State of California to cause cancer, birth defects or other reproductive harm.



WARNING: If the information in these instructions is not followed exactly, a fire or explosion may result, causing property damage, personal injury or death.

FOR YOUR SAFETY!

— Do not store or use gasoline or other flammable vapors or liquids or other combustible materials in the vicinity of this or any other appliance. To do so may result in an explosion or fire.

WHAT TO DO IF YOU SMELL GAS

- Do not try to light any appliance.
- Do not touch any electrical switch; do not use any phone in your building.
- Immediately call your gas supplier from a neighbor's phone. Follow the gas supplier's instructions.

- If you cannot reach your gas supplier, call the fire department.
 - Do not return to your home until authorized by the gas supplier or fire department.
- Improper installation, adjustment, alteration, service or maintenance can cause property damage, personal injury or death. Refer to this manual. Installation and service must be performed by a qualified installer, service agency or the gas supplier.



Safety Information

Safety Precautions 3-6
LP Gas Models 5

Installation Instructions

Location, Outdoor 7
Location, Indoor 8, 9
Venting 10-15
Water Connections 16-18
Gas Supply 19
High Altitude 19
Remote Control 20, 21
Electrical Connection 22
Typical Installation 23
Pipe Insulation 24
Installation Checklist 25

Operating Instructions

Lighting Instructions 26
Water Temperature 27, 28

Care and Cleaning

Maintenance 29
Housekeeping 29, 30
Vent Inspection 30
Burner Inspection 30
Extended Shut-Down 30
Draining 31
Freeze Protection 31

Troubleshooting Tips

Before You Call
For Service 32, 33

Customer Service

Parts List 34
If You Need Service 36

Qualified Installers Only!

Dip Switch Adjustment 35



FOR YOUR RECORDS

Write the model and serial numbers here:

You can find them on a label on the appliance.

Staple sales slip or cancelled check here.

Proof of the original purchase date is needed to obtain service under the warranty.



READ THIS MANUAL

Inside you will find many helpful hints on how to use and maintain your water heater properly. A little preventive care on your part can save you time and money over the life of your water heater.

You'll find many answers to common problems in the Troubleshooting Guide. If you review the chart of Troubleshooting Tips first, you may not need to call for service.



READ THE SAFETY INFORMATION

Your safety and the safety of others are very important. There are many important safety messages in this manual and on your appliance. Always read and obey all safety messages.



This is the safety alert symbol. Recognize this symbol as an indication of Important Safety Information! This symbol alerts you to potential hazards that can kill or hurt you and others.

All safety messages will follow the safety alert symbol and either the word "DANGER", "WARNING", "CAUTION" or "NOTICE".

These words mean:

▲ DANGER

An imminently hazardous situation that will result in death or serious injury.

▲ WARNING

A potentially hazardous situation that could result in death or serious injury and/or damage to property.

▲ CAUTION

A potentially hazardous situation that may result in minor or moderate injury.

Notice:

Attention is called to observe a specified procedure or maintain a specific condition.

IMPORTANT SAFETY INFORMATION. READ ALL INSTRUCTIONS BEFORE USING.

Be sure to read and understand the entire Use and Care Manual before attempting to install or operate this water heater. It may save you time and money. Pay particular attention to the Safety Instructions. Failure to follow these warnings could result in serious bodily injury or death. Should you have problems understanding the instructions in this manual, or have any questions, STOP, and get help from a qualified service technician, or the local gas utility.



! DANGER!

INSTALL AND PROPERLY VENT THE WATER HEATER...

Failure to install and properly vent the water heater to the outdoors as outlined in the Venting Section of the Installation Instructions in this manual can result in unsafe operation of the water heater. To avoid the risk of fire, explosion or asphyxiation from carbon monoxide, never operate this water heater unless it is properly vented and has an adequate air supply for proper operation.

Be sure to inspect the vent outlet on the OUTDOOR water heater, or the vent terminal and the vent system on the INDOOR water heater for proper installation at initial start-up; and at least annually thereafter. Refer to the Care and Cleaning section of this manual for more information regarding vent system inspection.



! WARNING!

Gasoline, as well as other flammable materials and liquids (adhesives, solvents, paint thinners etc.), and the vapors they produce are extremely dangerous. DO NOT handle, use or store gasoline or other flammable or combustible materials anywhere near or in the vicinity of a water heater or any other appliance. Be sure to read and follow the labels on the water heater, as well as the warnings printed in this manual. Failure to do so can result in property damage, bodily injury or death.

! DANGER



<p>! Vapors from flammable liquids will explode and catch fire causing death or severe burns.</p> <p>Do not use or store flammable products such as gasoline, solvents or adhesives in the same room or area near the water heater.</p> <p>Keep flammable products:</p> <ol style="list-style-type: none">1. far away from heater,2. in approved containers,3. tightly closed and4. out of children's reach.	<p>Water heater has a main burner flame.</p> <p>The main burner flame:</p> <ol style="list-style-type: none">1. which can come on at any time and2. will ignite flammable vapors. <p>Vapors:</p> <ol style="list-style-type: none">1. cannot be seen,2. are heavier than air,3. go a long way on the floor and4. can be carried from other rooms to the main burner flame by air currents.
--	--

Installation:

Do not install water heater where flammable products will be stored or used unless the main burner flame is at least	18" above the floor. This will reduce, but not eliminate, the risk of vapors being ignited by the main burner flame.
--	--

Read and follow water heater warnings and instructions. If owners manual is missing, contact the retailer or manufacturer.

IMPORTANT SAFETY INFORMATION

READ ALL INSTRUCTIONS BEFORE USING.



⚠️ DANGER!

WATER TEMPERATURE SETTING

Safety and energy conservation are factors to be considered when selecting the water temperature setting of a water heater's remote control. Water temperatures above 125°F (52°C) can cause severe burns or death from scalding. Be sure to read and follow the warnings outlined on the label pictured below.

⚠️ DANGER

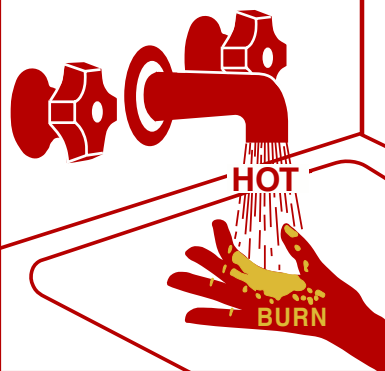

Water temperature over 125°F can cause severe burns instantly or death from scalds.
 Children, disabled and elderly are at highest risk of being scalded.
 See instruction manual before setting temperature at water heater.
 Feel water before bathing or showering.
 Temperature limiting valves are available, see manual.

Time/Temperature Relationship in Scalds

Water Temperature	Time To Produce a Serious Burn
120°F (49°C)	More than 5 minutes
125°F (52°C)	1½ to 2 minutes
130°F (54°C)	About 30 seconds
135°F (57°C)	About 10 seconds
140°F (60°C)	Less than 5 seconds
145°F (63°C)	Less than 3 seconds
150°F (66°C)	About 1½ seconds
155°F (68°C)	About 1 second

Table courtesy of Shriners Burn Institute

The chart shown above may be used as a guide in determining the proper water temperature for your home.

⚠️ DANGER: Households with small children, disabled or elderly persons may require a 120°F (49°C) or lower temperature setting to prevent contact with "HOT" water.

Maximum water temperature occurs while burner is on. To find water temperature being delivered, turn on a hot water faucet and place a thermometer in the water stream and read the thermometer. (See page 27 & 28 for more details.)

The temperature of the water at the outlet of the water heater can be regulated by setting the temperature on Remote Control. The remote control was set at 100°F (38°C) before it was shipped from the factory.

The diagram to the bottom left illustrates the Remote Control and how to adjust the water temperature.

Notice: The factory setting allows operating temperatures between 100°F (38°C) and 120°F (49°C). Temperatures of up to 140°F (60°C) for Light duty models and up to 180°F (82°C) for Heavy Duty models can be achieved with the MAIN (UMC-117) remote control and a dip switch adjustment. Only qualified service personnel should perform this adjustment. Only factory authorized remote control(s) should be used.

Notice: When this water heater is supplying general purpose hot water requirements for use by individuals, a thermostatically controlled mixing valve for reducing point of use water temperature is recommended to reduce the risk of scald injury. Contact a licensed plumber or the local plumbing authority for further information.

Notice:
Display shows °F only.

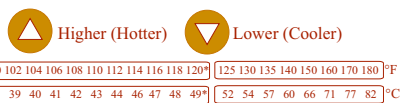
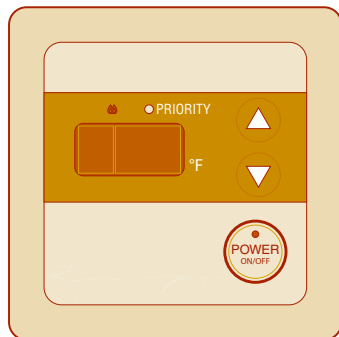

Notice: Only heavy duty water heaters can achieve temperatures up to 180°F (82°C).

* Temperatures above 120°F (49°C) can be achieved by adjusting the dip switch. See page 35 for dip switch adjustment.



! DANGER!

NATURAL GAS AND LIQUEFIED PETROLEUM MODELS

Both LP and natural gas have an odorant added to aid in detecting a gas leak. Some people may not physically be able to smell or recognize this odorant. If you are unsure or unfamiliar with the smell of LP or natural gas, ask the gas supplier. Other conditions, such as “odorant fade”, which causes the odorant to diminish in intensity, can also hide or camouflage a gas leak.

- Water heaters utilizing LP gas are different from natural gas models. A natural gas water heater will not function safely on LP gas and vice versa.
 - No attempt should ever be made to convert the water heater from natural gas to LP gas. To avoid possible equipment damage, personal injury or fire, do not connect the water heater to a fuel type not in accordance with the unit data plate; propane for propane units and natural gas for natural gas units. These units are not certified for any other fuel type.
 - LP appliances should not be installed below grade (for example, in a basement) if such installation is prohibited by federal, state and/or local laws, rules, regulations or customs.
 - Propane or LP gas must be used with great caution. It is heavier than air and will collect first in lower areas, making it hard to detect at nose level.
 - Before attempting to light the water heater, make sure to look and smell for gas leaks. Use a soapy solution to check all gas fittings and connections. Bubbling at a connection indicates a leak that must be corrected. When smelling to detect a gas leak, be sure to sniff near the floor also.
 - Gas detectors are recommended in LP and natural gas applications and their installation should be in accordance with the detector manufacturer’s recommendations and/or local laws, rules, regulations or customs.
 - It is recommended that more than one method, such as soapy solution, gas detectors, etc., be used to detect leaks in gas applications.
- Notice: If a gas leak is present or suspected:**
- ***Do not*** attempt to find the cause yourself.
 - ***Do not*** try to light any appliance.
 - ***Do not*** touch any electrical switch.
 - ***Do not*** use any phone in your building.
 - Leave the building immediately and make sure your family and pets leave also.
 - Leave the doors open for ventilation and contact the gas supplier, a qualified service agency or the fire department.
 - Stay away from the building until the service call has been made, the leak is corrected and a qualified agency has determined the area to be safe.

IMPORTANT SAFETY INFORMATION

READ ALL INSTRUCTIONS BEFORE USING.

WARNING!

For your safety, the information in this manual must be followed to minimize the risk of fire or explosion, electric shock, or to prevent property damage, personal injury or loss of life.



FOR INSTALLATIONS IN THE STATE OF CALIFORNIA

California Law requires that water heaters must be braced, anchored or strapped to resist falling or horizontal displacement due to earthquake motions. For water heaters up to 52 gallon capacity, a brochure with generic earthquake bracing instructions can be obtained from: Office of the State Architect, 1102 Q Street, Suite 5100, Sacramento, CA 95814 or you may call 916-445-8100 or ask a water heater dealer.

However, applicable local codes shall govern installation. For residential water heaters of a capacity greater than 52 gallons or tankless-style, consult the local building jurisdiction code for acceptable bracing procedures.



SAFETY PRECAUTIONS

Have the installer show you the location of the gas shut-off valve and how to shut it off if necessary. Turn off the manual shut-off valve if the water heater has been subjected to overheating, fire, flood, physical damage or if the gas supply fails to shut off.

- Read this manual entirely before installing or operating the water heater.
- Use this appliance only for its intended purpose as described in this Use and Care Manual.
- Be sure your appliance is properly installed in accordance with local codes and the provided installation instructions.
- Do not attempt to repair or replace any part of your water heater unless it is specifically recommended in this manual. All other servicing should be referred to a qualified technician.



READ AND FOLLOW THIS SAFETY INFORMATION CAREFULLY.

SAVE THESE INSTRUCTIONS

Installing the (OUTDOOR) water heater:

This water heater must be installed in accordance with these instructions, local codes, utility company requirements and/or in the absence of local codes, use the latest edition of the American National Standard/National Fuel Gas Code. A copy can be purchased from either the American Gas Association, 400 North Capitol Street Northwest, Washington, DC 20001 as ANSI standard Z223.1 or National Fire Protection Association, 1 Batterymarch Park, Quincy, MA 02269 as NFPA 54. In Canada, the latest edition of the CSA B149.1 Natural Gas and Propane Installation, and the Canadian Electrical Code, CSA C22.1 Part 1, in the absence of local codes.

Location of the OUTDOOR water heater

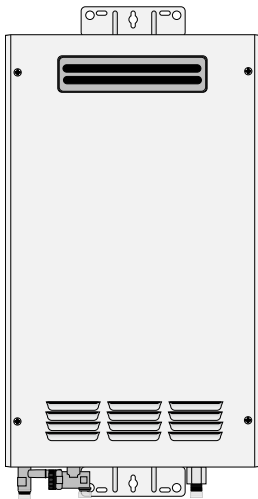

Outdoor Water Heater

The water heater shown on the left is for **OUTDOOR installation ONLY!**

This water heater is an outdoor model and must be mounted vertically. It must not be installed indoors or in a confined space.

The water heater should be installed close to the most frequently used outlet and its position chosen with safety and service in mind.

Make sure people (particular children, disabled, and elderly) will not touch the hot water outlet or the flue terminal. The flue terminal and air inlet must be clear of obstruction and shrubbery.

The water heater should not be located in an area where leakage of the heat exchanger or connections will result in damage to the area adjacent to it or to lower floors of the structure.

A gas fired water heater or any other appliance should not be installed in a space where liquids which give off flammable vapors are to be used or stored. Such liquids include gasoline, LP gas (butane or propane), paint or adhesives and their thinners, solvents or removers.

Because of natural air movement in a room or other enclosed space, flammable vapors can be carried some distance from where their liquids are being used or stored. The open flame of the water heater's main burner can ignite these vapors, causing an explosion or fire which may result in severe burns, death or property damage.

The water heater must be located so it is not subject to physical damage, for example, by moving vehicles, area flooding, etc.

- The water heater should be installed vertically with the water, gas and power connections on the underside pointing toward the ground.
- Failure to properly install the water heater outdoors as outlined in this manual can result in unsafe operation.
- Hot and cold water lines should be insulated to conserve water and energy.
- The water heater and water lines should be protected from exposure to freezing temperatures.
- **Do not** install water heater where subject to vibrations.
- **Do not** install the water heater in Recreational Vehicles, Mobile Homes, Boats and other Watercrafts.
- **Do not** install the water heater near vents for heating or cooling. A minimum of 4 feet should be maintained.
- Minimum clearance from combustible and noncombustible construction is 1/2" (1.3 cm) sides, 0" rear (with support bracket); 12" (30 cm) from the bottom; 12" (30 cm) from the front of the water heater; (24" [61 cm] from front recommended for servicing purposes). If the clearances stated on the Instruction/Warning Label, located on the front panel of the heater differ, install the water heater according to the clearances stated on the label.

▲ WARNING: Combustible construction refers to adjacent walls and ceilings and should not be confused with combustible or flammable products and materials. Combustible and/or flammable products and materials should never be stored in the vicinity of this or any gas appliance.

▲ CAUTION: Protect plastic, paint or other items sensitive to heat using non-combustible insulation if these are exposed to the flue exhaust even though they may be more than 24" (61 cm) away from the water heater.

Minimum Clearance from Combustible and Non-Combustible Construction.

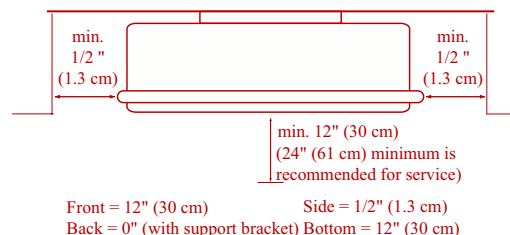

Top: Do not install this water heater under an overhang less than 36" (91 cm) from its top. The area under the overhang must be open on 3 sides.

Water heater :

Read carefully with these instructions, local codes, utility company requirements, and local regulations. Always use the latest edition of the American National Standards Institute (ANSI) standard Z223.1 or National Fire Protection Association (NFPA) standard 54. In Canada, the latest edition of the CSA Standard C22.1 Part 1, in the

DOOR Water Heater

The diagram on the left is for **DOOR ONLY!**

Water heater should not be located in a space where the heat exchanger could result in damage to the structure or lower floors of the building.

Water heater should not be avoided, it is required to have a suitable catch pan, and must be installed under the vent.

Restrict combustion

Water heater or any other appliance should not be installed in a space where flammable vapors are present. Such liquids include oil, kerosene, or propane, paint thinners, solvents

Water heater should not be installed in a room or area where flammable vapors can be present. The open flame of the burner can ignite these vapors, causing a fire which may result in death or property damage.

Water heater should not be located so it is not protected from flooding, etc.

Water heater should not be installed in a garage, it should be located so that the direct ignition source is no less than 18 inches from the garage floor.

Water heater will reduce the possibility of lighting flammable liquids which may be accidentally spilled.

Water heater should be installed as shown in the vent termination to

minimize vent length and the number of elbows required for venting.

- The water heater **should** be installed with the proper venting materials and termination suitable for **Category III** venting.
- A fire stop plate should be installed at every penetration of a floor or ceiling if the vent is not running in a fire rated shaft.
- Failure to install and properly vent the water heater to the outdoors as outlined in the Venting Section of this manual can result in unsafe operation.
- Long hot water lines should be insulated to conserve water and energy.
- The water heater and water lines should be protected from exposure to freezing temperatures.
- **Do not** install the water heater in bathrooms, bedrooms, any occupied rooms normally kept closed, or in outdoor areas.
- **Do not** install the water heater in small, poorly ventilated rooms, or in airtight rooms with air conditioning.
- **Do not** install water heater where subject to vibrations.
- **Do not** install the water heater in Recreational Vehicles, Mobile Homes, Boats and other Watercrafts.
- **Do not** install the water heater near vents for heating or cooling. A minimum of 4 feet (1.2 m) should be maintained.
- Minimum clearance from combustible and non-combustible construction is 1/2" (1.3 cm) sides, 0" rear (with support bracket); 12" (30 cm) from the bottom; 12" (30 cm) from the front of the water heater; and 12" (30 cm) from the top (24" [61 cm] from front and top is recommended for servicing purposes).
- Maintain a minimum clearance of 3" (8 cm) around the vent pipe to combustible or non-combustible construction, unless otherwise specified by vent manufacturer or installed in an enclosed space. If the clearances stated on the Instruction/Warning Label, maintain the front panel of the heater



Proper operation of the water heater requires air for combustion and ventilation. Provisions for combustion and ventilation air must comply with referenced codes and standards.

Combustion and Ventilation Air (Indoor Water Heater Only)

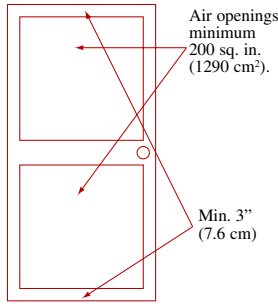

⚠ DANGER: OUTDOOR water heaters must not be installed indoors or in a confined space. Install outdoor water heaters outdoors only.

NOTICE: If the water heater is installed in an unconfined space within a building of conventional frame, masonry or metal construction, infiltration air is normally adequate for proper combustion and ventilation. If the water heater is installed in a confined space, provisions for combustion and ventilation air must be made.

A confined space is one having a volume of less than 50 cubic feet (1.4 m³) per 1000 Btuh (0.3 kw) of the aggregate input of all appliances within that space.

The air must be supplied through two permanent openings of equal area. One is to be located within 12" (30 cm) above the floor and the other is to be located within 12" (30 cm) below the ceiling.

The minimum net free area of each opening must not be less than one square inch (6.5 cm²) per 1000 Btuh (0.3 kw) of the total input rating of all the appliances in the enclosure (but not less than 100 square inches [650 cm²]) if each opening communicates with other unconfined areas inside the building. The above requirements shall be used unless: national, provincial, or local codes govern the requirement for these air openings.

Buildings of unusually tight construction shall have the combustion and ventilation air supplied from outdoors, or a freely

ventilated attic or crawl space.

If air is supplied from outdoors, directly or through vertical ducts, there must be two openings located as specified above and each must have a minimum net free area of not less than one square inch (6.5 cm²) per 4000 Btuh (1.2 kw) of the total input rating of all the appliances in the enclosure.

If horizontal ducts are used to communicate with the outdoors, each opening must have a minimum net free area of not less than one square inch (6.5 cm²) per 2000 Btuh (0.6 kw) of the total input rating of all the appliances in the enclosure. If ducts are used, the minimum dimensions of rectangular air ducts shall not be less than 3" (7.6 cm).

NOTICE: If the duct openings which supply combustion and ventilation air are to be covered with a protective screen or grill, the net free area (openings in the material) of the covering material must be used in determining the size of the openings. Protective screening for the openings MUST NOT be smaller than 1/4" (0.64 cm) mesh to prevent clogging by lint or other debris.

Additional installation information for The Commonwealth of Massachusetts is located on the back page of this manual.

NOTICE: The water heater should not be installed near an air supply containing halogenated hydrocarbons.

Corrosive Atmospheres

The air in beauty shops, dry cleaning establishments, photo processing labs, and storage areas for liquid and powdered bleaches or swimming pool chemicals often contains such halogenated hydrocarbons.

An air supply containing halogenated hydrocarbons may be safe to breathe, but when it passes through a gas flame, corrosive elements are released that

will shorten the life of any gas burning appliance.

Propellants from common spray cans or gas leaks from A/C and refrigeration equipment are highly corrosive after passing through a flame.

The water heater warranty is voided when failure of the heater is due to operation in a corrosive atmosphere.

Inspect Shipment

Inspect the water heater for possible damage. Check the markings on the rating plate of the water heater to be certain the type of gas supplied corresponds to the water heater requirements. Verify all included parts are present (see below).



Installing the (INDOOR) water heater:

The water heater must be installed with a 4" diameter UL approved Category III Stainless Steel appliance vent pipe and an appropriate adapter.

▲ DANGER: Failure to install the appliance vent adapter and properly vent the water heater to the outdoors as outlined in the Venting section of this manual will result in unsafe operation of the water heater, causing death, serious injury, explosion, or fire. To avoid the risk of fire, explosion, or asphyxiation from carbon monoxide, NEVER operate the water heater unless it is properly vented and has adequate air supply for proper operation as outlined in the Venting section of this manual.

▲ WARNING: Use 4" UL approved Category III Stainless Steel vent material only. No other vent material is permitted.

▲ WARNING: Refer to page 8 for clearances to combustible material.

Venting

The installation of venting must comply with national codes, local codes and the vent manufacturer's instructions.

The water heater must be vented to the outdoors as described in these instructions. **DO NOT** connect this water heater to a chimney. It must be vented separately from all other appliances.

All vent components (adapters, pipe, elbows, terminals, etc.) should be UL 1738 Certified Stainless Steel Venting Material (e.g. AL29-4C).

The specified vent termination must be used. The termination should be a 90° elbow with screen. (Refer to pages 14 and 15 for an example of 90° termination)

Use a vent pipe with an anti-disconnection joint.

The use of a High Temperature Silicone (500°F [260°C]) may be required to seal vent connections. To prevent accidental gas exhaust leakage, apply a 1/4" (6 mm) wide bead approximately 1/4" (6 mm) from the end and another bead against the joint side of the stop bead.

Follow vent manufacturer's installation instructions and their recommended clearances to combustibles.

The unit can be vented either horizontally or vertically.

Vent pipe runs must be adequately supported along both horizontal and vertical runs.

The maximum recommended unsupported span should be no more than five (5) feet (1.5 m). Support isolation hanging bands should be used. **DO NOT** use wire. (See diagram below).

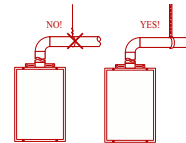

Notes on pre-existing vent:

If the water heater is being installed as a replacement for an existing water heater, a thorough inspection of the existing venting system must be performed prior to any installation work. Verify that the correct materials, vent lengths and terminal locations as detailed in this Use and Care Manual have been met. Carefully inspect the entire venting system for any signs of cracks or fractures, particularly at the joints between elbows or other fittings and the straight runs of vent pipe. Check the system for signs of sagging or other stresses in the joints as a result of misalignment of any components in the system. If any of these conditions are found, they must be corrected in accordance with the venting instructions in this manual before completing the installation and putting the water heater into service.

Venting Lengths

MAXIMUM VENT LENGTH: The system will not operate if there is excessive restriction (pressure drop) in the venting system. A maximum of 47' 6" (14.4 m) vent pipe may be used provided there is only one 90° elbow in the system. If additional elbows are required: two elbows can be used with 42' 6" (13 m) and three elbows can be used with 37' 6" (11.4 m).

A 90° elbow is equivalent to 5' (1.5 m) of straight pipe. A 45° elbow is equivalent to 2' 6" (76 cm) of straight pipe.

The termination elbow does not count as an elbow when determining total vent lengths.

The vent can be installed with a slight downward slope of 1/4" per foot of horizontal run toward the vent terminal (see

diagram below). This ensures that any condensate formed during operation of the unit is evacuated from the appliance.

A 1/4" per foot upward slope is acceptable when it is not possible to vent with a downward slope; however, a UL approved Category III Stainless Steel condensate trap **MUST** be installed at the beginning of the horizontal run. (See page 14 "Example B: Typical Horizontal Termination w/ 1/4" per foot UPWARD Slope" or page 15, "Standard Vertical Vent Termination" for examples).

MINIMUM VENT LENGTH: The venting may be as short as 12" (30 cm), provided one vent termination is installed to the outdoors through a sidewall, one 90° elbow is included in the installation and the wall thimble is installed.

Notice: Make sure that the seam of the vent pipe in horizontal runs is toward the top of the installation (see diagram to the far left).

Number of 90° elbows (bends)	Maximum Length of Straight Pipe
1	47' 6" (14.4 m)
2	42' 6" (13 m)
3	37' 6" (11.4 m)

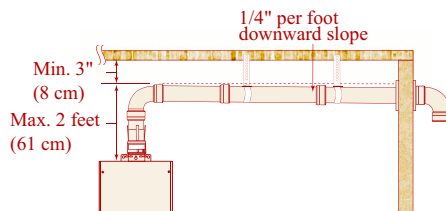
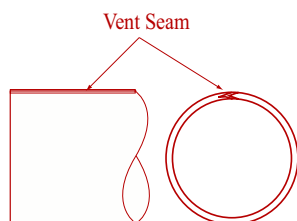

Venting Through Closed Spaces

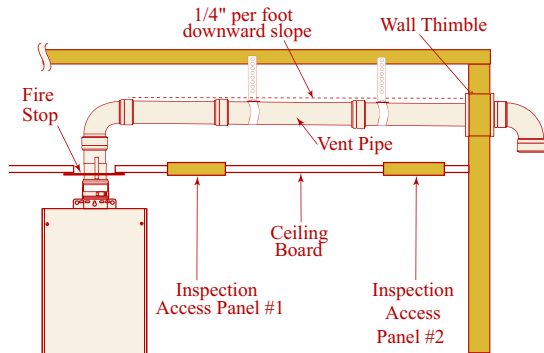

If the vent piping passes through a closed space, a minimum clearance of 8" (20 cm) when installed horizontally or 6" (15 cm) when installed vertically should be maintained between the vent pipe and combustibles and noncombustibles. Be sure to follow local codes and vent manufacturer's installation instructions.

For maintenance and inspection purposes, the following access panels are required.

- Two (2) inspection access panels large enough to allow access for venting inspection. One (1) of these access panels should be close to where the vent pipe enters the ceiling. The other access panel should be near the vent termination.
- A ventilation access panel with a 16 in² (103 cm²) opening should be provided every 10 ft (3 m).

CAUTION: Ensure that the appliance vent adapter is securely attached to the water heater collar.

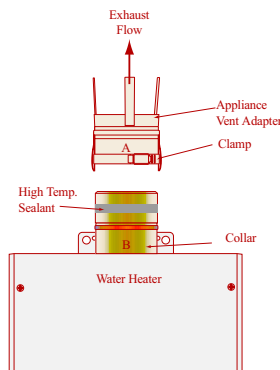

Appliance Vent Adapter

The water heater must be installed with a UL 1738 approved Category III Stainless Steel appliance vent adapter.

Read the following instructions before installation.

- Test fit the adapter over the water heater collar before proceeding. Adjust clamp as needed.
- With an alcohol wipe, clean inside surface "A" of adapter and outside surface "B" of heater collar.
- Apply 1/4" (6 mm) wide bead of high temperature silicone (500°F [260°C]) around outside of heater collar "B".

- Slide adapter end "A" down over heater collar "B" as far as it will go.
- Tighten the clamp around the collar.
- Inspect the inside of the adapter to verify that the collar and adapter are sealed. If more sealant is required, apply sealant to a flat tool, then spread around the collar edge on inside of adapter.
- Ensure that the clamp does not interfere with the damper shaft.

NOTICE: Follow the appliance vent adapter manufacturer's instructions.

CAUTION: Condensate is known to be acidic; refer to local, state (provincial) or federal codes for proper handling and discharge methods.

CAUTION: Condensate must drain away from the water heater and should not be allowed to drain back into any part of the vent system.

WARNING: Failure to provide a vent condensate drain close to the appliance could allow acidic flue gas condensate to enter into appliance flueways, causing premature failure of the appliance.

Draining the Condensate

Provision should be made to collect and dispose of condensate from venting systems.

When a water heater is **vented horizontally**, the vent pipe can have a DOWNWARD or UPWARD slope towards the termination. If an UPWARD slope is used, a condensate trap must be installed as close as practical to the water heater in order to prevent condensate from draining back into the water heater. See Examples A and B on page 14 for DOWNWARD and UPWARD slope for horizontally vented water heaters.

When a water heater is **vented vertically**, an UPWARD slope must always be used. A condensate trap must be installed in the horizontal section of the vent and as close as practical to the water heater in order to prevent condensate from draining back into the water heater. See the diagram on page 15 showing UPWARD slope for vertically vented water heaters.

Always attach a drain hose to the drain fitting and plumb the hose to a sanitary sewer drain.

A high temperature silicone tubing suitable for use with acidic condensate and appropriate for the temperature range should be used.

The drain tube is fashioned into a "pigtail" trap and must be filled with water to prevent flue gases from emitting into the building prior to operating the appliance.

Installing the water heater:

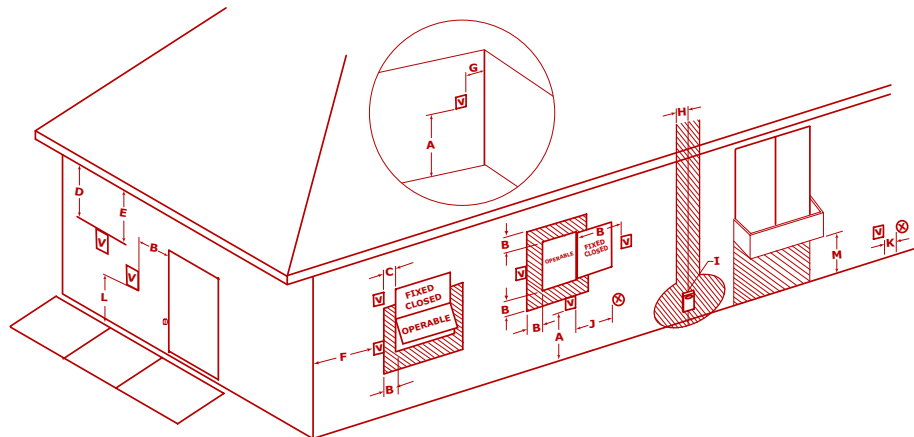

V VENT TERMINAL
 X AIR SUPPLY INLET
 ▨ AREA WHERE TERMINAL IS NOT PERMITTED

Horizontal Vent Terminal Location

The following information should be used for determining the proper location of the vent terminal for indoor and outdoor tankless water heaters.

	Canadian Installations ¹ Indoor and Outdoor	US Installations ² Indoor	US Installations ² Outdoor
A= Clearance above grade, veranda, porch, deck or balcony.	12 inches (30 cm) above anticipated snow level.	12 inches (30 cm) above anticipated snow level.	12 inches (30 cm) above anticipated snow level.
B= Clearance to window or door that may be opened.	6 inches (15 cm) for appliances ≤ 10,000 Btuh (3 kW), 12 inches (30 cm) for appliances > 10,000 Btuh (3kW) and ≤ 100,000 Btuh (30kW), 36 inches (91 cm) for appliances > 100,000 Btuh (30kW).	4 feet (1.2 m) below or to side of opening; 1 foot (300 mm) above opening.	6 inches (15 cm) for appliances ≤ 10,000 Btuh (3 kW), 9 inches (23 cm) for appliances > 10,000 Btuh (3kW) and ≤ 50,000 Btuh (15kW), 12 inches (30 cm) for appliances > 50,000 Btuh (15kW).
C= Clearance to permanently closed window.	*	*	*
D= Vertical Clearance to ventilated soffit located above the terminal within a horizontal distance of 2 feet (61 cm) from the center line of the terminal.	*	*	*
E= Clearance to unventilated soffit.	*	*	*
F= Clearance to outside corner.	*	*	*
G= Clearance to corner.	*	*	*
H = Clearance to each side of center line extended meter/regulator assembly, above	3 feet (91 cm) within a height 15 feet (4.57 m) above the meter/regulator assembly.	*	*
I = Clearance to service regulator vent outlet.	3 feet (91 cm)	*	*
J = Clearance to nonmechanical air supply inlet to the combustion air inlet to any building or other appliance.	6 inches (15 cm) for appliances ≤ 10,000 Btuh (3 kW), 12 inches (30 cm) for appliances > 10,000 Btuh (3kW) and ≤ 100,000 Btuh (30kW), 36 inches (91 cm) for appliances > 100,000 Btuh (30kW).	4 feet (1.2 m) below or to side of opening; 1 foot (300 mm) above opening.	6 inches (15 cm) for appliances ≤ 10,000 Btuh (3 kW), 9 inches (23 cm) for appliances > 10,000 Btuh (3kW) and ≤ 50,000 Btuh (15kW), 12 inches (30 cm) for appliances > 50,000 Btuh (15kW).
K = Clearance to mechanical air supply inlet.	6 feet (1.83 m)	3 feet (91 cm) above if within 10 feet (3 m) horizontally.	3 feet (91 cm) above if within 10 feet (3 m) horizontally.
L = Clearance above paved sidewalk or paved driveway located on public property.	Not Allowed	Not Allowed	Not Allowed
M = Clearance under veranda, porch, deck or balcony.	Not Allowed	Not Allowed	Not Allowed

* If clearances are not specified, then follow local installation codes and the requirement of the gas supplier.

** For condensing appliances: The vent for this appliance shall not terminate over public walkways, near soffit vents, crawl space vents, or other areas where condensate or vapor could create a nuisance, hazard or cause property damage, or where condensate or vapor could cause damage or could be detrimental to the operation of regulators, relief valves or other equipment.

Outdoor Water Heater

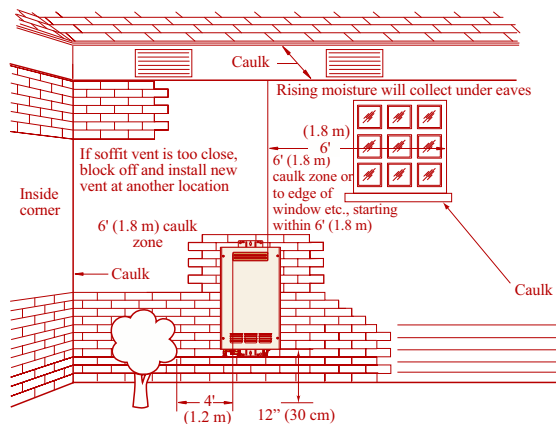

Indoor Water Heater

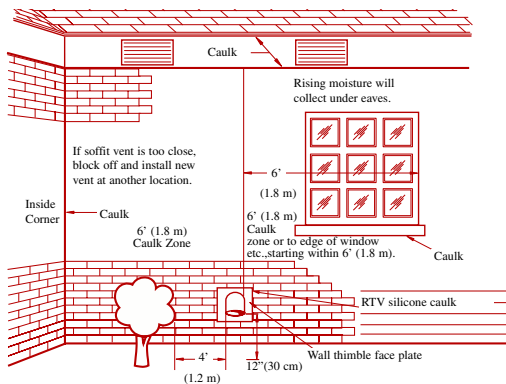

⚠ WARNING: Moisture in the flue gas will condense as it leaves the vent terminal. In cold weather this condensate can freeze on the exterior wall, under the eaves and on surrounding objects. Some discoloration on the exterior of the building is to be expected. However, improper location or installation can result in severe damage to the structure or exterior finish of the building.

Additional Considerations

- 1 Do NOT install vent terminal under any patio or deck.
- 2 To help prevent moisture from freezing on walls and under eaves, do not locate vent terminal on the side of a building with prevailing winter winds.
- 3 To help prevent water lines from freezing, do not locate vent terminal on the side of a building with prevailing winter winds.
- 4 Do Not terminate vent directly on brick or masonry surfaces. A rust resistant sheet metal backing plate (1 x 1 foot)(30 x 30 cm) is recommended behind vent. (See Figure.)
- 5 Do NOT locate vent terminal too close to shrubbery, as flue gases may damage them.
- 6 Caulk all cracks, seams and joints within six (6) feet (1.8 m) of vent terminal.
- 7 Caulk around thimble face plate for weather tight seal.
- 8 All painted surfaces should be primed to lessen the chance of physical damage. Painted surfaces will require maintenance.
- 9 Insulate vent pipe of water heaters exposed to cold conditions (attics, crawl spaces, etc.) with inflammable material to help prevent moisture from accumulating in vent pipe. The insulation should be rated for the temperature and should not contain substances that corrode the vent pipe.
- 10 Do NOT extend exposed vent pipe of indoor water heaters outside of building.
- 11 Guard vent against accidental contact with people and pets.
- 12 Install outdoor water heater such that air inlet and flue outlet is above anticipated snow level.

Vertical Vent Termination Location

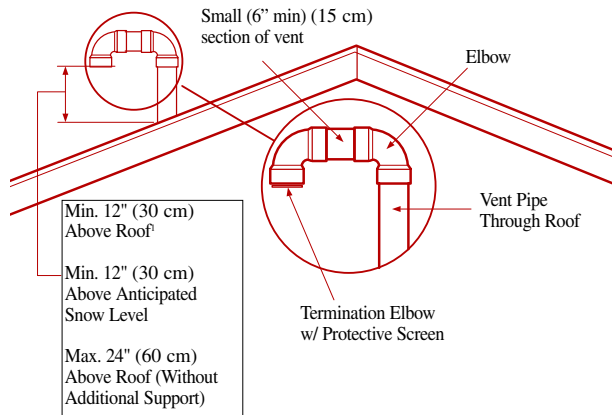

The location of the vent terminal depends on the following minimum clearances and considerations (see diagram at left):

- 1 Minimum twelve (12) inches (30 cm) above roof.²
- 2 Minimum twelve (12) inches (30 cm) above anticipated snow level.
- 3 Maximum twenty-four (24) inches (60 cm) above roof level without additional support for vent.
- 4 Four (4) feet (1.2 m) from any gable, dormer or other roof structure with building interior access (i.e., vent, window, etc.).
- 5 Ten (10) feet (3 m) from any forced air inlet to the building. Any fresh or make-up air inlet such as a dryer or furnace area is considered to be a forced air inlet.³

¹ Min. 18" (46 cm) above roof for installations in Canada.

² For installations in Canada 18" (45.7 cm).

³ For installations in Canada 6' (1.8 m).

Vertical Vent Installation

Notice: Only Rheem approved termination and parts should be used during installation.

Notice: Follow vent manufacturer's installation instructions and their recommended clearances to combustibles as required.

A fire stop plate should be installed at every penetration of a floor or ceiling if the vent is not running in a fire-rated shaft. Maintain the recommended air space clearance to combustible materials and building insulation.

Once the vent terminal location has been determined, make a hole through the roof and interior ceiling to accommodate the vent pipe. Complete the vent pipe installation to the water heater's vent connector fitting on the water heater vent collar outlet. Support vertical or horizontal runs as previously mentioned. If required, use silicone sealant at the point the vent connector joins the water heater.

Install adequate flashing where the vent pipe passes through the roof. Determine the vent terminal height and install the vent pipe accordingly. Refer to the diagram above for proper vent terminal height. Connect vent elbow onto vertical pipe through roof. Connect short piece of vent pipe (approximately 6" long [15 cm]) to elbow, and the terminal elbow with the protective screen.

The vent roof system must terminate at least 1 foot (30 cm) above the roof line and at least 2 feet (61 cm) higher than any portion of the building within 10 feet (3 m).

Install supports every 5 feet (1.5 m) vertically along the vent pipe route. Vertical supports

are required after every transition to vertical and are required after every offset elbow. When the vent is free-standing and penetrates a roof/ceiling, another means of support must be used at a second location.

Follow the vent manufacturer's recommended installation instructions provided with the vent purchased from the manufacturer.

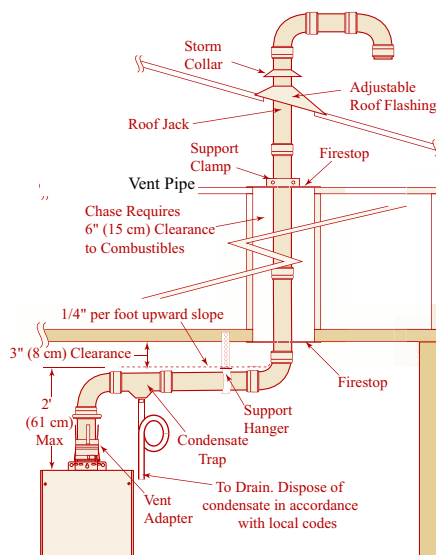

Standard Vertical Vent Termination

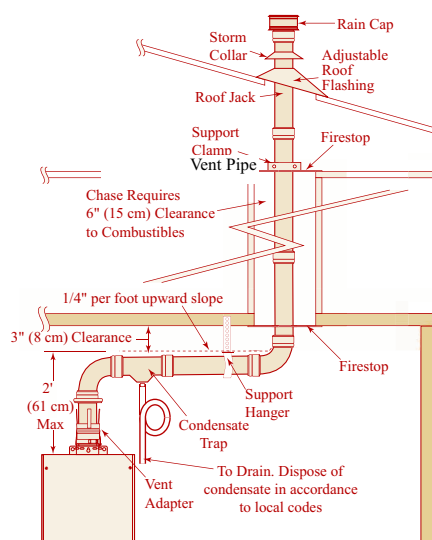

Alternate Vertical Vent Termination with Rain Cap

Installing the water heater:

▲ CAUTION:
Reinforcement of the wall is required in case the wall is not strong enough to hold the appliance.

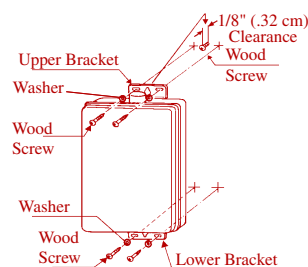

Mounting the Water Heater

Make sure the location of the appliance allows for easy access and operation.

Wall studs should be utilized when mounting the water heater to the wall. Alternately, a suitable piece of wood may be placed inside or outside of the wall to span the distance between the wall studs. Fasten the water heater mounting brackets to the wood.

In case of dry wall or concrete wall, use drywall anchors or lag bolts.

The water heater requires 120VAC/60Hz. Have a receptacle with ground terminal near the water heater. The length of the power supply cord is 10 feet (3 m) (indoor water heater only.)

Install a wood screw for the upper bracket with a clearance of 1/8" (.32 cm) between the wall and the screw head. Hang the center of the upper bracket on the screw.

Using a wood screw and a washer, affix the lower bracket to the wall (Left and Right). Repeat to affix the top bracket.

The brackets can be adjusted to change the distance between the back of the appliance and the wall within the range of 3/8" (.95 cm) to 1-1/2" (3.8 cm).

Loosen the adjustment screws of both the top and the bottom brackets to adjust the distance (See diagram below).

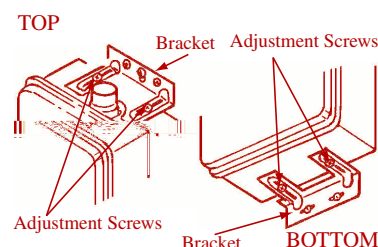

Thermal Expansion

A thermal expansion tank will be required if the water heater is installed in a closed loop system to prevent damage to heater, related piping and relief valve. Replacing the relief valve will not correct the problem! The expansion tank is designed with an air cushion built in that compresses as the system pressure increases, thereby relieving the over pressure

condition and eliminating the repeated operation of the relief valve. Other methods of controlling thermal expansion are also available. Contact your installing contractor, water supplier or plumbing inspector for additional information regarding this subject.

IMPORTANT: Do not apply heat to the HOT or COLD water connections. If sweat connections are used, sweat tubing to adapter before fitting adapter to the water connections on heater. Any heat applied to the water supply fittings will permanently damage the internal components of the water heater.

Water Supply Connections

Plumbing should be carried out by a qualified plumber in accordance with local codes.

Use approved plumbing materials only.

The diameter of the pipe lines should be a minimum of 3/4"(2 cm).

To conserve energy and to prevent freezing, insulate both cold and hot water supply lines. DO NOT cover the drain or pressure relief valve.

To ensure proper operation of the water heater, the following water pressure guidelines should be followed:

- Operation of the water heater requires the minimum water pressure of 14 psi (97 kPa) and a minimum water flow rate of 0.66 gpm (2.5 lpm).
- A water pressure of 40 psi (276 kPa) is required to achieve maximum flow rate.
- To maintain proper performance, ensure sufficient water supply pressure. The

Required Water Pressure = Min. Operating Water Pressure (14 psi [97 kPa]) + Pipe Pressure Loss + Faucet and Shower Pressure Loss + Safety Margin (more than 5 psi [34 kPa]).

- To supply hot water to upper floors, additional water pressure (0.44 psi/ft [10 kPa/m]) must be ensured. The measurement should be calculated by the distance between the water inlet of the water heater (ground level) to the hot water faucet (upper floor level).
- Well water systems should be set to ensure a minimum system pressure of 40 psi (276 kPa). The pressure should remain stable during the operation of the water heater.
- When the water is supplied from a water supply tank, the height of the tank and the diameter of the pipes and their relation to water pressure should be taken into consideration. **Gravity water pressure is not recommended.**

Water Supply Connections, continued

⚠ CAUTION: This water heater must only be used with the following water supply system conditions:

- With clean, potable water free of corrosive chemicals, sand, dirt or other contaminants.
- With inlet water temperatures above 32°F (0°C), but not exceeding 120°F (49°C) for Light Duty models and up to 140°F (60°C) for Heavy Duty models.
- Free of lime and scale deposits.
- DO NOT reverse the hot and cold water connections. The water heater will not operate.

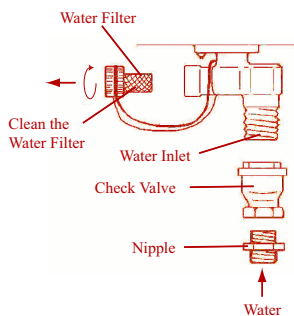

Notice: Use only teflon tape on cold and hot water connections and lines.

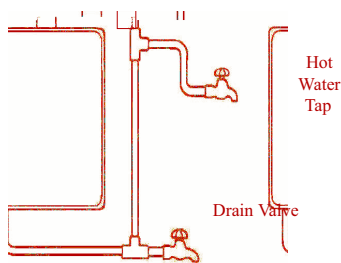

This appliance is not intended for space heating application. Do not connect this heater to waterlines previously used for space heating or non-potable water distribution. All water piping and components shall be suitable for potable water.

Notice: If the water flow resistance of a shower head is too high, the burner in the water heater will fail to ignite. Keep the shower head clean from debris that could cause additional pressure drop.

Notice: If using mixing valves on the outlet, choose one that prevents cold water pressure from overcoming hot water line pressure.

Notice: If multiple water heaters are installed in a manifold system, the water piping must be in "Parallel". A water pressure of 40 psi (276 kPa) is recommended for each water heater for proper operation of the water heaters.

Alternate Water Piping Arrangement with Optional Valve Kit

Valve kits may be purchased and installed as optional items. Contact your distributor or place of purchase for details. They allow for one person full diagnostic testing and ease of flushing the system. The kit includes two full port isolation valves, one for the cold side and one for the hot side. Refer to page 23.

Install a shutoff valve near the inlet of the water heater for service and draining purposes.

It is not recommended to use pipes with smaller diameters than the water supply connection of the water heater.

Before connecting the water supply pipe to the water heater, open the shutoff valve and clean out sand, debris, air, caulking material, etc. inside the pipe. Connect to the water inlet, then check water flow. Close the shutoff valve and clean the water filter.

Be sure to connect the water inlet and the hot water outlet as shown on the water heater. If reversed, the water heater will not function.

Installation of unions or flexible copper connections are recommended on the HOT and COLD water lines, so that the water heater may disconnect easily for servicing, if necessary.

Install a Check Valve between the water heater and the water shutoff valve (see the top left diagram).

The following should be addressed in regards to the HOT WATER OUTLET:

- Connections between the water heater and point(s) of use should be as short and direct as possible.
- Local codes shall govern the exact type of pipe material that is to be used for water connections.
- To conserve energy and minimize heat loss, insulation of hot water piping is recommended (see Hot and Cold Pipe Insulation Installation on page 24).

Notice: The flow rate of hot water may vary when more than two faucets (appliances, fixtures, etc.) are being used simultaneously.

Notice: The pipes MUST be completely drainable. If the hot water faucets are located at a point higher than the water heater, place a drain valve at the lowest point (see diagram at the left).

Installing the water heater:

Relief Valve

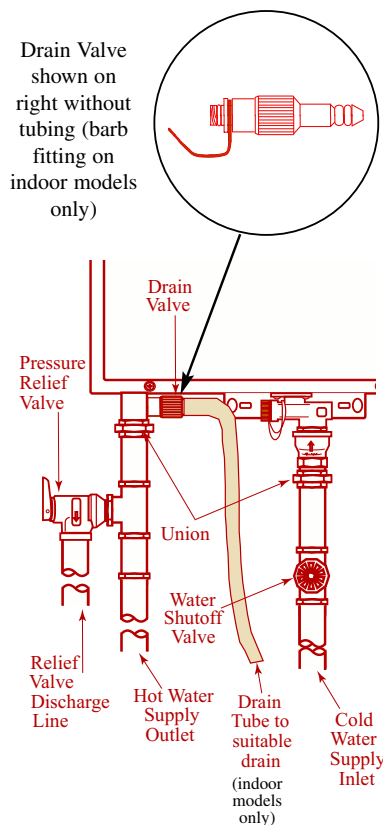

Notice: The above illustrates a pressure-only relief valve. If local codes require a combination temperature and pressure relief valve be installed, an extension piece may be needed to ensure that the valve probe is not directly in the flow path of the water.

A new pressure relief valve, complying with the Standard for Relief Valves and Automatic Gas Shut-Off Devices for Hot Water Supply Systems, ANSI Z21.22/CSA 4.4, must be installed at the hot water outlet connection of the water heater at the time of installation. Local codes shall govern the installation of relief valves.

For safe operation of the water heater, be sure that:

- The pressure rating of the relief valve must not exceed 150 psi (1034 kPa), the maximum working pressure of the water heater as marked on the rating plate.
- The BTUH rating of the relief valve must equal or exceed the BTUH input of the water heater as marked on its rating plate.
- No valve of any type should be installed between the relief valve and the water heater
- Discharge from the relief valve should be piped to a suitable drain to eliminate potential water damage. Piping used should be of a type approved for the distribution of hot water.
- Hot and cold water lines should be insulated up to the water heater. Refer to page 24 for details.
- The discharge line must be NO SMALLER than the outlet of the relief valve and must pitch downward to allow complete drainage (by gravity) of the relief valve and discharge line.

- The end of the discharge line should not be threaded or concealed and should be protected from freezing. No valve of any type, restriction or reducer coupling should be installed in the discharge line.

Notice: Local codes govern the installation of relief valves. If local codes require that a temperature and pressure relief valve should be installed, the manufacturer recommends a type 40XL Watts T&P relief valve or an equivalent model be used.

Notice: Manual operation of relief valves should be performed at least once a year. Turn off the electrical power and gas shutoff valve. Lift and release lever on the relief valve and check the manual operation of the relief valve. You should take precaution to avoid contact with the hot water coming out of the relief valve and to prevent water damage.

Notice: If the relief valve on the system discharges periodically, a problem exists and service to the water system is required.

The vinyl tubing as shown is supplied only with indoor water heaters and connects to the drain valve located at the hot water outlet as shown in the diagram at left. Route the other end of the vinyl tubing to the drain pan or a suitable drain where leakage from the heater will not result in damage to the area adjacent to the heater or to lower floors of the structure.

⚠ WARNING: Do not attempt to convert this water heater for use with a different type of gas other than the type shown on the rating plate. Such conversion could result in hazardous operating conditions.

Gas Supply

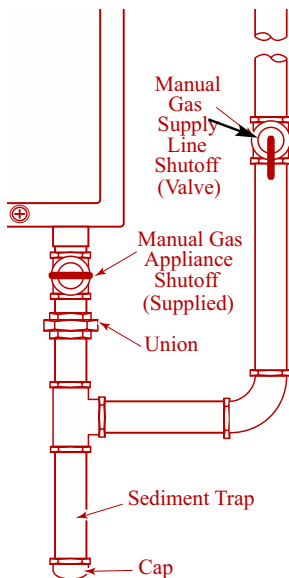

The supplied Manual Gas Appliance Shutoff Valve must be installed at the gas connection of the water heater at the time of installation (see diagram to the left).

The branch gas supply line to the water heater should be a minimum of 3/4" black steel pipe or other approved gas piping material.

A ground joint union or ANSI design certified semi-rigid or flexible gas appliance connector should be installed in the gas line close to the water heater. The National Fuel Gas Code (NFGC) ANSI Z223.1 and CAN B149 code mandates a manual gas shut-off valve: See NFGC & B149 for complete instructions.

If flexible connectors are used, the maximum length shall not exceed 36" (91 cm).

If lever type gas shut offs are used, they shall be T-Handle type.

Compound used on the threaded joints of the gas piping must be of the type resistant to the action of LP gas. Use compound sparingly on male threads only.

A sediment trap should be installed at the bottom of the gas line.

Do not use excessive force (over 31.5 ft lbs. [42.7 Nm]) in tightening the pipe, particularly if teflon pipe compound is used, as the unit may be damaged.

The inlet gas pressure to the water heater must not exceed 10.5" w.c. (2.6 kPa) for natural or 14" w.c. (3.5 kPa) for LP gas. For purposes of input adjustment, the minimum inlet gas pressure (with main burner on) is shown on the water heater rating plate. If high or low gas pressures are present, contact your gas supplier for correction.

NOTICE: To ensure proper operation of the heater the gas pipe and gas meter must be sized correctly.

Gas piping shall be in accordance with local, utility company requirement and/or in the absence of local codes, use the latest edition of the National Fuel Gas Code. In Canada, the latest edition of CSA B149.1 Natural Gas and Propane installation code.

⚠ WARNING: Never use an open flame to test for gas leaks, as property damage, personal injury, or death could result.

Leak Testing

The water heater and its gas connections must be leak tested at normal operating pressures before it is placed in operation.

1 Turn on the gas shut-off valve(s) to the water heater.

2 Use a soapy water solution to test for leaks at all connections and fittings. Bubbles indicate a gas leak that must be corrected.

The factory connections should also be leak tested after the water heater is placed in operation.

⚠ WARNING: Install a gas pressure regulator, in the gas supply line, which does not exceed the maximum supply pressure.

DO NOT use an industrial type gas regulator.

Pressure Testing the Gas Supply System

The water heater and its manual gas shut-off valve must be disconnected from the gas supply piping system during any pressure testing of the system at pressures in excess of 1/2 psi (14" w.c. [3.5 kPa]).

The water heater must be isolated from the gas piping system by closing the manual gas shut-off valve during any pressure testing of the gas supply piping at pressures equal to or less than 1/2 psi (14" w.c. [3.5 kPa]).

High Altitude

This water heater is certified for installations up to 3,280 feet (1000 m) above sea level. The input rating of this water heater is based on sea level operation. At higher elevations, the actual input rate may be lower than the value listed on the rating label.

NOTICE: Select High Altitude models are available. One model is available for use at elevations above 3,280 feet (1,000 m) up to 6,560 feet (2,000 m), and an additional model is available for use at elevations above 6,560 feet (2,000 m) up to 9,840 feet (3,000 m).

NOTICE: For installations above 3,280 feet (1,000 m) elevation, the Altitude Chip on the PC board must be replaced. Do not install this water heater at elevations above 3,280 feet (1,000 m) without installing the proper Altitude Chip. Please contact your installer, local gas supplier, place of purchase or the Customer Service phone number as listed in this Use & Care Manual for more information.

Installing the Main Remote Control:

▲ WARNING: Field wiring connections and electrical grounding must comply with local codes, or in the absence of local codes, with the latest edition of the National Electrical Code, ANSI/NFPA 70, or in Canada, Canadian Electrical Code, CSA C22.1 Part 1.

Remote Control Installation

NOTICE: The provided remote control will allow a maximum temperature setting of 120°F (49°C). Temperatures of up to 140°F (60°C) for Light Duty models and up to 180°F (82°C) for Heavy Duty models can be achieved with the MAIN (UMC-117) remote control and a dip switch adjustment. Only Heavy Duty water heaters can achieve temperatures up to 180°F (82°C). Only qualified service personnel should perform this adjustment.

NOTICE: If the Heavy Duty water heaters are installed in a manifold system, the main remote control connected to the manifold controller (MIC-180) has priority over the remote controls connected to the water heater.

NOTICE: An optional cable (EZ Link Cable™) can be purchased separately to manifold two heaters of either Light Duty or Heavy Duty together.

One (1) remote control is provided with the water heater. Additional remote controls may be purchased separately. Up to three (3) remote controls can be used with this water heater.

The following are considerations for determining the location of the remote control(s):

- **DO NOT** install any remote control outdoors or in areas where it can come in contact with water.
- Place remote control out of children's reach.
- The remote control can be installed in convenient locations such as the kitchen, laundry room, utility room, or directly beside the indoor water heater.
- Avoid areas where the remote control may be exposed to heat, e.g. stove, ranges or heaters.

- Avoid areas where the remote control may be subjected to oil and/or steam from cooking.
- Avoid areas where chemical agents (such as thinner, benzene and alkalines) are used.
- Avoid areas of direct sunlight.
- The MAXIMUM distance between the water heater and the remote control installation location is limited to 195 feet (59 m) of wire.

NOTICE: Only one of each type of remote controls can connect to the water heater. Therefore, a maximum of three controls can connect to the water heater.

No other manufacturer's controls are suitable for use with this water heater.

DO NOT attempt to disassemble the remote control.

Remote Control Model Number	Remote Control Description	Temperature Set Point Range	Availability	Models
USC1-117	BATH 1	100°F - 120°F (38°C)-(49°C)	Optional (Sold Separately)	Light Duty Only
USC2-117	BATH 2	100°F - 120°F (38°C)-(49°C)	Optional (Sold Separately)	Light Duty Only
UMC-117	MAIN	100°F - 120°F (38°C)-(49°C)	Provided with Heater (Factory Default)	Light and Heavy Duty
		125°F - 140°F (52°C)-(60°C)	With Dip Switch Adjustment	Light Duty
		125°F - 180°F (52°C)-(82°C)	With Dip Switch Adjustment	Heavy Duty
MIC-180 Manifold System	Manifold System	-----	Optional Sold Separately	Heavy Duty Only

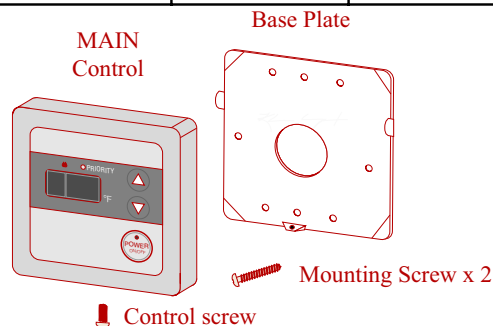

⚠ WARNING: Field wiring connections and electrical grounding must comply with local codes, or in the absence of local codes, with the latest edition of the National Electrical Code, ANSI/NFPA 70, or in Canada, Canadian Electrical Code, CSA C22.1 Part 1.

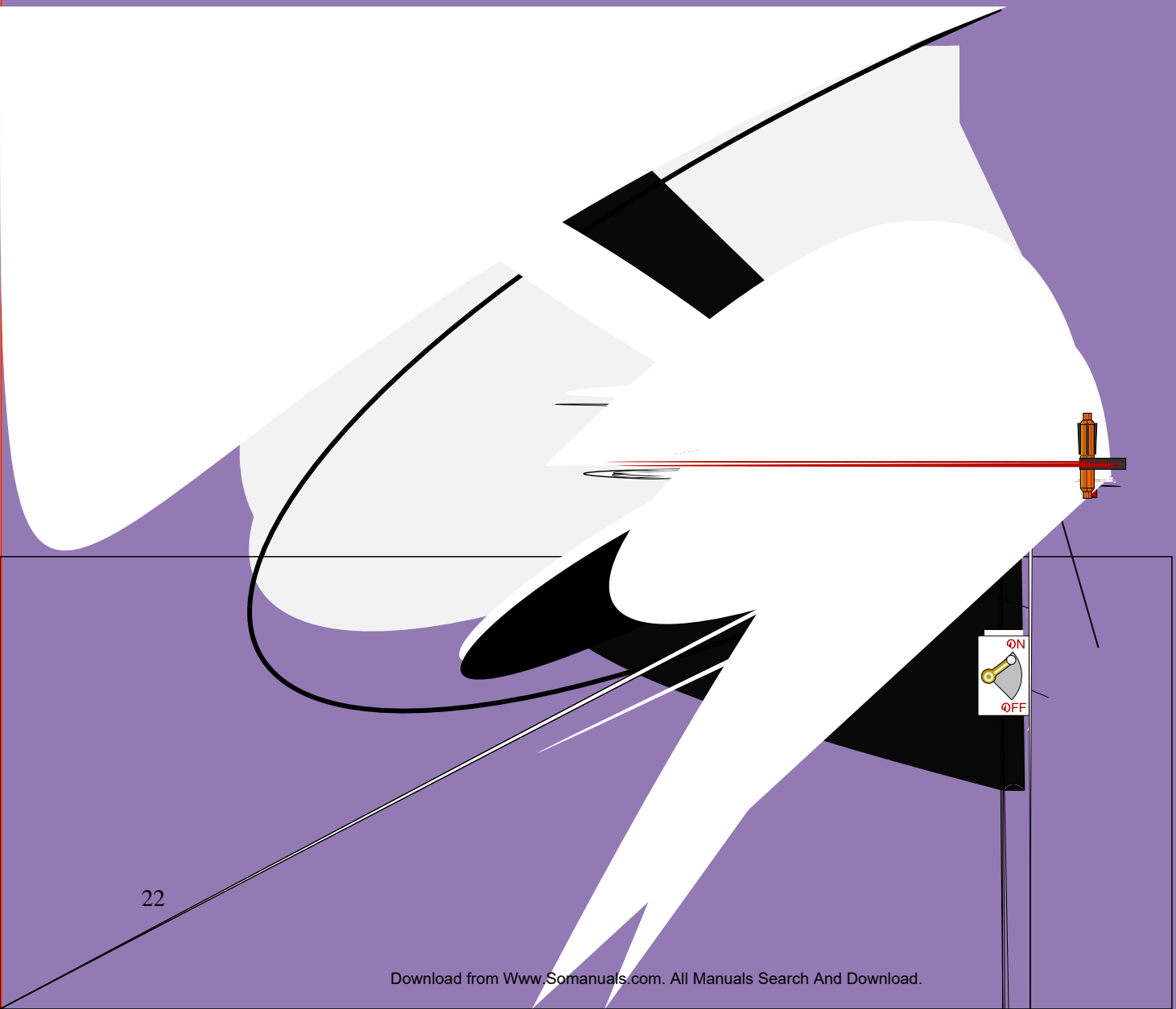

Installing the water heater:

Typical Installation of Water Heater (Venting Required for Indoor Models Only)

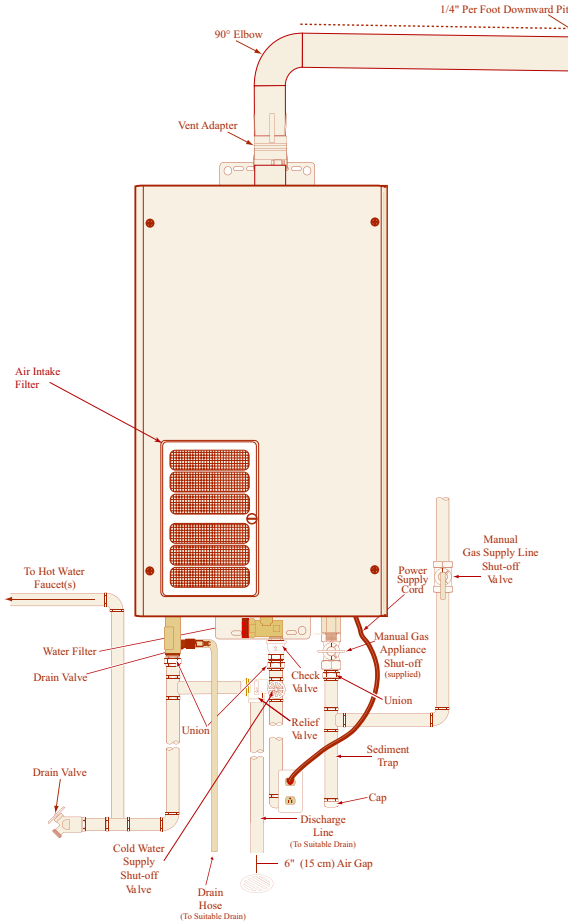

Indoor Models

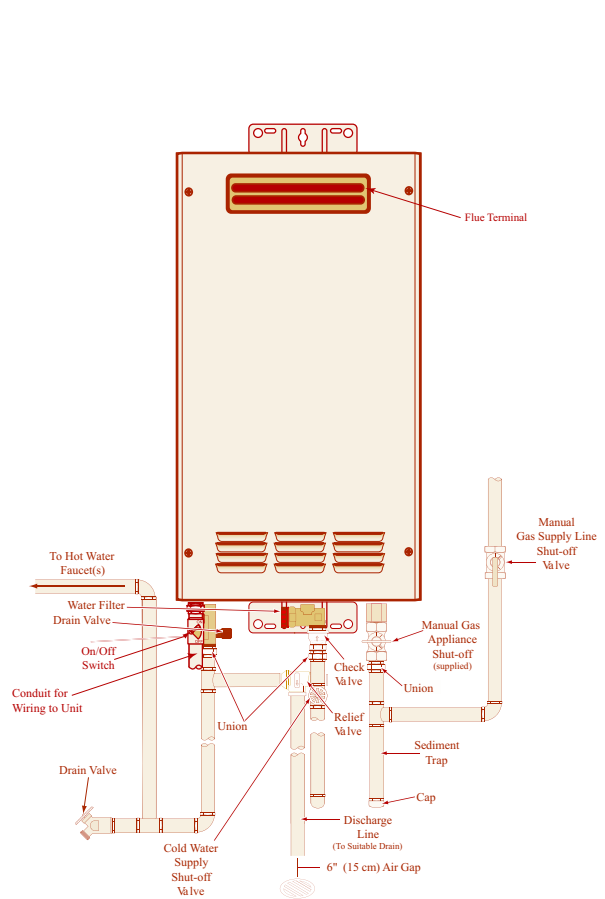

Outdoor Models

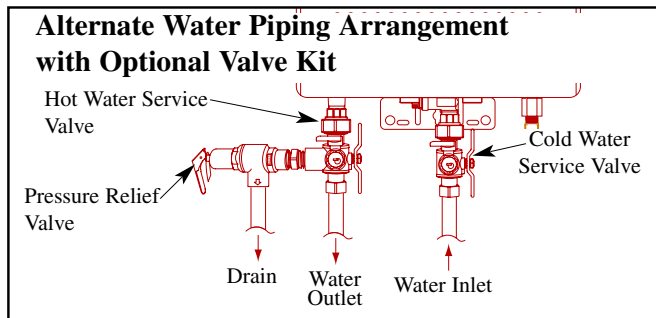
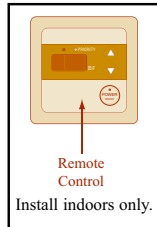

NOTICE: The National Fuel Gas Code (NFGC) and B149 mandates a manual gas shut-off valve: See NFGC/B149 for complete instructions. Local codes or plumbing authority requirements may vary from the instructions or diagrams provided and take precedent over these instructions.

Installing the water heater:

▲ WARNING: If local codes require external application of insulation blanket kits the manufacturer's instructions included with the kit must be carefully followed.

Insulation Blankets

Insulation blankets, available to the general public for external use on gas water heaters, are not necessary. The purpose of an insulation blanket is to reduce the standby heat loss encountered with storage tank heaters. This water heater does not store water making an insulation blanket unnecessary.

The manufacturer's warranty does not cover any damage or defect caused by installation, attachment or use of any type of energy saving or other unapproved devices (other than those authorized by the manufacturer) into, onto or in conjunction with the water heater. The use of unauthorized energy saving devices may shorten the life of the water heater and may endanger life and property.

The manufacturer disclaims any responsibility for such loss or injury resulting from the use of such unauthorized devices.

CAUTION: If local codes require the application of an external insulation blanket to this water heater, pay careful attention to the following so as not to restrict the proper function and operation of the water heater:

- Do not cover the air inlet, flue outlet or operating and warning labels attached to the water heater or attempt to relocate them on the exterior of insulation blanket.

Hot and Cold Pipe Insulation Installation

NOTICE: The hot and cold pipes should be insulated as shown to provide additional freeze protection.

▲ WARNING: In case the pipe insulation is not rated for the appropriate weather conditions install electric heat tracing or equivalent to prevent freezing of the pipes. Do not insulate or block drain valve on the hot outlet fitting. If the pipes are allowed to freeze, the water heater and the pipes may malfunction or leak due to freezing water.

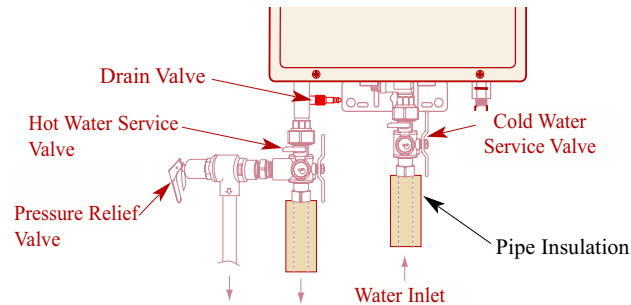

For increased energy efficiency, use pipe insulation. Please install the insulation according to the diagram above, making sure

to insulate all the way to the top. **Do not** cover any drain or pressure relief valve(s).

During Installation of this water heater...

Do's

- Do follow all installation instructions covered in this manual.
- Do check inlet gas pressure to ensure that it is within the range specified on the rating plate.
- Do provide adequate air for combustion and ventilation as discussed in the Use & Care Manual and the National Fuel Gas Code (CAN/CGA B149 in Canada).
- Do maintain proper clearances to combustibles and non-combustibles as specified on the nameplate.
- Do ensure that the venting system complies with the guidelines found in the Use & Care Manual and National Fuel Gas Code (CAN/CGA B149 in Canada).

- Do contact local gas company to ensure gas meter and gas piping are adequately sized.
- Do use teflon tape on water line connections and fittings.

Don'ts

- Don't block or restrict Air Intake Opening located on the front cover of the water heater.
- Don't remove the front cover unless absolutely necessary. This should only be done after being examined by a qualified service technician.
- Don't install this product where standing water may occur.
- Don't use pipe dope on water line connections and fittings.

Installation Check List

A. Outdoor Water Heater Location

- Outdoor water heaters must be installed outdoors.
- Protected from freezing temperatures.

B. Indoor Water Heater Location

- Close to area of vent termination.
- Indoors and protected from freezing temperatures.

C. Outdoor and Indoor Water Heater Location

- Proper clearance from combustible surfaces observed.
- Sufficient fresh air supply for proper operation of water heater.
- Air supply free of corrosive elements and flammable vapors.
- Provisions made to protect area from water damage.
- Sufficient room to service heater.
- Combustible materials, such as clothing, cleaning materials, rags, etc. clear of the heater and vent piping.
- Water heater is properly attached to the wall.

D. Water Supply

- Water supply has sufficient pressure.
- Air purged from water heater and piping.
- Water connections tight and free of leaks.
- Water filter is clean and in place.
- Materials used are as instructed in this manual.
- Water pipes are insulated and protected from freezing.

E. Gas Supply

- Gas type matches rating plate.
- Gas supply pressure is sufficient for the water heater.
- Gas line equipped with shut-off valve, union and sediment trap.
- Approved pipe joint compound used.
- Soap and water solution used to check all connections and fittings for possible gas leak.
- Gas Company inspected installation (if required).

F. Relief Valve

- Pressure Relief Valve properly installed and discharge line run to open drain.
- Discharge line protected from freezing.

G. Venting (Indoor Water Heaters Only)

- Vent pipe material should be category III and meet UL1738 in US and ULC S636 in Canada.
- Vent connector(s) pitched (1/4" per foot of length minimum) DOWNWARD or UPWARD to termination. If UPWARD, a condensate trap must be installed close to the heater. See page 14.
- Vent connector(s) securely fastened together with high temperature silicone (500°F [260°C]) and air-tight.
- All vent runs are properly supported.
- Vent terminal is properly installed.
- Sufficient combustion air is available.
- Maximum and minimum vent lengths are observed.

H. Electrical Wiring

- Voltage matches rating plate.
- Water heater is properly grounded.
- Supply cord and/or wiring meets all local codes.

Operating the water heater:

Safety Precautions

- A** Do turn off manual gas shut-off valve if water heater has been subjected to overheating, fire, flood, physical damage or if the gas supply fails to shut off.
 - B** Do Not turn on water heater unless water and gas supplies are fully opened.
 - C** Do Not turn on water heater if cold water supply shut-off valve is closed.
 - D** Do Not allow combustible materials such as newspaper, rags or mops to accumulate near water heater.
 - E** Do Not store or use gasoline or other flammable vapors and liquids, such as adhesives or paint thinner, in vicinity of this or any other appliance. If such flammables must be used, open doors and windows for ventilation, and all gas burning appliances in the vicinity should be shut off including their pilot lights, to avoid vapors lighting.
- NOTICE: Flammable vapors can be drawn by air currents from surrounding areas to the water heater.**
- F** If there is any difficulty in understanding or following the Operating Instructions or the Care and Cleaning section, it is recommended that a qualified person or serviceman perform the work.

Water Temperature Setting

▲ DANGER: There is a hot water scald potential if the temperature is set too high. Households with small children, disabled or elderly persons may require a 120°F (49°C) or lower temperature setting to prevent contact with HOT water.

The temperature of the water in the water heater can be regulated by setting the temperature on the front of the remote control.

Safety factors should be considered when selecting the water temperature setting of the water heater's remote control.

The remote control was set at 100°F (38°C) before the water heater was shipped from the factory. This is the recommended starting point.

Water temperatures above 125°F (52°C) can cause severe burns or death from scalding.

Be sure to read and follow the warnings outlined in this manual and on the label located on the water heater.

Mixing valves are available for reducing point of use water temperature by mixing hot and cold water in branch water lines. Contact a licensed plumber or the local plumbing authority for further information. (See page 4 for more details.)

The chart below may be used as a guide in determining the proper water temperature for your home.

Time/Temperature Relationship in Scalds

Water Temperature	Time To Produce a Serious Burn
120°F (49°C)	More than 5 minutes
125°F (52°C)	1½ to 2 minutes
130°F (54°C)	About 30 seconds
135°F (57°C)	About 10 seconds
140°F (60°C)	Less than 5 seconds
145°F (63°C)	Less than 3 seconds
150°F (66°C)	About 1½ seconds
155°F (68°C)	About 1 second

Table courtesy of Shriners Burn Institute

Water Temperature Setting...

Maximum water temperature occurs while the burner is on. To determine the water temperature, turn on a hot water faucet and place a thermometer in the water stream. Water temperature at the faucet may vary depending on season and length of pipe from the water heater.

The factory setting of the remote control temperature range is between 100°F (38°C) and 120°F (49°C).

The remote control is factory preset to 100°F (38°C).

To turn the remote control ON or OFF, press the POWER button.

To adjust the temperature to a required setting, press the UP arrow temperature button.

Pressing the UP or DOWN temperature adjustment buttons will change the temperature set point.

The temperature set point on the remote control cannot be increased above 112°F (44°C) when a hot water faucet is in the open position.

Notice: The remote control cannot be turned on when water is flowing or circulating through the water heater.

Notice: The factory setting allows operating temperatures between 100°F (38°C) and 120°F (49°C). Temperatures of up to 140°F (60°C) for Light duty models and up to 180°F (82°C) for Heavy Duty models can be achieved with the MAIN (UMC-117) remote control and a dip switch adjustment. Only qualified service personnel should perform

this adjustment. Only factory authorized remote control(s) should be used.

The hottest temperature water will be at the hot water faucet closest to the water heater.

Always remember to test the water temperature with your hand before use and remember that hotter water increases the risk of scald injury.

Always supervise young children or others who are incapacitated.

The water heater is equipped with a device that will shut off the gas supply to the burner if the water heater exceeds normal operating temperatures. Refer to the “Before You Call For Service” section located near the back of this manual, or contact your dealer.

▲ WARNING: Should overheating occur or the gas supply fail to shut off, turn off the manual gas control valve to the appliance.

If the water heater has been subjected to fire, flood, physical damage, or has been under water, turn off the manual gas shut-off valve(s), and do not operate the water heater again until it has been checked by qualified personnel.

Notice: The water heater may not operate with a small water flow. In such case, increase the water flow. If water heater still does not operate and hot water faucet is completely open, increase the temperature setting on the remote control.

Notice: Display shows °F only.

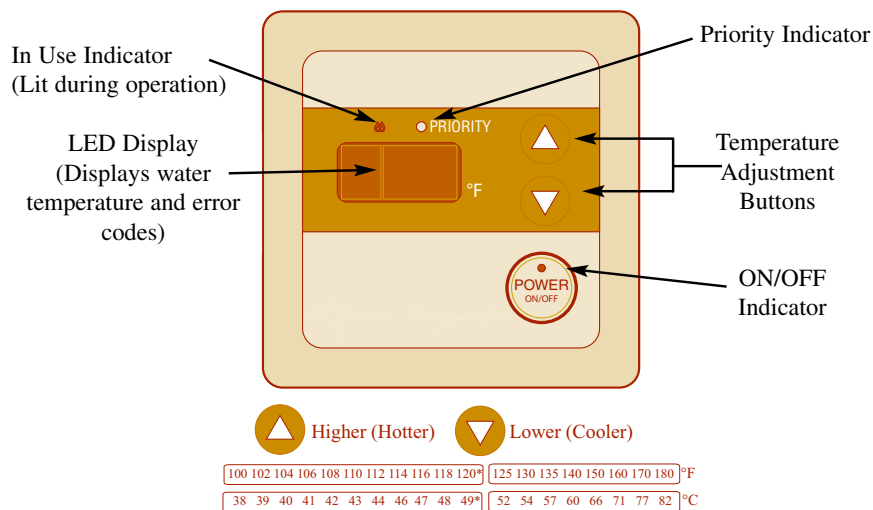

Notice: Only heavy duty water heaters can achieve temperatures up to 180°F (82°C).

* Temperatures above 120°F (49°C) can be achieved by adjusting the dip switch. See page 35 for dip switch adjustment.

Care and cleaning of the water heater:

▲ DANGER: Before manually operating the relief valve, make certain no one will be exposed to the danger of the hot water released by the valve. The water may be hot enough to create a scald hazard. The water should be released into a suitable drain to prevent injury or property damage.

▲ DANGER: Hotter water increases the potential for Hot Water Scalds.

▲ DANGER: Failure to perform the recommended Routine Preventative Maintenance can harm the proper operation of this water heater, which can cause carbon monoxide dangers, excessive hot water temperatures and other potentially hazardous conditions.

Routine Preventative Maintenance

Properly maintained, your water heater will provide years of dependable trouble-free service.

It is recommended that a periodic inspection of the burner, relief valve, air intake filter, water filter and venting system should be made by service personnel qualified in gas appliance repair.

It is suggested that a routine preventive maintenance program be established and followed by the user.

At least once a year, lift and release the lever handle on the pressure relief valve, located in the hot outlet piping of the water heater, to make certain the valve operates freely. Allow several gallons to flush through the discharge line to an open drain.

NOTICE: If the pressure relief valve on the hot water heater discharges periodically, this may be due to a problem in the water system. Contact the water supplier or your plumbing contractor on how to correct this. **DO NOT plug the relief valve outlet.**

Rapid closing of faucets or solenoid valves in automatic water using appliances can cause a banging noise heard in a water pipe. Strategically located risers in the water pipe system or water hammer arresting devices can be used to minimize the problem.

Inspect the area around the water heater to ensure a safe operating environment. Keep appliance area clear and free from combustible materials, gasoline and other flammable vapors and liquids.

Ensure the unit has not been damaged. If damage or denting is present, contact a service personnel to verify proper operation.

Check for any abnormal sounds during normal operation of the water heater.

All piping should be checked for gas and/or water leaks. Refer to page 19 of this manual for instructions on leak testing.

The air intake and cold water supply filters should be cleaned monthly. Refer to the "Housekeeping" section for further information.

DO NOT operate the water heater if you feel something is wrong with the unit.

DO NOT allow children to operate or otherwise handle the unit.

Notice: After inspection, maintenance and/or cleaning, ensure proper operation by turning on a hot water faucet.

Housekeeping

▲ DANGER: Shock Hazard
Make sure the electrical power to the water heater is off to avoid potential serious injury or damage to components.

▲ DANGER: Combustible materials, such as clothing, cleaning materials or flammable liquids, etc., must not be placed against or next to the water heater.

Before performing Housekeeping tasks to this water heater, turn the unit off and disconnect the power supply.

Vacuum around the water heater for dust, dirt and lint on a regular basis.

Clean the water heater and remote control by using a damp soft cloth with a few drops of mild detergent and gently wiping the surfaces of the unit. Wipe any remaining moisture with a dry soft cloth.

To ensure sufficient ventilation and combustion air supply, proper clearances must be maintained.

DO NOT block or obstruct the air intake opening of the water heater. A minimum of 12" (30 cm) is required between this combustion air inlet opening and any obstruction.

The Air Intake and Water filters should be cleaned on a monthly basis.

HOW TO CLEAN THE WATER FILTER:

- Make sure the unit is OFF and the electrical power supply has been disconnected.
- Turn the water supply OFF to the heater.
- **Drain heater. See "Draining The Water Heater" section on page 31.**
- Unscrew the water filter, and slide the filter out.
- **DO NOT** tap the filter as it may deform and/or damage the filter.
- To remove severe sediment and dirt, use a soft brush and wash with running water.
- Return the filter to the water heater and screw in the filter.
- Turn the electrical power supply and cold water supply ON to the water heater.

...cets. Before
...step, make sure that
...g out of all hot water

2 Open the water shut-off
again after making s
out from hot water
remove air from

5 Close the water shut-off valve

6 Using a suitable conta
remove the water filter
a garden hose to the d
the hot water outlet lin

3 Plug into an

⚠ WARNING: Failure
to drain the water
heater can cause serious
damage to the water
heater as well as
personal injury.

Before You Call For Service...



Troubleshooting Tips

Save time and money! Review the charts on the following pages first and you may not need to call for service.

Problem	Possible Cause	What To Do
Not enough or no hot water.	Water Shutoff valve is not fully opened.	● Check shutoff valve and open fully.
	Hot water faucet is not fully opened.	● Open hot water faucet completely. (The main burner goes off when incoming water volume is inadequate.)
	Water piping is frozen.	● Allow piping to thaw.
	No electricity or water supply is cut off.	● Check that proper power is being supplied and/or water supply is adequate.
	Unit is not "ON".	● Turn the unit "ON" by the button on the remote control.
	The temperature may be set too low.	● Increase the temperature setting.
	Mixing Valve Malfunctions (if applicable)	● Check and replace if necessary.
	Error code displayed on remote control.	● See instructions for Error Code and if required, contact a dealer for service.
	Not enough water demand.	● Increase water flow.
	Water inlet filter clogged.	● Clean water inlet filter.
	Fixture aerator is clogged.	● Clean aerator.
	Scale buildup in heat exchanger.	● Check for error code. If required, contact a dealer for service.
	Hot and cold water lines reversed.	● Reverse water connections.
Water not hot enough.	The temperature may be set too low.	● Increase the temperature setting.
	The gas valve is not fully opened.	● Check and open the gas valve fully.
	Gas supply pressure is low.	● Call your gas company to verify the gas meter and gas piping size.
	Bleed over in one of the hot water fixtures.	● Call dealer for service.
Water too hot.	Temperature is set too high.	● Decrease the temperature setting.
	Water shutoff valve is not fully opened.	● Check shutoff valve and open fully.
	Small amount of water has been heated.	● Allow more water to flow.
Fan continues to rotate after hot water faucet is closed.	This function is to supply hot water when the hot water faucet is reopened.	● Normal operation. There is no need to call for service.

⚠ CAUTION: Make certain power to water heater is "OFF" before removing protective cover FOR ANY REASON.

⚠ CAUTION: Label all wires prior to disconnection when servicing controls. Wiring errors can cause improper and dangerous operation. VERIFY PROPER OPERATION AFTER SERVICING.

⚠ CAUTION: For your safety, DO NOT attempt repair of electrical wiring, gas piping, remote control, burners, vent connectors or other safety devices. Refer repairs to qualified service personnel.

Error Code Guide:

When an error code is displayed:

- Close the hot water faucet, turn off the switch on the remote control.
- Wait for about 5 minutes before turning the switch on again.
- Open the hot water faucet.

If the error code remains in the display:

- Close the hot water faucet and turn off the switch on the remote control.
- Take the proper action shown below and attempt operation of the appliance again.

If the error code is still shown:

- Turn off the hot water faucet and turn off the switch on the remote control.
- Take note of the error code displayed and call the customer service assistance number in the "If You Need Service" section of the manual on the back cover.

Notice: If an error code other than those listed below is displayed, immediately turn off the hot water faucet, take note of the error code, turn off the switch on the remote control and call the customer assistance number.

Error Code	Possible Cause	What To Do
11 or 12	The Gas shutoff valve is not opened fully. Gas service has been interrupted. LP Gas is running low. (LP models only). Air in Gas Line. Power supply not grounded. Low inlet gas pressure due to improper sizing Wrong gas type. Improper venting, vent material, or vent configuration.	<ul style="list-style-type: none"> ● Open the Gas shutoff valve fully. ● Contact gas utility company. ● Fill up LP Gas container or replace with a new cylinder of LP Gas. ● Bleed all air from gas lines. ● Ensure appliance is properly grounded. ● Ensure gas line, meter, and regulator are sized properly. ● Ensure gas type is correct. ● Ensure venting is per Use & Care Manual. Contact a dealer for service.
15	The hot water faucet is not opened enough. Water heater has build up of lime deposits.	<ul style="list-style-type: none"> ● Open the faucet more to secure enough volume. ● Contact a dealer for service.
05 or 13 (On error code 05 only: Every 60 seconds you hear an alarm or when the faucet is closed, the alarm stops.) (On error code 13 only: Unit shuts down.) Indoor Water Heater Only	Air intake of the unit and/or vent termination may be blocked. Ventilator or other vents of the room may be blocked. The air inside the room may be contaminated due to long use of a fireplace or spaceheater. Heavy ventilation by other equipment or appliances causing the lack of air intake to the water heater. Air shortage may be caused by too much steam in the unit. Air intake filter is clogged. If the error code is still displayed after taking the above steps.	<ul style="list-style-type: none"> ● Remove any obstructions of the air intake or vent termination. ● Clean the air intake of any dust or grease buildup. ● Open a window or vent to keep the air inside the room fresh. ● Lower the level of the ventilation of other equipment or appliances. ● Avoid direct contact from steam. ● Clean the air intake filter. ● Please contact a dealer for service.
1L	Water heater has buildup of lime deposits.	<ul style="list-style-type: none"> ● Contact a dealer for service.
99 Outdoor Water Heater Only	Decrease of blower motor ventilation volume. (Operation Stops)	<ul style="list-style-type: none"> ● Clean any blockage from heat exchanger fins and/or blower motor

⚠ CAUTION: Make certain power to water heater is "OFF" before removing protective cover FOR ANY REASON.

⚠ CAUTION: Label all wires prior to disconnection when servicing controls. Wiring errors can cause improper and dangerous operation. VERIFY PROPER OPERATION AFTER SERVICING.

⚠ CAUTION: For your safety, DO NOT attempt repair of gas piping, remote control, burners, vent connectors or other safety devices. Refer repairs to qualified service personnel.

Required adjustment for up to 140°
(82°C) for Heavy Duty water heater

WARNING: Refer to scald potential
during adjustment. Changing this setting
the #4 DIP Switch if the
it is det

tem. The LED of
display of the Mai
over.
rol, gas and wat
operation and pe

T

r

IF YOU NEED SERVICE



1. Should you have any questions about your new water heater, or if it requires adjustment, repair, or routine maintenance, it is suggested that you first contact your installer, plumbing contractor or previously agreed upon service agency. In the event the firm has moved, or is unavailable, refer to the telephone directory, commercial listings or local utility for qualified service assistance.
2. Should your problem not be solved to your complete satisfaction, you should then contact the Manufacturer's National Service Department at the following address:
2600 Gunter Park Drive
Montgomery, Alabama 36109-1413
Phone: 1-800-432-8373.

When contacting the manufacturer, the following information will be requested:

- a. Model and serial number of the water heater as shown on the rating plate attached to the front panel of the heater.
- b. Address where the water heater is located and physical location.
- c. Name and address of installer and any service agency who performed service on the water heater.
- d. Date of original installation and dates any service work was performed.
- e. Details of the problem as you can best describe them.
- f. List of people, with dates, who have been contacted regarding your problem.

Important Instructions for the Commonwealth of Massachusetts

The Commonwealth of Massachusetts requires compliance with regulation 248 CMR 4.00 and 5.00 for installation of through – the – wall vented gas appliances as follows:

(a) For all side wall horizontally vented gas fueled equipment installed in every dwelling, building or structure used in whole or in part for residential purposes, including those owned or operated by the Commonwealth and where the side wall exhaust vent termination is less than seven (7) feet above finished grade in the area of the venting, including but not limited to decks and porches, the following requirements shall be satisfied:

1. **INSTALLATION OF CARBON MONOXIDE DETECTORS.** At the time of installation of the side wall horizontal vented gas fueled equipment, the installing plumber or gasfitter shall observe that a hard wired carbon monoxide detector with an alarm and battery back-up is installed on the floor level where the gas equipment is to be installed. In addition, the installing plumber or gasfitter shall observe that a battery operated or hard wired carbon monoxide detector with an alarm is installed on each additional level of the dwelling, building or structure served by the side wall horizontal vented gas fueled equipment. It shall be the responsibility of the property owner to secure the services of qualified licensed professionals for the installation of hard wired carbon monoxide detectors

a. In the event that the side wall horizontally vented gas fueled equipment is installed in a crawl space or an attic, the hard wired carbon monoxide detector with alarm and battery back-up may be installed on the next adjacent floor level.

b. In the event that the requirements of this subdivision can not be met at the time of completion of installation, the owner shall have a period of thirty (30) days to comply with the above requirements; provided, however, that during said thirty (30) day period, a battery operated carbon monoxide detector with an alarm shall be installed.

2. **APPROVED CARBON MONOXIDE DETECTORS.** Each carbon monoxide detector as required in accordance with the above provisions shall comply with NFPA 720 and be ANSI/UL 2034 listed and IAS certified.

3. **SIGNAGE.** A metal or plastic identification plate shall be permanently mounted to the exterior of the building at a minimum height of eight (8) feet above grade directly in line with the exhaust vent terminal for the horizontally vented gas fueled heating appliance or equipment. The sign shall read, in print size no less than one-half (1/2)" in size, "GAS VENT DIRECTLY BELOW. KEEP CLEAR OF ALL OBSTRUCTIONS".

4. **INSPECTION.** The state or local gas inspector of the side wall horizontally vented gas fueled equipment shall not approve the installation unless, upon inspection, the inspector observes carbon monoxide detectors and signage installed in accordance with the provisions of 248 CMR 5.08(2)(a)1 through 4.

(b) **EXEMPTIONS:** The following equipment is exempt from 248 CMR 5.08(2)(a)1 through 4:

1. The equipment listed in Chapter 10 entitled "Equipment Not Required To Be Vented" in the most current edition of NFPA 54 as adopted by the Board; and

2. Product Approved side wall horizontally vented gas fueled equipment installed in a room or structure separate from the dwelling, building or structure used in whole or in part for residential purposes.

(c) **MANUFACTURER REQUIREMENTS - GAS EQUIPMENT VENTING SYSTEM PROVIDED.** When the manufacturer of Product Approved side wall horizontally vented gas equipment provides a venting system design or venting system components with the equipment, the instructions provided by the manufacturer for installation of the equipment and the venting system shall include:

1. Detailed instructions for the installation of the venting system design or the venting system components; and

2. A complete parts list for the venting system design or venting system.

(d) **MANUFACTURER REQUIREMENTS - GAS EQUIPMENT VENTING SYSTEM NOT PROVIDED.** When the manufacturer of a Product Approved side wall horizontally vented gas fueled equipment does not provide the parts for venting the flue gases, but identifies "special venting systems", the following requirements shall be satisfied by the manufacturer:

1. The referenced "special venting system" instructions shall be included with the appliance or equipment installation instructions; and

2. The "special venting systems" shall be Product Approved by the Board, and the instructions for that system shall include a parts list and detailed installation instructions.

(e) A copy of all installation instructions for all Product Approved side wall horizontally vented gas fueled equipment, all venting instructions, all parts lists for venting instructions, and/or all venting design instructions shall remain with the appliance or equipment at the completion of the installation.

Free Manuals Download Website

<http://myh66.com>

<http://usermanuals.us>

<http://www.somanuals.com>

<http://www.4manuals.cc>

<http://www.manual-lib.com>

<http://www.404manual.com>

<http://www.luxmanual.com>

<http://aubethermostatmanual.com>

Golf course search by state

<http://golfingnear.com>

Email search by domain

<http://emailbydomain.com>

Auto manuals search

<http://auto.somanuals.com>

TV manuals search

<http://tv.somanuals.com>