

RICCAR®

RADIANCE
Owner's Manual



Important Safety Instructions	2
Polarization Instructions.....	3
Description of the Vacuum.....	4
Before Using Your Radiance for the First Time	6
Operation	
Unwinding the Power Cord.....	7
Vacuuming Carpet.....	8
Vacuuming Hard Surfaces.....	8
Brushroll Auto Shut-off Feature.....	8
Dirt Sensing Display	9
Carpet Height Adjustment	9
Vacuuming Under Furniture.....	10
Carrying the Vacuum.....	11
Attachment Cleaning	
Wand Cleaning.....	12
Cleaning Tools.....	13
Adjusting the Suction Power.....	15
Optional Hose Extension.....	16
Disconnecting the Hose.....	16
Maintenance and Care	
When to Change the Vacuum Bag.....	17
Replacing the Vacuum Bag.....	18
When to Change the Filters.....	19
Replacing the Filters.....	19
Cleaning the Dirt Sensor Eye.....	21
Lifetime Belt Warranty.....	21
Annual Checkup Reminder.....	21
Problem Solving Guide	
Full Bag or Clog Indicator Light.....	22
Change Filter Indicator Light	22
Jammed Brushroll.....	23
Thermal Motor Protection.....	23
Troubleshooting.....	24
How to Contact Your Authorized Retailer.....	24
Visit Riccar Online.....	24
Warranty	25

IMPORTANT SAFETY INSTRUCTIONS

When using an electrical appliance, basic precautions should always be followed, including the following:

READ ALL INSTRUCTIONS BEFORE USING THIS APPLIANCE

WARNING: The manufacturer cannot accept responsibility for damage caused when the appliance is not used according to the instructions or for uses other than those for which it was intended.

To reduce the risk of fire, electric shock or injury:

- Do not leave appliance when plugged in. Unplug from outlet when not in use and before servicing.
- Do not handle plug or appliance with wet hands.
- WARNING: ELECTRIC SHOCK COULD OCCUR IF USED OUTDOORS OR ON WET SURFACES.
- Do not put any object into openings. Do not use with any opening blocked; keep free of dust, lint, hair and anything that may reduce air flow.
- Do not allow to be used as a toy. Close attention is necessary when used by or near children.
- Keep hair, loose clothing, fingers and all parts of body away from openings and moving parts.
- Use only as described in this manual. Use only manufacturer's recommended attachments.
- Do not pick up anything that is burning or smoking, such as cigarettes, matches or hot ashes.
- Do not use with damaged cord or plug. If appliance is not working as it should, has been dropped, damaged, left outdoors, or dropped into water, return it to your Authorized Retailer for service.
- Do not use without vacuum bag and/or filters in place.
- Turn off all controls before unplugging.
- Use extra care when cleaning on stairs.
- Do not pull or carry by cord, use cord as a handle, close a door on the cord, or pull cord around sharp edges or corners. Do not run appliance over cord. Keep cord away from heated surfaces.
- Do not use to pick up flammable or combustible liquids such as gasoline or use in areas where they may be present.
- Do not unplug by pulling on cord. To unplug, grasp the plug, not the cord.
- Do not attempt to service the unit while appliance is plugged in.

SAVE THESE INSTRUCTIONS.

Polarization Instructions

POWER CORD, 2-WIRE POLARIZED CORD

Household models: RAD & RADP

To reduce the risk of electric shock, this product is equipped with a polarized alternating current line plug (a plug having one blade wider than the other). This plug will fit into the power outlet only one way. This is a safety feature. If you are unable to insert the plug fully into the outlet, try reversing the plug. If the plug should still fail to fit, contact a qualified electrician to replace the obsolete outlet. Do not defeat the safety purpose of the polarized plug.

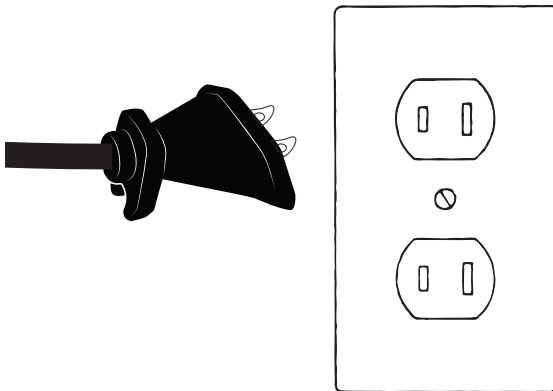

State of California Proposition 65 Warnings:

WARNING: This product contains one or more chemicals known to the State of California to cause cancer.

WARNING: This product contains one or more chemicals known to the State of California to cause birth defects or other reproductive harm.

Description of the Vacuum

- 1 DeluxeTouch™ Handle
- 2 Main On/Off Power Switch
- 3 Carpet/Hardwood Floor Switch
- 4 40' Power Cord
- 5 Carrying Handle
- 6 Bag Compartment Latch (to Replace Vacuum Bag)
- 7 Exhaust Filter Cover
- 8 Vacuum Nozzle
- 9 Change Filter Indicator
- 10 Full Bag/Clog Indicator
- 11 Brushroll Jam Indicator
- 12 Twin LED Headlamps
- 13 Furniture Guard
- 14 Quick Release Cord Hook
- 15 Deluxe Dusting Brush
- 16 Fast Task™ Tools
- 17 Combination Dusting/Upholstery Tool
- 18 Tool Activation Dial
- 19 5-to-1 Stretch Hose
- 20 Hose Disconnect Cuff
- 21 Handle Release Pedal
- 22 Carpet Height Adjustment Dial
- 23 Thermal Reset Button
- 24 Crevice Tool
- 25 Telescopic Wand
- 26 Wand Extension Collar
- 27 Wand Release Button

Before Using Your Radiance for the First Time

Attaching the Handle to the Vacuum

- Remove the handle screw located on the back of the vacuum. Insert the handle downward into the body of the vacuum. Insert screw and tighten.
- Open bag compartment lid to ensure vacuum bag is in place.
- Your vacuum is now ready for use.

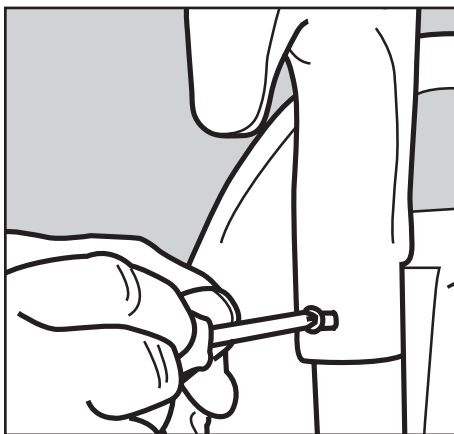
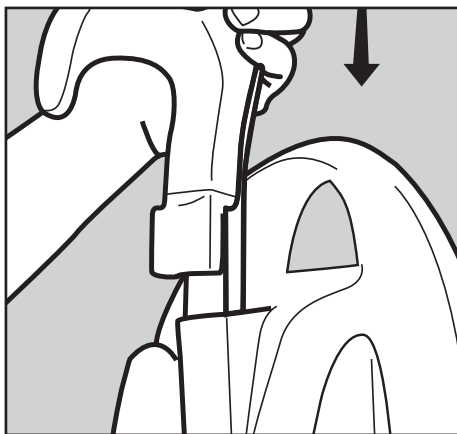
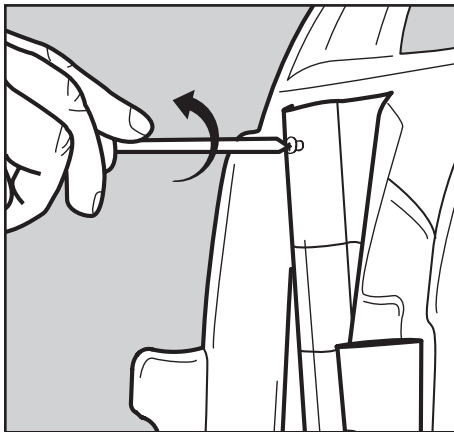

Unwinding the Power Cord

- The upper cord hook rotates to allow for quick access to the power cord.

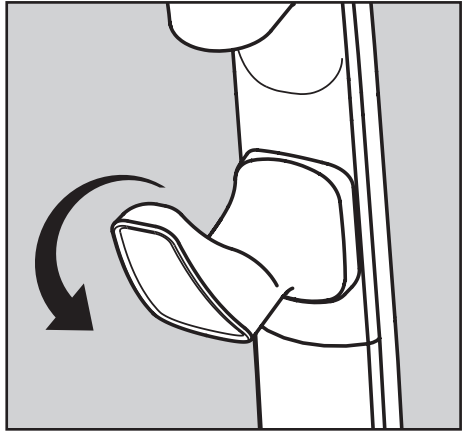

Operation

Vacuumping Carpet

- For carpet cleaning, press the “On/Off” switch on and press the “Carpet” switch on. Both lights should be lit.

Vacuumping Hard Surfaces

- For bare floor cleaning (i.e. tile, wood, or linoleum), turn the main “On/Off” button on and the “Carpet” switch to “Floor”. Only the “On/Off” button light should be on.

Brushroll Auto Shut-off Feature

Note: When the Radiance is turned on and in the upright position, the brushroll will not spin as to eliminate the possibility of damage to floor surfaces. The brushroll will spin when the handle is lowered, provided the “Carpet” switch is on.

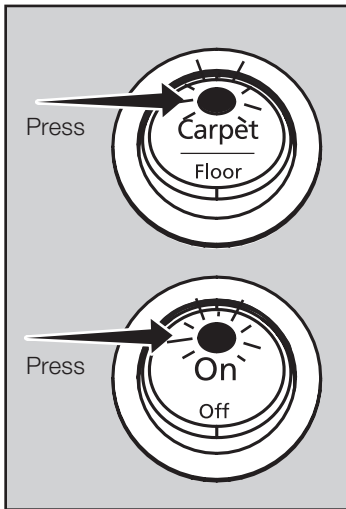

Carpet Cleaning

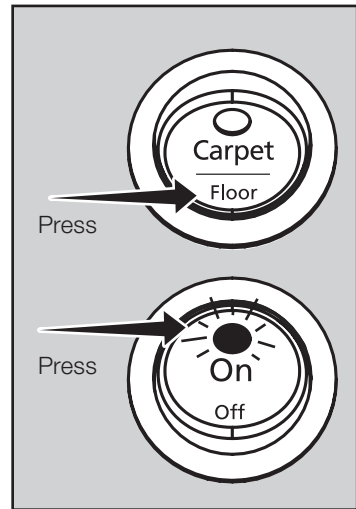

Bare Floor Cleaning
(Wood, Tile, etc.)

Dirt Sensing Display (RADP model only)

The Premium Radiance is equipped with two amber lights that illuminate the edges of the cleaning path when your vacuum detects that dirt is being picked up by the machine (while in the carpet cleaning mode). Continue vacuuming this area until the amber lights no longer illuminate.

When only the white headlights are illuminated, the Premium Radiance has removed all of the deeply embedded dirt from your carpet, and you should move on to a new area.

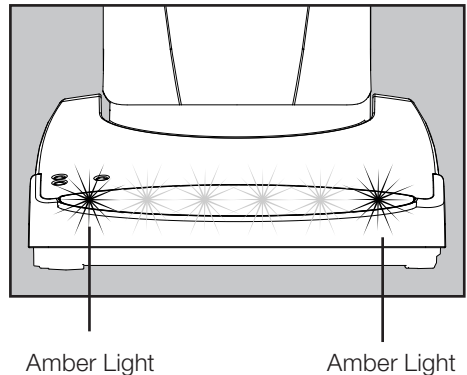

Carpet Height Adjustment

There are six carpet height settings available for cleaning various flooring surfaces.

- Locate the height adjustment dial just above the right rear wheel, and rotate the dial to the desired height.

Max	Shag/Frieze or similar length carpet
X Hi	Plush carpet
High	Medium pile carpet
Auto	General setting
Floor	Hard floors
Low	Low pile carpet

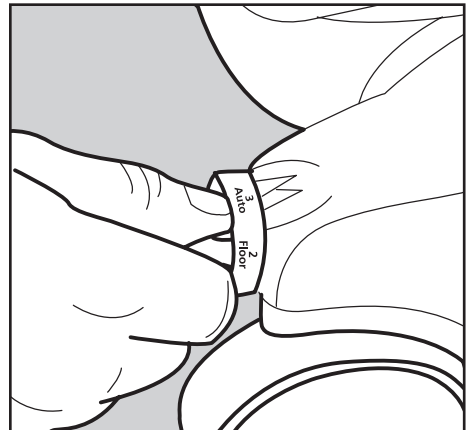

- If it becomes difficult to push the vacuum across the carpet, adjust the dial to a higher carpet setting.

Operation

Vacuuming Under Furniture

Your Riccar Radiance will lay flat on the floor for effective cleaning under beds and tables.

- Press the Handle Release Pedal once for normal vacuuming.
- Press the Handle Release Pedal a second time to enable the vacuum to lay flat on the floor.

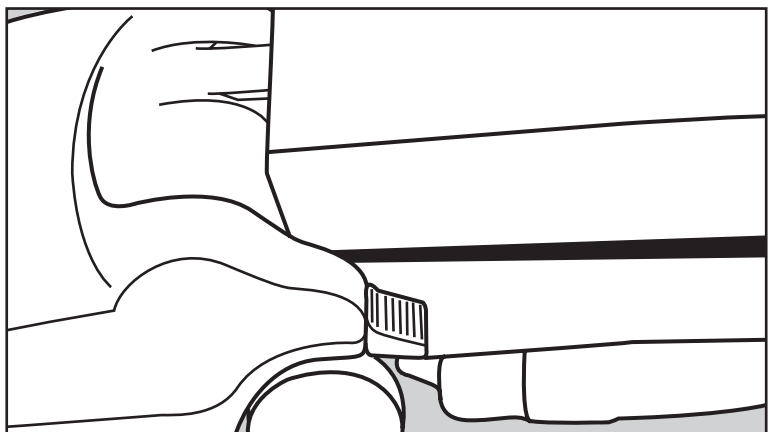
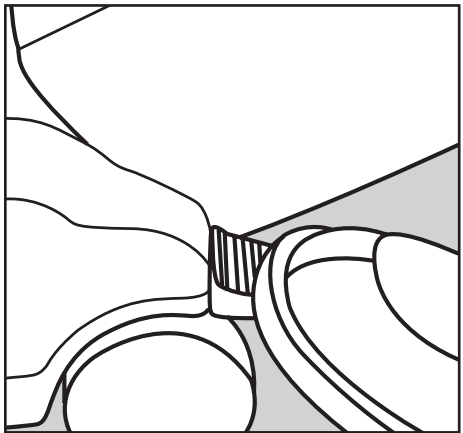
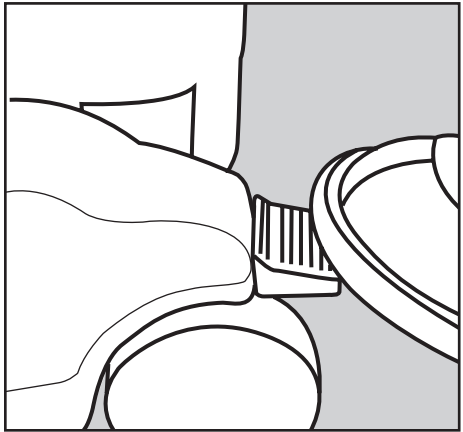

Carrying the Vacuum

To safely transport your vacuum, especially when carrying the vacuum up and down stairs, use the ergonomic Carry Handle.

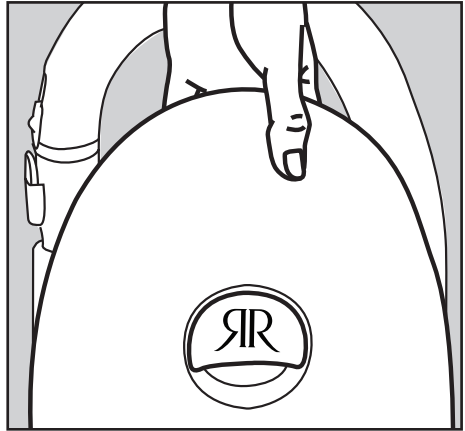

Attachment Cleaning

Wand Cleaning

With the on-board cleaning tools and vacuum wand, your Riccar Radiance becomes a comprehensive cleaning system. Included with your vacuum is an upholstery tool, dusting brush, crevice tool, telescopic wand and a 5-to-1 stretch hose.

- To use the cleaning tools, lift the Telescopic Wand straight up from the vacuum. Turn the Tool Activation Dial to the "Tools On" position. The wand is now activated for quick cleaning.
- Extend the Telescopic Wand by grasping the Wand Extension Collar and pushing outward.
- Attach any of the on-board tools to the end of the Telescopic Wand.
- When finished with tool/wand cleaning, turn the Tool Activation Dial to the "Tools Off" position. Insert the wand back into the vacuum and secure the wand by pushing the curved handle into the holder.

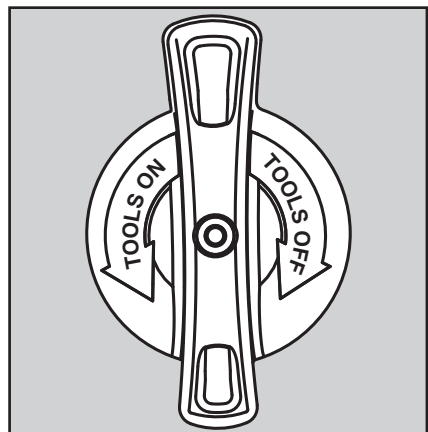
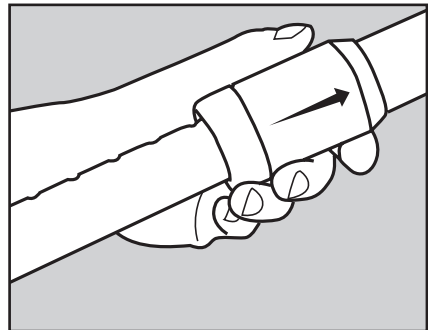
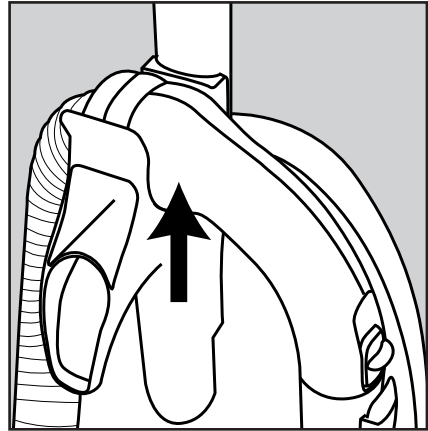

Attachment Cleaning

Cleaning Tools

Your vacuum is equipped with a deluxe dusting brush, upholstery tool and crevice tool. Other tools are available at your Authorized Riccar Retailer.

- Remove the Telescopic Wand from the vacuum and turn the Tool Activation Dial to the "Tools On" position. (See page 12)
- Insert any of the tools onto the end of the wand.

Dusting Brush:

Ideal for tabletops, shelves, blinds or hard surface floors.

Upholstery Tool:

Ideal for soft surfaces like chairs and couches. Remove the dusting brush clip for upholstery cleaning.

Crevice Tool:

Ideal for tight places like between seat cushions or corners.

Deluxe Dusting Brush:

Conveniently converts from a deluxe dusting brush to a deluxe upholstery tool.

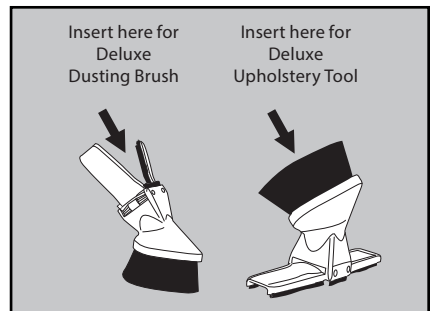
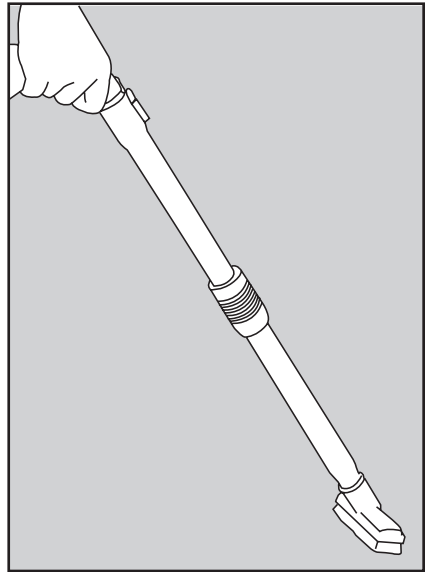

Deluxe Dusting Brush

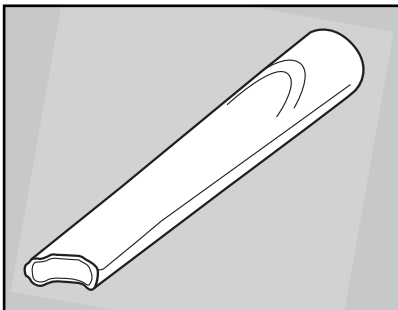

Crevice Tool

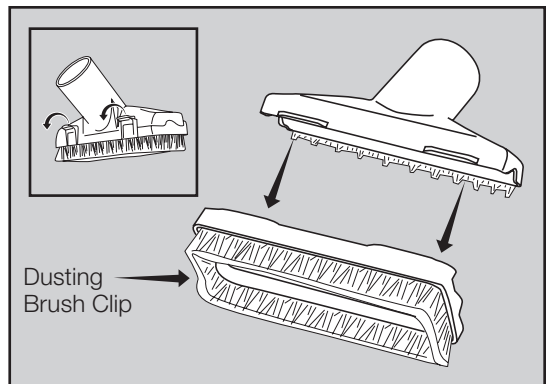

Upholstery Tool

Attachment Cleaning

Cleaning Tools continued...

Cleaning tools can also be attached to the curved handle for above-floor cleaning.

- Disconnect the Telescopic Wand from the curved handle by pressing the Wand Release Button.
- Attach any of the cleaning tools directly to the curved handle.

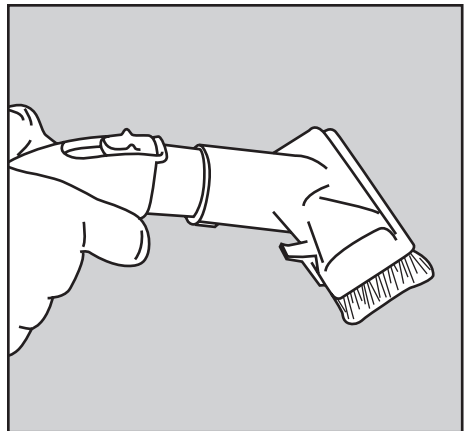
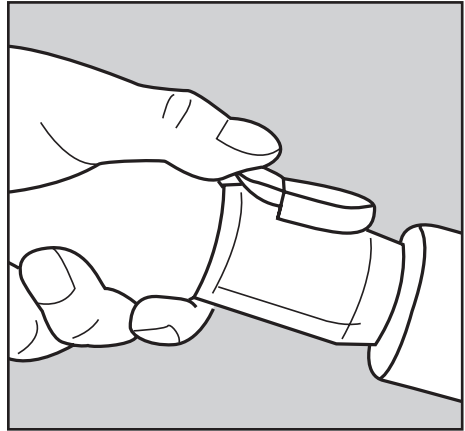

Adjusting the Suction Power for Tool Cleaning

Full suction power might be too strong for some cleaning situations. For example, reduced suction power would be appropriate for cleaning sheer curtains.

- On the curved handle, locate the Suction Relief Valve and slide it backward. This reduces the suction power coming through the tool. Slide the valve forward when finished to restore full suction power.

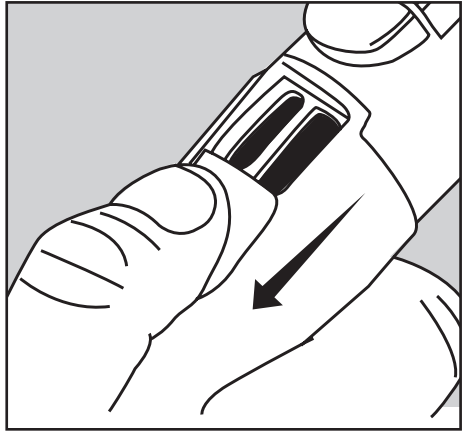

Optional Hose Extension (RTAE)

In order to gain another six feet of tool cleaning reach, a small section of stretch hose can be spliced into the current hose arrangement with the optional Hose Extension Kit available only through your Authorized Riccar Retailer.

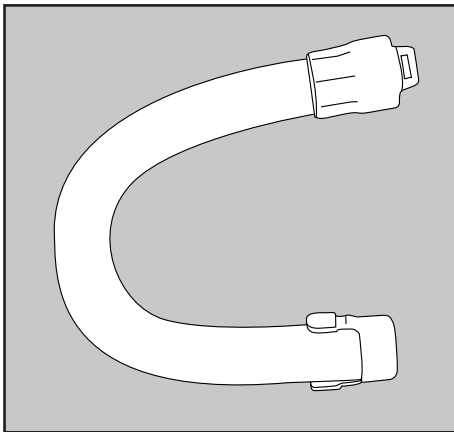

Disconnecting the Hose for Attachment Cleaning

To attach the longer hose from an optional attachment kit, disconnect the hose from the back of the vacuum by pressing the two buttons on the sides of the Hose Disconnect Cuff. Then plug the longer hose into this port.

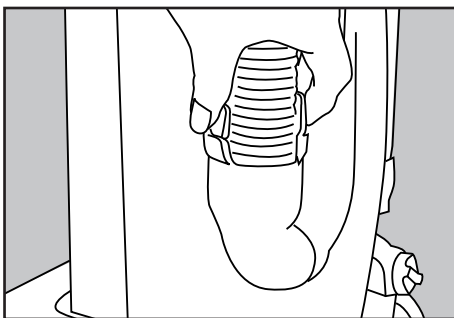

When to Change the Vacuum Bag

The full bag indicator light is designed to show when the bag is full or when there is a clog in the vacuum.

The system measures airflow and alerts the user when airflow is significantly reduced—most commonly from full bags and clogs.

The light could also come on when vacuuming fine powders such as flour or drywall dust. These materials can quickly block the bag pores, significantly reducing airflow before the bag appears to be full. The vacuum bag should still be changed.

Note: The vacuum bags are disposable and intended to only be used once. Do not attempt to reuse. Suction and filtration performance would be greatly reduced.

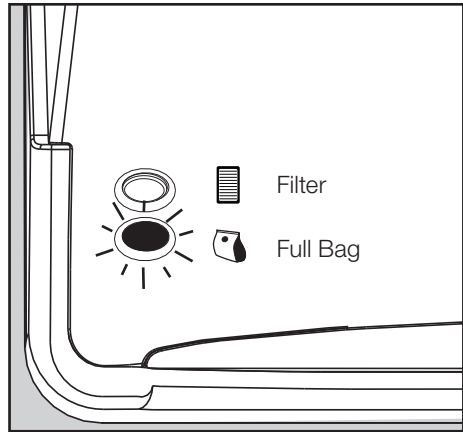

Yellow Warning Light

Maintenance and Care

Replacing the Vacuum Bag

- Open the bag compartment lid.
- Remove vacuum bag by pressing the bag tab.
- To insert a new bag, place the base of the bag collar on the bag supports. Then secure the top of the bag collar with the bag tab.
- Tuck the bag corners into the vacuum before replacing the bag compartment lid.
- Close lid and press latch back into place.

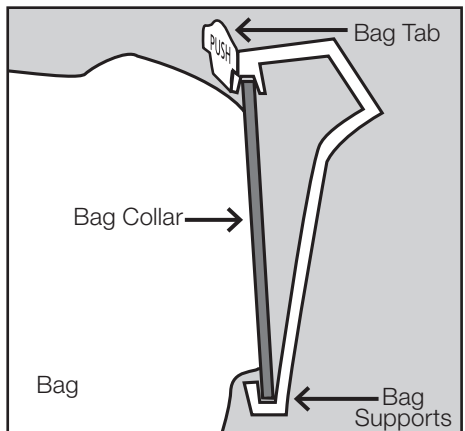
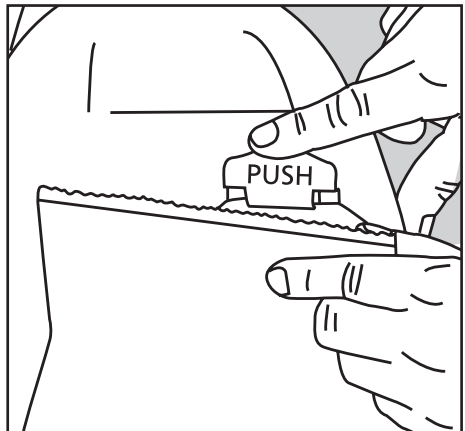
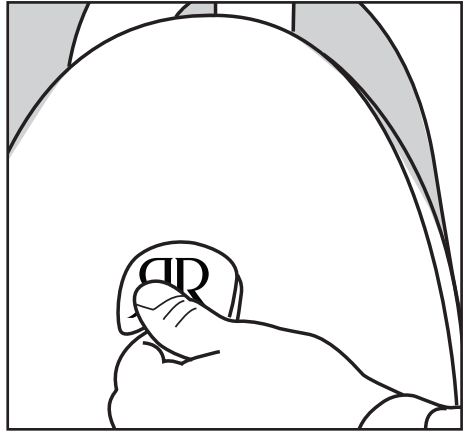

When to Change the Filters

The filters on your Radiance vacuum should be replaced after 25 hours of operation. The Radiance is equipped with a filter clock to monitor the actual hours of operation and will illuminate the change filter indicator light on the nozzle of your vacuum when 25 hours of operation have elapsed.

Note: When the filters are replaced, reset the filter clock (while the vacuum is running) by removing the cap located above the direct air motor filter and pressing the reset button. The change filter indicator light will once again only illuminate after the next 25 hours of operation.

Please Remove Cap And Press Reset Button When Replacing Filter. →

Replacing the HEPA Media Exhaust Filter

Note: Your vacuum is equipped with either the standard HEPA media filter or the HEPA media Plus filter. To avoid confusion when purchasing your filter, the item number is located on the side of the filter. Please give this number to your Authorized Riccar Retailer when purchasing filters or bring your filter holder with you when purchasing new filters.

- Access the filter by pressing down on the release button located on top of the filter holder.
- Remove the used filter and replace with a new filter. **Note: HEPA media filters cannot be washed and reused.**

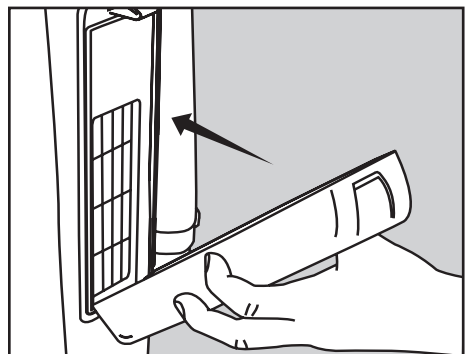
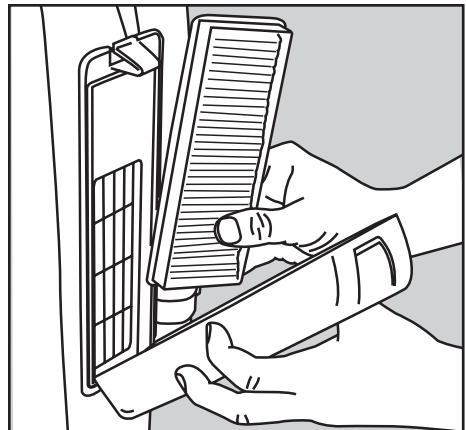
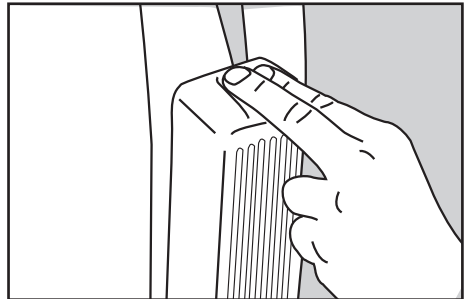
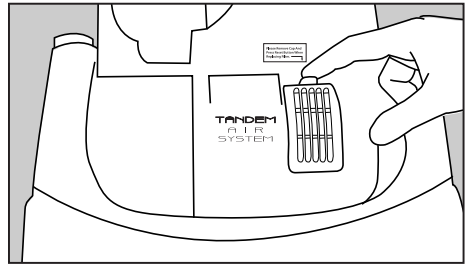

Maintenance and Care

Replacing the HEPA Media Exhaust Filter cont.

- Re-attach the exhaust filter holder to the vacuum by aligning the slot at the base of the filter holder with the clip on the vacuum and press firmly into place.

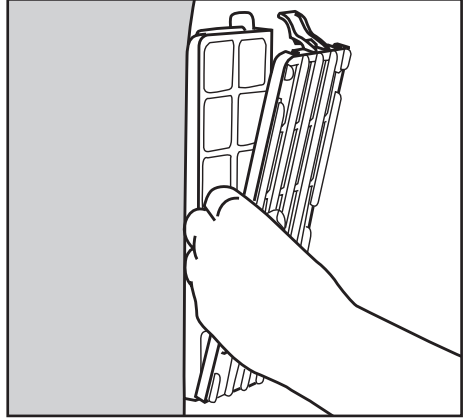

Replacing the Charcoal Filter (RAD model only)

- Open the bag compartment lid and locate the charcoal filter on the left side of the compartment.
- Using the latch on top, remove the charcoal filter holder.
- Remove and throw away the used filter.
- Insert new charcoal filter and snap the charcoal filter holder back into place.
- Replace the bag compartment lid.

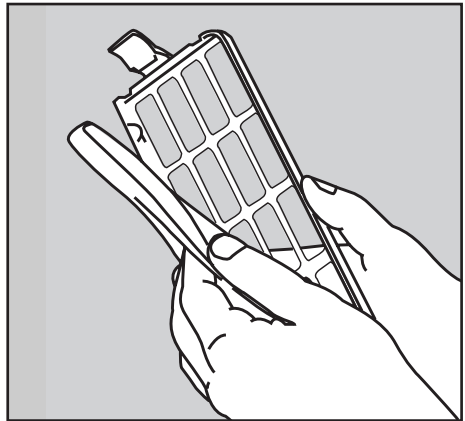

Replacing the Granulated Charcoal Filter (RADP model only)

- Open the bag compartment lid and locate the granulated charcoal filter cartridge on the left side of the compartment.
- Using the latch on top, remove the charcoal filter cartridge. Throw away the entire cartridge.
- Insert a new charcoal filter cartridge and snap back in place into the left side of the vacuum compartment. Replace the bag compartment lid.

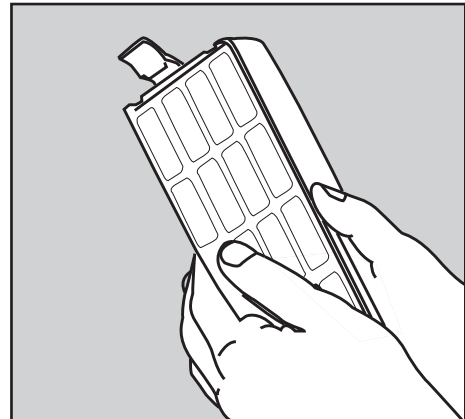

Maintenance and Care

Replacing the Direct Air Motor Filter

- Press the Handle Release Pedal with your foot, and tilt the handle back until it stops. Press the pedal again to lower the handle to the floor.
- Pull the black filter cover latch to access the filter.
- Remove and discard the used filter.
- Insert new direct air motor filter and snap the filter cover back into place.
- Return vacuum handle to its upright position.

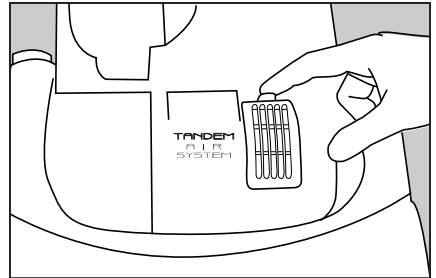
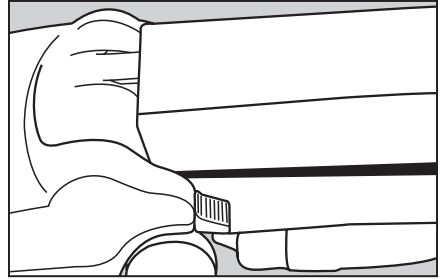

Cleaning the Dirt Sensor Eye

If the amber lights run continuously, it may be the dirt sensor eye has become coated with moist dirt. To remedy this situation, simply vacuum up a small amount of uncooked rice which works to clean the eye. Repeat, if necessary. If the problem persists, contact your Authorized Retailer.

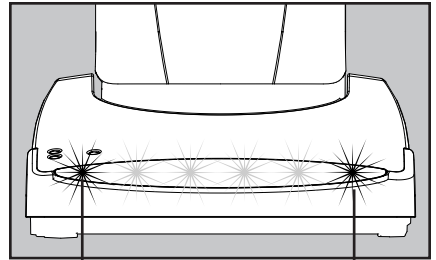

Amber Light

Amber Light

Lifetime Belt Protection Warranty

Your vacuum belt is covered with a lifetime warranty. Should the vacuum belt break, simply bring your vacuum or the broken belt to your Authorized Riccar Retailer for a free replacement.

Annual Checkup Reminder

To keep your vacuum in peak operating condition, it is recommended you bring your vacuum to your Authorized Riccar Retailer for an annual checkup. Your Retailer will conduct a comprehensive examination to ensure your vacuum is in top operating condition.

Problem Solving Guide

Full Bag or Clog Indicator Light

The full bag indicator light is designed to show when the bag is full or when there is a clog in the vacuum.

The system measures airflow and alerts the user when airflow is significantly reduced—most commonly from full bags and clogs.

The light could also come on when vacuuming fine powders such as flour or drywall dust. These materials can quickly block the bag pores, significantly reducing airflow before the bag appears to be full. The vacuum bag should still be changed.

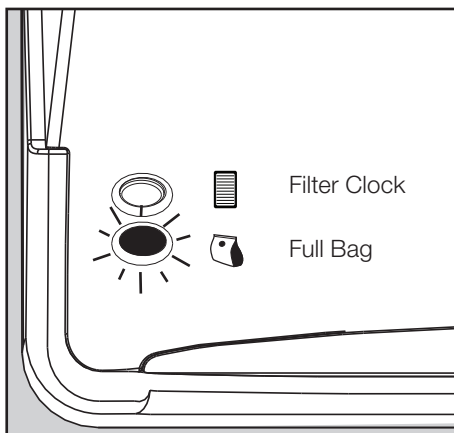

Yellow Warning Light

Change Filter Indicator Light

The filters on your Radiance vacuum should be replaced after 25 hours of operation. The Radiance is equipped with a filter clock to monitor the actual hours of operation and will illuminate the change filter indicator light on the nozzle of your vacuum when 25 hours of operation have elapsed.

When the filters are replaced, reset the filter clock (while the vacuum is running) by removing cap and pressing the reset button when replacing filter. The change filter indicator light will once again only illuminate after the next 25 hours of operation.

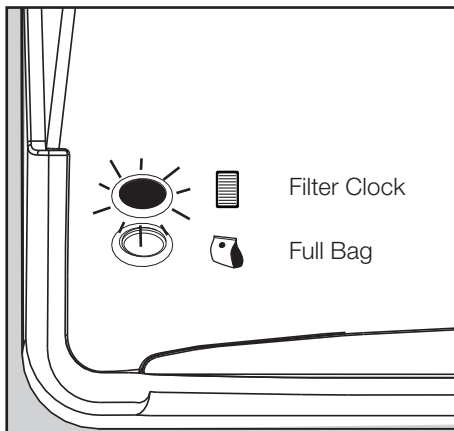

Blue Warning Light

Jammed Brushroll

If an object, such as a throw rug or article of clothing is ever picked up into your vacuum, the vacuum will sense this “jammed brushroll” condition and turn off the brushroll. When this happens, the “brushroll warning” light on the top of the nozzle will light up in red.

- Turn off the vacuum and remove the cause of the jam. Turn vacuum back on. If the brushroll is free of any object and the “brushroll warning” light is still lit, it’s likely the clogged condition is located in the vacuum motor fan. If so, please take your Radiance to your Authorized Riccar Retailer for service.

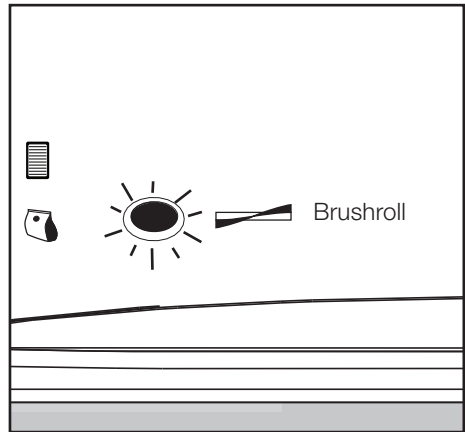

Red Warning Light

Thermal Motor Protection

Your Radiance is equipped with a safeguard to recognize when the vacuum heats up and shuts down to protect your vacuum cleaner. Note that when this happens, the headlamps are still on but the motors shut off. Common reasons why a vacuum may overheat include operating a vacuum with a full bag or when there is a clog in the vacuum.

- Unplug the vacuum.
- Inspect your vacuum for a full bag condition or a hose clog and correct the problem. Locate the Thermal Motor Reset button on the back of the vacuum. Press button and resume vacuuming. If the problem continues, contact your Authorized Riccar Retailer.

Thermal Reset

1. Unplug machine	3. Correct problem
2. Locate problem source (clogged hose or full bag)	4. Press reset button

If problem persists, consult owner's manual or contact retailer.

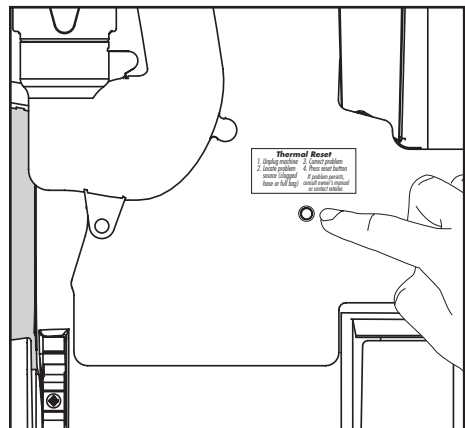

Problem Solving Guide

Troubleshooting

WARNING! To Reduce the Risk of Electrical Shock or Injury From Moving Parts, Unplug Before Servicing or Cleaning.

CAUTION! To reduce the risk of electric shock, do not handle plug or appliance with wet hands.

PROBLEM	POSSIBLE REASON	POSSIBLE SOLUTION
Vacuum won't turn on	<ul style="list-style-type: none">• Power cord not firmly plugged in• Blown fuse or tripped breaker• Needs service	<ul style="list-style-type: none">• Plug unit in firmly• Check house fuse or breaker. Replace fuse / reset breaker• Take to Authorized Retailer
Vacuum won't pick up or low suction	<ul style="list-style-type: none">• "Carpet" switch not on• Vacuum bag full• Clogged filter• Hose clogged• Worn brush strips• Broken belt• Tool activation dial turned on	<ul style="list-style-type: none">• Turn "carpet" switch on• Install new bag• Install new filter• Remove obstacle• Replace brush strips• Take to Authorized Retailer for belt replacement• Turn tool activation dial to "off" position
Dust escaping from vacuum	<ul style="list-style-type: none">• Dust cover not seated properly• Filter not installed correctly• Vacuum bag not installed correctly	<ul style="list-style-type: none">• Reinsert the dust cover and secure latch• Review filter installation (page 20)• Review bag installation (page 19)

Any other service should be done by an Authorized Riccar Vacuum Retailer.
To locate your nearest service center, visit our website at **www.Riccar.com**.
For telephone customer support please call **1-888-6-RICCAR**.

Key Replacement Parts

- Genuine HEPA Media Vacuum Bags: RXH-6
- Genuine Filters: RF9-1 (RAD only), RF9G-1 (RADP only)

What is Covered:

This warranty covers any defects in material and workmanship in your new Riccar Radiance vacuum.

How Long Coverage Lasts:

Warranty coverage for your Riccar vacuum lasts eight years for household use. Radiance Household Vacuum Cleaners used professionally are only warranted for ninety days.

What is Not Covered:

- Damage to the vacuum which occurs from neglect, abuse, alterations, accident, misuse, or improper maintenance.
- Normal replacement items: disposable bags, disposable filters and agitator brushes.
- Damage associated with or resulting from the use of non-genuine parts including normal replacement items.

What Riccar Vacuums Will Do:

This warranty provides, at no cost to you, all labor and parts to keep this vacuum in correct operating condition during the warranted period.

How to Get Service:

Warranty service can only be obtained by presenting the vacuum to an Authorized Riccar Retailer. A proof-of-purchase and product serial number will be required before service is rendered.

To locate your nearest Riccar Retailer, please call 1-888-6-RICCER or visit the Riccar website at www.Riccar.com.

THIS WARRANTY IS EXCLUSIVE AND IN LIEU OF ANY AND ALL OTHER WARRANTIES WHETHER WRITTEN, ORAL, EXPRESSED OR IMPLIED (INCLUDING ANY WARRANTY OF MERCHANTABILITY OR FITNESS FOR A PARTICULAR PURPOSE). THIS WARRANTY DISCLAIMS LIABILITY FOR INCIDENTAL, OR CONSEQUENTIAL DAMAGES.

How State Law Applies:

This warranty gives you specific legal rights, and you may also have other rights which vary from state to state.

Owner's Information

(keep this for your records)

The model and serial number of this product may be found on the back side of the unit. You should note the model and serial number of your unit in the spaces provided below, and retain this book as a permanent record of your purchase.

Date of purchase _____

Serial number _____

Model number _____

Purchased from:

Store name _____

Address _____

City, State, Zip _____

Telephone _____

For Best Performance:

- Keep your vacuum clean and in good operating condition.
- Change vacuum bags once a month or when the full bag indicator changes from green to red to maximize cleaning performance.
- Always use genuine vacuum bags and replacement parts. Use of other products may result in poor cleaning performance, potential vacuum cleaner damage and may void vacuum warranty. Genuine products are designed for maximum cleaning performance.
- Have your vacuum checked periodically by your Authorized Riccar Vacuum Retailer.
- Use only Authorized Riccar Vacuum Retailers for parts or service.
- Store your vacuum carefully in a dry area.
- For optimum cleaning performance and safety, follow your owner's manual instructions.

**Register your warranty online at
www.Riccar.com**

Notes

RICCAR®
www.Riccar.com

Free Manuals Download Website

<http://myh66.com>

<http://usermanuals.us>

<http://www.somanuals.com>

<http://www.4manuals.cc>

<http://www.manual-lib.com>

<http://www.404manual.com>

<http://www.luxmanual.com>

<http://aubethermostatmanual.com>

Golf course search by state

<http://golfingnear.com>

Email search by domain

<http://emailbydomain.com>

Auto manuals search

<http://auto.somanuals.com>

TV manuals search

<http://tv.somanuals.com>