

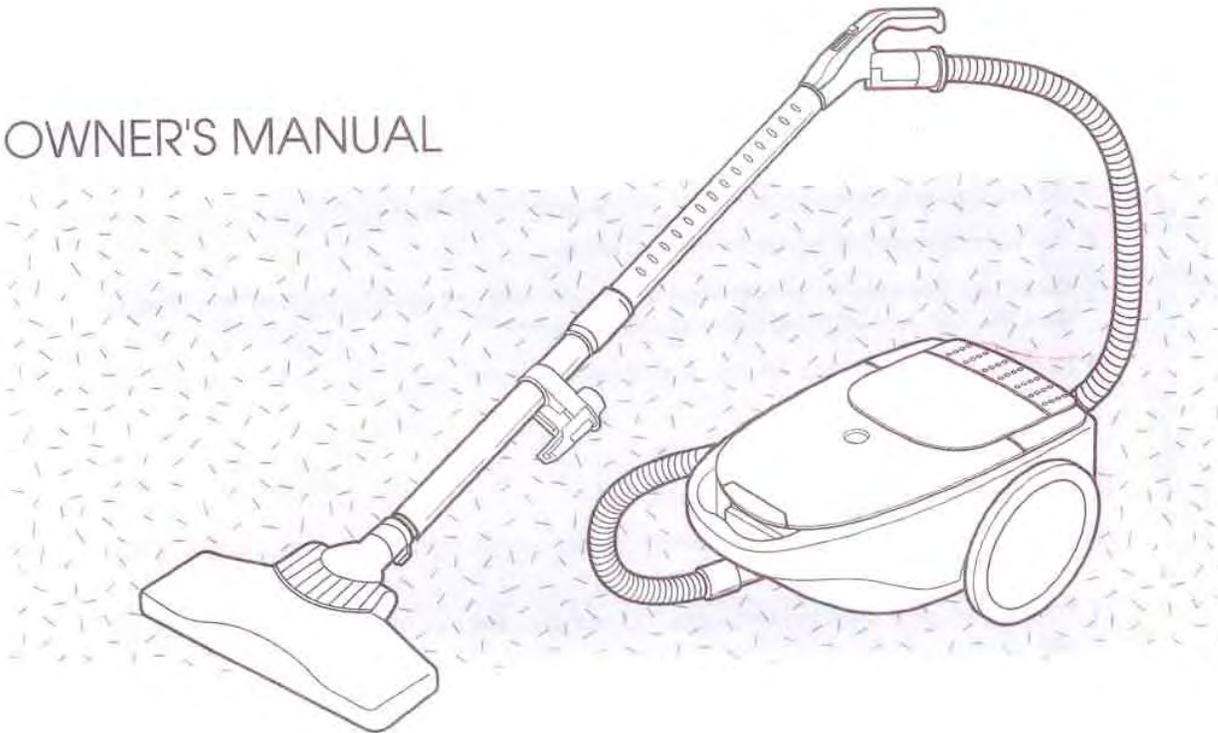

VACUUM CLEANER

RC 1400

OWNER'S MANUAL



READ AND KEEP THIS

- Thank you for purchasing this vacuum cleaner.
- For proper operation, please read this manual before using.

IMPORTANT SAFEGUARDS

Read All Instructions Carefully Before Using

When using an electrical appliance, basic precautions should always be followed including the following.

WARNING - To reduce the risk of fire, electric shock, or injury

1. Do not leave appliance when plugged in, Unplug from outlet when not in use and before servicing.
2. Do not use outdoors or on wet surfaces.
3. Do not allow to be used as a toy. Close attention is necessary when used by or near children.
4. Use only as description in this manual.
Use only manufacturer's recommended attachments.
5. Do not use with damaged cord or plug. If appliance is not working as it should, has been dropped, damaged, left outdoors, or dropped into water, return it to a service center.
6. Do not pull or carry by cord, use cord as a handle, close a door on cord, or pull cord around sharp edges or corners. Do not run appliance over cord. Keep cord away from heated surfaces.
7. Do not unplug by pulling on cord. To unplug, grasp the plug, not the cord.
8. Do not handle plug or appliance with wet hands.
9. Do not put any object into openings. Do not use with any opening blocked: keep free of dust, lint, hair, and anything that may reduce air flow.
10. Keep hair, loose clothing, fingers, and all parts of body away from openings and moving parts.
11. Turn off all controls before unplugging.
12. Use extra care when cleaning on stairs.
13. Do not use to pick up flammable or combustible liquids such as gasoline or use in areas where they may be present.
14. This appliance is intended for household use only and not for commercial or industrial use.
15. Do not operate the cleaner if:
 - the Power cord is damaged.
 - the hose shows visible signs of damage.It must be replaced by the manufacturer or its service agent or a similarly qualified person in order to avoid a hazard.

SAVE THESE INSTRUCTIONS

CONTENTS

DESCRIPTION AND USING	4~5
PRECAUTIONS FOR SAFE USE.....	6
BLOWER CLEANING	7
BEFORE ASKING FOR SERVICE	8

DESCRIPTION AND USING

DUST METER

How to check the DUST METER!

Operate the cleaner with MAX power keep the wide suction brush apart from the floor.

- If the red indicator of the DUST METER appears,
 - Empty the dust bag.
 - In case the hose is blocked with a large object, remove it.
- When cleaning with the crevice tool or the dusting brush, the red indicator may appear. In this case, continue cleaning.

CORD REW



HOSE HANDLE

POWER CONTROL

POWER CONTROL

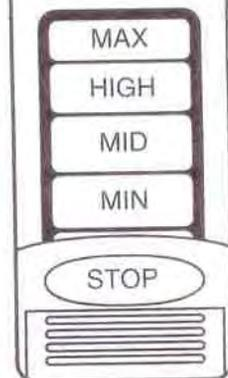

•TELESCOPIC PIPE

•PIPE HOLDER

•HOSE

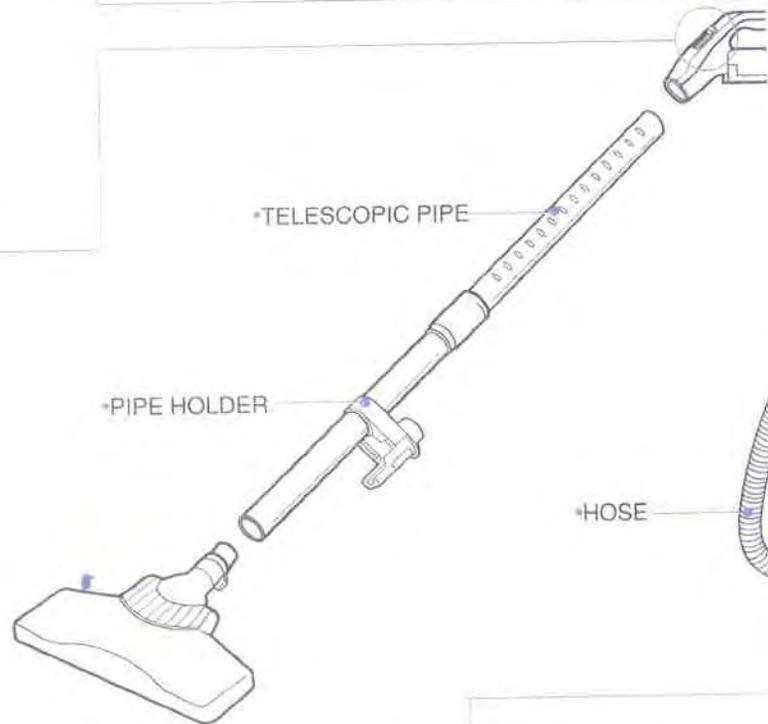

HOSE ADAPTER

- When separating the hose from the body, pull the hose adapter while pressing the button.

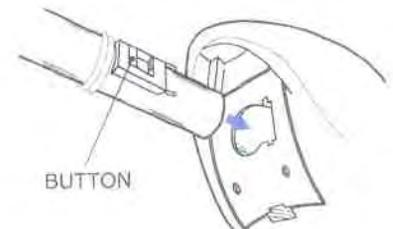

IND BUTTON

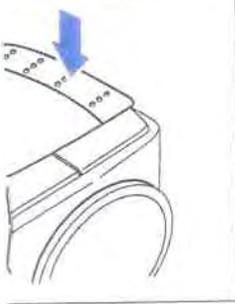

POWER CORD

- Connect to the same voltage as shown on the rating label.
- To plug or unplug, grasp the plug body. Do not hold or pull by the cord.

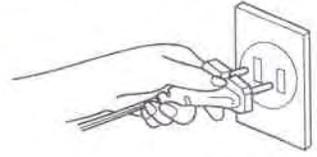

KEEPING

- Insert the pipe holder into the groove.

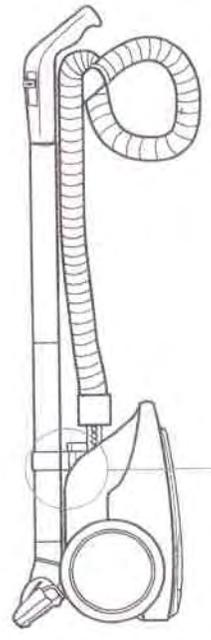
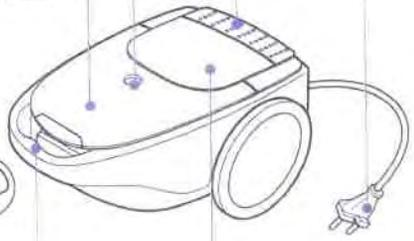
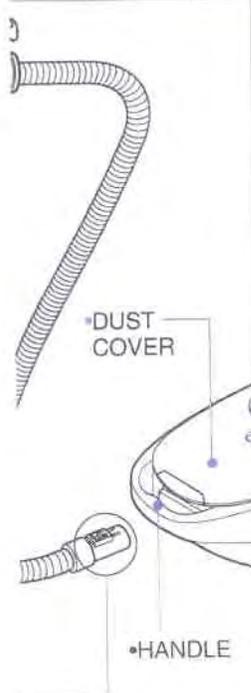
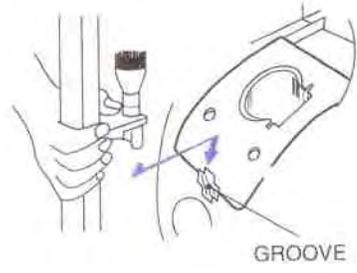

CLEANING TOOLS

- DUSTING BRUSH
- CREVICE TOOL

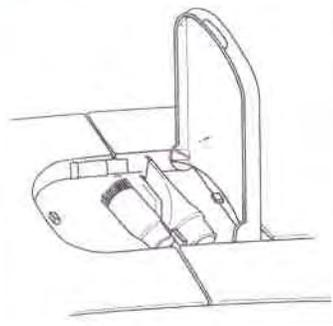
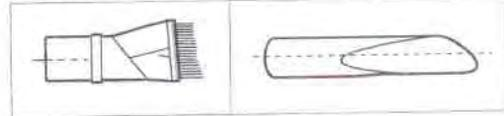

DESCRIPTION AND USING

DUST METER

- How to check the DUST METER!
Operate the cleaner with MAX power keep the wide suction brush apart from the floor.
- If the red indicator of the DUST METER appears,
 - Empty the dust bag.
 - In case the hose is blocked with a large object, remove it
 - When cleaning with the crevice tool or the dusting brush, the red indicator may appear. In this case, continue cleaning.

CORD REWIND BUTTON

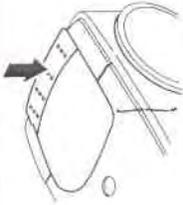

POWER CORD

- Connect to the same voltage as shown on the rating label.
- To plug or unplug, grasp the plug body. Do not hold or pull by the cord.

KEEPING

- Insert the pipe holder into the groove.

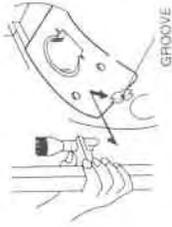

HOSE HANDLE

POWER CONTROL

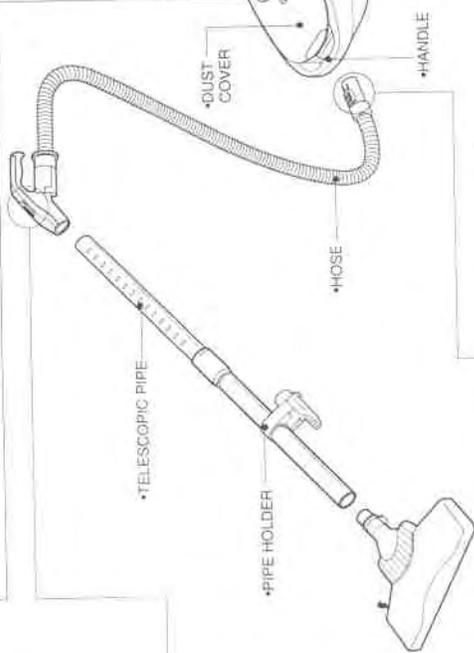
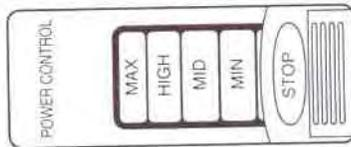

HOSE ADAPTER

- When separating the hose from the body, pull the hose adapter while pressing the button.



CLEANING TOOLS

- DUSTING BRUSH
- CREVICE TOOL

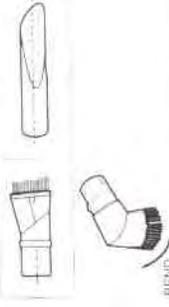

BEND

5

4

Reduced Image of Center page 4 and 5

PRECAUTIONS FOR SAFE USE

This vacuum cleaner should only be used for normal dry household dust and dirt. The manufacturer cannot be held responsible for any damage caused by use or operation of the cleaner contrary to these instructions. If the cleaner is wrongly operated for a purpose other than that for which it is intended, no liability can be accepted for any possible damage.

- Do not vacuum areas which contain moisture or water and inflammable matter, needles, pins, razor blades, matches, cigarette-ends, etc., since they may damage the cleaner or dust bag.



- When rewinding the power cord, hold the plug body before pressing the cord rewind button to prevent whipping.
- Do not pull the power cord out beyond the specified length.



- Make sure a dust bag and a motor protection filter are always inserted.



- This product is equipped with a polarized alternating current line plug (a plug having one blade wider than the other). This plug will fit into the power outlet only one way. This is a safety feature. If you are unable to insert the plug fully into the outlet, try reversing the plug. If the plug should still fail to fit, contact an electrician to replace the obsolete outlet. Do not defeat the safety purpose of the polarized plug.

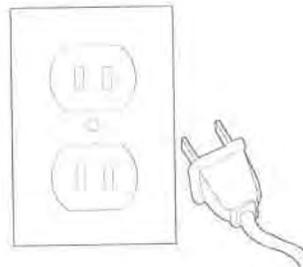

BLOWER CLEANING

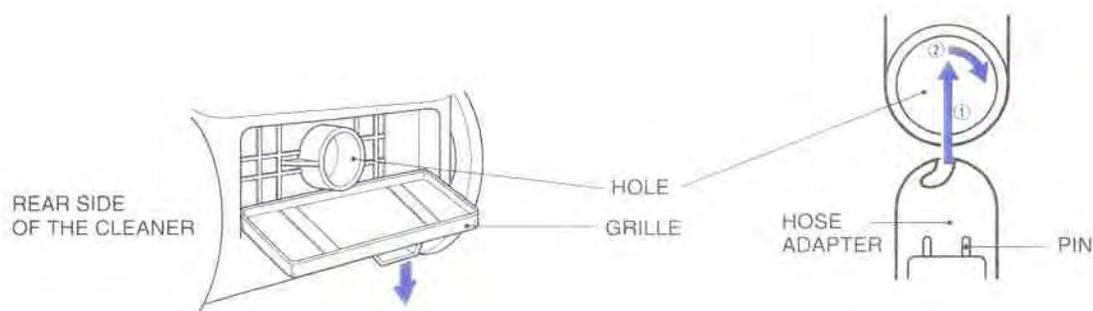

- Open the grille.
- Separate the hose adapter from the front side of the cleaner, then insert it into the hole and rotate it clockwise. (As inserting the hose adapter into the hole; the blower cleaning is started.)
- In order to get strong blowing, attach the crevice tool to hose handle.
- When separating the hose adapter from the hole, rotate it counterclockwise and pull it out.
- No danger in touching the pins under blower cleaning.
- When the dust bag is getting full with dust, the blowing is getting weaker. In this case, operate with the dust cover open.

EMPTYING THE DUST BAG

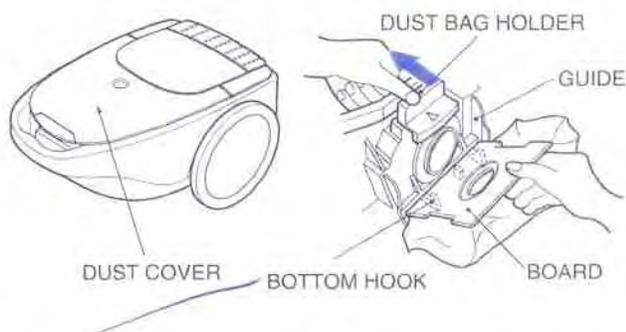

- Open the dust cover and push the dust bag holder in the direction of the arrow mark, and then take out the dust bag.
- When inserting the dust bag, place the board of the dust bag between the two guides and insert the lower part of it into the bottom hooks and fix the upper part of it with the dust bag holder.
- The dust cover can not be closed completely when the dust bag is set wrong.

REPLACING THE FILTER

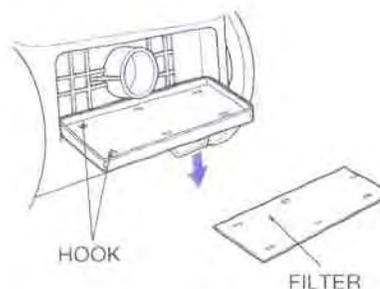

- Open the grille
- Take the filter and replace it.

BEFORE ASKING FOR SERVICE

Please check each item below if you have trouble with your cleaner.
Before checking, ensure that the cleaner is unplugged from the power supply.

PROBLEM	CHECK POINT	MEASURE
<ul style="list-style-type: none"> Suction power is weak. 	<ul style="list-style-type: none"> Dust bag Hose 	<ul style="list-style-type: none"> If it is full with dust, empty it. If clogged or blocked, remove the object.
<ul style="list-style-type: none"> The cleaner does not work. 	<ul style="list-style-type: none"> Is the hose adapter inserted into the suction opening of the cleaner completely? When the dust bag is full or blocked or any of the accessories are blocked, the over-heating protection for the motor is activated. 	<ul style="list-style-type: none"> Insert it completely. Switch off and unplug the cleaner and check the dust bag and accessories and remove any blockages. The cleaner can be switched on again after about 20 minutes.
<ul style="list-style-type: none"> Power cord does not rewind. 	<ul style="list-style-type: none"> Power cord 	<ul style="list-style-type: none"> Pull the power cord out a little and press the cord rewind button.
<ul style="list-style-type: none"> Power cord won't pull out of the cleaner. 	<ul style="list-style-type: none"> Power cord 	<ul style="list-style-type: none"> Do not pull it by force. Rewind it a little by pressing the cord rewind button and pull it out.

Free Manuals Download Website

<http://myh66.com>

<http://usermanuals.us>

<http://www.somanuals.com>

<http://www.4manuals.cc>

<http://www.manual-lib.com>

<http://www.404manual.com>

<http://www.luxmanual.com>

<http://aubethermostatmanual.com>

Golf course search by state

<http://golfingnear.com>

Email search by domain

<http://emailbydomain.com>

Auto manuals search

<http://auto.somanuals.com>

TV manuals search

<http://tv.somanuals.com>