



# VRA2.0i 2 Channel Stereo Amplifier

Dear Customer, CONGRATULATIONS. The VRA2.0i 2 Channel Stereo Amplifier, when used as described, will give you years of dependable service in your car, truck, RV or mini-van. We have taken numerous measures in quality control to ensure that your product arrives in top condition, and will perform to your satisfaction. In the rare event that your VRA2.0i 2 Channel Stereo Amplifier contains a damaged or missing item, does not perform as specified, requires warranty service or you have an installation problem. **DO NOT RETURN THIS PRODUCT TO THE STORE.** Please call our TOLL FREE number US (800-445-1797) and ask to speak with a member of our technical service team, or submit your questions by E-Mail to customerservice@vr-3.com and a member of our technical service team will respond by E-Mail to your questions. Our in-house technical service team will expedite delivery of your part, advise you on installation, or help troubleshoot a problem with you. If your product needs warranty service, our technical service team representative will help you obtain the fastest remedy possible under the warranty.

## Specifications

- 200 Watts Total Peak Power
- 2 X 100 Watts Peak into 4 Ohm @ 1Khz (+/- 5%)
- 50 Watts per channel @ 4 Ohms < or = 1% THD+N. S/N > or = 75 dbA ref. 1 Watt Output @ 14.4 VDC.
- Measured at 14.4 VDC Input Voltage
- Frequency Response: 20 Hz to 25,000 Hz +/- 3 db
- THD: Less than 1% Both Channels
- Dimensions: 2" H X 10.25" W X 9.25" D (5.08cm H x 26.04cm W x 23.5cm D)
- Input Sensitivity: 250 mV to 6 Volts
- Signal to Noise Ratio: Greater than 75 db
- Bass Boost: 0 or +6 db
- Adjustable Crossover Freq.: 50 Hz to 250 Hz
- Output Impedance: 4 Ohm Recommended
- Bridgeable: 4 Ohm Impedance Minimum
- Fuse: 20 Amp Automotive Blade Type

## Parts



• 1 Ground Wire

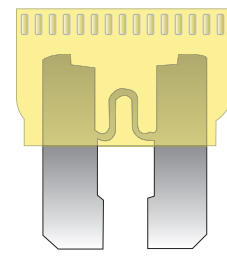

• 20 Amp Fuse



• 4 Hook & Loop Fasteners

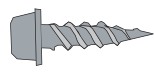

• 1 Self Tapping Screw



• Spade Terminal

## Features & Functions

### Frente la Unidad

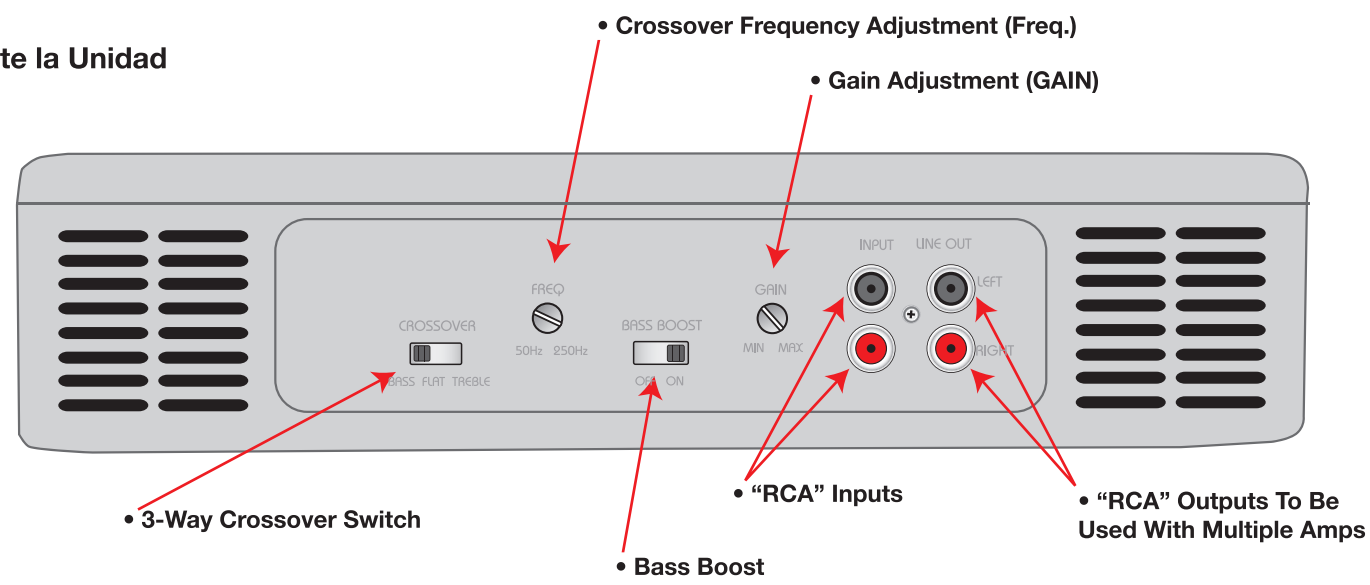

### Rear of Unit

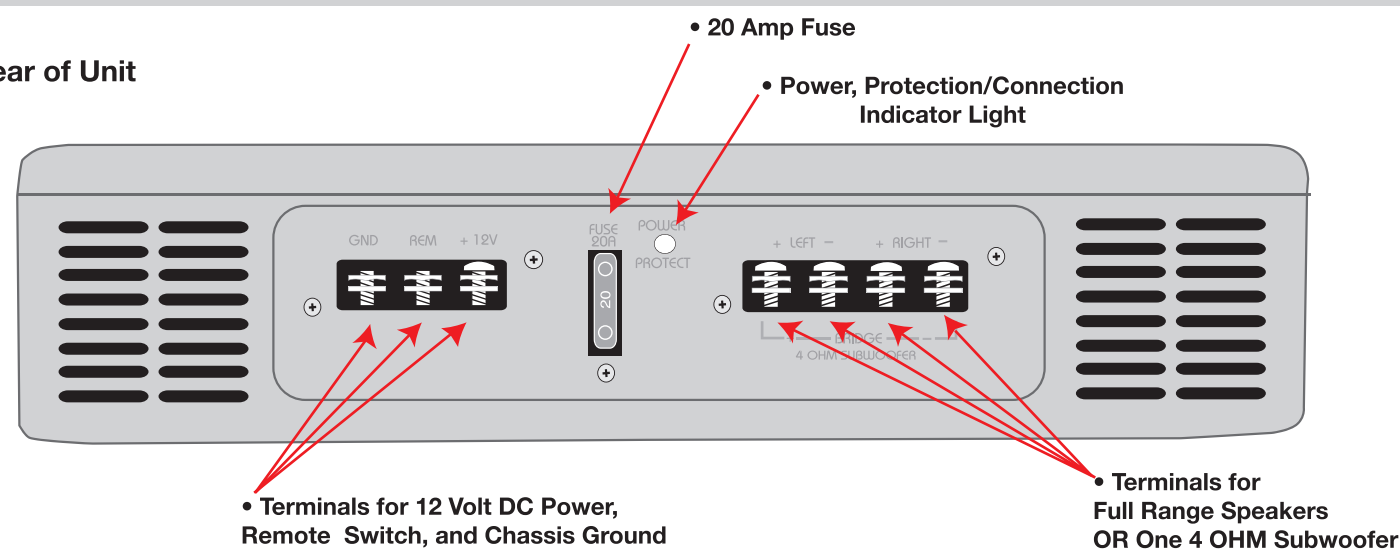

**WARNING** FOR USE WITH ONE 4 OHM SUBWOOFER ONLY!

## 1 Pre-installation

### Tools Needed For Installation:

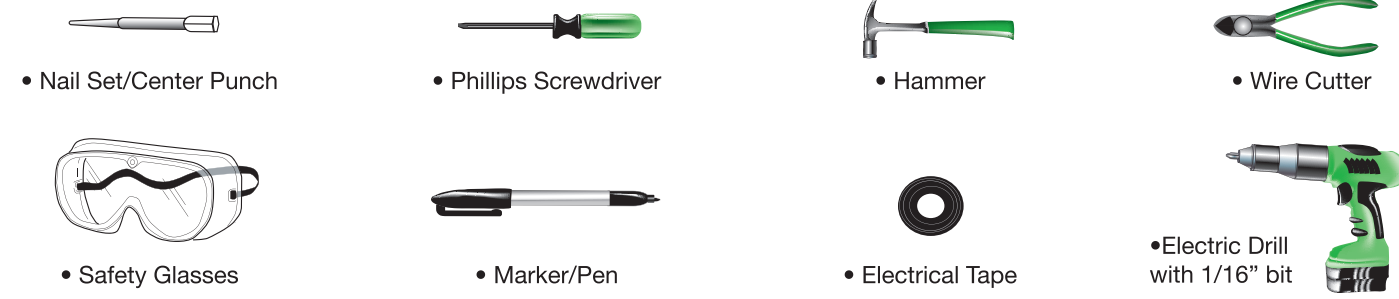

### We recommend an Amplifier Installation Kit containing the following parts:

- Power Wire - 8 Gauge w/ Terminal Lug
- Speaker Wire - 16 to 12 Gauge
- RCA "Y" Adaptors
- Remote Wire - 20 Gauge
- Input Wires - Shielded RCA cables
- After-Market Battery Terminal

### Location

When choosing a location for the amplifier keep in mind that the amplifier will generate heat. Place the amplifier in a location that allows air to circulate around it. Amplifier location and installation will vary from vehicle to vehicle depending on physical layout of the vehicle. Carefully consider as many installation locations and configurations as is practically possible. DO NOT COVER the amp with carpet or enclose it behind interior panels. DO NOT mount inverted or upside down. The amplifier may be mounted vertically.

Before permanently installing your VRA2.0i Amplifier, place the VRA2.0i Amplifier in the approximate place it will occupy in your car. Run all power and speaker wires inside the vehicle toward the amplifier prior to mounting. This will allow you to estimate how much wire you'll need and where to route the wires inside of your vehicle.

Connect the fused 12 Volt DC power wire, chassis ground cable, and remote wires. (SEE SECTION 3, ELECTRICAL CONNECTIONS)

Turn on the amplifier, if the Power Protection light is green, turn off the amplifier and proceed to the next section. If the Power Protection light is red, review all of the connections and wires. You may have a loose connection, a bad chassis ground, or an inadequate size power wire. If the problem persists after reviewing all of the connections and wires, call our toll-free help line for assistance.

**WARNING** Allow for air to circulate around the amplifier. Do not mount inverted or upside down. Do not cover with carpeting or enclose it behind interior panels. Avoid mounting under a seat.

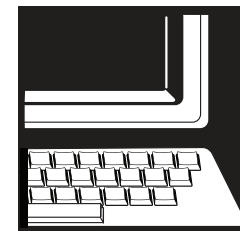

GIVE US A CALL, WE'LL HELP YOU INSTALL.

PLEASE DO NOT RETURN PRODUCT TO STORE. Visit us on the WEB

[www.vr-3.com](http://www.vr-3.com)

For Information and Technical Assistance, Call Toll-Free in U.S.A. and Canada.

1-800-445-1797

## 2 Mounting the Amplifier

**WARNING** Water Damage: Do not install this amplifier in a location that will expose it to water or moisture. Dust or Dirt: Do not install this amplifier in a location that will expose it to dusty or dirty conditions. Modifications: Do not open the amplifier for any reason, or modify the amplifier in any way. If modified in any way a fire hazard or malfunction may occur. Modification will void the warranty.

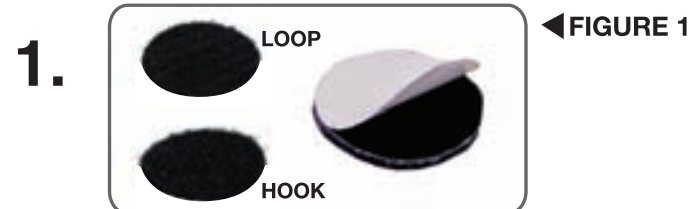

1. With the two pieces of the round hook & loop fastener attached to each other, peel the backing paper from "loop" side of the round shaped hook & loop fastener. (Figure 1)



2. Next, align the hook & loop fastener with the bottom of the amplifier and press firmly to adhere. (Figure 2)



3. With the "hook" half of the hook & loop fastener attached to the "loop" half you just attached to the amplifier, peel off back paper. NOTE: If you plan to attach the amplifier to carpeting, simply take off the "loop" half and discard. (Figure 3)



4. Then press the amplifier firmly onto the desired area. Adhesive reaches maximum strength in 24 hours. Moving fastener from its original position will weaken the adhesive and may damage the mounting surface. (Figure 4)

**NOTE** When mounting the amplifier, make sure there is enough room for access to make adjustments to the switches and adjustment screws.

## 3 Electrical Connections

**WARNING** Read the following wiring instructions very carefully. If you have any trouble understanding any of these instructions, have the amplifier professionally installed by an experienced technician. Incorrect wiring will prevent the amplifier from operating, or will damage the amplifier.

### Recommended Method For Splicing Wires

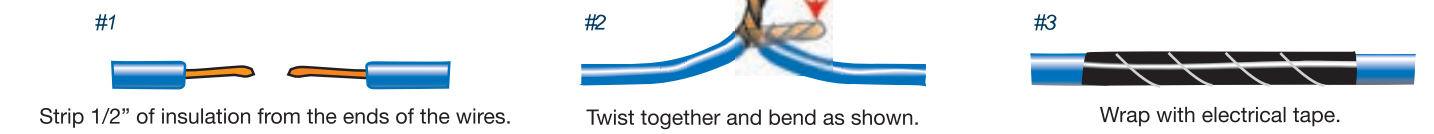

### 1. Power Terminal

1. DISCONNECT THE NEGATIVE(-) BATTERY TERMINAL FROM THE NEGATIVE BATTERY POST.
2. Strip 1/2" of insulation from the end of the 8 gauge power wire. Connect the 8 gauge power wire to the after-market positive battery terminal according to the manufacturer's installation instructions.

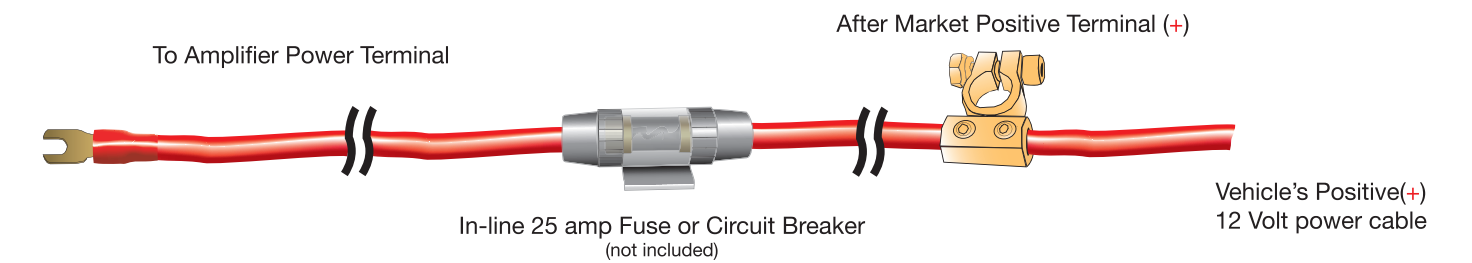

3. Install a 20 amp fuse or 20 amp circuit breaker in the 8 gauge power wire as close to the battery as practical.
4. Route the 8 gauge power wire from the 20 amp fuse or circuit breaker to the rear of the amplifier.
5. Strip 1/2" width of insulation from the end of the 8 gauge power wire.
6. Attach a spade lug on the end of the 8 Gauge wire.
7. Loosen screw to open POWER connector plates on rear of amplifier.
8. Insert the spade lug between the connector plates. Turn screw until power cable is tight.

### 2. Remote Terminal

The REMOTE wire connection automatically turns on your amplifier when your stereo is turned on. On most stereos, this wire is marked as the REMOTE, ACCESSORY, or POWER ANTENNA.

1. Locate the REMOTE, ACCESSORY, or POWER ANTENNA on the stereo. (Refer to your stereo owner's manual.)
2. Splice the REMOTE, ACCESSORY or POWER ANTENNA wire from rear of the stereo to a length of wire that will reach the rear of the amplifier
3. Loosen screw and open REMOTE connector plates on rear of amplifier.
4. Insert wire end between the REMOTE connector plates.
5. Tighten screw closing REMOTE connector plates on wire.

### 3. Ground Terminal

1. The ground connection cable should be attached to clean, unpainted chassis metal for a good electrical connection.
2. Find good, non-rusted chassis metal, as close to the amplifier as possible.

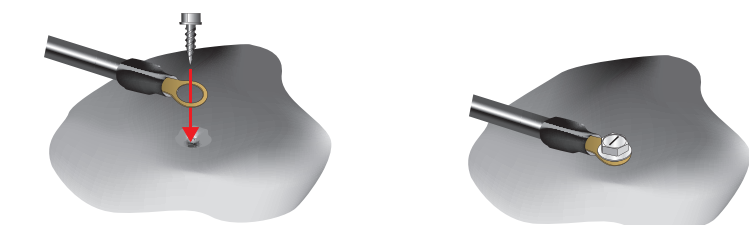

3. Drill a pilot hole with a 1/16" drill bit.
4. Use sandpaper to expose an area of bare metal around the pilot hole about the size of a dime.
5. Tightly fasten the provided ground cable with the self tapping sheet metal screw to the chassis metal. A loose ground will cause distortion and popping noises in the speakers.

### Recommended Method For Attaching Wires to Terminals

#### 1. GROUND WIRE

To connect the supplied ground wire, remove the screw and contact from the ground terminal on the rear of the amplifier. Put the screw through the contact plate, then through the ground wire, and finally tighten the screw.

#### 2. REMOTE WIRE

To connect the remote wire, place the twisted end under the contact plate and tighten screw.

#### 3. POWER WIRE

When connecting the power wire, place the spade terminal under the contact plate and the forks around the screw. Then tighten the screw.

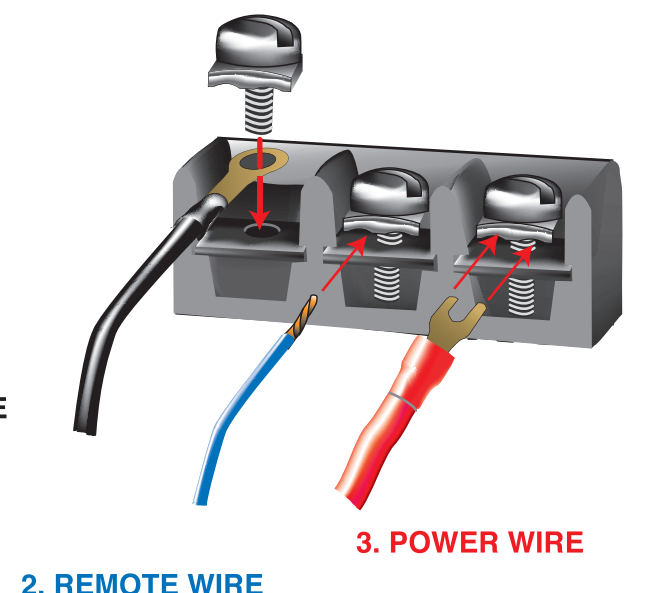



## 4 RCA Line Inputs

The line inputs on the front of the amplifier receive low level, high impedance signals from the low level RCA outputs of the car stereo. The amplifier receives the signals and converts them to high level, low impedance signals to be used to drive the speakers. All of the amplifiers line inputs need to be connected to the car stereo, in order to use all of the speaker outputs.

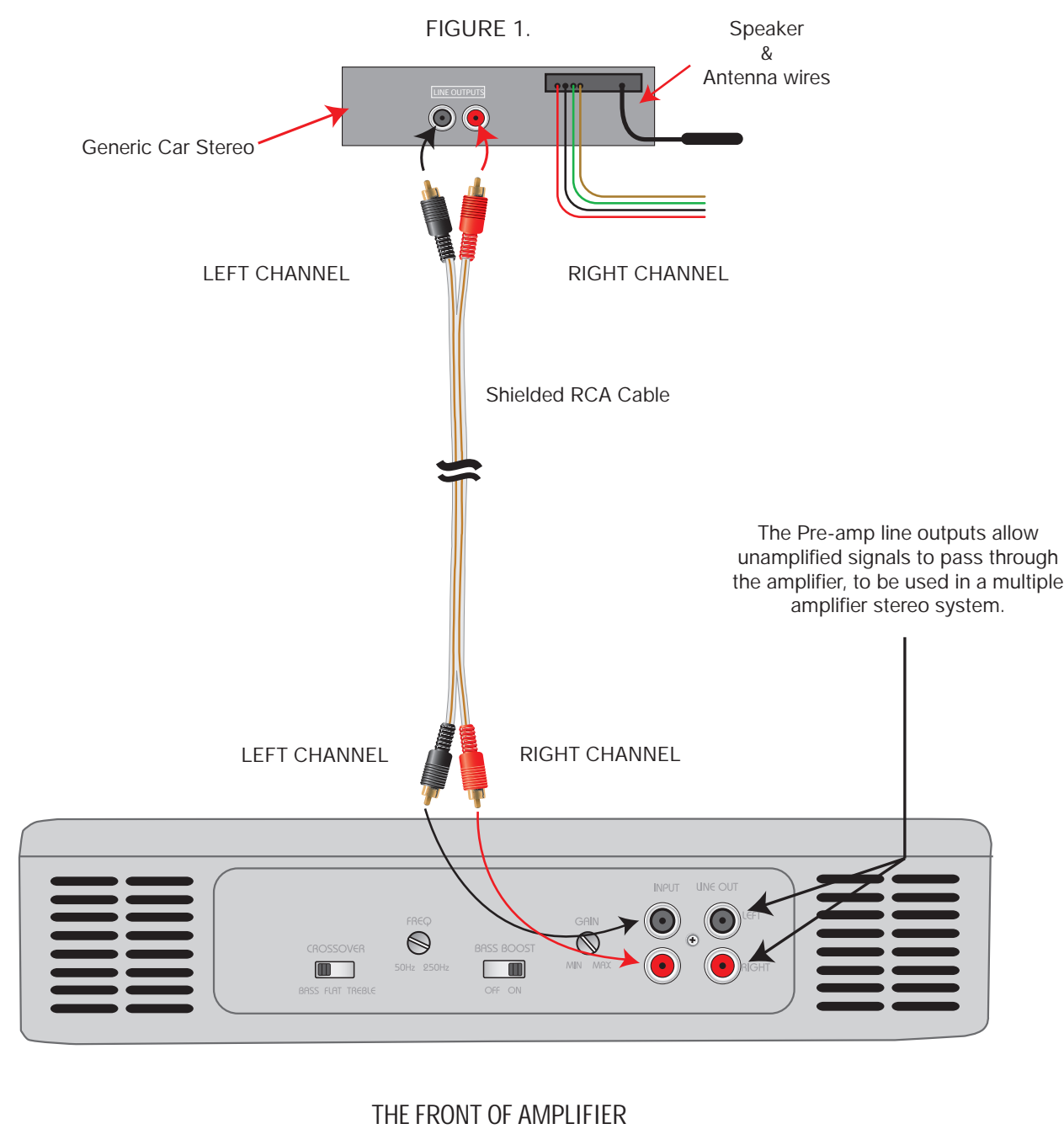

### Adaptors & Cables

If your stereo does not have RCA type output jacks, a high level to low level adaptor will need to be purchased. The high level to low level adaptor takes the signals from the car stereo's speaker wires and converts them to low level, high impedance signals to be used by the amplifier. Install the converter according to the manufacturers' instructions.

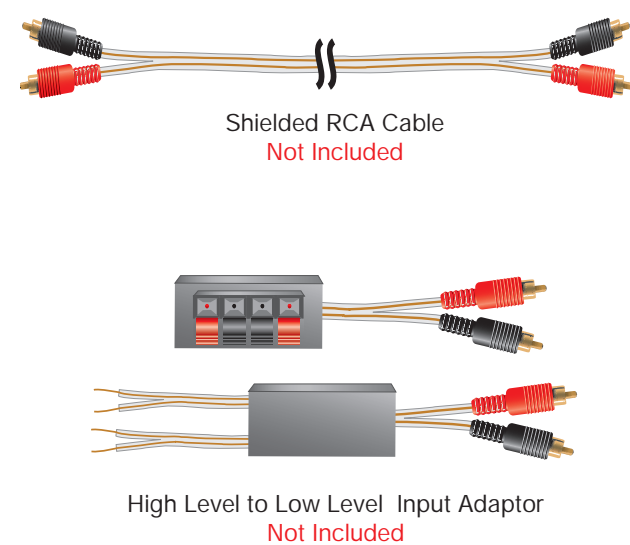

**Do not splice RCA jacks directly to the car stereo's speaker wires.**



**You must trim the unused speaker wires on the stereo and wrap with electrical tape as shown to prevent a short circuit.**



**The colors of the jacks on the RCA cables and adaptors shown here are for illustration purposes. The color of the cables and adaptors that you purchase for installation will vary by manufacturer.**

## 5 Amplifier Settings

### Gain Control



The GAIN control matches the line output of your car stereo's RCA jacks to the line inputs of the amplifier. When you have completed installing the amplifier, turn the gain control to about 1/2 way (recommended). If you have any distortion at this setting, play a CD or cassette on the car stereo, set the bass and treble at 50%, and set the equalizer, if you have one, to flat across all frequencies. Also make sure the left & right balance and front & rear fader settings are set in the middle. Never turn the Gain fully clockwise. This will cause a malfunction.

### Frequency Adjustment Screw



The frequency adjustment screw (FREQ.) only has an effect if the crossover switch is set to "BASS" or "TREBLE", it has no effect when the crossover is set to FLAT.

To set the FREQ. when the crossover is set to BASS, turn FREQ. all the way to the right, this allows a range of sound from 50 Hz - 250 Hz to the sub woofer(s). As you turn the FREQ. to the left (counter clockwise), you will be cutting off the high frequencies coming from the sub woofer(s).

To set the FREQ. when the crossover is set to TREBLE, turn FREQ. all the way to the left (counter clockwise) this will allow the full range of sound to the front speakers. As you turn the FREQ. to the right (clockwise), you will be cutting off the low frequencies coming from the front speakers.

### Bass Boost



The BASS BOOST switch adds a additional 6dB at 50Hz. It normally is set to off. Turning on BASS BOOST, will not make the bass sound better, it only adds volume to the lowest frequency.

## 6 Speaker Wiring & Options

### Two Full Range Speakers

To use two full range speakers with the amplifier, connect one speaker to the right channel and the other speaker to the left channel as shown. Set the crossover switch to FLAT.

The FLAT setting allows the full range of sound to the speakers. When the crossover switch is set to FLAT, the FREQ. adjustment screw has no effect.

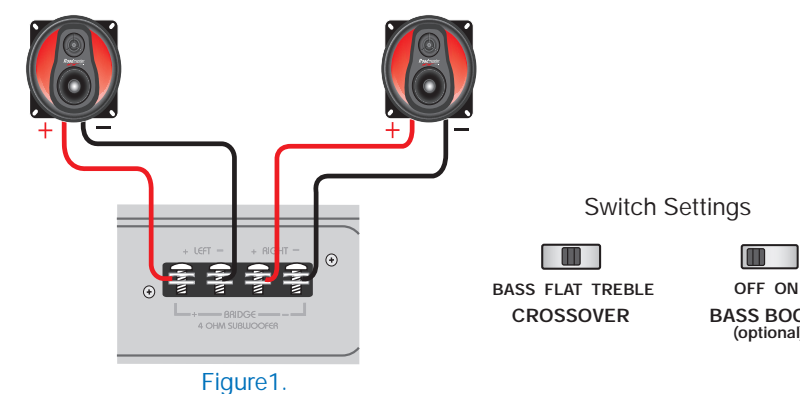

### Two Single Voice Coil Subwoofers

Connect two single voice coil subwoofers to the amplifier, connect one subwoofer to the right channel and the other subwoofer to the left channel as shown in FIGURE 1. Set the crossover switch to BASS.

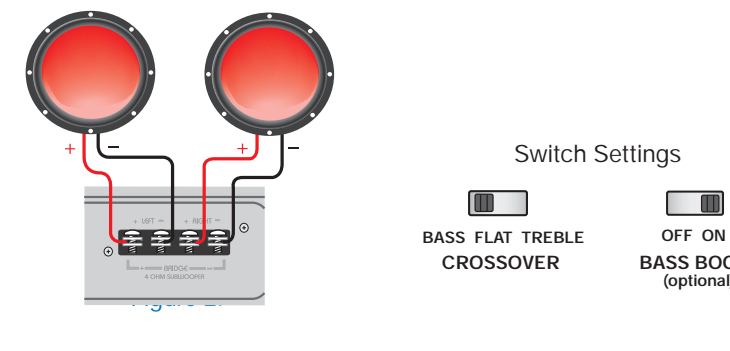

### One Dual Voice Coil Subwoofer

To use one dual voice coil subwoofer with the amplifier, connect one voice coil to the right channel and one voice coil to the left channel as shown in FIGURE 2. Set the crossover switch to BASS.

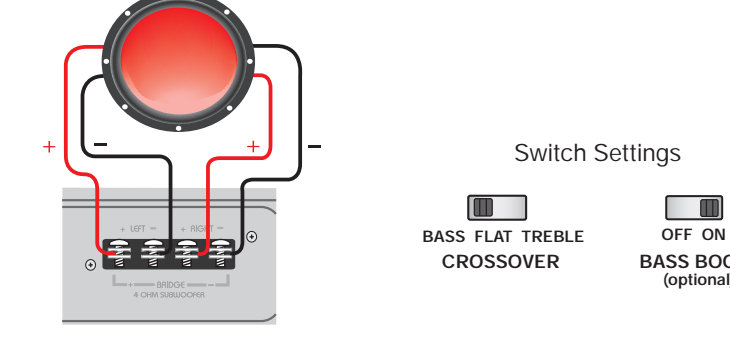

### One Bridged Sub Woofer

Connect one subwoofer to the amplifier, by bridging the speaker terminals on amplifier, connect the subwoofer's positive(+) terminal to the positive(+) terminal of the amplifier's left channel, connect the negative(-) terminal of the subwoofer to the negative(-) terminal of the amplifier's right terminal. Set the crossover switch to BASS.

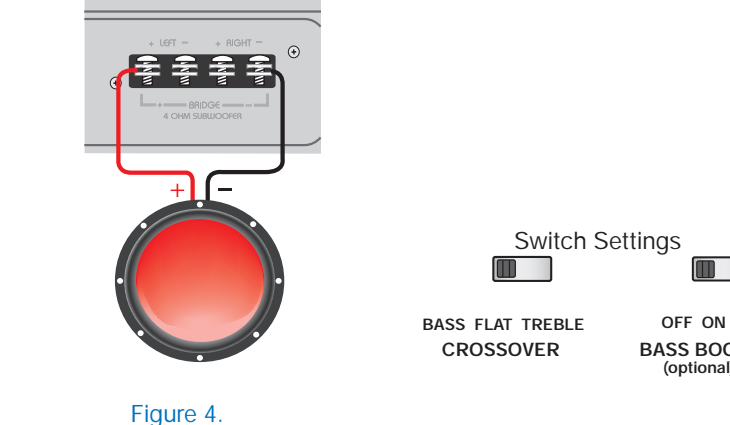

**Do not wire a second 4 ohm sub woofer in parallel, this may result in damage to the amplifier.**

## Frequently Asked Questions

### What is the per channel RMS power of this amplifier?

50 Watts RMS per channel times two channels. Consult the specifications in the installation manual.

### What is a 3 Way Electronic Crossover?

A 3 Way Electronic Crossover divides the audio signal into two parts, this permits you to customize the amplifier to power a subwoofer (BASS), or a pair of satellite tweeters like the RoadmasterUSA RT-15 (TREBLE). When the switch is set to (FLAT) the full audio signal will power a pair of full range speakers.

### Can I hook up two speakers to this amplifier?

The VRA2.0 is designed to operate two full range speakers, one on the left channel and one on the right channel. It can drive two single voice coil subwoofers, one on the left channel & and one on the right channel. It will also drive a dual voice coil sub woofer, with one coil connected to the right channel, and one voice coil connected to the left channel.

### Can I wire a bridged subwoofer ("Bridge" two channels)?

Yes you can connect a subwoofer by bridging the two channels, see Speaker Wiring and Options.

### What if my car radio doesn't have RCA line outputs?

You will need a converter used to change the signals from the speaker wires to RCA line level inputs. Follow the converter manufacturer's installation instructions.

### What should I do if my car radio doesn't have a remote wire?

Connect the amplifier remote terminal to a switched 12 volt circuit controlled by the ignition switch. This will turn the amplifier off when the ignition switch is turned off.

### Do I need a stiffening capacitor with this amplifier?

It never hurts to have extra reserve power when operating an amplifier of this caliber.

### Why does the Power / Protect LED switch between green & red?

Suspect the power and ground connections, insufficient wire size to carry the current demand, or an improper impedance load (especially if bridging two channels into one).

### Why does the Power / Protect LED stay red?

This typically indicates that one or more of the MOSFET output transistors has shorted.

**This condition will not fix itself. The amplifier must be returned to Virtual Reality Sound Labs for repair.**



**GIVE US A CALL, WE'LL HELP YOU INSTALL.**

**PLEASE DO NOT RETURN PRODUCT TO STORE.**  
Visit us on the WEB

**www.vr-3.com**

For Information and Technical Assistance,  
Call Toll-Free in U.S.A. and Canada.

**1-800-445-1797**

## Limited Warranty

VIRTUAL REALITY VIDEO LABS® products are designed and manufactured to provide a high level of trouble-free performance. VIRTUAL REALITY VIDEO LABS warrants, to the original purchaser, that its products are free from defects in material and workmanship for 30 days from the date of original purchase. As part of our commitment to product excellence, VIRTUAL REALITY VIDEO LABS and/or its affiliates routinely improve the designs, materials or production methods of its existing products. Because it is impractical to publicize all changes in every product, we reserve the right to make such changes without notice.

### CONDITIONS OF WARRANTY:

If during the 30 day warranty period your new product is found to be defective, VIRTUAL REALITY VIDEO LABS will repair such defect, or replace the product, without charge for parts or labor subject to the following conditions:

1. All repairs must be performed by VIRTUAL REALITY VIDEO LABS and/or its affiliates in Eatontown, New Jersey.
2. The equipment must not have been altered or been damaged through negligence, accident, or improper operation.
3. The replacement of parts are exempted from this warranty when replacement is necessary due to normal wear and tear.
4. All warranty claims must be accompanied by a copy of the sales receipt or bill of sale.
5. Repair or replacement parts supplied by VIRTUAL REALITY VIDEO LABS under this warranty are protected only for the unexpired portion of the original warranty.
6. In the case of car stereos, this warranty does not extend to the elimination of car static or motor noise; correction of antenna problems; costs incurred for the removal or reinstallation of the product; damage to tapes, speakers, accessories or car electrical systems.
7. VIRTUAL REALITY VIDEO LABS will not be responsible for any charge incurred for installation.

### OWNER'S RESPONSIBILITIES:

VIRTUAL REALITY VIDEO LABS will make every effort to provide warranty service within a reasonable period of time.

**SHOULD YOU HAVE ANY QUESTIONS ABOUT SERVICE RECEIVED, OR IF YOU WOULD LIKE ASSISTANCE IN OBTAINING SERVICE, PLEASE CALL TOLL FREE 1-800-445-1797, 8:30am - 4:30pm EST.**

In order to provide you with the proper warranty service, we request that you adhere to the following procedure:

1. Include a copy of your sales receipt or bill of sale with your unit when it is returned for warranty service.
2. If it is necessary to return your product for service, please return it securely packed, preferably in the original shipping carton, and freight and insurance prepaid to the following address: VIRTUAL REALITY VIDEO LABS, Service Department, 41 James Way, Eatontown, New Jersey 07724.
3. Please include a detailed explanation of the problem you are having.
4. If your product is found by VIRTUAL REALITY VIDEO LABS to have a defect in material or workmanship, within the warranty period, it will be repaired or replaced at no charge and returned to you prepaid. Where permitted by law VIRTUAL REALITY VIDEO LABS liability shall be limited to that set forth in this warranty. This warranty shall be the exclusive remedy of the purchaser.

VIRTUAL REALITY VIDEO LABS makes no other warranty of any kind, expressed or implied; and all implied warranties, are hereby disclaimed by VIRTUAL REALITY VIDEO LABS and excluded from this warranty, VIRTUAL REALITY VIDEO LABS and/or its affiliates, the manufacturer, distributor and seller shall not be liable for any injury, loss or damage, incidental or consequential, arising out of the use or intended use of the product.

## Free Manuals Download Website

<http://myh66.com>

<http://usermanuals.us>

<http://www.somanuals.com>

<http://www.4manuals.cc>

<http://www.manual-lib.com>

<http://www.404manual.com>

<http://www.luxmanual.com>

<http://aubethermostatmanual.com>

Golf course search by state

<http://golfingnear.com>

Email search by domain

<http://emailbydomain.com>

Auto manuals search

<http://auto.somanuals.com>

TV manuals search

<http://tv.somanuals.com>