

ROBERTS

Enjoy Listening

DAB

Digital Audio Broadcasting

ZoomBox

**DAB / FM RDS digital radio and CD / SD player
with MP3 / WMA and LCD Zoom**



Please read this manual before use

Contents

<i>Controls</i>	2-4	<i>System reset</i>	26
<i>Aerial assembly</i>	4	<i>Headphone socket</i>	27
<i>Battery operation</i>	5	<i>Mains supply</i>	28
<i>Mains operation</i>	5	<i>General</i>	29
<i>Operating your radio - DAB</i>	6	<i>Specifications</i>	29
<i>Selecting a station - DAB</i>	7	<i>Guarantee</i>	30
<i>Secondary services - DAB</i>	7		
<i>Display modes - DAB</i>	8-9		
<i>Finding new stations - DAB</i>	9		
<i>Manual tuning - DAB</i>	10		
<i>Dynamic Range Control (DRC) settings - DAB only</i>	11		
<i>Operating your radio - Search tuning FM</i>	12		
<i>Manual tuning - FM</i>	13		
<i>Display modes - FM</i>	14		
<i>FM stereo / mono</i>	15		
<i>Presetting stations</i>	15-16		
<i>Compact discs / MP3/WMA CDs</i>	17-23		
<i>Using SD cards</i>	24		
<i>Software version</i>	25		
<i>Zoom display function</i>	25		
<i>Deep bass boost</i>	25		

Controls

(Front)

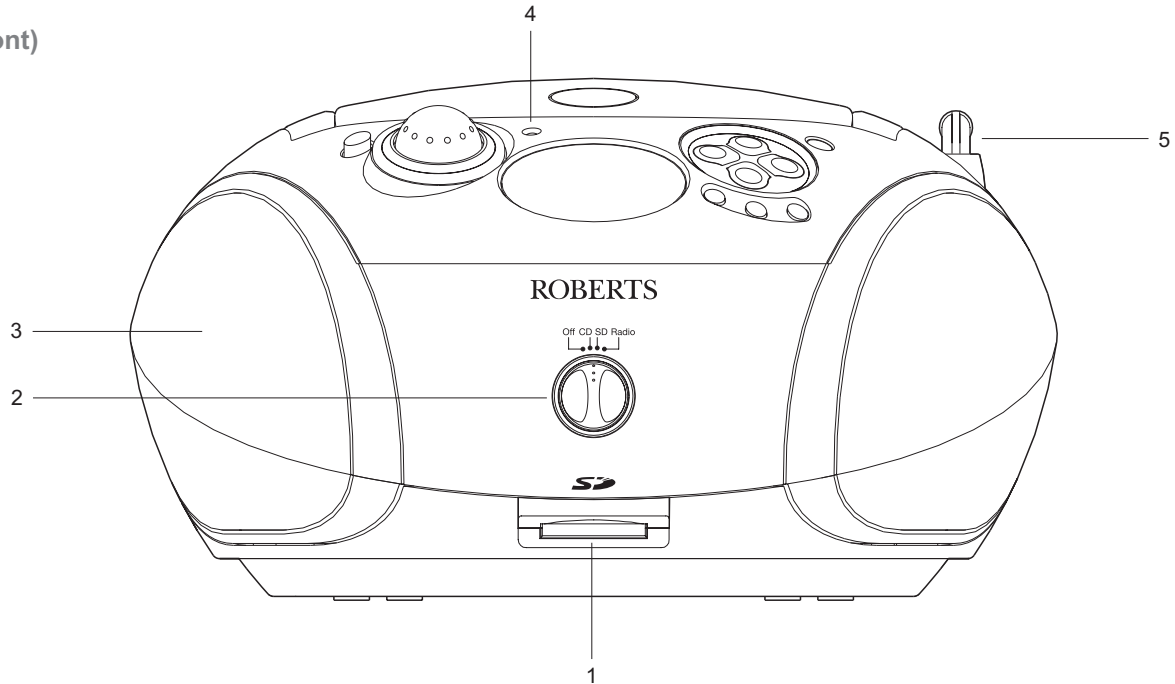

1. SD card slot

2. Function switch

3. Speaker x 2

4. On indicator light

5. Telescopic aerial stud

Controls

(Top)

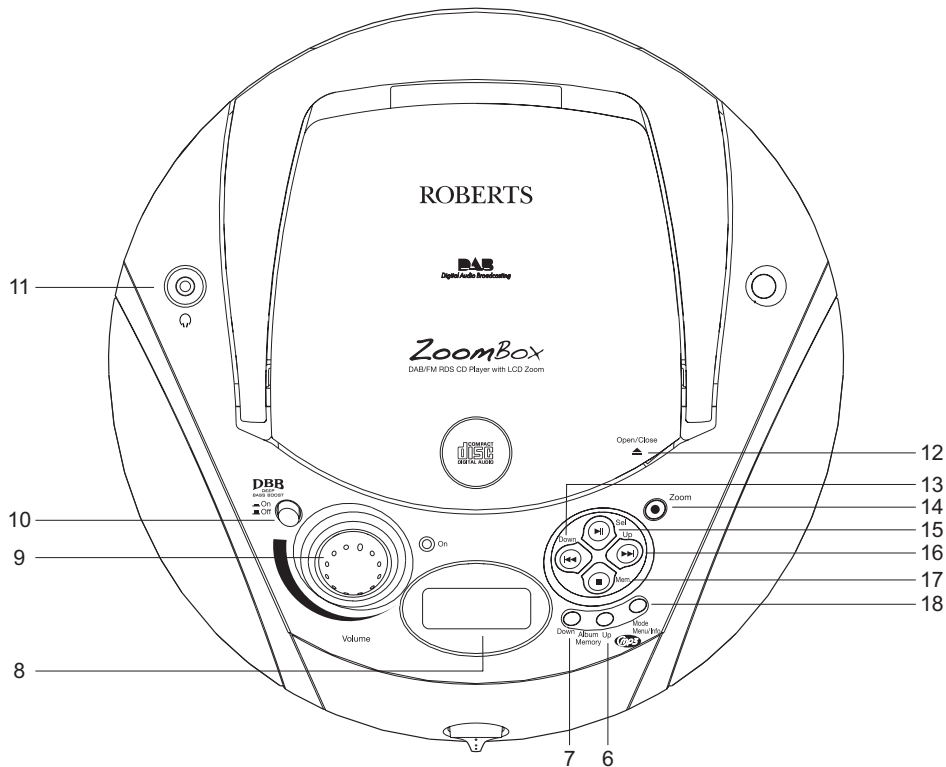

6. Album Up / Memory Up button

7. Album Down / Memory Down button

8. LCD display

9. Volume control

10. Deep bass boost button

11. Headphone socket

12. CD Open / Close

13. Tuning Down / Rewind button

14. Zoom button

15. Play / Pause / Select button

16. Tuning Up / Fastforward button

17. Stop / Memory button

18. Mode / Menu / Info button

Controls

(Left side)

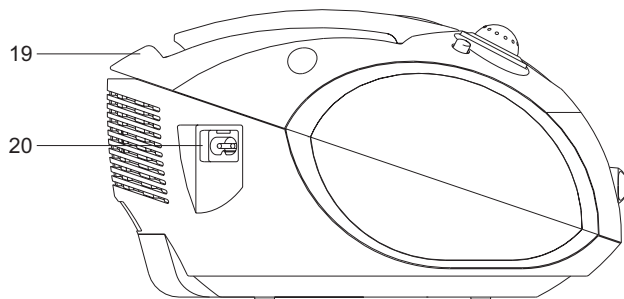

19. Handle

20. Mains power socket

(Right side)

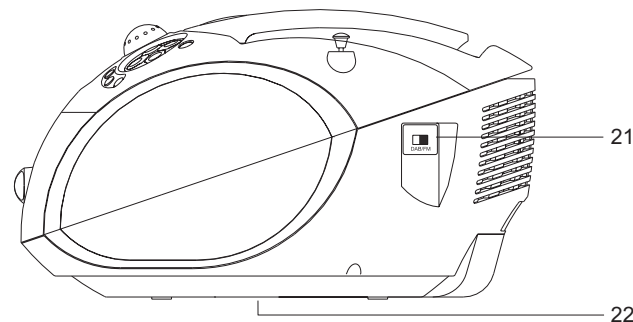

21. DAB / FM switch

22. Battery compartment

Aerial assembly

1. Before using your radio, screw the telescopic aerial on to the protruding aerial stud by rotating the body of the aerial in a clockwise direction (as viewed from above). Only rotate the aerial by hand. Do not use pliers or any other tools as this may damage the aerial.
2. When it is fully screwed in place, pull the body of the aerial upwards slightly to lift the aerial stud and reveal its hinge. Then lay the aerial flat and rotate it further to tighten it fully. The hinge will also allow the aerial to be positioned at an angle or collapsed and laid flat when not in use.
3. For best radio reception the aerial should be restored to a vertical orientation and fully extended.
4. The aerial may be removed for storage if necessary by collapsing the aerial and then rotating the aerial body in an anti-clockwise direction (as viewed from above).

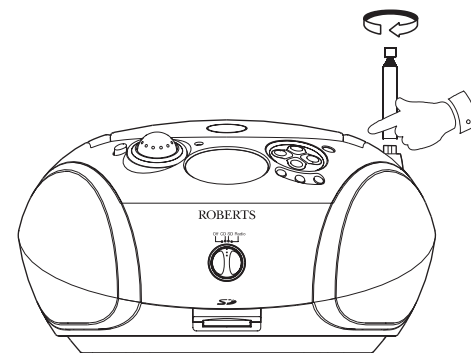

Battery operation

1. Slide the battery cover catch in the direction of the arrow. Open the battery cover.
2. Fit six LR14 (C size) batteries into the spaces in the compartment. Take care to ensure all batteries are inserted with the correct polarity as shown on the outside of the battery compartment. Replace the battery cover.
3. Reduced power, distortion and a 'stuttering' sound are all signs that the batteries may need replacing. If your DAB/FM CD player is not to be used for a prolonged period of time, remove the batteries to avoid damage by battery leakage.

We would recommend for economy that the ZoomBox is used on the mains whenever possible with battery operation for occasional or stand-by use only.

IMPORTANT: The batteries should not be exposed to excessive heat such as sunshine, fire or the like. After use, disposable batteries should if possible be taken to a suitable recycling centre. On no account should batteries be disposed of by incineration.

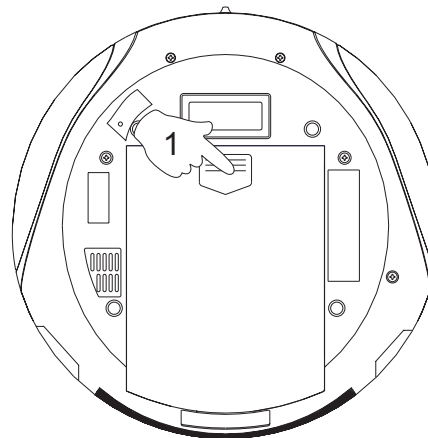

Mains operation

1. Place your CD player on a flat surface.
2. Plug the mains lead into the **Socket** located on the left hand side of your cd player ensuring that the plug is pushed fully into the socket.
3. Plug the other end of the mains lead into a wall socket and switch on the wall socket.

IMPORTANT: The mains plug is used as the means of connecting the radio to the mains supply. The mains socket used for the radio must remain accessible during normal use. In order to disconnect the radio from the mains, the mains plug should be removed from the mains socket outlet completely.

4. The On Indicator will light when the CD player is switched on.

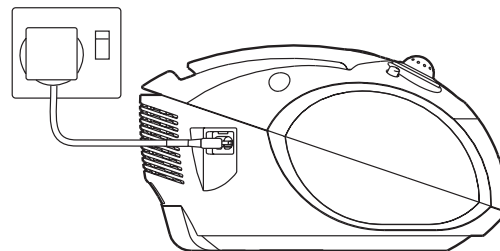

Operating your radio - DAB

1. Carefully extend the telescopic aerial (see page 4).
2. Slide the **DAB/FM switch** to the 'DAB' position. Switch on the unit by rotating the **Function switch** to the Radio position. The 'On' indicator will light.
3. The display will show 'Welcome' for a few seconds and the DAB symbol will appear in the display.
4. If this is the first time the radio is used a full scan of the UK band III DAB channels will be carried out. If the radio has been used before the last used station will be selected.
5. The autotune takes around 30 seconds. The display will continue to show 'Welcome'. The lower line will show the progress of the scan.
6. When the Autotune is complete the first station (in numeric-alpha order 0...9...A...Z) will be selected.
7. If the station list is still empty after the Autotune you radio will display "No Serv ready".
8. If no signals are found it may be necessary to relocate your ZoomBox to a position giving better reception.

Note: that radio station name and frequency displays shown in this user guide may differ from those that you see on your radio. Broadcasters may change radio station names that are transmitted, and the frequencies used for DAB and FM radio stations may not be the same in all parts of the country.



Selecting a station - DAB

1. When the unit is in DAB mode the upper line of the text display normally shows the name of the station currently tuned.
2. Repeatedly press the **Tuning Up** or **Down buttons** to scroll through the list of available stations on the lower line of the text display. Stop pressing the **Tuning buttons** when you find the station that you wish to hear.
3. Press and release the **Select button** to cause the radio to tune to the chosen station. The display may show "Tuning" while your radio finds the new station.
The use of memory presets is described on page 15.

4. Adjust the **Volume** to the required setting.

If after selecting a station the display shows "No Serv ready" it may be necessary to relocate your radio to a position giving better reception.

Secondary services - DAB

1. Certain radio stations have one or more secondary services associated with them. If a station has a secondary service associated with it then the secondary service will be shown directly after the primary service as you press the **Tuning Up button**.
2. Press and release the **Select button** to select the station.

Most secondary services do not broadcast continually and if the selected service is not available the radio will re-tune to the associated primary service.

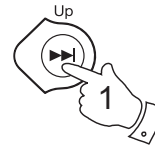
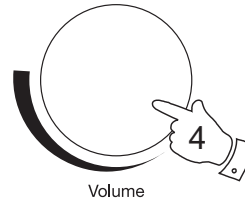
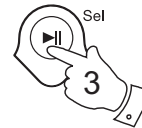
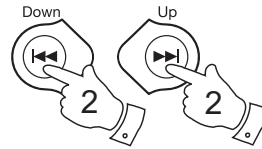

Display modes - DAB

Your radio has a range of display modes:-

1. Press the **Info button** to cycle through the various modes.



- a. Scrolling text Displays scrolling text messages such as artist/track name, phone in number, etc.

- b. Programme type Displays type of station being listened to e.g. Pop, Classic, News, etc.

- c. Multiplex Name Displays name of multiplex to which current station belongs.

- d. Time Displays current time.

- e. Frequency Displays the current frequency.

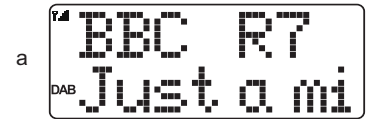

Display modes - DAB cont.

f. Bit rate Displays the digital bit rate.



g. Signal error Displays the signal error for the station being listened to. (The lower numbers mean that the radio is receiving a better signal).



Finding new stations - DAB

As time passes new stations may become available. To find new stations proceed as follows:-

1. Press and hold the **Tuning Up or Down buttons**, the display will show "Scan...". Your radio will perform a scan of the UK DAB frequencies. As new stations are found the station counter on the right-hand side of the display will increase and stations will be added to the list.
2. To carry out a full scan of the entire DAB Band III frequencies press and hold down the **Menu button**. Then press the **Tuning Up or Down buttons** until the display shows 'SELECT Scan'.
3. Press and release the **Select button** the display will show "Scan...". As new stations are found the station counter on the right-hand side of the display will increase and stations will be added to the list.

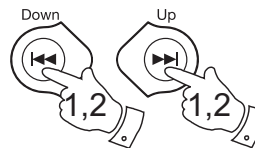

Manual Tuning - DAB

Manual tuning allows you to tune directly to the various DAB (Band III) channels. UK DAB stations are located in the range 11B to 12D.

1. Press and hold the **Menu button** so that the display shows "SELECT Manual".
2. Press and release the **Select button**.
3. Press the **Tuning Up** or **Down buttons** to select the required DAB channel. (Frequency display is in MHz).
4. Press and release the **Select button**. The signal indicator in the top left corner shows the signal strength received.
5. Press the **Select button** twice to select the station and to return to normal tuning.
6. When a DAB signal is found, the display will show the name of the station. Any new radio stations found will be added to the list stored in the radio.
7. Press the **Select button** to exit. The radio may then display 'Stt Serv' (Select Service). Press the **Tuning Up** or **Down buttons** followed by the **Select button** to choose a radio station to listen to.

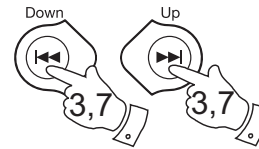
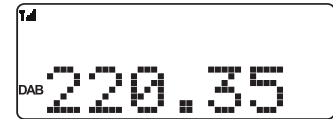
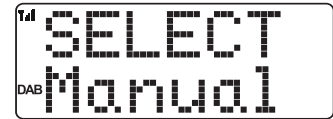

Dynamic Range Control (DRC) settings - DAB only

DRC can make quieter sounds easier to hear when your radio is used in a noisy environment. This function is only for the DAB waveband.

1. Switch the unit on by rotating the **Function switch** to the Radio position.
2. Slide the **DAB/FM switch** to the 'DAB' position. 'DAB' will show on the display.
3. Press and hold the **Menu button** until 'SELECT Manual' appears on the display.
4. Press and release the **Tuning Up or Down buttons** until the display shows 'SELECT DRC'.
5. Press and release the **Select button** to enter adjustment mode.
6. Press and release the **Tuning Up or Down buttons** to select required DRC setting (default is 0) .
 - DRC 0 DRC is switched off, Broadcast DRC will be ignored.
 - DRC 1/2 DRC level is set to 1/2 that sent by broadcaster.
 - DRC 1 DRC is set as sent by broadcaster.
7. Press and release the **Select button** to confirm the setting. The display will return to radio mode.

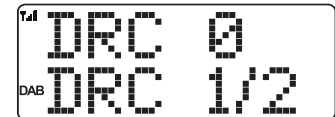
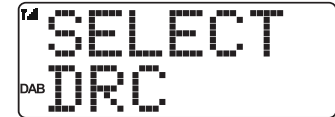
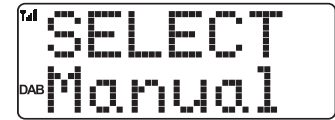
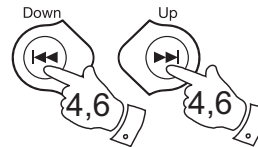

Operating your radio - Search tuning FM

1. Carefully extend the telescopic aerial (see page 4).
2. Switch on the unit by rotating the **Function switch** to the Radio position. The 'On' indicator will light.
3. Slide the **DAB/FM switch** to the 'FM' position, 'FM RADIO' will appear in the display.
4. Press and hold the **Tuning Up button** your radio will scan in an upwards direction (low frequency to high frequency) and stop automatically when it finds a station of sufficient strength.
5. After a few seconds the display will update. The display will show the frequency found. If the signal is strong enough and there is RDS data present then the radio will display the station name.
6. To find other stations press and hold the **Tuning Up button** as before.
7. To scan the FM band in a downwards direction (high frequency to low frequency) press and hold the **Tuning Down button**.
8. When the waveband end is reached your radio will recommence tuning from the opposite waveband end.
9. Adjust the **Volume** to the required settings.
10. To switch off your radio rotate the **Function switch** to the 'Off' position.

Off CD SD Radio

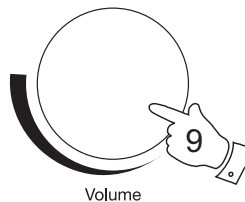
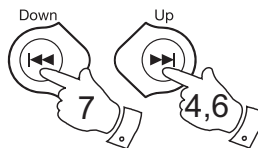

Off CD SD Radio



Manual tuning - FM

1. Carefully extend the telescopic aerial (see page 4).
2. Switch on the unit by rotating the **Function switch** to the Radio position. The 'On' indicator will light.
3. Slide the **DAB/FM switch** to the 'FM' position, 'FM RADIO' will appear in the display.
4. Repeatedly press the **Tuning Up** or **Down buttons** to tune to a station. The frequency will change in steps of 50kHz on FM.
5. When the waveband end is reached the radio will recommence tuning from the opposite waveband end.
6. Set the **Volume** to the desired settings.
7. To switch off your radio rotate the **Function switch** to the 'Off' position.

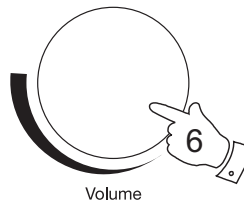
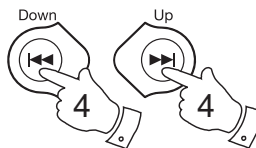

Display modes - FM

Your ZoomBox has a range of display options when in FM mode. The Radio Data System (RDS) is a system in which inaudible digital information is transmitted in addition to the normal FM radio programme. RDS offers several useful features.



1. Press the **Info button** to cycle through the various modes.

- | | |
|-------------------|----------------------------------------------------------------------------------|
| a. Scrolling text | Displays scrolling text messages such as artist/track name, phone in number etc. |
| b. Programme Type | Displays type of station being listened to e.g. Pop, Classic, News, etc. |
| c. Time | Displays current time. |
| d. Frequency | Displays frequency of the station being listened to. |

Note: If no RDS information is available, the radio will be unable to display the station name, scrolling text and programme type.

If the radio cannot display the programme type it may display 'NO PTY'.

If the radio cannot display the time it may display 'NO CT'.



FM stereo / mono

1. If an FM station is received with a weak signal some hiss may be audible. To reduce the hiss press and hold the **Select button** the display will show 'Mono'. Your radio will switch to mono mode.
2. To return to stereo mode press and hold the **Select button** the display will show 'Auto'. The radio will switch to stereo mode.



Presetting stations

There are 20 memory presets on each of the DAB and FM wavebands.

1. Switch on the unit by rotating the **Function switch** to the Radio position.
2. Switch to the desired waveband and tune to the required station as previously described.
3. Press the **Memory Up** or **Down buttons** to select the desired preset number under which you wish to store the station.
4. Press and hold down the **Stop / Memory button** until the display shows e.g. 'P2 saved'. The station will be stored under the chosen preset. Repeat this procedure for the remaining presets.
5. Stations stored in preset memories may be overwritten by following the above procedure.

Off CD SD Radio



Down Album Up
Memory



Recalling a preset station

1. Switch on the unit by rotating the **Function switch** to the Radio position.
2. Select the required waveband as previously described.
3. In FM mode, momentarily press the **Memory Up** or **Down buttons** to recall the stored preset station. The display will show the preset number e.g. 'Preset 1'.

In DAB mode, press the **Memory Up** or **Down buttons** to recall the stored station preset. The display will show the station name of the preset station.

4. Your radio will then tune to the station stored in the chosen preset memory.

If no station has been stored in memory the display shows e.g. 'Empty 1' when pressing the **Memory Up** or **Down buttons**.

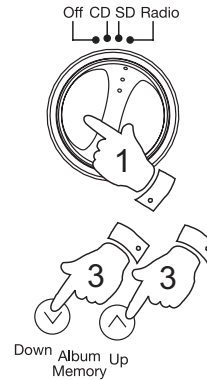

Compact discs

Use only Digital Audio CDs which have the  symbol.

Never write on a CD or attach any sticker to the CD. Always hold the CD at the edge and store it in its box after use with the label facing up.

To remove dust and dirt, breathe on the CD and wipe it with a soft, lint free cloth in a straight line from the centre towards the edge.

Cleaning agents may damage the CD.

Do not expose the CD to rain, moisture, sand or to excessive heat. (e.g from heating equipment or in motor cars parked in the sun).

CD-R/CD-RW discs

Your CD player can playback CD-DA format audio CD-R/CD-RW discs that have been finalised* upon completion of recording.

Your CD player may fail to playback some CD-R/CD-RW discs due to poor recording and wide variation in quality of the CD-R/CD-RW disc.

*Finalising enables a CD-R/CD-RW disc to playback on audio players such as your ZoomBox.

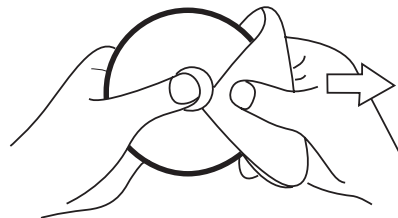

WARNING

CLASS 1 LASER PRODUCT means that the laser's construction makes it inherently safe so that the legally prescribed maximum permissible radiation values can never be exceeded.

Caution: Using any equipment or devices other than those described and specified in these operating instructions, or tampering with the unit in any way, can result in dangerous exposure to radiation.



MP3 / WMA CD Mode

The ZoomBox is able to play CD-R and CD-RW discs containing MP3 / WMA files.

In MP3 / WMA mode the terms “album” and “file” are very important. “Album” typically corresponds to a folder on a PC, “File” to a PC or a CD-DA track. The device reads MP3 or WMA files with a maximum of 255 files per album or folder. An MP3 / WMA CD may not contain more than a combined total of 511 files and folders. MP3 and WMA files must be created with an audio sample rate of 44.1kHz (this is normal for files created from CD audio content). Folders may be nested but to a maximum of 8 levels. Folder and file names should be less than 30 characters (longer names are possible but reduce the above maximum limits). ID3 tags for title / artist / album should be less than 30 characters (longer tags are possible, but are truncated when displayed). Within any one folder, files or folders written earlier will have higher priority than those written later. Within any one folder, files have higher priority than nested folders. The priority of folders when playing is based on the level in the directory tree. The higher level the higher priority.

When burning CD-R and CD-RW discs with audio files, various problems may arise which could lead to interference in playback. This can be caused by faulty software or hardware settings or by the CD being used. Should such problems arise, contact the customer services of your CD burner or software manufacturer or look for relevant information, for example on the internet. When you are making audio CDs, observe all legal guidelines and ensure that the copyright of third parties is not infringed.

Inserting a CD

1. To open the CD compartment, push the **OPEN/CLOSE button** on the top panel.
2. Put the CD on the spindle until it clicks into place and close the CD door.



Playing a CD

1. Rotate the **Function switch** to choose CD as the input source.

The CD player will scan the contents of the CD, "READING" will appear on the display.

Audio CD: the total number of tracks and total playing time will appear on the display.

MP3 / WMA CD: The total number of files and folders will appear on the display.

2. Press the **Play/Pause button** to start playback. The display will show the first track number and the play symbol ► will appear on the display.

Audio CD: The current track number and elapsed playing time.

MP3 / WMA CD: The current file number for 3 seconds, then change to show the file name, ID3 tag and the elapsed playing time.

3. Adjust the **Volume** to the required settings.

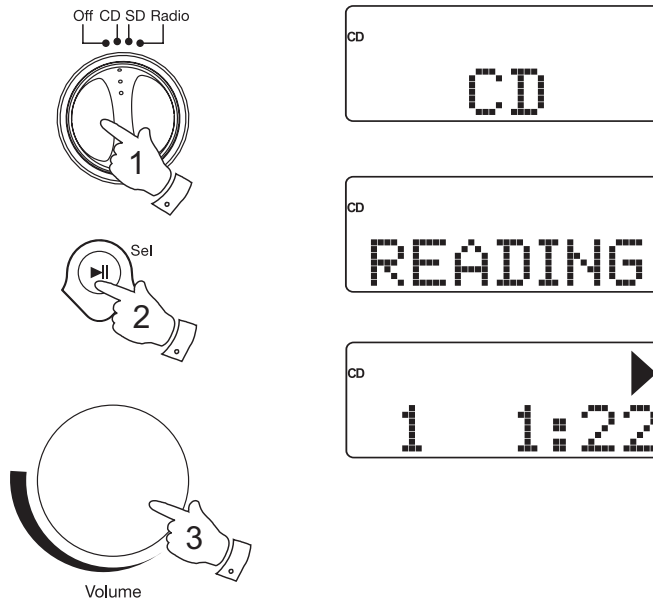

- To pause playback press the **Play/Pause button**, the pause symbol **||** will appear on the display.

The current track number and the elapsed playing time stay on the display.



- To resume playback press the **Play/Pause button** again.

- To stop playback, press the **Stop button**.

To take out the CD, push the **OPEN/CLOSE button** on the top panel of the device. The CD door should only be opened when the CD is in stop mode.

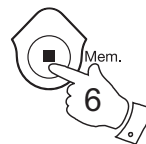

Selecting a track

- Audio CD: Whilst the CD is playing, press either the **Fastforward or Rewind buttons** to change the desired track. You can skip tracks when the player is in stop mode. Press the **Play/Pause button** to play the selected track.

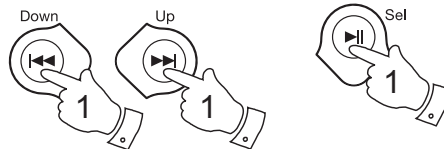

- MP3 / WMA CD: Whilst the CD is playing, press either the **Album/ Memory Up or Down buttons** to change to the desired album, then press either the **Tuning Up or Down buttons** to change to the desired track. You can also skip albums or tracks when the player is in stop mode. Press the **Play/Pause button** to play the selected track.

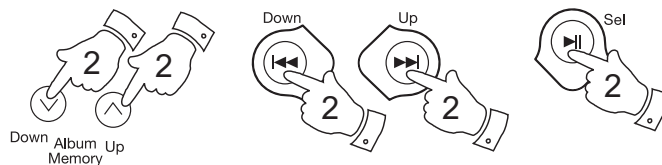

Search function

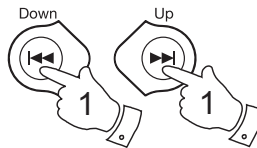

1. Whilst the CD is playing, press and hold down either the **Tuning Up** or **Down buttons**. Release the button when the desired part of the track is reached.



CD repeat mode

1. Whilst the CD is playing press the **Mode button**.

Audio CD: Repeat 1 , → Repeat ALL , → Random **RAN**
→ Normal Play

MP3 / WMA: Repeat 1 , → Repeat Album/Folder ,
→ Repeat ALL , → Random **RAN** → Normal Play

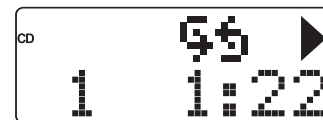
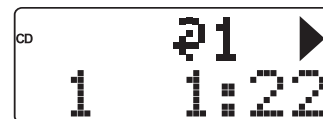

CD Random play

1. Whilst the CD is playing, repeatedly press the **Mode button** to play all tracks on the CD in random order. 'RAN' will appear on the display. The tracks are played in random order until all tracks have been played.
2. Press the **Mode button** again to return to normal play. 'RAN' disappears from the display.

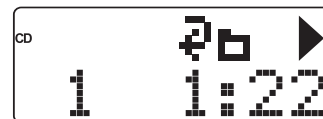

CD Intro mode

1. When in the stop mode, press the **Mode button** twice to play the first 10 seconds intro of all the tracks on the disc. 'Intro' appears on the display.
2. To cancel intro, press the **Stop button**.

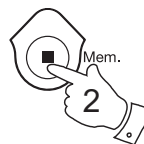

Creating a play list (Programme Play - CD & SD only)

By programming the player you can play up to 60 tracks in any desired order.

1. Whilst the CD is in Stop mode, press and release the **Mode button**. The display will show 'P-01'.
CDDA: Select the first track using the **Fastforward** or **Rewind buttons**. "MEM" will flash on the display. Store this track by pressing the **Mode button**.
2. Repeat the above steps until you have completed your programme.
3. Press the **Play/Pause button** to commence play of selected tracks.

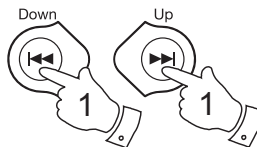

Checking and Editing a programme

Whilst the CD is in stop mode, you can check and edit the programme.

1. Press and release the **Mode button**. The display will show the play list that you have have already programmed.
2. You can edit the playlist. When the desired track that you want to edit is reached, follow the procedure for creating a playlist page above.



Erasing a programme

1. Press the **Stop button** to erase the program. Programmes are also erased by switching to off, radio or SD mode.

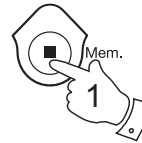

Using SD cards

Secure Digital (SD or SDHC) cards can be used with the ZoomBox for playback of MP3 or WMA files.

The ZoomBox has been tested with a range of SD cards. SD cards up to 2GB and SDHC cards up to 16GB are supported. However, there are many different card variants available and not all cards can be guaranteed to work in the ZoomBox. SD/SDHC cards must be formatted using the FAT or FAT32 filing system in order to operate with the ZoomBox.

SD card slot is located at the front of the unit.

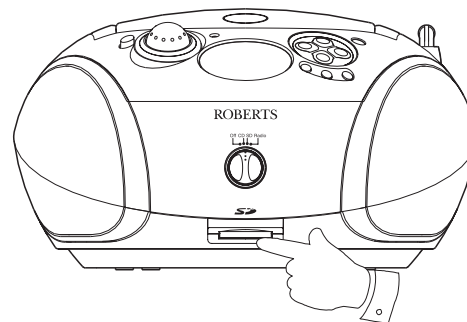

Inserting and removing a card

To insert an SD card into your ZoomBox push the card **label side upwards** and **gold contacts first** into the SD card slot on the front of your CD player until it clicks.

To remove the card push the card in slightly and it will pop out allowing removal.

1. To select SD card mode rotate the **Function switch** to 'SD'.

Playback control in SD card mode is similar to CD MP3 / WMA mode see page 19. MP3 / WMA files are played back in the order that they are written to the SD card by your computer, except when Random mode is used.

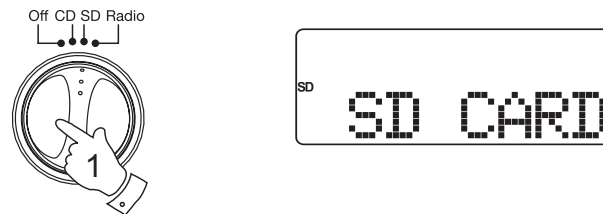

Software version

The software display cannot be altered and is just for your reference.

1. To view which software version your ZoomBox has ensure your CD player is in DAB or FM mode and press and hold the **Menu button** to enter the menu setup.
2. Press the **Tuning Up** or **Down buttons** until 'Version' together with the Version number appears on the display.

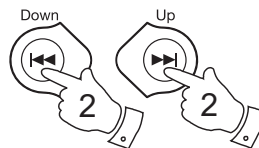

Zoom display function

Your CD player has a zoom button which can be used to enlarge the size of fonts on the display.

1. Press the **Zoom button** to enlarge the upper line of the display.
2. Press the **Zoom button** again to enlarge the lower line of the display.
3. Press the **Zoom button** once more to return to the normal two-line display.

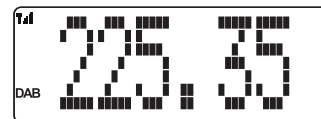
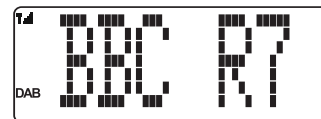
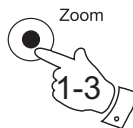

Deep Bass Boost

1. Press the **Deep Bass Boost button** to enhance bass sounds.
2. Press the **Deep Bass Boost button** again to return to normal sound.



System Reset

If your radio fails to operate correctly, or some digits on the display are missing or incomplete, carry out the following procedure.

1. Whilst in DAB mode press and hold the **Menu button** and then repeatedly press the **Tuning Up** or **Down buttons** until the display shows 'SELECT Factory'.
2. Press and release the **Select button**, 'Confirm Reset' will be displayed. Press the **Select button** again to confirm reset.

A full reset will be performed and the station list together with any preset stations will be erased.

In case of malfunction for any reason, just reset the product to resume normal operation. It may be necessary in some cases to disconnect the mains power and remove batteries, then reconnect after 10 seconds.

In case of malfunction due to electrical fast transient (Burst), just reset the product (reconnect of power source may be required) to resume normal operation.

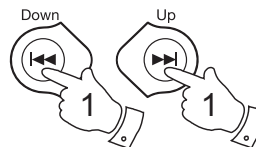

Headphone socket

1. A 3.5mm **Headphone Socket** located on the left hand side of your radio is provided for use with headphones. Inserting a plug automatically mutes the internal loudspeaker.

IMPORTANT: Excessive sound pressure from earphones and headphones can cause hearing loss.

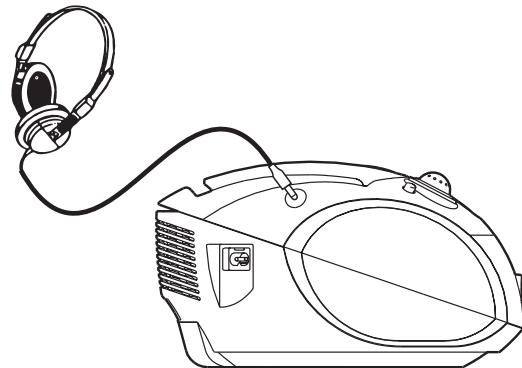

Mains supply

The ZoomBox will operate from a supply of AC 230 volts, 50Hz  only.

DO NOT cut off the mains plug from this equipment. If the plug fitted is not suitable for the power points in your home or the cable is too short to reach a power point, then obtain an appropriate safety approved extension lead or adaptor. If in doubt consult your dealer.

If nonetheless the mains plug is cut off, remove the fuse and dispose of the plug immediately to avoid a possible shock hazard by inadvertent connection to the mains supply.

If this product is not supplied with a mains plug, or one has to be fitted, then follow the instructions given below:

IMPORTANT. DO NOT make any connection to the larger terminal which is marked with the letter E or by the safety earth symbol  or coloured Green or Green-and-yellow.

The wires in the mains lead are coloured in accordance with the following codes :-

BLUE - NEUTRAL

BROWN - LIVE

The wire coloured BLUE must be connected to the terminal marked N or coloured BLACK.

The wire coloured BROWN must be connected to the terminal marked L or coloured RED.

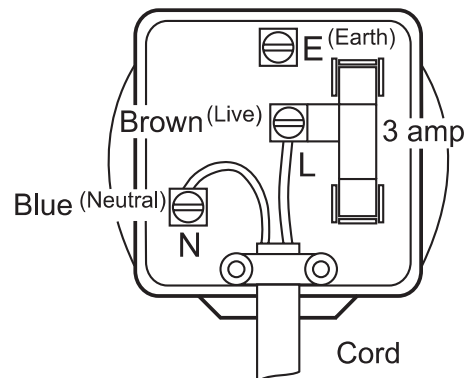

Fuse

When replacing the fuse only a 3A ASTA approved to BS1362 type should be used and be sure to re-fit the fuse cover.

IF IN DOUBT - CONSULT A QUALIFIED ELECTRICIAN.

Replacement fuse holders are available from Roberts Radio Technical Services at the address shown on the rear of this manual.

General

Do not allow this CD player to be exposed to water, steam or sand. Do not leave your CD player where excessive heat could cause damage. It is recommended that the DAB band be used wherever possible as better results in terms of quality and freedom from interference will usually be obtained than on the FM band.

- The name plate is located on the underside of your CD player.

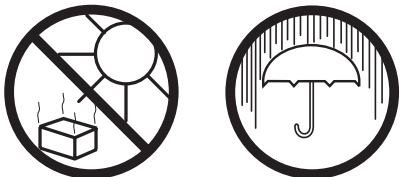

- The apparatus shall not be exposed to dripping or splashing and that no objects filled with liquids, such as vases, shall be placed on the apparatus.
- It is recommended to operate the product such that there is a minimum distance (10cm recommended) to adjacent objects in order to ensure good ventilation.
- The ventilation of the product should not be restricted by covering it or its ventilation openings with items such as newspapers, table-cloths, curtains etc.
- No naked flame sources such as lighted candles should be placed on the product.
- It is recommended to avoid using or storing the product at extremes of temperature. Avoid leaving the unit in cars, on window sills in direct sunlight etc.

Specifications

Power Requirements

Mains	AC 230 volts, 50Hz \sim only
Battery	6 x LR14 (C size)

Battery life 25 - 35 hours depending on operating mode.

Frequency Coverage

FM	87.5-108MHz
DAB	174.928 - 239.200MHz

Circuit features

Loudspeaker	2 x 76 mm 8 ohms
Power output	2 x 1 Watt
Headphone socket	3.5mm dia
Aerial System	FM Telescopic aerial
	DAB Telescopic aerial

The Company reserves the right to amend the specification without notice.

Guarantee

This instrument is guaranteed for twelve months from the date of delivery to the original owner against failure due to faulty workmanship or component breakdown, subject to the procedure stated below. Should any component or part fail during this guarantee period it will be repaired or replaced free of charge.

The guarantee does not cover:

1. Damage resulting from incorrect use.
2. Consequential damage.
3. Receivers with removed or defaced serial numbers.

N.B. Damaged or broken telescopic aerials will not be replaced under guarantee.

Procedure:

Any claim under this guarantee should be made through the dealer from whom the instrument was purchased. It is likely that your Roberts' dealer will be able to attend to any defect quickly and efficiently but should it be necessary the dealer will return the instrument to the Company's service department for attention. In the event that it is not possible to return the instrument to the Roberts' dealer from whom it was purchased, please contact Roberts Radio Technical Services at the address shown overleaf.

These statements do not affect the statutory rights of a consumer.

ROBERTS RADIO TECHNICAL SERVICES

97-99 Worton Road

Isleworth

Middlesex

TW7 6EG

Technical Helpline :- 020 8758 0338 (Mon-Fri during office hours)

Website: <http://www.robertsradio.co.uk>



Issue 1

© 2009 Roberts Radio Limited

Download from [Www.Somanuals.com](http://www.Somanuals.com). All Manuals Search And Download.

Free Manuals Download Website

<http://myh66.com>

<http://usermanuals.us>

<http://www.somanuals.com>

<http://www.4manuals.cc>

<http://www.manual-lib.com>

<http://www.404manual.com>

<http://www.luxmanual.com>

<http://aubethermostatmanual.com>

Golf course search by state

<http://golfingnear.com>

Email search by domain

<http://emailbydomain.com>

Auto manuals search

<http://auto.somanuals.com>

TV manuals search

<http://tv.somanuals.com>