

ROBERTS

Sound for Generations

SRC985

3 Band Mains Battery
Stereo Radio Cassette Recorder

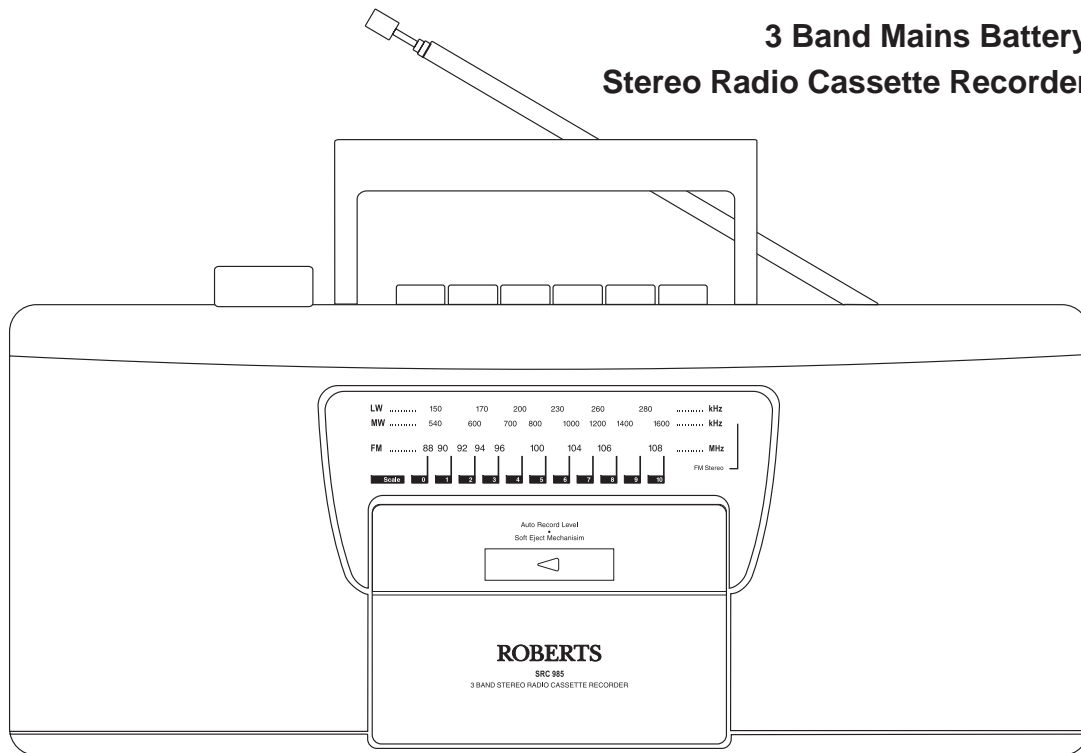

Please read this manual before use

Controls

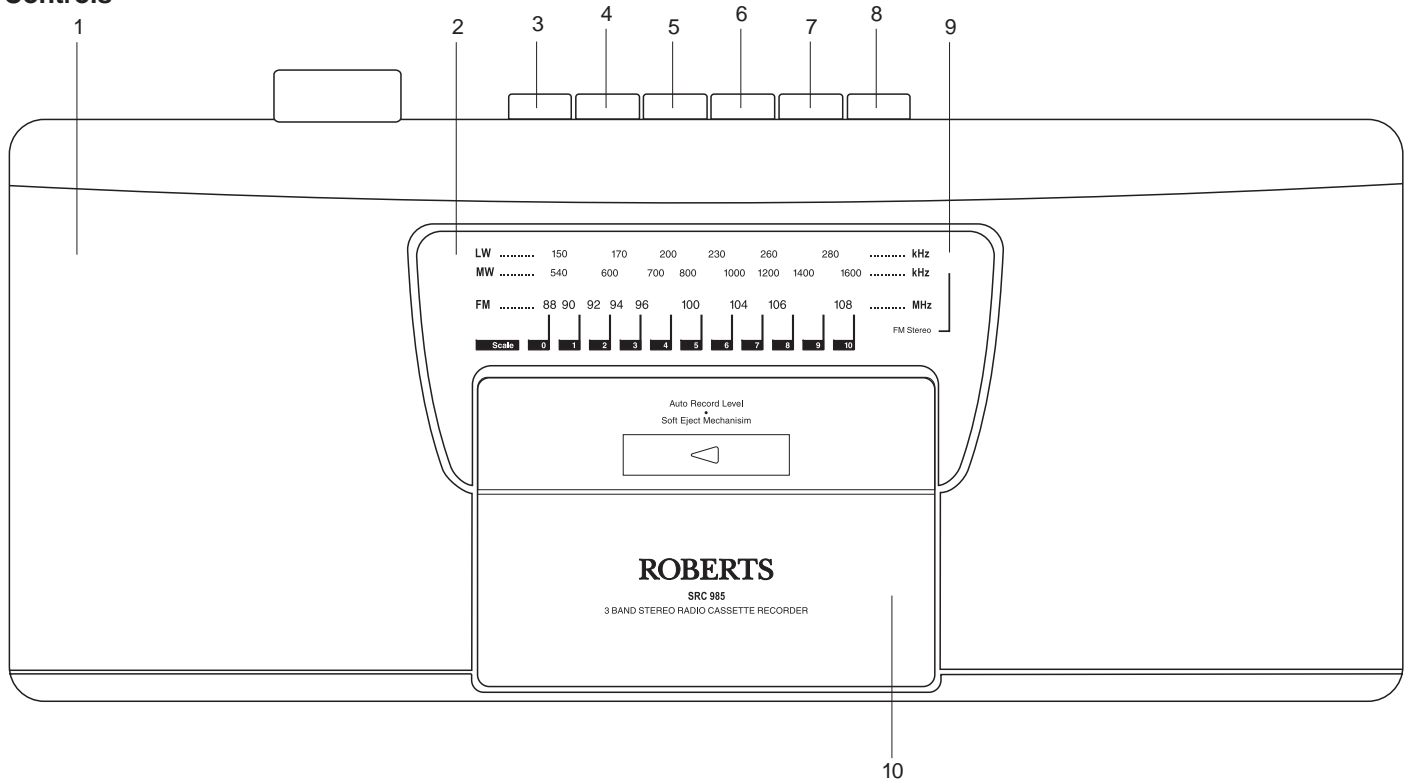

1. Built in microphone
2. Tuning dial
3. Pause button
4. Stop/Eject button

5. Fast forward button
6. Rewind button
7. Play button
8. Record button

9. Stereo indicator
10. Cassette compartment

If you need any further advice, please call our Technical Helpline on 020 8758 0338 (Mon-Fri)

Controls (cont.)

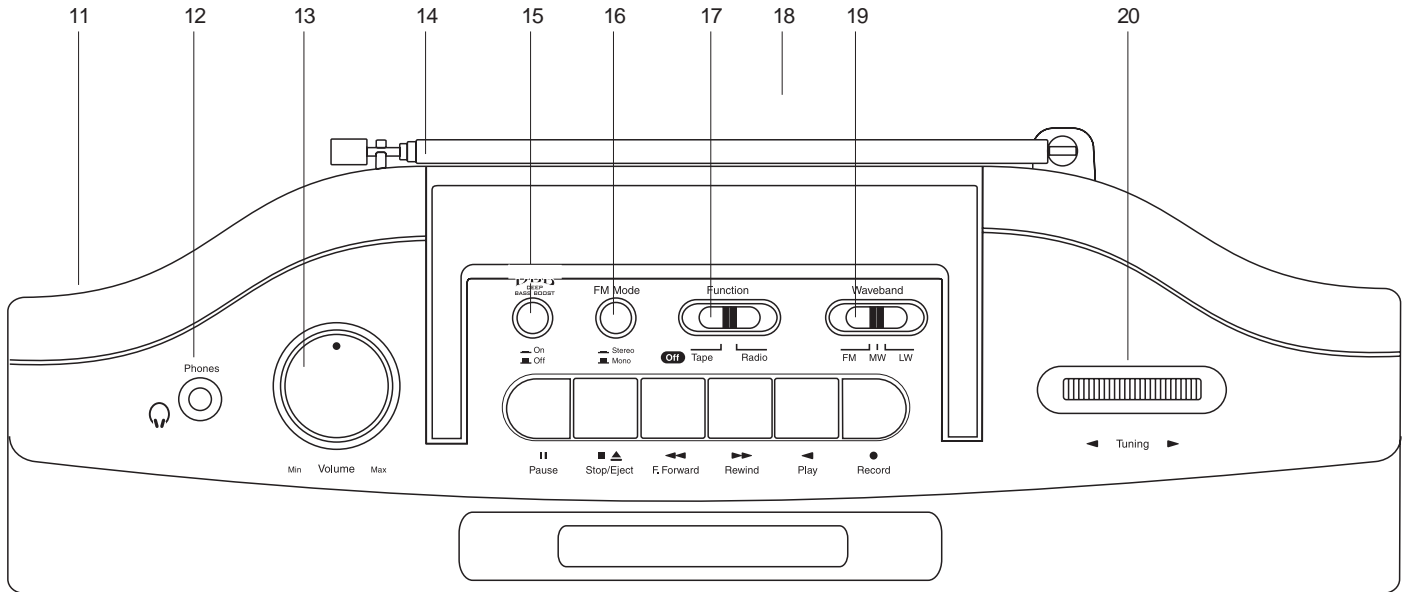

- 11. Mains input socket (on rear)
- 12. Headphone socket
- 13. Volume control
- 14. Telescopic aerial

- 15. DBB (Deep Bass Boost) button
- 16. FM mode button (mono/stereo)
- 17. Function selector switch
- 18. Battery compartment (on rear)

- 19. Waveband select switch
- 20. Tuning control

General

Do not allow this unit to be exposed to water, steam or sand. Do not leave the unit where excessive heat could cause damage such as in a parked car where the heat from the sun can build up even though the outside temperature may not seem too high. It is recommended that the FM band be used wherever possible as better results in terms of quality and freedom from interference will usually be obtained than on the MW or LW bands.

Mains supply

The SRC985 will operate from a supply of AC 230 volts, 50Hz  only.

For your convenience this product is supplied with a plug which is fitted with a fuse of the appropriate rating. If the plug supplied is not suitable for your socket outlet, it should be removed by unscrewing the plug top, the terminal screws, and removing the cable.

The correct style of plug to suit your household together with a correctly rated fuse should be fitted.

IF IN DOUBT - CONSULT A QUALIFIED ELECTRICIAN

IMPORTANT. DO NOT make any connection to the larger terminal which is marked with the letter E or by the safety earth symbol  or coloured Green or Green-and-yellow.

The wires in the mains lead are coloured in accordance with the following codes :-

BLUE - NEUTRAL

BROWN - LIVE

As these colours may not correspond with the coloured markings identifying the terminals in your plug, proceed as follows:

The wire coloured BLUE must be connected to the terminal marked N or coloured BLACK.

The wire coloured BROWN must be connected to the terminal marked L or coloured RED.

If you need any further advice, please call our Technical Helpline on 020 8758 0338 (Mon-Fri)

Fuse

This apparatus must be protected by a 3A fuse (BS1362) in a 13A plug (BS1363). If another type of plug is used a 5A fuse should be fitted in the plug, adaptor or distribution board.

IF IN DOUBT - CONSULT A QUALIFIED ELECTRICIAN.

Batteries

Remove the battery cover (18) on the rear of the unit by pushing the catches in the direction of the arrows. Insert five IEC size LR14 batteries (c size) into the compartment. Take care to ensure all batteries are inserted with the correct polarity as shown inside the battery compartment. Replace the battery cover.

Reduced power, distortion, and a 'stuttering' sound are all signs that the batteries may need replacing.

We would recommend for economy, that the SRC985 is used on the mains whenever possible with battery operation for occasional or stand-by use only.

Automatic Mains/Battery switching

To change from battery to mains operation, simply plug the mains lead into the mains input socket (11) on the rear of the unit. The batteries will be automatically disconnected. It does not matter which way round the plug is inserted but make sure it is fully pushed home. The other end should be plugged into a domestic supply socket.

FM stereo operation

Set the function switch (17) to the 'Radio' position. Set the waveband select switch (19) to the 'FM' position. Set the FM mode button (16) to the 'Stereo' (down) position. Adjust the volume control (13) until a hissing sound is heard. The telescopic aerial (14) which is only operational on FM, should be fully extended. Carefully tune to the desired station using the tuning control (20). If the station being received is in 'Stereo' the stereo indicator (9) will illuminate. Angle and rotate the telescopic aerial to a position giving the best reception. A knuckle joint at the base of the aerial allows this movement and an angle of 45 degrees will usually be satisfactory. If the FM signal becomes weak or is accompanied by a high level of background hiss, you may select 'MONO' mode by setting the FM mode button (16) to the 'Mono' (up) position.

The FM band is marked in Megahertz (MHz). To switch off the radio, set the function switch (17) to the 'Off/Tape' position.

Medium and long wave operation

Set the function switch (17) to the 'Radio' position. Select 'MW' or 'LW' using the waveband select switch (19). Adjust the volume control (13) until a hissing sound is heard. Carefully tune to the desired station using the tuning control (20). The unit should be rotated for optimum reception. The MW and LW bands are marked in kilohertz (kHz). To switch off the radio, set the function switch (17) to the 'Off/Tape' position.

Listening to cassette tapes

Set the function switch (17) to the 'Off/Tape' position. Press the stop/eject button (4) to open the cassette compartment (10). Insert a pre-recorded cassette with the tape surface uppermost and the side with the desired recording facing towards you. Close the cassette compartment. Depress the play button (7) and adjust the volume control (13) to suit your personal taste. Use the fast forward (5) or rewind buttons (6) to locate a specific part of the tape. If you wish to temporarily stop the playback depress the pause button (3). When you are ready to resume playback press the pause button a second time.

Recording from the Radio

Set the Function switch (17) to the 'Radio' position. Tune in to the desired station. Adjust the volume control (13) to suit your requirements. Insert a blank cassette with the tape surface uppermost. Depress the record button (8) to commence recording. The recording level is set automatically and is not affected by the setting of the volume control.

Recording from the Internal Microphone

Set the function switch (17) to the 'Off/Tape' position. Insert a blank cassette with the tape surface uppermost. Press the record button (8) to commence recording.

Note : *To reduce background noise it is important to speak as close as possible to the internal microphone (1).*

Caution

If the record button will not depress, do not force it. It is probably because the cassette tabs have been broken to prevent accidental erasure of an existing recording. (see preventing accidental erasure)

Preventing accidental erasure

To safeguard your recordings against accidental erasure, break off the appropriate tab on the cassette as shown. There is one tab for each side of the cassette. This will prevent the Record button from being pressed. To restore the cassette to normal, seal the tab openings with a small piece of self-adhesive tape.

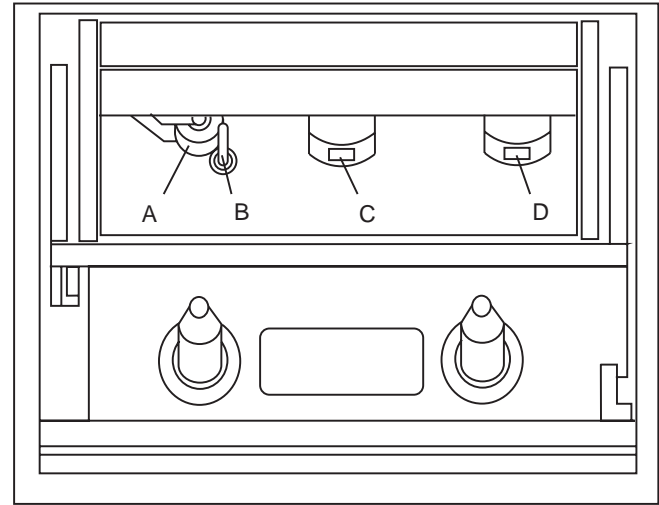
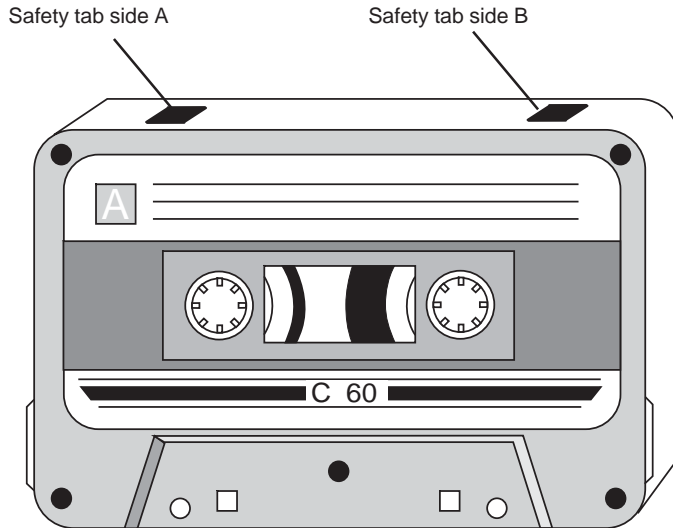

Cleaning the Heads

The binder and oxide from magnetic tapes can accumulate on the pinch roller (A) the capstan shaft (B) and also the heads (C and D). This will impair the sound quality.

To clean these parts proceed as follows:-

1. Turn off the power to the unit
2. Press the Stop/eject button (4).
3. Press the Play button (7), and the heads will be clearly seen.
4. Clean the surfaces (A, B, C, D) with a lint free rag or cotton swab soaked in alcohol. Press the Stop/eject button as soon as cleaning is over.

If you need any further advice, please call our Technical Helpline on 020 8758 0338 (Mon-Fri)

Specifications

Power Requirements

Mains : AC 230 volts , 50Hz  only
Batteries : 5 x IEC LR14 (C size) batteries

Battery Life

Approx. 40hrs of listening for 4 hours a day at normal volume, using Alkaline batteries.

Frequency Coverage

FM 87.5-108MHz
MW 525 - 1620kHz
LW 148 - 284kHz

Circuit Features

Loudspeakers 2 x 75mm dia 8ohms

Output Power 2 x 1.0 watt RMS

Headphone socket 3.5mm dia

Aerial System FM Telescopic aerial

MW Built-in Ferrite aerial

LW Built-in Ferrite aerial

Imported by:-

ROBERTS RADIO LIMITED

PO BOX 130

MEXBOROUGH

SOUTH YORKSHIRE

S64 8YT

The Company reserves the right to amend the specification without notice.

Guarantee

This instrument is guaranteed for twelve months from the date of delivery to the original owner against failure due to faulty workmanship or component breakdown, subject to the procedure stated below. Should any component or part fail during this guarantee period it will be repaired or replaced free of charge.

The guarantee does not cover:

1. Damage resulting from incorrect use.
2. Consequential damage.
3. Receivers with removed or defaced serial numbers.

N.B. Damaged or broken telescopic aerials will not be replaced under guarantee.

Procedure:

Any claim under this guarantee should be made through the dealer from whom the instrument was purchased. It is likely that your Roberts' dealer will be able to attend to any defect quickly and efficiently, but should it be necessary the dealer will return the instrument to the company's service department for attention. In the event that it is not possible to return the instrument to the Roberts' dealer from whom it was purchased, please contact Roberts Radio Technical Services Department at the address shown below before taking further action.

These statements do not affect the statutory rights of a consumer.

ROBERTS RADIO TECHNICAL SERVICES DEPARTMENT

97-99 Worton Road
Isleworth Middlesex
TW7 6EG

Technical Helpline:-020 8758 0338

Issue 2



Free Manuals Download Website

<http://myh66.com>

<http://usermanuals.us>

<http://www.somanuals.com>

<http://www.4manuals.cc>

<http://www.manual-lib.com>

<http://www.404manual.com>

<http://www.luxmanual.com>

<http://aubethermostatmanual.com>

Golf course search by state

<http://golfingnear.com>

Email search by domain

<http://emailbydomain.com>

Auto manuals search

<http://auto.somanuals.com>

TV manuals search

<http://tv.somanuals.com>