

# ROBERTS

Sound for Generations

## CR9923

2 Band Single Alarm  
Clock Radio

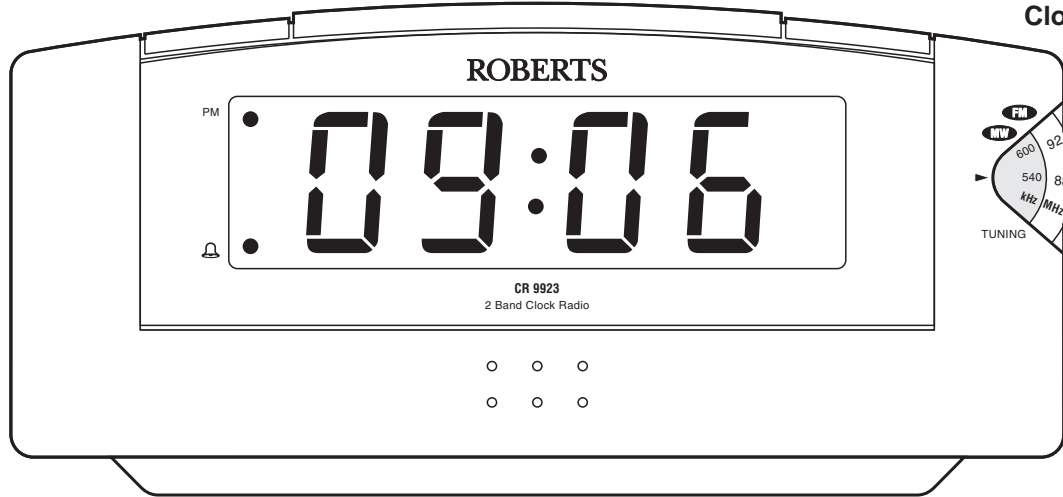

Please read this manual before use

## Controls (top)

1. Alarm set/off button.
2. Sleep button.
3. Minute button.
4. Hour button.
5. Time set button.
6. Snooze.

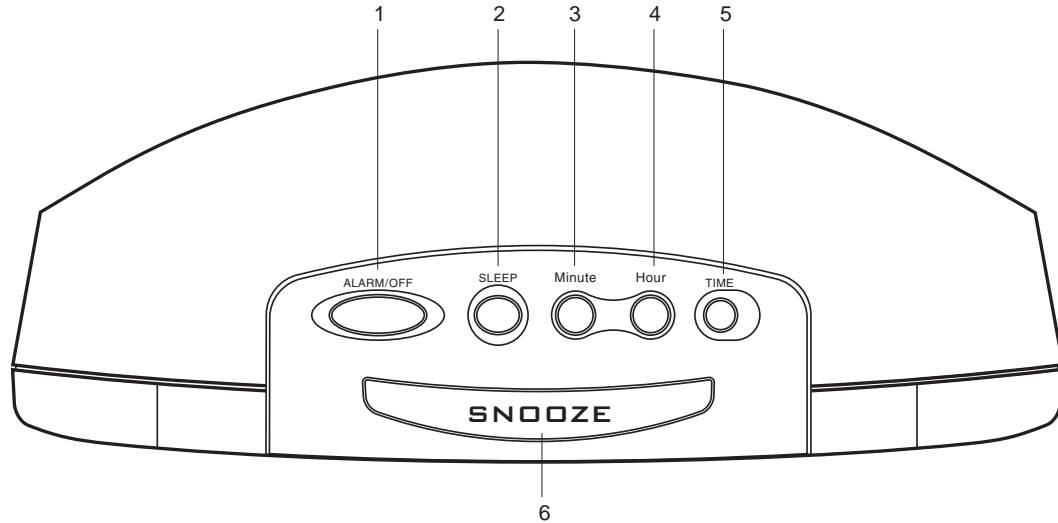

## Controls (front)

- 6. Alarm indicator.
- 7. PM indicator.
- 8. Tuning control.

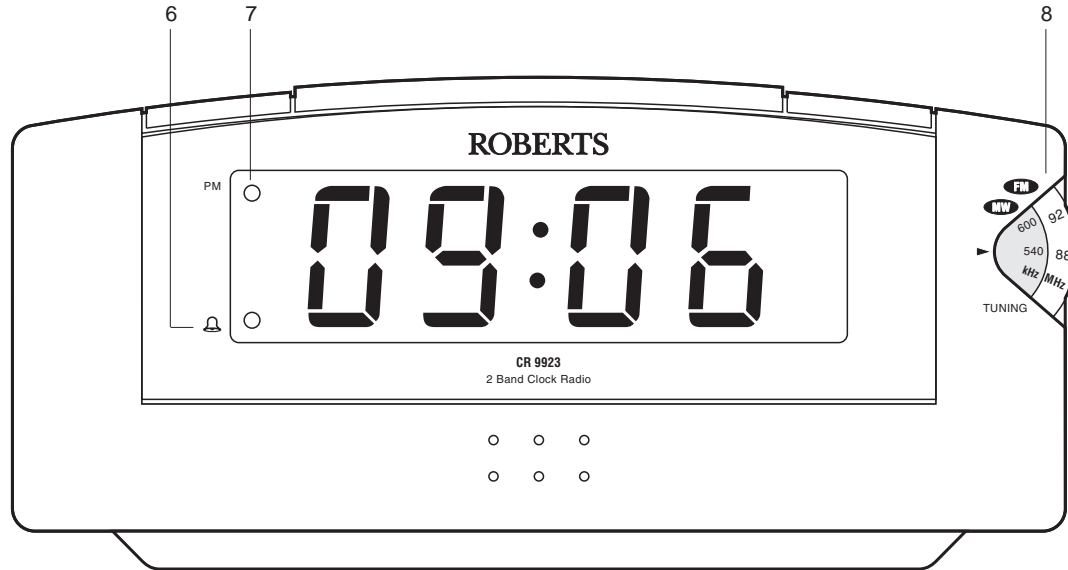

If you need any further advice, please call our Technical Helpline on :-  
020 8758 0338 (Mon-Fri)

## Controls (left and right side)

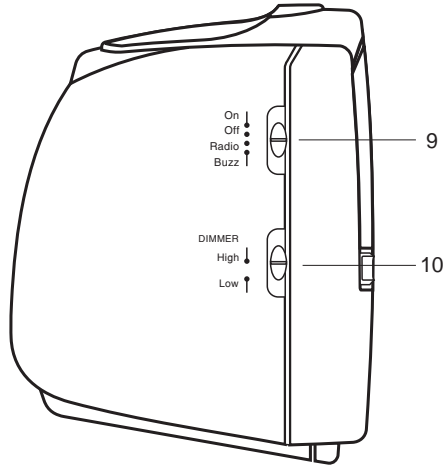

- 9. Function switch.
- 10. Dimmer switch.
- 11. Waveband switch.
- 12. Volume control.
- 13. Battery compartment

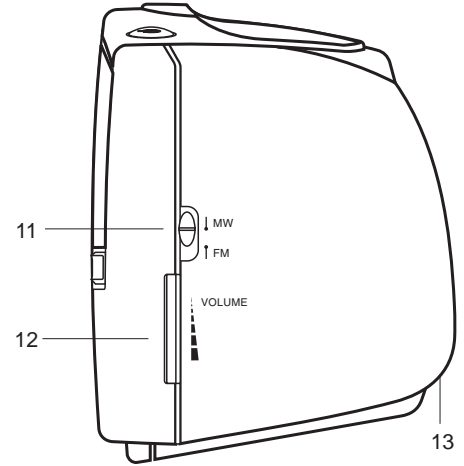

## Switching on

1. Place your clock radio on a flat surface. Plug the power cord into the wall socket and switch on. The clock display will flash 12.00.

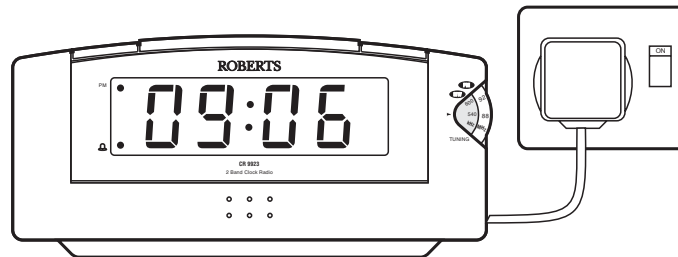

## Setting the time

1. Press and hold down the **TIME** button.

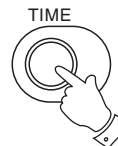

2. Whilst holding down the **TIME** button press the **Hour** or **Minute** buttons to set the time. Release the buttons when the correct time is reached. The clock uses a 12 hour display with an **PM** indicator. Ensure that the correct 12 hour cycle is selected.

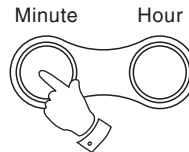

If you need any further advice, please call our Technical Helpline on :-  
020 8758 0338 (Mon-Fri)

## Listening to the Radio

1. Switch on the radio by sliding the **Function switch** to the 'On' position.

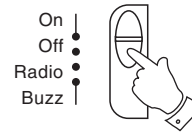

2. Select the required waveband using the **Waveband selector switch**.

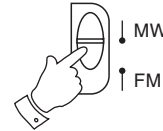

3. Tune in to the desired station by rotating the **Tuning control**.

The **Wire aerial** located on the rear of your clock radio is for FM reception. The wire should be fully extended and positioned for optimum reception.

For MW reception there is a built in ferrite aerial. Rotate the your clock radio to the position giving best reception.

4. Adjust the volume by rotating the **Volume control**.
5. The radio can be switched off by sliding the **Function switch** to the 'Off' position.

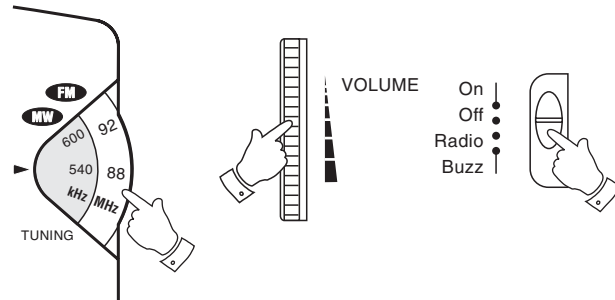

## Setting alarm time

1. Press and hold down the **ALARM/OFF button**.
2. Whilst holding down the **ALARM/OFF button** press the **Hour** or **Minute buttons** to set the time. Release the buttons when the correct alarm time is reached. The clock uses a 12 hour display with a **PM indicator**. Ensure that the correct 12 hour cycle is selected.

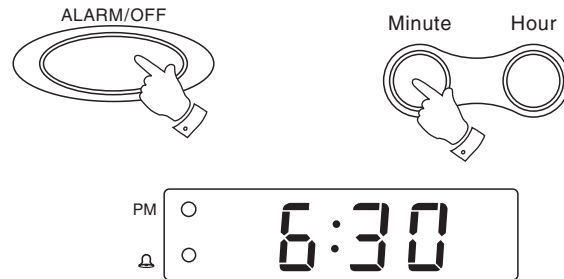

## Checking the alarm time

1. To check alarm time, press and hold down the **ALARM/OFF button** the display will show the alarm time.

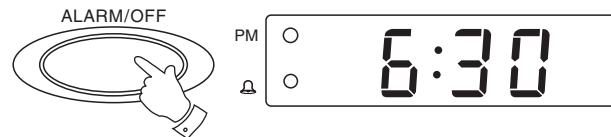

If you need any further advice, please call our Technical Helpline on :-  
020 8758 0338 (Mon-Fri)

## Setting the alarm to wake to buzzer

1. Set the alarm time as previously described. Set the **Function switch** to the 'Buzz' position. The **Alarm indicator** will light.

The alarm will sound every day at the preset time for 1 hour 59 minutes. To switch off the alarm until the next day press the **ALARM/OFF button**. To turn off the alarm permanently set the **Function switch** to the 'Off' position.

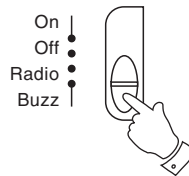

---

## Setting the alarm to wake to radio

1. Set the alarm time as previously described. Set the **Function switch** to the 'Auto' position. The **Alarm indicator** will light.

Ensure that the volume is set to the correct level and the desired station is tuned in.

The alarm will sound every day at the preset time for 1 hour 59 minutes. To turn off the alarm until the next day press the **ALARM/OFF button**. To turn off the alarm permanently set the **Function switch** to the 'Off' position.

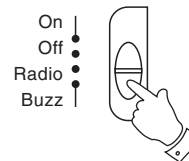



## Snooze control

1. The radio or buzzer alarm can be silenced for 9 minutes by pressing the **SNOOZE button**. This sequence can be repeated whilst the alarm is sounding.



---

## Sleep timer

The radio can be set to turn off after a preset time has elapsed.

1. Press and hold down the **SLEEP button**.
2. Whilst holding down the **SLEEP button** set the sleep time using the **Hour and Minute buttons** (maximum 1 hour and 59 minutes in 1 minute steps).

The radio will switch off after the sleep time has elapsed.

3. To cancel the sleep function before the preset time has expired, press the **SNOOZE button**.

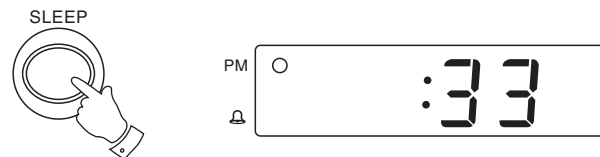

*If you need any further advice, please call our Technical Helpline on :-  
020 8758 0338 (Mon-Fri)*

## Dimmer Switch

The **DIMMER switch** located on the left side of your clock radio will allow you to adjust the intensity of the clock display to suit room brightness.

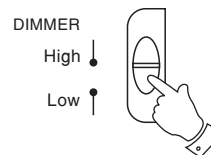

---

## Specifications

### Power Requirements

Mains : AC 230 volts, 50Hz  only  
Back-up Battery : IEC size 6LR61 (6F22, PP3)

### Frequency Coverage

FM 87.5 - 108MHz  
MW 525 - 1610kHz

## Circuit Features

Loudspeaker	8 ohms
	Output power 250mW
Aerial System	FM Wire Aerial
	MW Built-in Ferrite aerial

**ROBERTS RADIO LIMITED**  
PO BOX 130  
MEXBOROUGH  
SOUTH YORKSHIRE  
S64 8YT

*The Company reserves the right to amend the specification without notice.*

## General

Do not allow this unit to be exposed to water or steam. It is recommended that the FM band be used wherever possible as better results in terms of quality and freedom from interference will usually be obtained than on the MW band.

## Mains supply

The CR9923 will operate from a supply of AC 230volts, 50Hz  $\sim$  only. For your convenience this product is supplied with a plug which is fitted with a fuse of the appropriate rating. If the plug supplied is not suitable for your socket outlet, it should be removed by unscrewing the plug top, the terminal screws and removing the cable. The correct style of plug to suit your household together with a correctly rated fuse should be fitted.

IF IN DOUBT - CONSULT A QUALIFIED ELECTRICIAN

**IMPORTANT. DO NOT** make any connection to the larger terminal which is marked with the letter E or by the safety earth symbol  $\perp$  or coloured Green or Green-and-yellow.

The wires in the mains lead are coloured in accordance with the following codes :-

BLUE - NEUTRAL

BROWN - LIVE

As these colours may not correspond with the coloured markings identifying the terminals in your plug, proceed as follows:-

*If you need any further advice, please call our Technical Helpline on :-  
020 8758 0338 (Mon-Fri)*

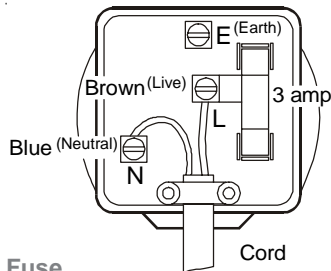

The wire coloured BLUE must be connected to the terminal marked N or coloured BLACK. The wire coloured BROWN must be connected to the terminal marked L or coloured RED.

## Fuse

This apparatus must be protected by a 3A fuse (BS1362) in a 13A plug (BS1363). If another type of plug is used a 5A fuse should be fitted in the plug, adaptor or distribution board.

IF IN DOUBT - CONSULT A QUALIFIED ELECTRICIAN.

## Back-up Battery (not necessary for the unit to function)

Slide the battery cover downwards. Remove the battery cover.

Fit a 9 volt IEC size 6LR61 (6F22, PP3) or equivalent battery into the compartment. Replace the battery cover.

The time and alarm settings will be retained during a temporary failure of the AC mains supply. The LED display will not be operational. The display will be extinguished to conserve battery life.

## Guarantee

This clock radio is guaranteed for twelve months from the date of delivery to the original owner against failure due to faulty workmanship or component breakdown, subject to the procedure stated below. Should any component or part fail during this guarantee period it will be repaired or replaced free of charge.

The guarantee does not cover:

1. Damage resulting from incorrect use.
2. Consequential damage.
3. Product with removed or defaced serial numbers.

Procedure: Any claim under this guarantee should be made through the dealer from whom the instrument was purchased. It is likely that your Roberts' dealer will be able to attend to any defect quickly and efficiently but should it be necessary the dealer will return the instrument to the company's service department for attention. In the event that it is not possible to return the instrument to the Roberts' dealer from whom it was purchased, please contact Roberts Radio service department at the address shown below before taking further action.

*These statements do not affect the statutory rights of a consumer.*

### **ROBERTS RADIO TECHNICAL SERVICES DEPARTMENT**

97-99 Worton Road  
Isleworth Middlesex  
TW7 6EG

Issue 1

Technical Helpline :- 020 8758 0338 (*Mon-Fri during office hours*)



## Free Manuals Download Website

<http://myh66.com>

<http://usermanuals.us>

<http://www.somanuals.com>

<http://www.4manuals.cc>

<http://www.manual-lib.com>

<http://www.404manual.com>

<http://www.luxmanual.com>

<http://aubethermostatmanual.com>

Golf course search by state

<http://golfingnear.com>

Email search by domain

<http://emailbydomain.com>

Auto manuals search

<http://auto.somanuals.com>

TV manuals search

<http://tv.somanuals.com>