

ROBERTS

Sound for Generations

CRD-26

DAB digital clock radio



DAB

Digital Audio Broadcasting

Please read this manual before use

Contents

<i>Controls</i>	2-3	<i>Alphanumeric station order</i>	17
<i>Using the clock radio for the first time</i>	4	<i>Active station order</i>	18
<i>Operating your clock radio</i>	5	<i>Trim stations</i>	18
<i>Selecting a station</i>	6	<i>Transfer favourites to presets</i>	18
<i>Secondary services</i>	6	<i>Dynamic range control (DRC) settings</i>	19
<i>Display modes</i>	7	<i>System reset</i>	20
<i>Finding new stations</i>	8	<i>Software version</i>	20
<i>Manual tuning</i>	9	<i>Clock display</i>	21
<i>Signal strength display</i>	9	<i>Auto dimmer</i>	21
<i>Presetting stations</i>	10	<i>Headphone socket</i>	22
<i>Recalling a preset station</i>	11	<i>Line out socket</i>	22
<i>Setting the alarm time</i>	11-13	<i>Specifications</i>	23
<i>Switch alarm on or off</i>	14	<i>Circuit features</i>	23
<i>To view alarm/s time</i>	14	<i>General</i>	24
<i>Cancelling alarms</i>	15	<i>Notes</i>	25
<i>Snooze function</i>	15	<i>Guarantee</i>	26
<i>To set snooze time</i>	15		
<i>Sleep function</i>	16		
<i>Station order</i>	17		
<i>Favourite station order</i>	17		

Controls (Top)

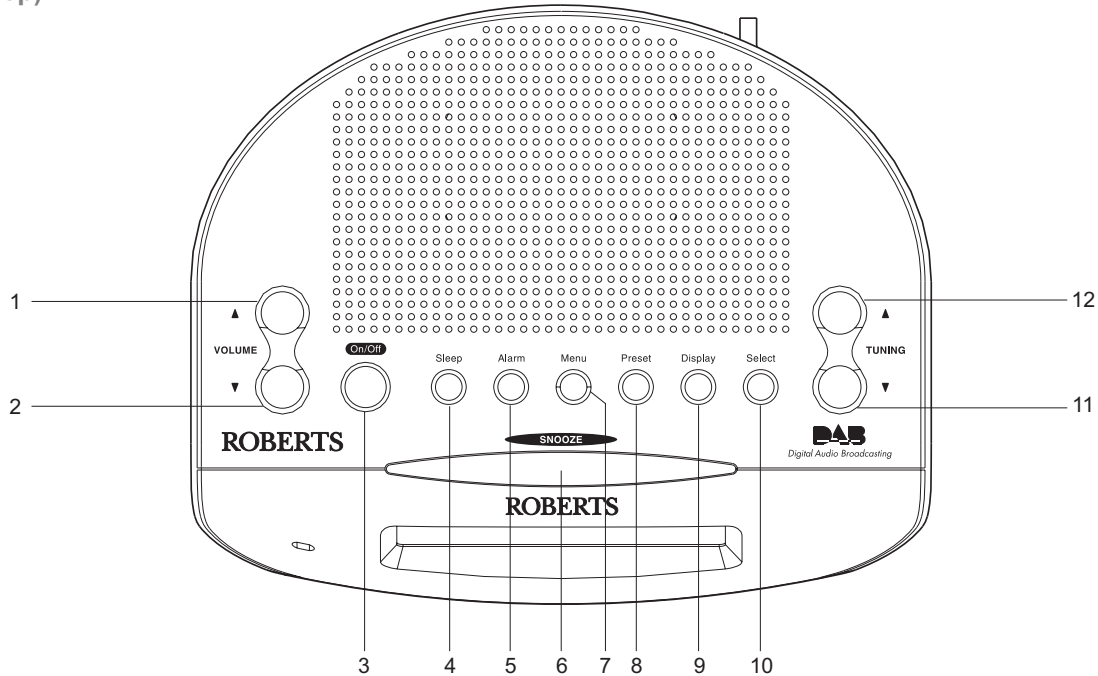

1. Volume Up button
2. Volume Down button
3. On/off button
4. Sleep button

5. Alarm button
6. Snooze button
7. Menu button
8. Preset button

9. Display button
10. Select button
11. Tuning Down button
12. Tuning Up button

Controls (Front)

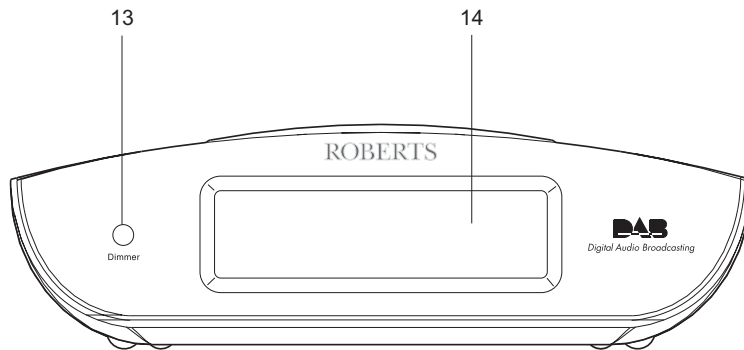

13. Auto Dimmer

14. LCD display

Controls (Rear)

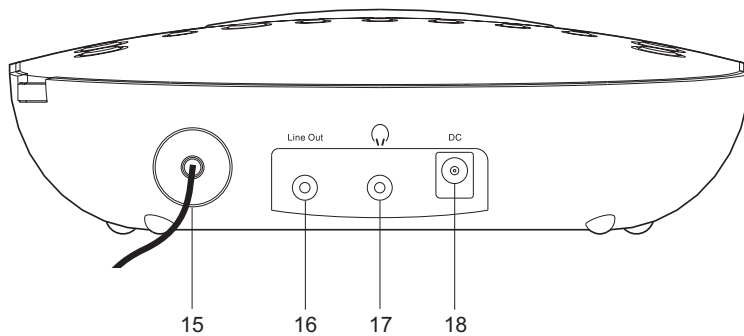

15. DAB wire aerial

16. Line out socket

17. Headphone socket

18. DC jack socket

Using the clock radio for the first time

Your clock radio is supplied with a Mains Adaptor.

1. Place your clock radio on a flat surface.
2. Insert the adaptor plug into the DC socket located on the rear of your clock radio.
3. Fully extend the wire aerial located on the rear of your clock radio. The wire should be fully extended and positioned for optimum reception.
4. Plug the adaptor into a standard 13 amp mains socket outlet.
5. When your clock radio is first switched on the display will show "Setting Clock..." and a station search will be performed automatically.
6. When stations have been found, the clock information will appear on the display. When the unit is in standby mode you can press the display button to toggle between showing the time only or showing both the date and time.
7. If no stations have been found "clock not set..." will be displayed. It may then be necessary to relocate your clock radio to a position giving better reception. You should then carry out an autoscans to find stations as described on page 8.

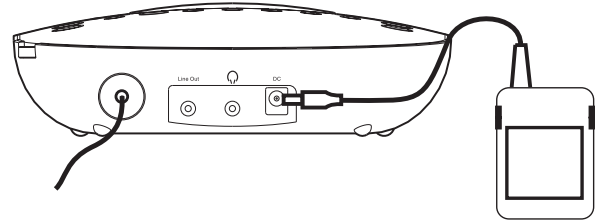

Setting Clock...

12:30

Operating your clock radio

1. Press the **On/off button** to switch on your clock radio. The display will show "Now tuning" for a few seconds.
2. If the clock radio has been used before, the last used station will be selected.
3. The first station in the list of stations found will be played. The display will show the station name in the first line of the display and other information in the second line.
4. If no signals are found "No stations available" will be displayed and it may be necessary to relocate your clock radio to a position giving better reception. You should then carry out an autoscans to find stations as described on page 8.



Now tuning...

1Xtra
BBC National

No stations
available

Selecting a station

1. The top line of the display shows the name of the station currently selected.
2. Press the **Tuning up or down buttons** to step through the list of available stations.
3. Press and release the **Select button** to select the station. The display may show "Now tuning" while your radio finds the new station.
4. Adjust the **Volume control** to the required setting.

Note: If after selecting a station the display shows "Not Available" it may be necessary to relocate your radio to a position giving better reception.

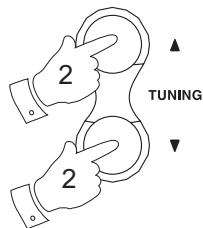

Select



Classic

BBC 7
*1Xtra *

Now tuning...

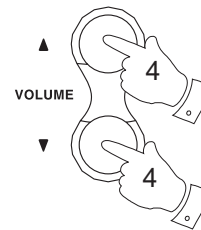

Secondary services

1. Certain radio stations have one or more secondary services associated with them. If a station has a secondary service associated with it the display will show ">>" next to the station name on the station list. The secondary service will then appear immediately after the primary service as you move through the tuning list.
2. Press and release the **Select button** to select the station.

Select



BBC Radio 5
* BBC 5 Live >> *

BBC Radio 5
* << BBC SertX *

Display modes

Your radio has seven display modes:-

1. Press the **Display button** to cycle through the various modes.



- a. Scrolling text Displays scrolling text messages such as artist/track name, phone in number, etc.

- b. Programme type Displays type of station being listened to e.g. Pop, Classic, News, etc.

- c. Multiplex Name Displays name of multiplex to which current station belongs.

- d. Time and date Displays current time and date.

- e. Channel and frequency Displays channel number and frequency.

- f. Bit rate and audio type Displays the digital bit rate and audio mode.

- g. Signal strength Displays the signal strength for station being listened to.

a
BBC 7
Just a Minute...

b
BBC 7
Culture

c
BBC 7
BBC National

d
BBC 7
19:17 08-06-2005

e
BBC 7
11C 220.35 MHz

f
BBC 7
128kbps Stereo

g
BBC 7
Sig strength 100

Finding new stations

As time passes new stations may become available. To find new stations proceed as follows:-

1. Press and release the **Menu button** and press the **Tuning up or down buttons** until "Autoscan UK" shows on the display.
2. Press and release the **Select button**. Your radio will perform a scan of the UK DAB frequencies. As new stations are found the station counter on the right-hand side of the display will increase and stations will be added to the list
3. To carry out a full scan of the entire DAB Band III frequencies press and release the **Menu button** and press the **Tuning up or down buttons** until the display shows "Autoscan full".
4. Press and release the **Select button**. As new stations are found the station counter on the right-hand side of the display will increase and stations will be added to the list.

Menu

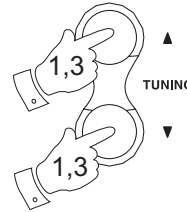

Select



Menu



Select



Manual Tuning

Manual tuning allows you to tune and add the various DAB Band III channels to your station list. UK DAB stations located in the range 11B to 12D. This function can be used to assist the positioning of the antenna or your clock radio to obtain the optimum reception for a specific channel / frequency.

1. Press the **Menu button** the display will show "Alarm settings".
2. Press the **Tuning up or down buttons** until the display shows "Manual tune".
3. Press and release the **Select button**.
4. Press the **Tuning up or down buttons** to select the required DAB channel.
5. Press and release the **Select button** the open bar in the middle shows you the minimum signal strength needed for good DAB reception. The signal strength bars will go up and down showing the changing signal strength as you adjust the wire aerial or your clock radio position.
6. Press the **Select button** to return to normal service.

Menu



◆ ◆ or SELECT
◆ Alarm settings ◆

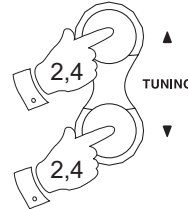

◆ ◆ or SELECT
◆ Manual tune ◆

◆ 11C 220.35 MHz ◆

Select



■■■■■
11C EMAP SY

Signal strength display

1. Press and release the **Select button** the display will show signal strength. Press the **Select button** to exit signal strength display.
2. Position your clock radio and fully extend the wire aerial for best reception using the signal strength display as a guide. Move your clock radio around and position so as to give maximum number of black rectangles on signal strength display. The clear unfilled rectangle indicates minimum signal level required for satisfactory reception.

Select



BBC 7
■■■■■

Presetting stations

There are 10 memory presets available.

1. Press the **On/off button** to switch on the clock radio.
2. Tune to the required station as previously described.
3. Press the **Preset button**, the display will show "Empty preset 1" if there are no presets stored.
4. Use the **Tuning up or down buttons** to select the desired preset number under which you wish to store the station.
5. Press and hold down the **Preset button** until the display shows e.g. "Preset 1 saved". The station will be stored under the chosen preset button. Repeat this procedure for the remaining presets.
6. Stations stored in preset memories may be overwritten by following the above procedure.

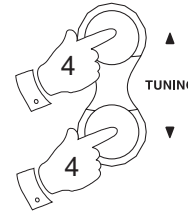

BBC R2
◆ Empty Preset 1 ◆

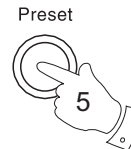

BBC R2
Preset 1 saved

Recalling a preset station

1. Press the **On/off button** to switch on the radio.
2. Press the **Preset** button.
3. Use the **Tuning up or down buttons** to select the desired preset number and press the **Select button**. Your clock radio will tune to the station stored in the preset memory.

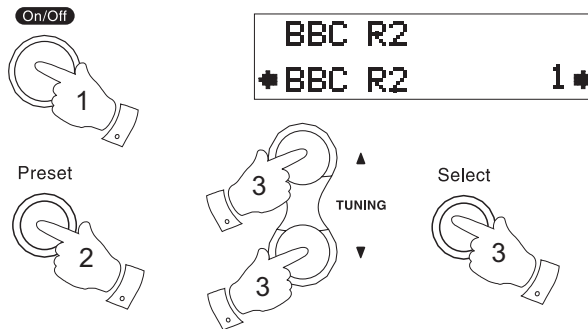

Setting the alarm time

Your clock radio has four separate alarms which can be set to wake you to either radio or beep type alarm. Each alarm can be set to sound once, daily, weekdays and weekends. The alarms can be set with the radio in the on or the off position. In the event of a power interruption your clock radio has a built in memory chip that will maintain all your alarm settings when the power is restored.

Note: If no buttons are pressed for 5 seconds the clock radio will exit the alarm setup.

To exit the alarm menu at any time press the **Menu button**.

1. Press the **On/off button** to switch on your clock radio.
2. Press the **Alarm button** and "Set alarm" will appear on the display.
3. Press the **Select button** to enter the alarm setup. If there are no alarms set the display will show "Alarm not in use".

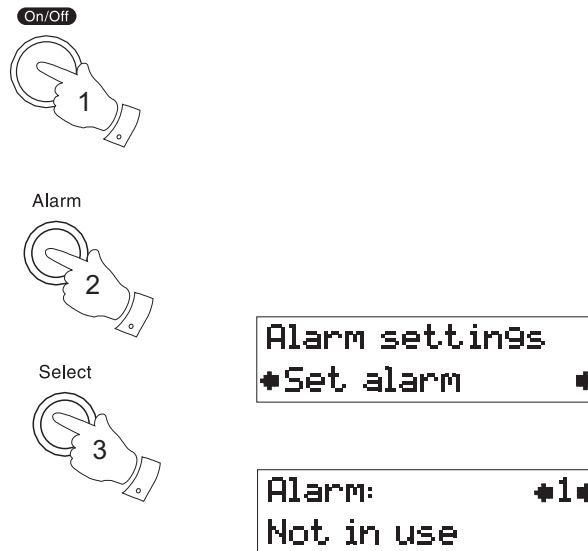

4. Press the **Tuning up or down buttons** to select the desired alarm 1-4.

5. Press the **Select button** to enter the alarm hour. The display will show the current time in 24 hour format. The hour digit will be selected.

Note: Alarm times are set using 24Hr format e.g. 2:30PM is entered as 14:30

6. Press the **Tuning up or down buttons** to set the correct hour.

7. Press the **Select button** to enter the alarm minutes. The minute digit will be selected.

8. Press the **Tuning up or down buttons** to set the correct minutes.

9. Press the **Select button** to enter the alarm day option. Your alarm can be set to sound once, daily, weekdays and weekends.

Once - Will sound at one time only.

Daily - Will sound every day.

Weekdays - Will sound only on weekdays.

Weekends - Will sound only on weekends.

10. Press the **Tuning up or down buttons** to select either once, daily, weekdays or weekends.

• **If setting alarms to daily, weekdays or weekends proceed to point 18 (Setting alarm mode).**

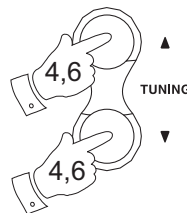

Alarm: *1*
Not in use

* * or SELECT
Time *07*:00

Select



* * or SELECT
Time 07:*30*

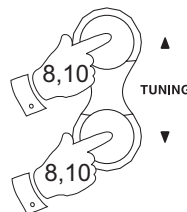

Select



Set alarm date
Once

11. If selecting the alarm to once you will need to set the year, month and day options as described below.

12. Press the **Select button** to enter the alarm year option.

13. Press the **Tuning up or down buttons** to select the correct year.

14. Press the **Select button** to enter the alarm month option.

15. Press the **Tuning up or down buttons** to select the correct month.

16. Press the **Select button** to enter the alarm day.

17. Press the **Tuning up or down buttons** to select the correct day.

18. Press the **Select button** to enter the alarm mode, the alarm mode can be set to either DAB (Radio) or BUZZER.

19. Press the **Tuning up or down buttons** to select either DAB or BUZZER alarm mode option.

20. Press the **Select button** to confirm alarm settings. The display will show the alarm settings.

21. Press the **Menu button** to exit the menu options.

Note: The alarm/s will not sound if the alarms have not been activated and set to the On position. (see page 14)

When the alarm is set to wake by radio your clock radio will switch on to the last used station. When alarm activates, volume will start from minimum and increase in level every 2-3 seconds.

Select



Set alarm date
◆Once◆

◆ ◆ or SELECT
Year ◆2005◆

◆ ◆ or SELECT
Month ◆11◆

◆ ◆ or SELECT
Day ◆20◆

Alarm To
◆DAB◆

Alarm To
◆Buzzer◆

Select

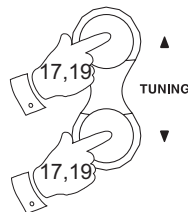

Select



Alarm: ◆1◆
07:30 08-06-05◆

Switching alarm/s on or off

1. To activate the alarm/s press the **Alarm button** and enter the alarm setup menu. The display will show "Set alarm".
2. Press the **Tuning up or down buttons** until "alarm On/off" shows on the display.
3. Press and release the **Select button**. The alarm settings will be displayed.
4. Press the **Tuning up or down buttons** until the required alarm is reached 1-4.
5. Press the **Select button** to switch the required alarm on. The display will show a bell symbol when the alarm is set to on.
6. To switch off the alarm permanently, press the **Select button** to switch the required alarm off. The bell symbol will disappear from the display.
7. Press the **Menu button** to exit the alarm setup. The alarm/s will sound at the selected times. The alarm will sound for 90 minutes unless cancelled.

Alarm



```
Alarm settings
*Set alarm *
```

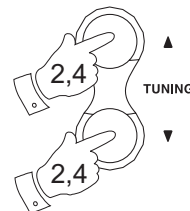

```
Alarm settings
*Alarm on/off *
```

Select



```
Alarm: *1*
07:30 Once
```

```
Alarm: *1*
07:30 Once *
```

Menu



```
Alarm: *1*
07:30 Once
```

To view alarm time

1. Press the **Alarm button** to enter the alarm setup.
2. Press the **Select button** then press the **Tuning up or down buttons** to view alarms 1-4.

Alarm



Select



```
Alarm: *1*
07:30 08-06-05 *
```

Cancelling alarms

Whilst an alarm is sounding it can be cancelled for 24 hours by pressing the **Alarm button**.

Alarm



Snooze function

When the radio or beep alarm sounds, pressing the Snooze button will silence the alarm for the selected number of minutes. The Snooze setting can be adjusted between 5 and 20 minutes in 5 minute increments.

The radio or buzzer alarms can be silenced for a set time by pressing the **Snooze button**.

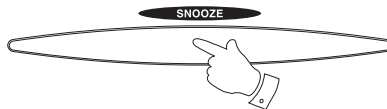

To set snooze time

1. To set the snooze to the desired snooze time, press the **Menu button** to enter the menu setup.
2. Press the **Tuning up or down buttons** until "alarm settings" appear on display. Press the **Select button**.
3. Press the **Tuning up or down buttons** until "Snooze" appears on the display. Press and release the **Select button**.
4. Press the **Tuning up or down buttons** to select the desired snooze setting 20>15>10>5 minutes.
5. Press the **Select button** to select desired time. The radio will exit the menu options and return to radio play mode.

Menu

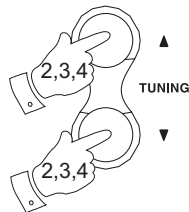

Select



Alarm settings
◆ Set alarm ◆

Alarm settings
◆ Snooze ◆

Snooze
◆ 5 minutes ◆

Snooze
◆ 20 minutes ◆

Sleep function

Your clock radio can be set to turn off after a preset time has elapsed. The sleep setting can be adjusted between 5 and 90 minutes in 5 minute increments.

1. To set the sleep to the desired sleep time, press the **Sleep button** to enter the sleep setup. "Sleep" will appear on the display.
2. Press the **Tuning up or down buttons** to select desired sleep time 90>85>80>75>70>65>60>55>50>45>40>35>30>25>20>15>10>5 minutes or to OFF to permanently cancel the sleep function.
3. Press the **Select button**. The display will show "Sleep activated" and then exit the sleep options.
4. Your radio will switch off after the preset sleep time has elapsed.
5. To cancel the sleep function before the preset time has elapsed, press the **On/off button**.

Sleep



Sleep
*Off

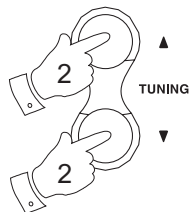

Sleep
*5 minutes

Select



Sleep
*60 minutes

On/Off



Sleep Activated
*60 minutes

Station order

This function enables you to choose how the stations are arranged when selecting a station. There are 5 options available favourite station, alphanumeric, active stations, trim stations and preset stations.

Note: Your clock radio default station order is numeric-alpha order.

1. Press the **On/off button** to switch on your clock radio.
2. Press the **Menu button** to enter the menu setup.
3. Press the **Tuning up or down buttons** until "Station order" appears on the display. Press the **Select button**.
4. Press the **Tuning up or down buttons** to choose between favourite station, alphanumeric, active stations, trim stations or presets. Press and release the **Select button** to select desired station order.

Favourite station

When this setting is switched on, after a period of time the most listened to stations will move to the top of the station list and will be marked with the heart symbol ♥. Your ten favourite stations will be displayed.

Alphanumeric

When this setting is switched on your clock radio will now select stations in alphanumeric order 0...9 A...Z.

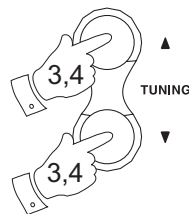

◆ ◆ or SELECT
◆ Station order ◆

◆ Fav station ◆

◆ Alphanumeric ◆

Active station

When this setting is switched on the display will show only those that a signal can be found for.



Trim stations

Some DAB services may stop broadcasting or you may not be able to receive a station. Trim stations will delete the DAB stations from your station list that can no longer be received.

When this setting is switched on your clock radio will delete the stations that are not currently being received.



Transfer favourites to presets

This option is only available when favourites has been previously selected on the station order.

When this setting is switched on your favourite stations will be transferred to the preset station memories.

Note: This will overwrite any stations already stored in presets.



Dynamic Range Control (DRC) settings

DRC can make quieter sounds easier to hear when your radio is used in a noisy environment.

1. Press the **On/Off button** to switch on your clock radio.
2. Press the **Menu button** to enter the menu setup.
3. Press the **Tuning up or down buttons** until "DRC value" appears on the display. Press the **Select button**. The display will show the current DRC value on the top line.
4. Press the **Tuning up or down buttons** to select the required DRC setting. Default is 0.
 - DRC 0 DRC is switched off, Broadcast DRC will be ignored.
 - DRC 1/2 DRC level is set to 1/2 that sent by broadcaster.
 - DRC 1 DRC is set as sent by broadcaster.
5. Press and release the **Select button** to confirm the setting. The display will return to radio mode.

On/Off



Menu

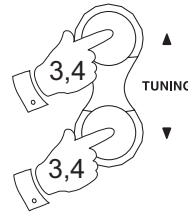
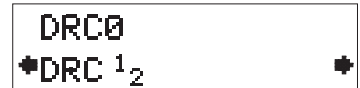

Select



System reset

If your radio fails to operate correctly, or some digits on the display are missing or incomplete carry out the following procedure.

1. Press and hold in the **Menu button** until the display shows "Press SELECT to confirm reset..."
2. Press in and release the **Select button** to select System reset.
3. A full reset will be performed and the station list together with any preset stations will be erased.

If a problem persists our technical staff would be pleased to help offer any assistance on operating the clock radio. Our technical helpline number is 020 8758 0338.

Menu



Press SELECT to
confirm reset...

Select



Roberts
■■■■■

Now tuning...

1Xtra
BBC National

Software version

The software display cannot be altered and is just for your reference

1. To view which software version your clock radio has press the **Menu button** to enter the menu setup.
2. Press the **Tuning up or down buttons** until "SW Version" appears on the display. The Version number is displayed on the top line.

Menu

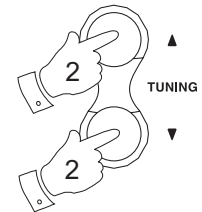

◆ U1.31.1.9-2
◆ Sw Version ◆

Clock display

When in Standby your clock radio has two display modes, time or time and date combined.

1. If your clock radio is switched on, press the **On/off button** to switch your clock radio to the standby mode.
2. To toggle between the two display modes press the **Display button**.

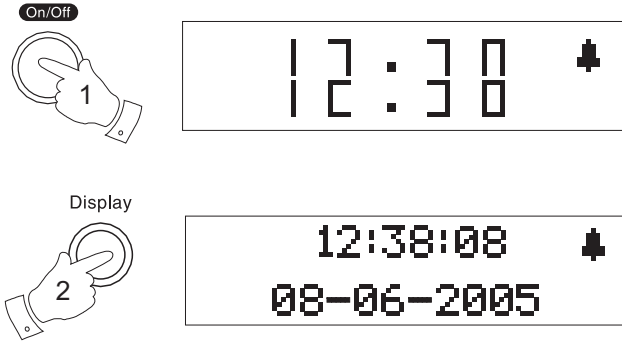

Auto dimmer

The auto dimmer located on the front of your clock radio will automatically adapt the intensity of the display to suit the ambient room lighting.

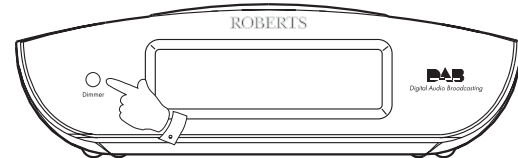

Headphone socket

A 3.5mm **Headphone Socket** located on the rear of your clock radio is provided for use with either headphones or an earpiece. Inserting a plug automatically mutes the internal loudspeaker.

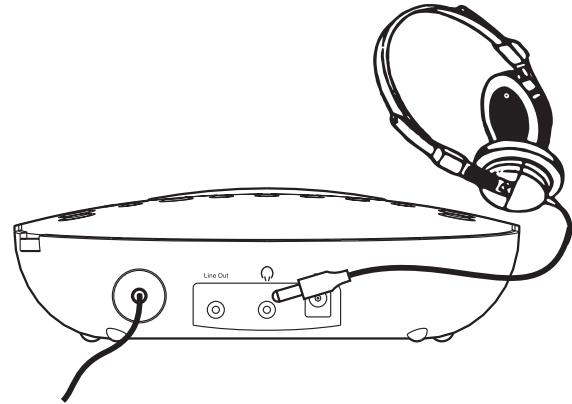

Line out socket

A 3.5mm **Line out socket** located on the rear of your clock radio is provided for connecting the audio signal to an external amplifier. Inserting a plug into the line output socket will mute the internal loudspeaker. Set the volume control to adjust the line out volume level.

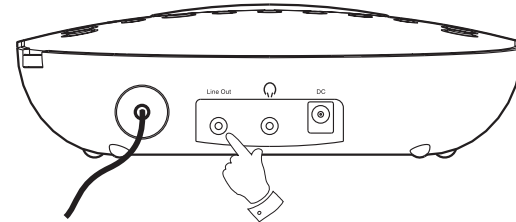

Specifications

Power Requirements

AC Adaptor AC 230 volts, 50Hz  only

Frequency Coverage

DAB 174.928 - 239.200MHz

Circuit Features

Loudspeaker 1 x 66mm

Output Power 1W into 8 ohms

Headphone socket 3.5mm dia

Line out socket 3.5mm dia

Aerial System DAB Wire aerial

The Company reserves the right to amend the specification without notice.

General

Do not allow this clock radio to be exposed to water, steam or sand. Do not leave your radio where excessive heat could cause damage such as in a parked car where the heat from the sun can build up even though the outside temperature may not seem too high.

- The name plate is located on the bottom of the unit.

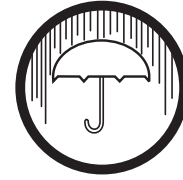
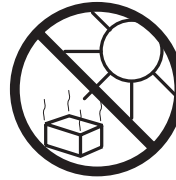

Notes

Guarantee

This instrument is guaranteed for twelve months from the date of delivery to the original owner against failure due to faulty workmanship or component breakdown, subject to the procedure stated below. Should any component or part fail during this guarantee period it will be repaired or replaced free of charge.

The guarantee does not cover:

1. Damage resulting from incorrect use.
2. Consequential damage.
3. Receivers with removed or defaced serial numbers.

Procedure:

Any claim under this guarantee should be made through the dealer from whom the instrument was purchased. It is likely that your Roberts' dealer will be able to attend to any defect quickly and efficiently but should it be necessary the dealer will return the instrument to the Company's service department for attention. In the event that it is not possible to return the instrument to the Roberts' dealer from whom it was purchased, please contact Roberts Radio Technical Services at the address shown on the rear of this manual.

These statements do not affect the statutory rights of a consumer.



Issue 1

ROBERTS RADIO TECHNICAL SERVICES

97-99 Worton Road

Isleworth Middlesex

TW7 6EG

Technical Helpline :- 020 8758 0338 (*Mon-Fri during office hours*)

Website: <http://www.robertsradio.co.uk>



Free Manuals Download Website

<http://myh66.com>

<http://usermanuals.us>

<http://www.somanuals.com>

<http://www.4manuals.cc>

<http://www.manual-lib.com>

<http://www.404manual.com>

<http://www.luxmanual.com>

<http://aubethermostatmanual.com>

Golf course search by state

<http://golfingnear.com>

Email search by domain

<http://emailbydomain.com>

Auto manuals search

<http://auto.somanuals.com>

TV manuals search

<http://tv.somanuals.com>