

ROBERTS

Sound for Generations

CRD-29

FM RDS/DAB digital radio with Dual Alarms, Sleep timer and Nap timer

Gemini 29
CRD-29



DAB

Digital Audio Broadcasting

Please read this manual before use

Contents

<i>Controls</i>	2-3	<i>Nap timer</i>	17
<i>Mains operation</i>	4	<i>Sleep timer</i>	18
<i>Operating your radio - DAB</i>	5	<i>Headphone socket</i>	19
<i>Selecting a station - DAB</i>	6	<i>Display backlight</i>	19
<i>Secondary services - DAB</i>	7	<i>Auxiliary in socket</i>	19
<i>Display modes - DAB</i>	7	<i>Headphone socket</i>	20
<i>Finding new stations - DAB</i>	8	<i>Specifications</i>	20
<i>Autoselect - DAB</i>	8	<i>Circuit features</i>	20
<i>Manual tuning - DAB</i>	9	<i>General</i>	21
<i>Signal strength display - DAB</i>	9	<i>Mains Supply</i>	21
<i>Operating your radio - FM</i>	10	<i>Guarantee</i>	22
<i>Manual tuning - FM</i>	11		
<i>Display modes - FM</i>	12		
<i>FM stereo/mono</i>	12		
<i>Presetting stations - DAB and FM</i>	13		
<i>Recalling a preset station - DAB and FM</i>	13		
<i>System reset</i>	14		
<i>Setting the alarm time</i>	15-16		
<i>To view alarm time</i>	16		
<i>Cancelling alarms</i>	16		
<i>Snooze function</i>	17		

Controls (Front)

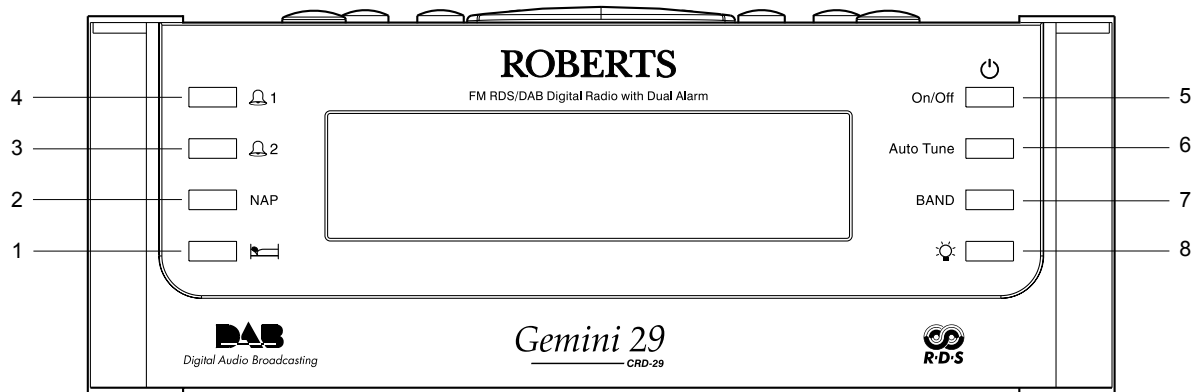

1. Sleep button
2. Nap timer button
3. Alarm 2 button
4. Alarm 1 button

5. On / Off button
6. Auto-tune button
7. Waveband button
8. Light button

Controls (Top)

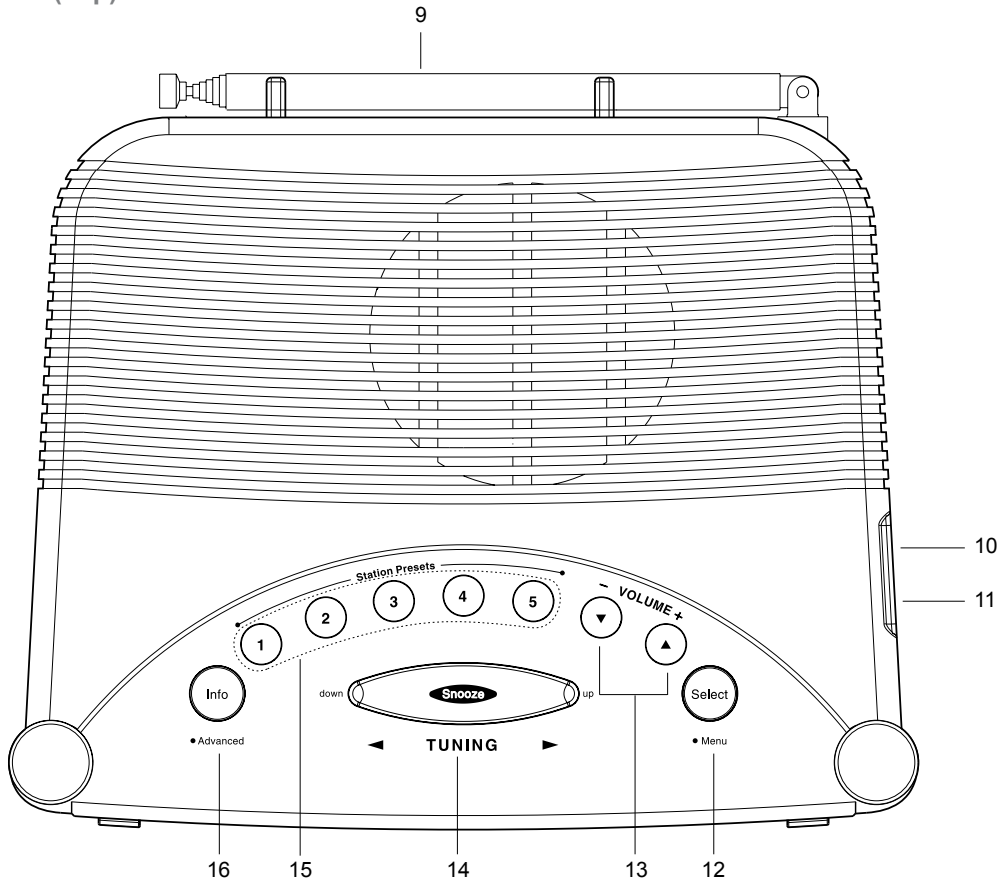

- 9. Telescopic aerial
- 10. Headphone socket
- 11. Auxiliary In socket
- 12. Menu / Select button
- 13. Volume up / down buttons
- 14. Tuning / Snooze button
- 15. Preset buttons
- 16. Info button

Mains operation

1. Place the unit on a flat surface. Plug the mains lead into a wall socket and switch on the wall socket.
2. The display will show "Clock Setting..." for a few seconds before returning to clock display.
3. The clock radio will attempt to set the clock from a DAB signal. If a signal is found then the time will be displayed. If no suitable signal is found, the radio will display "Clock N/A" and will then display a time of 00:00. If this happens it is not a fault. The time should be set once a DAB signal is being received, see page 5.

Please note the time must be set before the alarm function can be used.

- The mains plug is used to connect your apparatus to the AC mains supply. In order to completely disconnect the apparatus from the AC mains supply, the mains plug should be removed from the mains socket outlet.

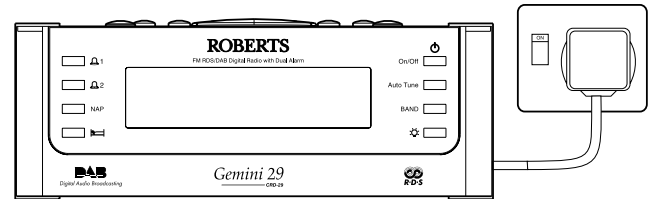

Clock setting ...

Operating your radio - DAB

1. Fully extend the telescopic aerial.
2. Press the **On/Off button** to switch on your radio.
3. If this is the first time the radio is used press the **Auto-tune button** to perform a quick scan of UK Band III DAB channels. The display will show "Autotune Quick scan". If the radio has been used before the last used station will be selected.
4. During Autotune as each group of stations is detected the bottom line of the display will show its name and the station count will be updated. The top line of the display shows a bargraph indicating progress of the Autotune.
5. When the Auto tune is complete the first station (in numeric-alpha order 0...9...A....Z) will be selected.
6. If the station list is still empty after the Autotune your radio will display "No Signal".
7. If no signals are found it may be necessary to relocate your radio or the antenna to a position giving better reception.

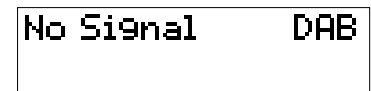
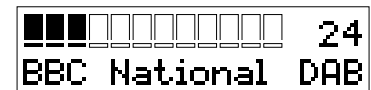
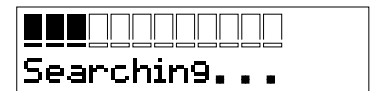
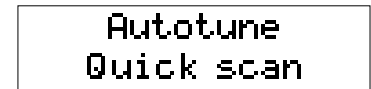
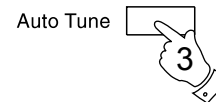
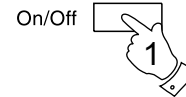
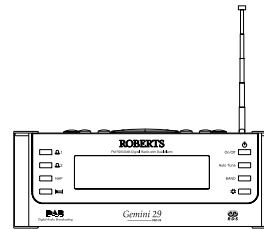

Selecting a station - DAB

1. The top line of the display shows the name of the station currently selected.
2. Press the **Tuning up or down buttons** to step through the list of available stations.
3. Press and release the **Menu/Select button** to select the station. The display may show "Tuning" while your radio finds the new station.
4. Adjust the **Volume control** to the required setting.

Note: If after selecting a station the display shows "Not Available" it may be necessary to relocate your radio or the antenna to a position giving better reception.

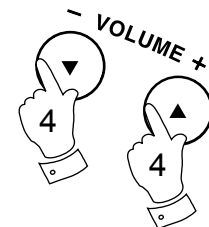
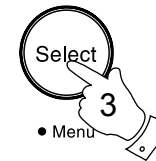
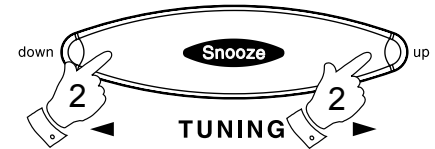

Secondary services - DAB

1. Certain radio stations have one or more secondary services associated with them. If a station has a secondary service associated with it the display will show ">" next to the station name on the station list. The secondary service will then appear immediately after the primary service as you move through the tuning list.

BBC 5 Live> DAB

BBC SportX> DAB

Display modes - DAB

Your radio has six display modes:-

1. Press the **Info button** to cycle through the various modes.

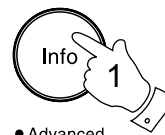

• Advanced

- | | |
|--------------------|---|
| a. Scrolling text | Displays scrolling text messages such as artist/track name, phone in number, etc. |
| b. Programme type | Displays type of station being listened to e.g. Pop, Classic, News, etc. |
| c. Multiplex Name | Displays name of multiplex to which current station belongs. |
| d. Signal strength | Displays signal strength for station being listened to. |
| e. Time and date | Displays current time and date. |
| f. Audio type | Displays audio type and bit rate |

a BBC 7 DAB
 Just a Minute...

b BBC 7 DAB
 Culture

c BBC 7 DAB
 BBC National DAB

d BBC 7 DAB



e BBC 7 DAB
 19:17 08-06-2005

f BBC 7 DAB
 Mono 30 kbps

Finding new stations - DAB

As time passes new stations may become available. To find new stations proceed as follows:-

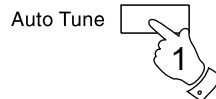
1. Press and release the **Auto-tune button**, the display will show "Auto-tune Quick Scan". Your radio will perform a scan of the UK DAB frequencies. As new stations are found the station counter on the right-hand side of the display will increase and stations will be added to the list
2. To carry out a full scan of the entire DAB Band III frequencies press and hold down the **Aut-tune button** for more than 2 seconds and then release. The display will show "Autotune Full scan". As new stations are found the station counter on the right-hand side of the display will increase and stations will be added to the list



Autotune
Quick scan

 24
BBC National DAB

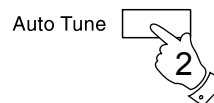

Autotune
Full scan...

Autoselect - DAB

As an alternative to pressing the Menu/Select button to select a station your radio can be set so as to automatically select a station.

1. Press and hold in the **Menu/Select button** until the display shows "Autoselect ON".
2. Scroll through the tuning list using the **Tuning up or down buttons** until the station you require is visible on the display, after a few seconds your radio will automatically select the station shown on the display.
3. To switch off Autoselect press and hold in the **Menu/Select button** until the display shows "Autoselect OFF".

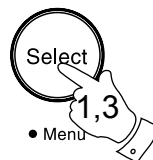

Autoselect ON

BBC 7 DAB
BBC National DAB

Autoselect OFF

Manual Tuning - DAB

Manual tuning allows you to tune directly to the various DAB Band III channels. UK DAB stations located in the range 11B to 12D.

1. Press and hold in the **Info button** until the display shows "Manual tune". Press and release the **Menu/Select button**.
2. Press the **Tuning up or down buttons** to find the required DAB channel.
3. Press and release the **Menu/Select button** to select the channel.
4. Press the **Tuning up or down buttons** to select the stations contained within the Multiplex for the selected DAB channel.
5. Press and release the **Menu/Select button** to return to normal tuning mode.

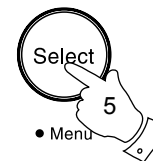
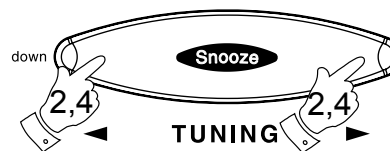
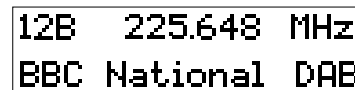
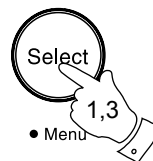
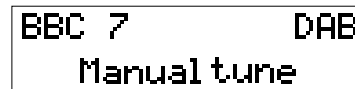

Signal strength display - DAB

1. Repeatedly press and release the **Info button** until the lower line of the display shows signal strength.
2. Position your radio and angle the telescopic aerial for best reception using the signal strength display as a guide. Move your radio around and position so as to give maximum number of black rectangles on signal strength display. The clear unfilled rectangle indicates minimum signal level required for satisfactory reception.

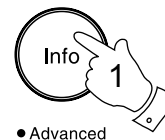

Operating your radio - FM

1. Fully extend the telescopic aerial.
2. Press the **On/Off button** to switch on your radio. If in DAB mode, the radio will tune to the previous DAB station.
3. Press the **Band button** to select the FM band.
4. Press and immediately release the **Auto-tune button**, your radio will scan in an upwards direction (low frequency to high frequency) and stop automatically when it finds a station of sufficient strength.
5. If RDS information is available after a few seconds the display will update and show station name.
6. To find other stations press and release the **Auto-tune button** as before.
7. To scan the FM band in a downwards direction (high frequency to low frequency) press and hold down the **Auto-tune button** until the display shows the radio frequency changing.
8. When the waveband end is reached your radio will recommence tuning from the opposite waveband end.
9. Adjust the **Volume control** to the required settings.
10. To switch off your radio press the **On/Off button**.

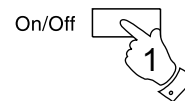
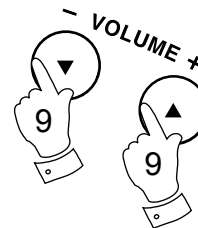
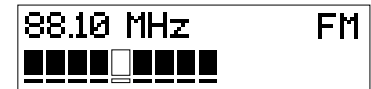
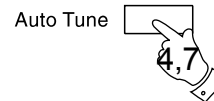
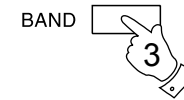
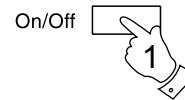

Manual tuning - FM

1. Press the **On/Off button** to switch on your radio.
2. Press the **Band button** to select the FM band. Fully extend the Telescopic aerial.
3. Press the **Tuning up or down buttons** to tune to a station. The frequency will change in steps of 50kHz.
4. When the waveband end is reached the radio will recommence tuning from the opposite waveband end.
5. Set the **Volume control** to the desired setting.
6. To switch off your radio press the **On/Off button**.

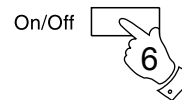
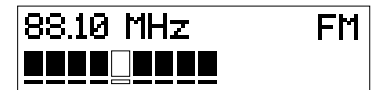
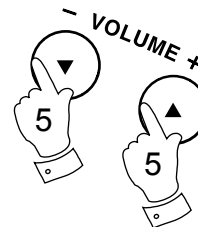
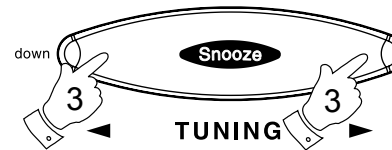
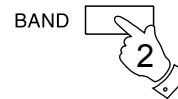
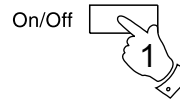

Display modes - FM

On FM the bottom line of the display can be set to any of the following modes:-

1. Press the **Info button** to cycle through the various modes.

- | | |
|--------------------|--|
| a. Scrolling text | Displays scrolling text messages such as artist/track name, phone in number etc. |
| b. Program Type | Displays type of station being listened to e.g. Pop, Classic, News, etc. |
| c. Signal strength | Displays signal strength for station being listened to. |
| d. Time and date | Displays current time and date. |
| e. Frequency | Displays frequency of the station being listened to. |
| f. Audio mode | Display shows Auto (stereo) or mono. |

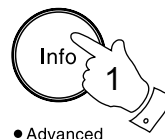

• Advanced

- | | |
|---|-------------------------------|
| a | BBC R2 FM
The latest news |
| b | BBC R2 FM
Pop Music |
| c | BBC2 FM
■■■■■□■■■■■ |
| d | BBC R2 FM
12:02 16-06-2003 |
| e | BBC2 FM
88.10 MHz |
| f | BBC R2 FM
Auto (Stereo) |

FM Stereo/Mono

1. If a station being received is weak some hiss may be audible. To reduce the hiss press and release the **Menu/Select button** until the display shows "Audio mode : mono" your radio will switch to mono mode.
2. To return to stereo mode press and release the **Menu/Select button** until the display shows "Audio mode :Auto", your radio will switch to stereo mode.

Note: FM stereo is only available when using earphone/head-phones

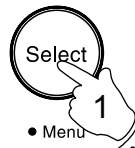

• Menu

Audio mode: Mono

Audio mode: Auto

Presetting stations - DAB and FM

There are 5 memory presets for each of the 2 wavebands.

1. Press the **On/Off button** to switch on the radio.
2. Tune to the required station as previously described.
3. Press and hold down the required **Preset button** until the display shows e.g. "Preset 1 stored". The station will be stored under the chosen preset button. Repeat this procedure for the remaining presets.
4. Stations stored in preset memories may be overwritten by following the above procedure.

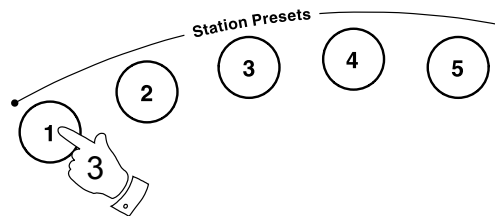
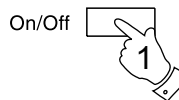

BBC R2	DAB
Preset 1 stored	

Recalling a preset station - DAB and FM

1. Press the **On/Off button** to switch on the radio.
2. Select the required waveband by pressing the **Band** button.
3. Momentarily press the required **Preset button**, your radio will tune to the station stored in preset memory.

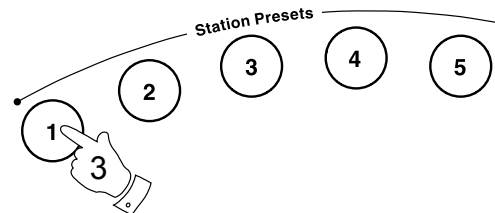
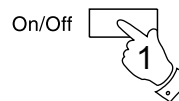

BBC 7	DAB
BEC National	DAB

System reset

If your radio fails to operate correctly, or some digits on the display are missing or incomplete carry out the following procedure.

1. If in DAB mode, press and hold **Info button** until the display shows "Manual Tune".
 2. Press and release the **Info button** until the display shows "System reset" then immediately press **Menu/Select button**.
 3. If in FM mode, press and hold **Info button** until display shows "System reset", then immediately press **Menu/Select button**.
 4. If DAB was used last then a "Quick scan" of the DAB band will be performed, otherwise a "Quick scan" will be carried out the next time the DAB band is selected.
- Note: System reset clears all presets, clears the DAB station list, clears all timers and resets volume to the default setting.

If a problem persists our technical staff would be pleased to help offer any assistance on operating the radio. Our technical helpline number is 020 8758 0338.

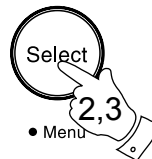

BBC 7 DAB
Manualtune

BBC 7 DAB
System Reset

Autotune
Quick scan

■■■■■■■■■■■■■■■■■■■■
Searching...

■■■■■■■■■■■■■■■■■■■■ 24
BBC National DAB

Setting the alarm time

There are two alarm timers which are individually controlled and may independently be set to Buzzer, Radio or Off.

Note: Alarm times are set using 24Hr format e.g. 2:30PM is entered as 14:30

1. Press and hold the required alarm button, **alarm 1** or **alarm 2**.
2. To change the alarm state press the **Tuning up or down buttons**. Your alarm can be set to wake you by Buzzer or Radio.
3. Press the **Menu/Select button**. The hours digits will begin to flash in the display.
4. Set the required hour using the **Tuning up or down buttons**.
5. Press the **Menu/Select button**. The minute digits will begin to flash in the display.
6. Set the required minute using the **Tuning up or down buttons**.
7. Press the **Menu/Select button** to confirm the alarm setting. The display will show the set alarm time. After a few seconds the display will revert to normal play mode.

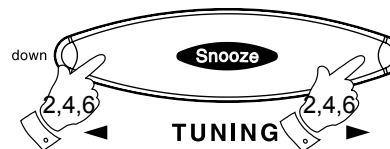
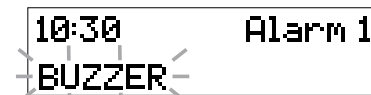
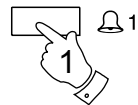

- If the radio is in standby mode the display then shows the alarm state.

Note: when alarm is set to wake by radio your clock radio will switch on to the last used station.

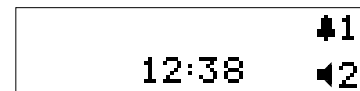

To view alarm time

- Press and release the relevant **Alarm button** to view set alarm time.



Cancelling alarms

- Whilst an alarm is sounding it can be cancelled for 24 hours by pressing the **On/Off button**.
- To permanently cancel an alarm proceed as follows:-
- Press and hold the appropriate **Alarm button** until the current alarm type is shown flashing.
- Repeatedly press and release the **Tuning up or down buttons** until "Off" is shown, then immediately press the **Menu/Select button**.

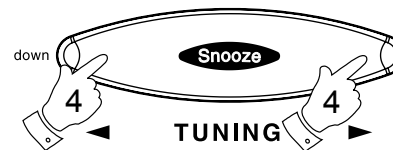
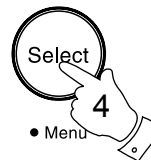
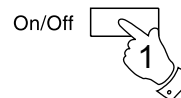

Snooze function

1. The radio or beep alarm can be silenced for 5 minutes by pressing the **Snooze button**.
The display will show **z** .
2. This sequence can be repeated during the 1 hour radio or 30 minute beep alarm period.
3. The snooze timer can be cancelled by pressing the **On/Off button**.

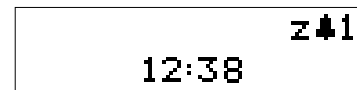
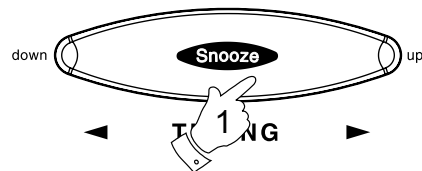

Nap timer

The Nap timer facility allows you to set the radio to wake you after a pre-determined interval (up to 2 hours) without needing to set the alarms.

1. Press and hold the **Nap button**, the current nap time will flash.
2. Repeatedly press and release **Tuning Up or Down buttons** to choose the required Nap time in minutes 10>20>30>40>50>60>70>80>90>100>110>120.
3. When the desired interval is displayed, immediately press and release the **Menu/Select button**. The display will show **N** to indicate the nap timer is active.
4. When the selected Nap timer has elapsed, the radio buzzer will sound. To cancel the buzzer press the **On/Off button**.

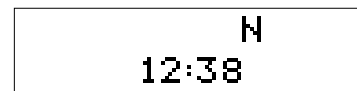
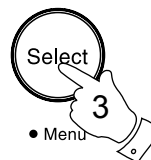
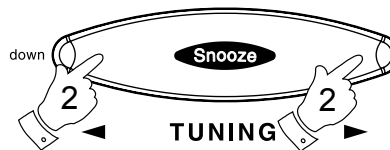

Sleep timer

Your radio can be set to turn off after a preset time has elapsed. The sleep setting can be adjusted between 1-99 minutes in 1 minute increments.

1. Press the **On/Off button** to switch on the radio.
2. Press and hold the **Sleep button** to display the sleep setting. The sleep time will flash.
3. Press the **Tuning up or down buttons** to select desired sleep time, minimum 1 minute - 99 minutes maximum.
4. Press the **Menu/Select button**. The display will show **S** to indicate the sleep timer is active.
5. Your radio will switch off after the preset sleep time has elapsed.
6. To cancel the sleep function before the preset time has elapsed, press the **On/Off button**.

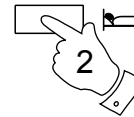
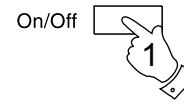

Sleep Setting
70 min

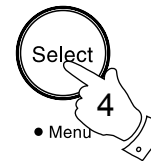
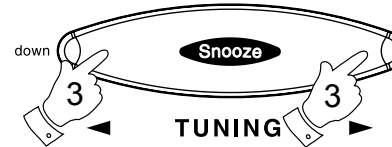

BBC 7 S DAB
Just a Minute...

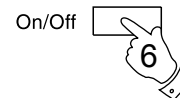

Display backlight

1. The display backlight has eight levels including off and can be set by repeatedly pressing and releasing the **Light button**.

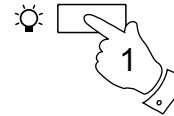

Aux in socket (3.5mm Jack)

1. Connect an audio source (ie iPod, MP3 or CD player) to the **Aux in socket**.
2. Adjust the **Volume control** on your iPod, MP3 or CD player for comfortable listening.

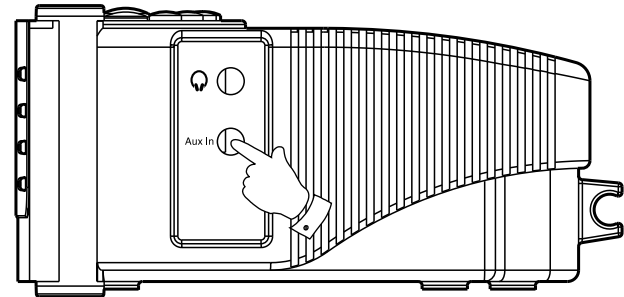

AUX IN

Aerials

As supplied your clock radio is fitted with a telescopic aerial. Should this prove inconvenient a separate wire aerial can be fitted in place of the telescopic aerial.

A spanner is provided to allow removal of the telescopic aerial. The wire aerial can then be plugged in place of the telescopic aerial.

Note : In areas where signals are weak the wire aerial may not prove to be as effective as the telescopic aerial.

Headphone socket

A 3.5mm **Headphone Socket** located on the right-hand end of your radio is provided for use with either headphones or an earpiece. Inserting a plug automatically mutes the internal loudspeaker.

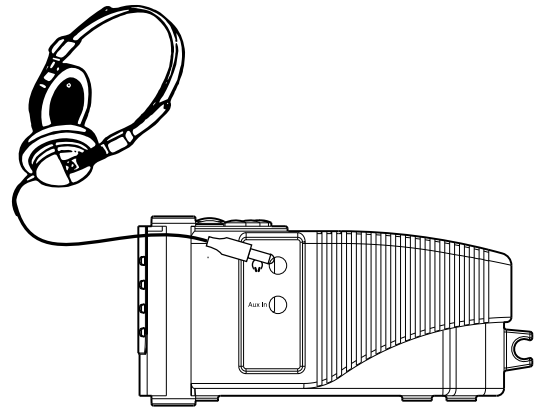

Specifications

Power Requirements

Mains AC 230 volts, 50Hz  only

Frequency Coverage

FM	87.5-108MHz
DAB	174.928 - 239.200MHz

Circuit Features

Loudspeaker 75mm 8ohms

Output Power 0.9 Watts

Headphone socket 3.5mm diameter stereo

Aerial System FM Telescopic aerial or alternative wire aerial

DAB Telescopic aerial or alternative wire aerial

The Company reserves the right to amend the specification without notice.

General

Do not allow this unit to be exposed to moisture (e.g. dripping or splashing) or to temperatures exceeding 70 degrees centigrade. It is recommended that the DAB band be used wherever possible as better results in terms of quality and freedom from interference will usually be obtained than on the FM band.

No objects filled with liquids, such as vases, should be placed on the apparatus.

The name plate is located on the underside of the unit.

Mains supply

The CRD-29 will operate from a supply of AC 230volts, 50Hz \sim only.

For your convenience this product is supplied with a plug which is fitted with a fuse of the appropriate rating. If the plug supplied is not suitable for your socket outlet, it should be removed by unscrewing the plug top, the terminal screws and removing the cable.

The correct style of plug to suit your household together with a correctly rated fuse should be fitted.

IF IN DOUBT - CONSULT A QUALIFIED ELECTRICIAN

IMPORTANT. DO NOT make any connection to the larger terminal which is marked with the letter E or by the safety earth symbol \perp or coloured Green or Green-and-yellow.

The wires in the mains lead are coloured in accordance with the following codes :-

BLUE - NEUTRAL

BROWN - LIVE

As these colours may not correspond with the coloured markings identifying the terminals in your plug, proceed as follows:-

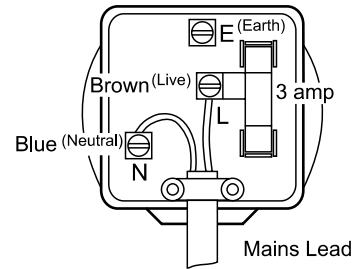

The wire coloured BLUE must be connected to the terminal marked N or coloured BLACK.

The wire coloured BROWN must be connected to the terminal marked L or coloured RED.

Fuse

This apparatus must be protected by a 3A fuse (BS1362) in a 13A plug (BS1363). If another type of plug is used a 5A fuse should be fitted in the plug, adaptor or distribution board.

IF IN DOUBT - CONSULT A QUALIFIED ELECTRICIAN.

Guarantee

This instrument is guaranteed for twelve months from the date of delivery to the original owner against failure due to faulty workmanship or component breakdown, subject to the procedure stated below. Should any component or part fail during this guarantee period it will be repaired or replaced free of charge.

The guarantee does not cover:

1. Damage resulting from incorrect use.
2. Consequential damage.
3. Receivers with removed or defaced serial numbers.

N.B. Damaged or broken telescopic aerials will not be replaced under guarantee.

Procedure:

Any claim under this guarantee should be made through the dealer from whom the instrument was purchased. It is likely that your Roberts' dealer will be able to attend to any defect quickly and efficiently, but should it be necessary the dealer will return the instrument to the company's service department for attention. In the event that it is not possible to return the instrument to the Roberts' dealer from whom it was purchased, please contact Roberts Radio Technical Services at the address shown on the rear of this manual.

These statements do not affect the statutory rights of a consumer.



Issue 1

ROBERTS RADIO TECHNICAL SERVICES

97-99 Worton Road

Isleworth Middlesex

TW7 6EG

Technical Helpline :- 020 8758 0338 (Mon-Fri during office hours)

Website: <http://www.robertsradio.co.uk>



Free Manuals Download Website

<http://myh66.com>

<http://usermanuals.us>

<http://www.somanuals.com>

<http://www.4manuals.cc>

<http://www.manual-lib.com>

<http://www.404manual.com>

<http://www.luxmanual.com>

<http://aubethermostatmanual.com>

Golf course search by state

<http://golfingnear.com>

Email search by domain

<http://emailbydomain.com>

Auto manuals search

<http://auto.somanuals.com>

TV manuals search

<http://tv.somanuals.com>