

ROBERTS

Sound for Generations

CRD-36

DAB/FM/CD/MP3/SD digital stereo clock radio with remote control

SOUND 36



Please read this manual before use

DAB
Digital Audio Broadcasting

Contents

<i>Controls</i>	2-4	<i>Snooze function</i>	30
<i>Remote handset battery replacement</i>	5	<i>Dimmer</i>	30
<i>Using your clock radio for the first time</i>	6	<i>Software version</i>	31
<i>Operating your radio - DAB</i>	7	<i>System reset</i>	31
<i>Selecting a station - DAB</i>	8	<i>Auxiliary In socket</i>	32
<i>Secondary services - DAB</i>	8	<i>Headphone socket</i>	32
<i>Display modes - DAB</i>	9	<i>General</i>	33
<i>Finding new stations - DAB</i>	10	<i>Specifications</i>	33
<i>Manual tuning - DAB</i>	11	<i>Guarantee</i>	34
<i>Signal strength display - DAB</i>	11		
<i>Dynamic Range Control (DRC) settings - DAB only</i>	12		
<i>Operating your radio - Search tuning FM</i>	13		
<i>Manual tuning - FM</i>	14		
<i>Display modes - FM RDS</i>	15		
<i>Presetting stations</i>	16-17		
<i>Compact discs / MP3-CDs</i>	18-24		
<i>Using SD cards</i>	25		
<i>Alarm</i>	26-28		
<i>Sleep function</i>	29		

Controls

(Top)

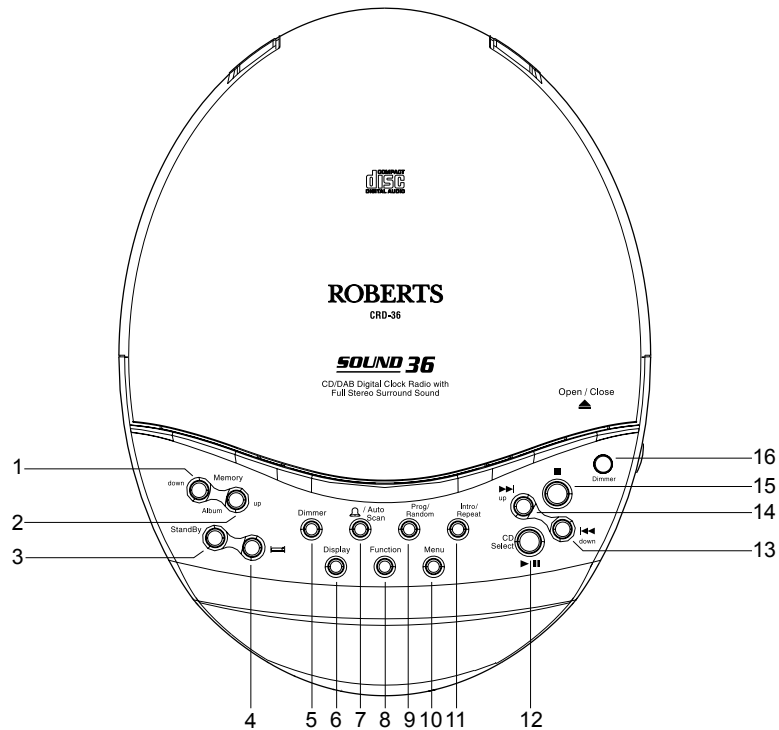

- | | | |
|-----------------------------|------------------------------|--------------------------------|
| 1. Memory/Album down button | 7. Alarm/Auto scan button | 13. Skip Down/Rewind button |
| 2. Memory/Album up button | 8. Function button | 14. Skip Up/Fastforward button |
| 3. Standby button | 9. Prog/Random button | 15. Stop button |
| 4. Sleep button | 10. Menu button | 16. Auto dimmer sensor |
| 5. Dimmer button | 11. Intro/Repeat button | |
| 6. Display button | 12. Play/Pause/Select button | |

If you need any further advice, please call our Technical Helpline on :-

020 8758 0338 (Mon-Fri)

Download from www.Somanuals.com. All Manuals Search And Download.

Controls

(Right hand side)

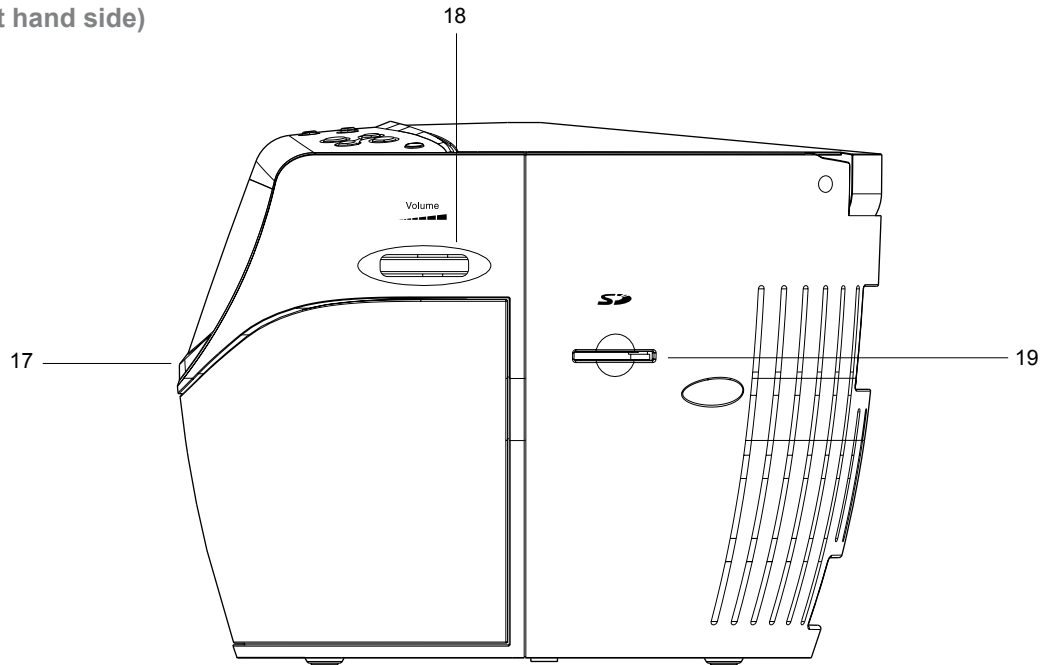

- 17. Snooze button
- 18. Volume control
- 19. SD card slot

Remote control

1. Alarm/Auto scan button
2. Function button
3. Program/Random button
4. Memory/Album down button
5. Repeat/Intro button
6. Stop button
7. Sleep button
8. Volume up button
9. Volume down button
10. Dimmer button
11. Snooze button
12. Display button
13. Tuning down/Rewind button
14. Tuning up/Fastforward button
15. Menu button
16. Play/Pause/Select button
17. Memory/Album up button
18. On/Off button

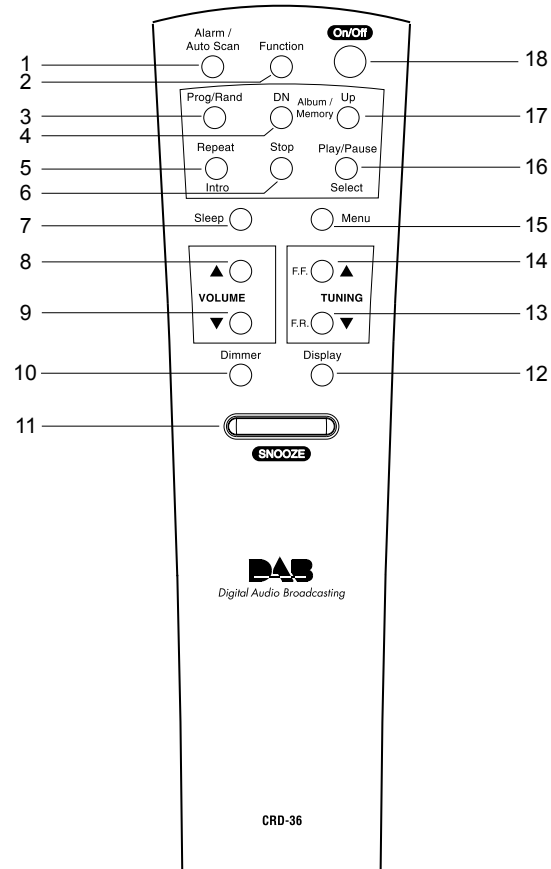

Remote handset battery replacement

1. Remove the battery cover on the rear of your remote control by pushing the battery door in and downwards.
2. Insert 2 x AAA size batteries into the compartment. Make sure the (+) and the (-) ends of the batteries are positioned as shown inside the compartment.
3. Close the battery cover.
4. If the remote is not to be used for an extended period of time it is recommended that the batteries are removed.

IMPORTANT: *The batteries should not be exposed to excessive heat such as sunshine, fire or the like. After use, disposable batteries should if possible be taken to a suitable recycling centre. On no account should batteries be disposed of by incineration.*



Using the clock radio for the first time

Your clock radio is supplied with a Mains Adaptor.

1. Place your clock radio on a flat surface.
2. Insert the adaptor plug into the DC socket located on the rear of your clock radio.

IMPORTANT: The mains adaptor is used as the means of connecting the clock radio to the mains supply. The mains socket used for the clock radio must remain accessible during normal use. In order to disconnect the clock radio from the mains completely, the mains adaptor should be removed from the mains socket outlet completely.

3. Fully extend the wire aerial located on the rear of your clock radio. The wire should be fully extended and positioned for optimum reception.
4. Plug the adaptor into a standard 13 amp mains socket outlet.
5. When your clock radio is first switched on the display will show "Setting Clock" and a station search will be performed automatically.
6. When stations have been found, the clock information will appear on the display. Press the **Display button** to toggle between showing the time only or showing both the date and time.
7. If no stations have been found "Clock not set" will be displayed. It may then be necessary to relocate your clock radio to a position giving better reception. You should then carry out an autoscans to find stations as described on page 10.

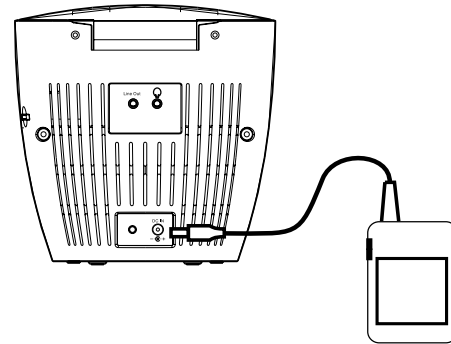

Setting Clock.

12:38

Clock not set.

Operating your radio - DAB

1. Fully extend the wire aerial.
2. If your clock radio is in standby mode, press the **Standby button** [On/off on the remote control] to switch on your clock radio.
3. Press and release the **Function button** to select DAB. The display will show "DAB" and then " Now tuning" for a few seconds.
4. If this is the first time the clock radio is used a quick scan of UK Band III DAB channels will be carried out. If the clock radio has been used before the last used station will be selected.
5. During autotune as new stations are detected the station counter on the right hand side of the display will increase and stations will be added to the list. The display will show the station name in the first line of the display and other information in the second line.
6. When the Auto tune is complete the first station (in numeric-alpha order 0...9...A....Z) will be selected.
7. If the station list is still empty after the Autotune your radio will display "Station not available".
8. If no signals are found it may be necessary to relocate your radio to a position giving better reception.



DAB

BBC 7
Now tuning...

BBC 7
Just a Minute...

Station not
available

Selecting a station - DAB

1. The top line of the display shows the name of the station currently selected.
2. Press the **Skip Up or Down buttons** [Tuning Up or Down buttons on remote control] to scroll through the list of available stations. Stop pressing the **Skip buttons** when you find the station that you wish to hear.
3. Press and release the **Select button** to select the station. The display may show "Tuning" while your radio finds the new station.
4. Adjust the **Volume** to the required settings.

Note: If after selecting a station the display continues to show "Station not available" it may be necessary to relocate your radio to a position giving better reception.

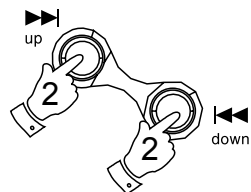

Classic

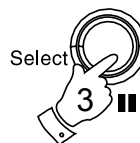

BBC 7
Now tuning...

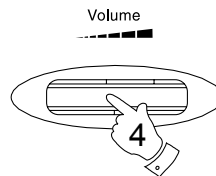

Secondary services - DAB

1. Certain radio stations have one or more secondary services associated with them. If a station has a secondary service associated with it the display will show ">>" next to the station name on the station list. The secondary service will then appear immediately after the primary service as you press the **Skip Up button** [Tuning Up button on remote control].
2. Press and release the **Select button** to select the station.

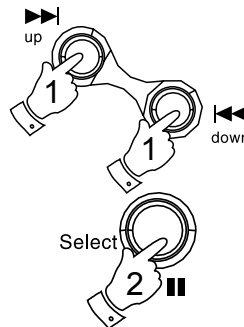

BBC Radio 5
◆ BBC 5 Live >> ◆

BBC Radio 5
◆ << BBC SportX ◆

Display modes - DAB

Your radio has seven display modes:-

1. Press the **Display button** to cycle through the various modes.



- | | |
|------------------------|---|
| a. Scrolling text | Displays scrolling text messages such as artist/track name, phone in number, etc. |
| b. Programme type | Displays type of station being listened to e.g. Pop, Classic, News, etc. |
| c. Multiplex Name | Displays name of multiplex to which current station belongs. |
| d. Time and date | Displays current time and date. |
| e. Channel & frequency | Displays channel number and frequency. |
| f. Bit rate/audio type | Displays the digital bit rate and audio type. |
| g. Signal error | Displays signal error for station being listened to. |

- | | |
|---|---------------------------|
| a | BBC 7
Just a Minute... |
| b | BBC 7
Culture |
| c | BBC 7
BBC National |
| d | BBC 7
19:17 08-06-2005 |
| e | BBC 7
11C 220.35 MHz |
| f | BBC 7
128kbps Stereo |
| g | BBC 7
Signal error 0 |

Finding new stations - DAB

As time passes new stations may become available. To find new stations proceed as follows:-

1. Press and release the **Auto Scan button**, the display will show "Scanning". Your radio will perform a scan of the UK DAB frequencies. As new stations are found the station counter on the right-hand side of the display will increase and stations will be added to the list.
2. To carry out a full scan of the entire DAB Band III frequencies press and hold down the **Auto Scan button** for more than 2 seconds and then release. The display will show "Scanning". As new stations are found the station counter on the right-hand side of the display will increase and stations will be added to the list.



Manual Tuning - DAB

Manual tuning allows you to tune directly to the various DAB Band III channels. UK DAB stations are located in the range 11B to 12D.

1. Press and release the **Menu button** until the display shows "Station order".
2. Press the **Skip Up or Down buttons** until "Manual tune" appears on the display. Press and release the **Select button**.
3. Press the **Skip Up or Down buttons** to select the required DAB channel.
4. Press and release the **Select button** the open bar in the middle shows you the minimum signal strength needed for good DAB reception. The signal bars will go up and down showing the changing signal strength as you adjust the wire aerial or your clock radio position.
5. Press and release the **Select button** to return to normal tuning mode.

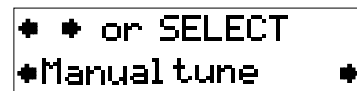
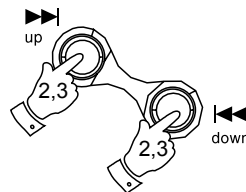

Signal strength display - DAB

1. Press and release the **Select button** the lower line of the display shows signal strength. Position your radio and angle the telescopic aerial for best reception using the signal strength display as a guide. Move your radio around and position so as to give maximum number of black rectangles on signal strength display.
2. The clear unfilled rectangle indicates minimum signal level required for satisfactory reception. Press and release the **Select button** to return to normal tuning mode.

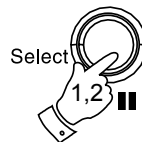

Dynamic Range Control (DRC) settings - DAB only

DRC can make quieter sounds easier to hear when your radio is used in a noisy environment. This function is only for the DAB waveband.

1. Press the **Standby button** [On/off on remote control] to switch on your radio.
2. Press and release the **Menu button** until "Station order" appears on the display.
3. Press and release the **Skip Up and Down buttons** until the display shows "DRC value".
4. Press and release the **Select button** to enter adjustment mode.
5. Press and release the **Skip Up or Down buttons** to select required DRC setting (default is 0) .
DRC 0 DRC is switched off, Broadcast DRC will be ignored.
DRC 1/2 DRC level is set to 1/2 that sent by broadcaster.
DRC 1 DRC is set as sent by broadcaster.
6. Press and release the **Select button** to confirm the setting. The display will return to radio mode.

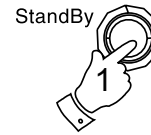

◆ ◆ or SELECT
◆ DRC value ◆

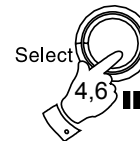
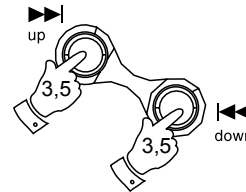

Operating your radio - Search tuning FM

1. Fully extend the wire aerial.
2. Press the **Standby button** [On/Off button on the remote control] to switch on your radio.
3. Press and release the **Function button** until the FM band is selected.
4. Press the **Skip Up button** and then press the **Auto scan button**, your radio will scan in an upwards direction (low frequency to high frequency) and stop automatically when it finds a station of sufficient strength.
5. After a few seconds the display will update. If the FM band is selected the display will show the station name if available. The display will also show "S" and "RDS" after the station name on the upper line if the station is with stereo and RDS function.
6. To find other stations press and hold the **Autoscan button** as before.
7. To scan the FM band in a downwards direction (high frequency to low frequency) press the **Skip Down button** and then press **Auto scan button**.
8. When the waveband end is reached your radio will recommence tuning from the opposite waveband end.
9. Adjust the **Volume** to the required settings.
10. To switch off your radio press the **Standby button**.

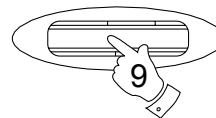
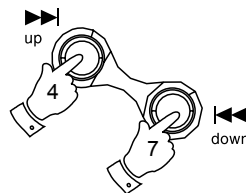
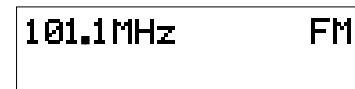
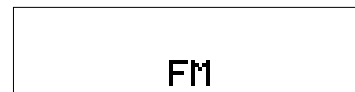

Manual tuning - FM

1. Press the **Standby button** [On/Off on remote control] to switch on your radio.
2. Press and release the **Function button** to select the FM.
3. Fully extend the **wire aerial** for FM reception.
4. Repeatedly press the **Skip Up and Down buttons** to tune to a station. The frequency will change in steps of 50kHz on FM.
5. When the waveband end is reached the radio will recommence tuning from the opposite waveband end.
6. Set the **Volume** to the desired settings.
7. To switch off your radio press the **Standby button**.

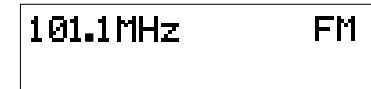
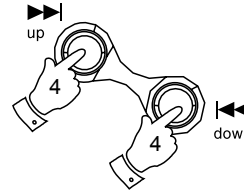
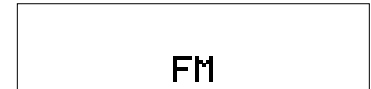

Volume

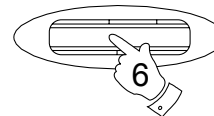

Display modes - FM

On FM the bottom line of the display can be set to any of the following modes:-

1. Press the **Display button** to cycle through the various modes.
 - a. Scrolling text Displays scrolling text messages such as artist/track name, phone in number etc.
 - b. Programme Type Displays type of station being listened to e.g. Pop, Classic, News, etc.
 - c. Time and date Displays current time and date.
 - d. Frequency Displays frequency of the station being listened to.



- a

Classic FM	FM
The latest news	
- b

Classic FM	FM
Classical Music	
- c

Classic FM	FM
12:02 16-06-2005	
- d

Classic FM	FM
101.1MHz	

Presetting stations

There are 10 memory presets on each of the DAB and FM wavebands.

1. Press the **Standby button** [On/Off button on remote control] to switch on your radio.
2. Tune to the required station as previously described.
3. Press the **Prog/Random button**, the display will show "Preset" with "01" flashing.
4. Use the **Memory Up or Down buttons** to select the desired preset number under which you wish to store the station.
5. Press and hold down the **Prog/Random button** until the display shows e.g. "Preset 1 saved". The station will be stored under the chosen preset button. Repeat this procedure for the remaining presets.
6. Stations stored in preset memories may be overwritten by following the above procedure.

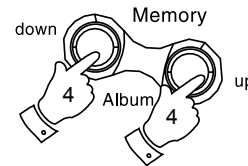
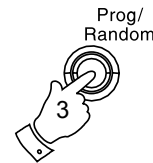

BBC R2
Preset 1 saved

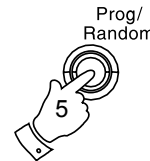

Recalling a preset station

1. Press the **Standby button** [On/Off button on remote control] to switch on your radio.
2. Select the required waveband by pressing the **Function** button.
3. Press the **Memory Up or Down buttons** to select the desired preset number.
4. Your radio will tune to the station stored in preset memory.

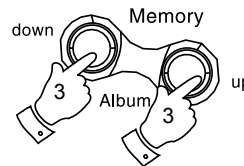
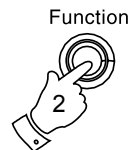

Compact discs

Use only Digital Audio CDs which have the  symbol.

Never write on a CD or attach any sticker to the CD. Always hold the CD at the edge and store it in its box after use with the label facing up.

To remove dust and dirt, breathe on the CD and wipe it with a soft, lint free cloth in a straight line from the centre towards the edge.

Cleaning agents may damage the CD.

Do not expose the CD to rain, moisture, sand or to excessive heat. (e.g from heating equipment or in motor cars parked in the sun).

CD-R/CD-RW discs

Your CRD-36 can playback CD-DA format audio CD-R/CD-RW discs that have been finalised* upon completion of recording.

Your CRD-36 may fail to playback some CD-R/CD-RW discs due to poor recording and wide variation in quality of the CD-R/CD-RW disc.

*Finalising enables a CD-R/CD-RW disc to playback on audio players such as your CRD-36.

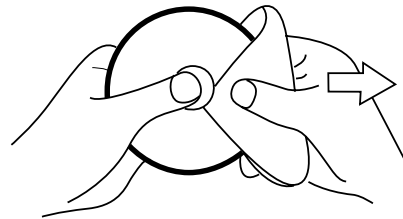

Warning

CLASS 1 LASER PRODUCT means that the laser's construction makes it inherently safe so that the legally prescribed maximum permissible radiation values can never be exceeded.

Caution: Using any equipment or devices other than those described and specified in these operating instructions, or tampering with the unit in any way, can result in dangerous exposure to radiation.



MP3 CD Mode

The CRD-36 is able to play CD-R and CD-RW discs containing MP3/WMA files.

In MP3 mode the terms "album" and "file" are very important. "Album" corresponds to a folder on a PC, "File" to a PC or a CD -DA track. The device reads MP3 files with a maximum of 255 files per album. An MP3 CD may not contain more than 512 files or albums in total. MP3 files must be created with an audio sample rate of 44.1kHz (this is normal for files created from CD audio content).

When burning CD-R and CD-RWs with audio files, various problems may arise which could lead to interference in playback. This can be caused by faulty software or hardware settings or by the CD being used. Should such problems arise, contact the customer services of your CD burner or software manufacturer or look for relevant information, for example on the internet. When you are making audio CDs, observe all legal guidelines and ensure that the copyright of third parties is not infringed.

Inserting a CD

1. To open the CD compartment, push the **OPEN/CLOSE** button on the top panel.
2. Put the CD on the spindle until it clicks into place and close the CD door. The CD player will scan the contents of the CD, "READING" will appear on the display.

CDDA: the total number of tracks and total playing time will appear on the display.

MP3: The total number of files and folders will appear on the display.

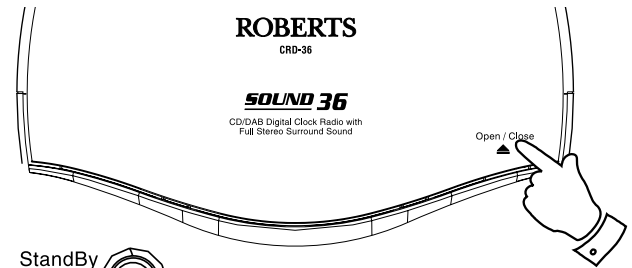

Function



Volume

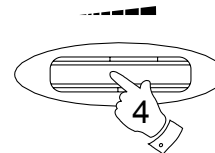

Playing a CD

1. Press the **Standby** button to switch on your radio.
2. Press the **Function** button to choose CD as the input source.
3. Press the **Play/Pause Select** button to start playback. The display will show the first track number and the play symbol ► will appear on the display.

CDDA: The current track number and elapsed playing time.

MP3: The current file number for 3 seconds, then change to show the file name, ID3 tag and the elapsed playing time.

4. Adjust the **Volume** to the required settings.

- To pause playback press the **Play/Pause button** the pause symbol **||** flashes on the display.

CDDA: The current track number and the elapsed playing time stay on the display.

MP3: File name with ID3 tag scrolls, the elapsed playing time stay on the display.



- To resume playback press the **Play/Pause button** again.

- To stop playback, press the **Stop button**. Resume to normal display.

- To take out the CD, push the **OPEN/CLOSE button** on the top panel of the device. The CD door should only be opened when the CD is in stop mode.



Selecting a track

- CDDA: Whilst the CD is playing, press either the **Skip Up or Down buttons** to change the desired track. You can skip tracks when the player is in stop mode. Press the **Play/Pause button** to play the selected track.

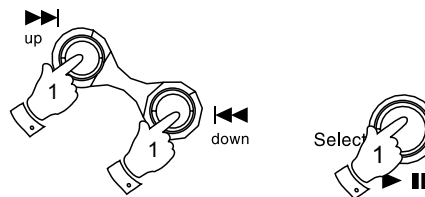

- MP3: Whilst the CD is playing, press either the **Memory/Album Up or Down buttons** to change to the desired album, then press either the **Skip Up or Down buttons** to change to the desired track. You can also skip albums or tracks when the player is in stop mode. Press the **Play/Pause button** to play the selected track.

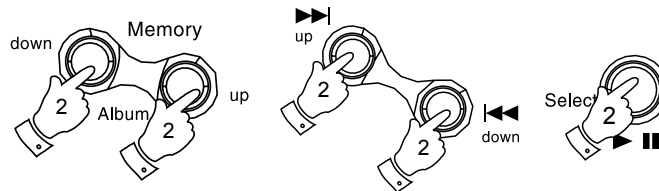

Search function

1. Whilst the CD is playing, press and hold down either the **Skip Up** or **Down button**. Release the button when the desired part of the track is reached.

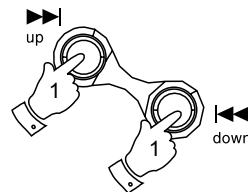

CD repeat mode

1. Whilst the CD/MP3 is playing press the **Repeat/Intro button**.
CDDA: Repeat 1, → Repeat ALL , → Normal Play
MP3: Repeat 1, → Repeat Album, → Repeat ALL , → Normal Play

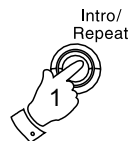

CD Intro mode

1. When in the stop mode, press the **Repeat/Intro button** once to play the first 10 seconds intro of all the tracks on the disc. "Intro" appears on the display.
2. To cancel intro, press the **Stop button**.

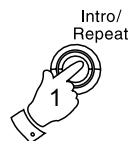

CD Random play

1. Whilst the CD is playing, press the **Prog/Random button** to play all tracks on the CD in random order. "RAND" will appear on the display. The tracks are played in random order until all tracks have been played.
2. Press the **Prog/Random button** again to return to normal play. "RAND" disappears from the display.



Creating a play list (Program Play - CD only)

By programming the player you can play up to 20 tracks in any desired order.

1. Whilst the CD is in Stop mode, press the **Prog/Random button**. The display will show "P-01".
CDDA: Select the first track using the **Skip Up or Down buttons**. "PROG" will flash on the display. Store this track by pressing the **Prog/Random button**.
2. Repeat the above steps until you have completed your program.
3. Press the **Play/Pause button** to commence play of selected tracks.

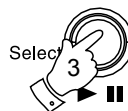
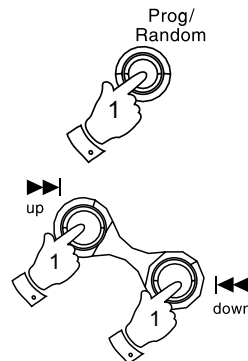

Checking and Editing a programme

Whilst the CD is in stop mode, you can check and edit the program.

1. Press the **Prog/Random** button repeatedly. The display will show the play list that you have already programmed.
2. You can edit the playlist. When the desired track that you want to edit is reached, follow the procedure for creating a play list overleaf.



Erasing a programme

1. Press the **Stop** button under programme mode to erase the program. Programs are also erased by changing to standby, radio or SD mode.



Using SD cards

Secure Digital (SD) cards can be used with the CRD-36 for playback of MP3 files.

Many different brands and capacities of SD card are available. Your CRD-36 has been tested with the most popular cards up to 2 GB. However, there are many different card variants available and not all cards can be guaranteed to work in the CRD-36.

SD card slot is located on the right hand side of the unit.

Inserting and removing a card

To insert an SD card into your radio push the card **label side downwards** and **gold contacts first** into the SD card slot on the front of your radio until it clicks.

To remove the card push the card in slightly and it will pop out allowing removal.

1. To select SD card mode press the **Function button**.

Playback control in SD card mode is similar to CD-MP3 mode see page 19.

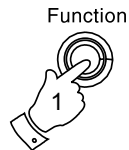
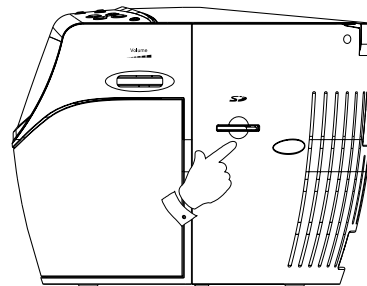

Alarm mode

Your clock radio has four alarms which can be set to wake you by radio (FM or DAB), CD, SD or beep type alarm. Each alarm can be set to sound:

Sound once only

Everyday

Monday to Friday

Monday to Saturday

Saturday to Sunday

The alarms can only be set with the clock radio in standby mode.

1. Press and hold the **Alarm button** for 3 seconds "Alarm" appears with "1" flashing on the display.

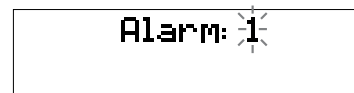

Note: If no buttons are pressed for 10 seconds, the radio will exit the alarm setup. To exit the alarm menu at any time press the Menu button.

2. Press the **Skip Up or Down buttons** to select between Alarm 1 to Alarm 4.

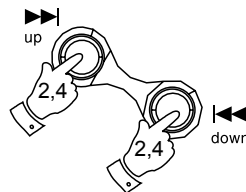

3. Press the **Alarm button** to enter the Alarm setup.

4. Hours digits flash on the display. Press the **Skip Up or Down buttons** to select the desired alarm hour, then press the **Alarm button** to confirm setting.

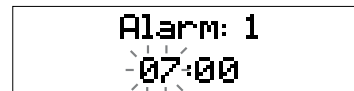
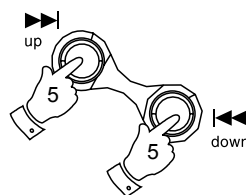

5. Minute digits flash on the display. Press the **Skip Up or Down buttons** to select the desired alarm minute.

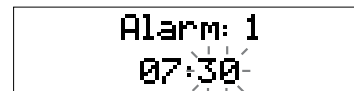

If you need any further advice, please call our Technical Helpline on :-

020 8758 0338 (Mon-Fri)

Download from www.Somanuals.com. All Manuals Search And Download.

- Press the **Alarm button** to confirm the setting and enter the alarm day option. You can select between once, daily, Mon-Fri, Mon-Sat and Sat-Sun.

Display

Once	(Once)	- Will sound at one time only
Mon-Sun	(Daily)	- Will sound every day
Mon-Fri	(1-5)	- Will sound every weekday
Mon-Sat	(1-6)	- Will sound from Mon to Saturday
Sat-Sun	(6-7)	- Will sound only on weekends

- Press the **Skip Up or Down buttons** to select the desired Alarm day option.

- Press the **Alarm button** to select the alarm mode.

- Press the **Skip Up or Down buttons** to select the desired alarm mode. You can choose between OFF, BUZZER, DAB, CD, SD and FM. Then press the **Alarm button** to confirm setting. When the alarm mode is set to "OFF" the alarm will be disabled.

- Press the **Skip Up or Down buttons** to adjust the alarm volume. Then press the **Alarm button** to confirm setting.

- Then "Snooze 5 minutes" appears on the display. Press the **Skip Up or Down buttons** to select the desired snooze timer from 5, 10, 15 and 20 minutes cyclically. Then press the **Alarm button** to confirm setting.

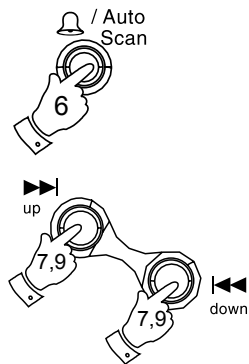

Alarm: 1
Buzzer

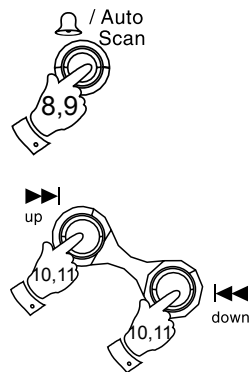

Note: When the alarm is set to wake by radio, the last used station will be switched on at the alarm time.

When the alarm activates, the volume will start from minimum and increase in level every 2-3 seconds.

Make sure that the CD is inserted when choosing CD as alarm mode. If CD is not inserted, buzzer will automatically replace the CD alarm mode.

View the alarm time

1. Repeatedly press the **Alarm button** to view Alarm 1 to Alarm 4 time.

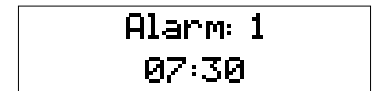

Sleep function

Your clock radio can be set to turn off after a preset time has elapsed. The sleep setting can be adjusted between 0 and 90 minutes in 10 minute increments.

1. To set the desired sleep time, press the **Sleep button** to enter the sleep setup. "Sleep 90" will be displayed.
2. Repeatedly press the **Sleep button** to adjust sleep countdown time ranging from 0-90 minutes in 10 minute increments or to OFF to permanently cancel the sleep function.
3. During countdown period, press **Sleep button** to view countdown time left.
4. Your radio will switch off after the preset sleep time has elapsed.
5. To cancel the sleep function before the preset time has elapsed, press the **Standby button** or the **Snooze button**.

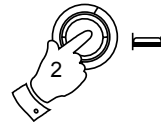
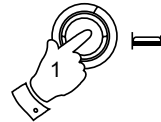

Snooze

1. When the alarm sounds, pressing the **Snooze button** will silence the alarm for the selected number of minutes. The snooze setting can be adjusted between 5, 10, 15 and 20 minutes in 5 minute increments in the Alarm settings.
2. To set the snooze to the desired snooze time, follow the snooze timer instructions in the alarm settings page 26-28.



Dimmer

1. Press the **Dimmer button** to change the backlight illumination level between low-mid-high in cycle.



Auto Dimmer

1. The auto Dimmer located on the top of your clock radio will automatically adapt the intensity of the display to suit ambient room lighting.

Software version

The software display cannot be altered and is just for your reference.

1. To view which software version your clock radio has, press the **Menu button** to enter the menu setup.
2. Press the **Skip Up or Down buttons** until "SW Version" together with the Version number appears on the display.

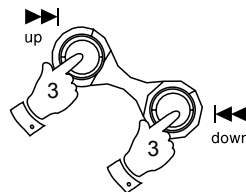

System Reset

If your radio fails to operate correctly, or some digits on the display are missing or incomplete, carry out the following procedure.

1. Whilst in DAB or FM mode press and hold the **Menu button** until the display shows "Press SELECT to confirm reset".
2. Press and release the **Select button** to select system reset.

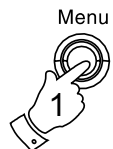

Press SELECT to
confirm reset...



A full reset will be performed and the station list together with any preset stations will be erased.

In case of malfunction due to electrostatic discharge, just reset the product (reconnect of power source may be required) to resume normal operation.

Aux in socket (3.5mm Jack)

1. Repeatedly press and release the **Function button** until "Aux" is selected.
2. Connect a stereo or mono audio source (ie iPod, MP3 or CD player) to the **Aux in socket**.
3. Adjust the **Volume control** on your iPod, MP3 or CD player for comfortable listening.

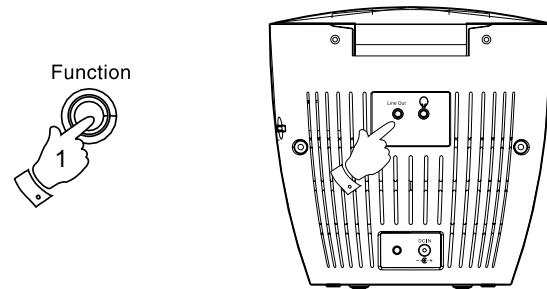

Headphone socket

1. A 3.5mm **Headphone Socket** located on the rear of your radio is provided for use with headphones. Inserting a plug automatically mutes the internal loudspeaker.

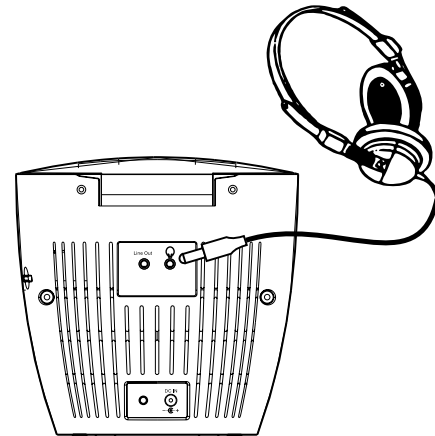

General

Do not allow this radio to be exposed to water, steam or sand. Do not leave your radio where excessive heat could cause damage. It is recommended that the DAB band be used wherever possible as better results in terms of quality and freedom from interference will usually be obtained than on the FM band.

- The name plate is located on the underside of your clock radio.

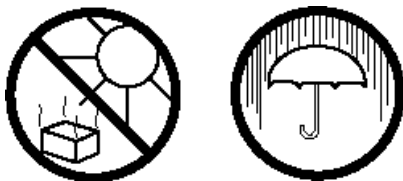

- No objects filled with liquids, such as vases, shall be placed on the clock radio.
- It is recommended to operate the product such that there is a minimum distance (10cm recommended) to adjacent objects in order to ensure good ventilation.
- The ventilation of the product should not be restricted by covering it or its ventilation openings with items such as newspapers, table-cloths, curtains etc.
- No naked flame sources such as lighted candles should be placed on the product.
- It is recommended to avoid using or storing the product at extremes of temperature. Avoid leaving the unit in cars, on window sills in direct sunlight etc.

Specifications

Power Requirements

Mains	AC 230 volts, 50Hz  only
Battery (Remote control)	2 x AAA

Frequency Coverage

FM	87.5-108MHz
DAB	174.928 - 239.200MHz

Circuit features

Loudspeaker	2 x 76 mm 8 ohms	
Headphone socket	3.5mm dia	
Auxiliary in socket	3.5mm dia	
Aerial System	FM	Wire aerial
	DAB	Wire aerial

The Company reserves the right to amend the specification without notice.

Guarantee

This instrument is guaranteed for twelve months from the date of delivery to the original owner against failure due to faulty workmanship or component breakdown, subject to the procedure stated below. Should any component or part fail during this guarantee period it will be repaired or replaced free of charge.

The guarantee does not cover:

1. Damage resulting from incorrect use.
2. Consequential damage.
3. Receivers with removed or defaced serial numbers.

Procedure:

Any claim under this guarantee should be made through the dealer from whom the instrument was purchased. It is likely that your Roberts' dealer will be able to attend to any defect quickly and efficiently but should it be necessary the dealer will return the instrument to the Company's service department for attention. In the event that it is not possible to return the instrument to the Roberts' dealer from whom it was purchased, please contact Roberts Radio Technical Services at the address shown overleaf.

These statements do not affect the statutory rights of a consumer.



Issue 2

ROBERTS RADIO TECHNICAL SERVICES

97-99 Worton Road

Isleworth Middlesex

TW7 6EG

Technical Helpline :- 020 8758 0338 (Mon-Fri during office hours)

Website: <http://www.robertsradio.co.uk>



Free Manuals Download Website

<http://myh66.com>

<http://usermanuals.us>

<http://www.somanuals.com>

<http://www.4manuals.cc>

<http://www.manual-lib.com>

<http://www.404manual.com>

<http://www.luxmanual.com>

<http://aubethermostatmanual.com>

Golf course search by state

<http://golfingnear.com>

Email search by domain

<http://emailbydomain.com>

Auto manuals search

<http://auto.somanuals.com>

TV manuals search

<http://tv.somanuals.com>