

# ROBERTS

Sound for Generations

# R9903

3 Band Portable Radio

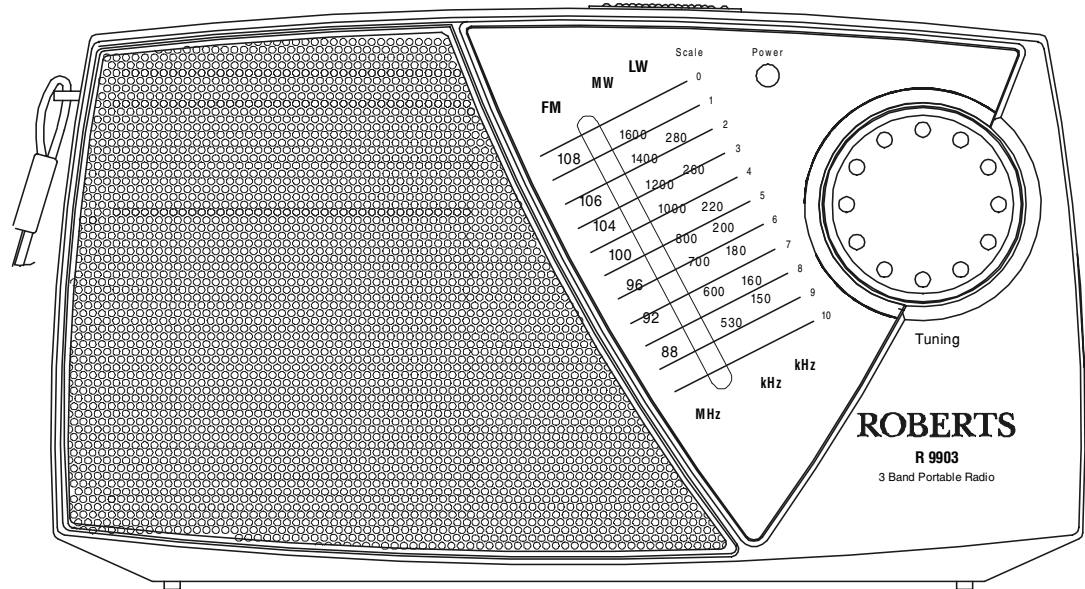

Please read this manual before use

## Controls

(Top)

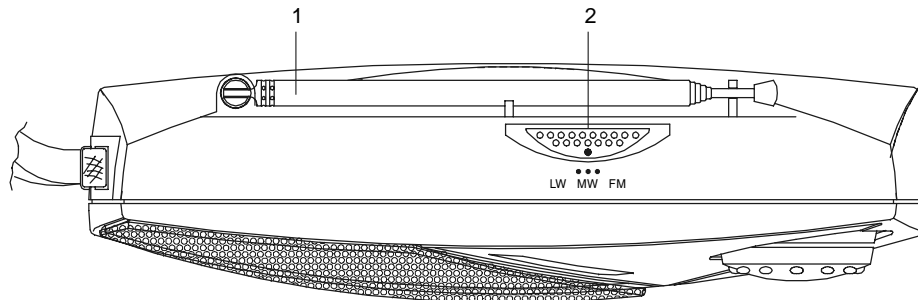

(Front)

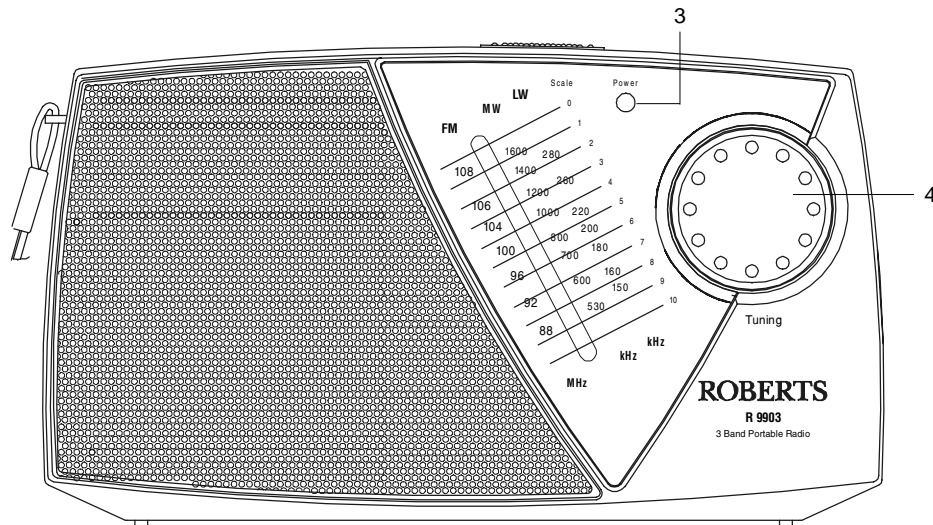

1. Telescopic Aerial
2. Waveband switch
3. Power LED
4. Tuning control

## Controls

(Left side)

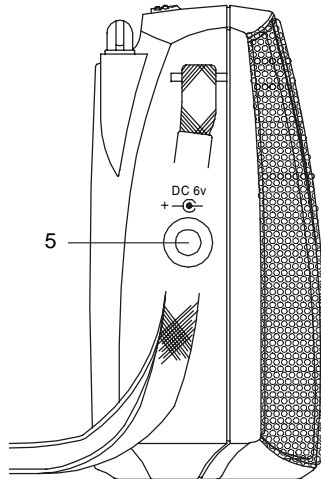

(Right side)

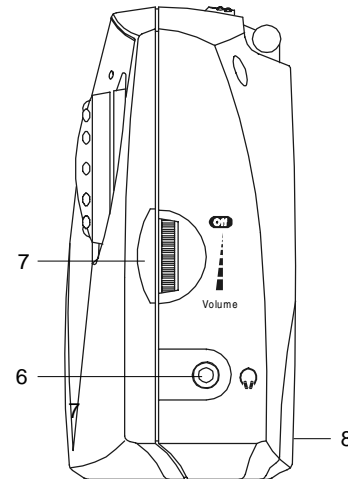

- 5. DC input socket
- 6. Headphone socket
- 7. Volume control
- 8. Battery compartment

*If you need any further advice, please call our Technical Helpline on :-*

*0181 758 0338 (Mon-Fri)*

Download from [www.Somanuals.com](http://www.Somanuals.com). All Manuals Search And Download.

## Battery operation

1. Remove the **Battery cover** on the rear of the unit by pushing the catch in the direction of the arrow.
2. Insert four LR6 (AA size) batteries into the spaces in the compartment. Take care to ensure all batteries are inserted with the correct polarity as shown inside the battery compartment. Replace the battery cover.
3. Reduced power, distortion, and a 'stuttering' sound are all signs that the batteries may need replacing.
4. If the radio is not to be used for any extended period of time it is recommended that the batteries are removed from the radio.

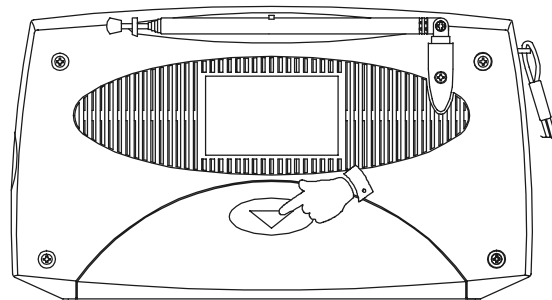

## Operation via an AC adaptor (not included)

The AC adaptor for use with the R9903 should provide 6 volts DC output at 300mA centre pin negative (Roberts type PU6-B).

1. Place your radio on a flat surface.
2. Plug the adaptor lead into the **DC input socket** located on the left hand side end of your radio ensuring that the plug is pushed fully into the socket. The batteries will be automatically disconnected.
3. Plug the adaptor into a wall socket and switch on.

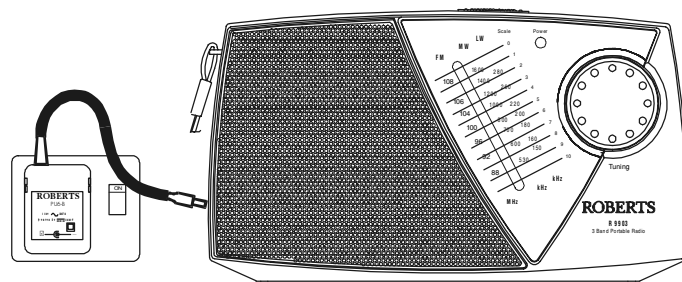

## Operating your radio

1. Turn on your radio by rotating the **Volume control** clockwise until a click is heard. The **Power LED** will light up
2. Set the **Waveband selector** to the required waveband.
3. Adjust the **Volume control** until a hissing sound is heard.
4. Rotate the **Tuning knob** to select the desired station. On MW and LW the **Tuning scale** is marked in kilohertz (kHz). On FM the **Tuning scale** is marked in Megahertz (MHz)
5. For MW and LW reception rotate your radio to the position giving best reception.
6. For FM reception fully extend the **Telescopic aerial** and then angle and rotate for best reception. A knuckle joint at the base of the aerial allows this movement and an angle of 45 degrees will usually be satisfactory.
6. Adjust the **Volume control** to the required sound level.
7. To turn off your radio rotate the **Volume control** fully anticlockwise until a click is heard.

Note : The telescopic aerial is inoperative on MW and LW.

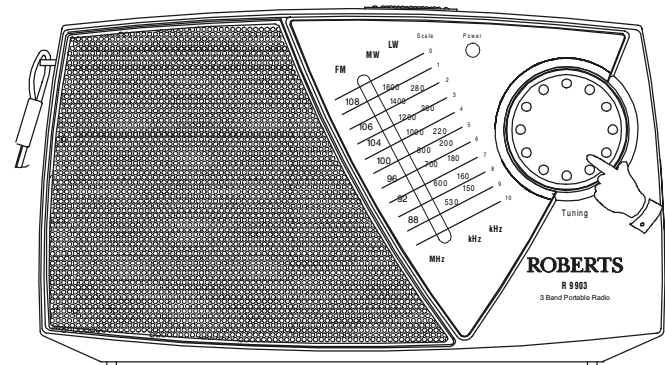
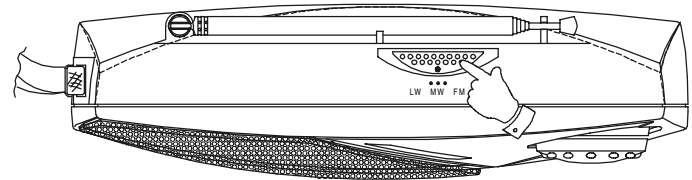
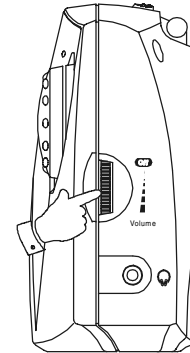

## Headphones

1. A **Headphone Socket** (3.5mm) located on the right hand end of your radio is provided for use with either headphones or an earpiece. Inserting the headphone plug automatically mutes the internal loud-speaker.

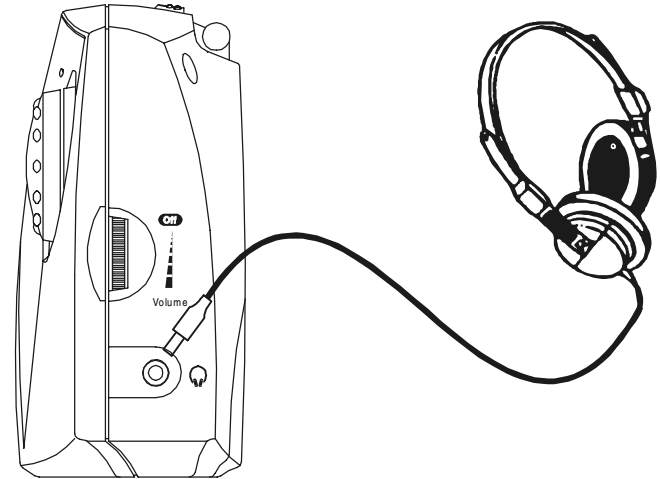

---

## General

Do not allow this unit to be exposed to water, steam or sand. Do not leave your radio where excessive heat could cause damage such as in a parked car where the heat from the sun can build up even though the outside temperature may not seem too high. It is recommended that the FM band be used where ever possible as better results in terms of quality and freedom from interference will usually be obtained than on the MW or LW bands.



## Specifications

### Power Requirements

Batteries 4 x LR6 (AA size)  
External DC 6 Volts  @ 300mA  
centre pin negative (-).

### Battery Life

Approx. 80hrs of listening for 4 hours a day at normal volume using alkaline cells.

### Frequency Coverage

FM 87.5-108MHz  
MW 522-1620kHz  
LW 144-281kHz

## Circuit Features

Loudspeaker	77mm
Output Power	400 mW into 8ohms
Headphone socket	3.5mm dia
Aerial System	FM Telescopic aerial
	MW Built-in Ferrite aerial
	LW Built-in Ferrite aerial

### ROBERTS RADIO LIMITED

PO BOX 130  
MEXBOROUGH  
SOUTH YORKSHIRE  
S64 8YT

*The Company reserves the right to amend the specification without notice.*

*If you need any further advice, please call our Technical Helpline on :-*

*0181 758 0338 (Mon-Fri)*

Download from [www.Somanuals.com](http://www.Somanuals.com). All Manuals Search And Download.

## Guarantee

This instrument is guaranteed for twelve months from the date of delivery to the original owner against failure due to faulty workmanship or component breakdown, subject to the procedure stated below. Should any component or part fail during this guarantee period it will be repaired or replaced free of charge.

The guarantee does not cover:

1. Damage resulting from incorrect use.
2. Consequential damage.
3. Receivers with removed or defaced serial numbers.

N.B. Damaged or broken telescopic aerials will not be replaced under guarantee.

Procedure:

Any claim under this guarantee should be made through the dealer from whom the instrument was purchased. It is likely that your Roberts' dealer will be able to attend to any defect quickly and efficiently, but should it be necessary the dealer will return the instrument to the company's service department for attention. In the event that it is not possible to return the instrument to the Roberts' dealer from whom it was purchased, please contact Roberts Radio Technical Services department at the address shown below before taking further action.

*These statements do not affect the statutory rights of a consumer.*

### **ROBERTS RADIO TECHNICAL SERVICES DEPARTMENT**

97-99 Worton Road  
Isleworth Middlesex  
TW7 6EG

Technical Helpline:- 0181 758 0338 (Mon-Fri)

Issue 1





## Free Manuals Download Website

<http://myh66.com>

<http://usermanuals.us>

<http://www.somanuals.com>

<http://www.4manuals.cc>

<http://www.manual-lib.com>

<http://www.404manual.com>

<http://www.luxmanual.com>

<http://aubethermostatmanual.com>

Golf course search by state

<http://golfingnear.com>

Email search by domain

<http://emailbydomain.com>

Auto manuals search

<http://auto.somanuals.com>

TV manuals search

<http://tv.somanuals.com>