

ROBERTS

Sound for Generations

R9927

3 Band Mains Battery
Portable Radio



Please read this manual before use

Contents

<i>Important Information</i>	1
<i>Controls</i>	2-3
<i>Battery Operation</i>	4
<i>Mains Operation</i>	4
<i>Operating your radio - FM</i>	5
<i>Operating your radio - Medium and Long wave</i>	6
<i>Headphones</i>	7
<i>General</i>	7
<i>Specifications</i>	8
<i>Notes</i>	9
<i>Guarantee</i>	10

Controls

(Top)

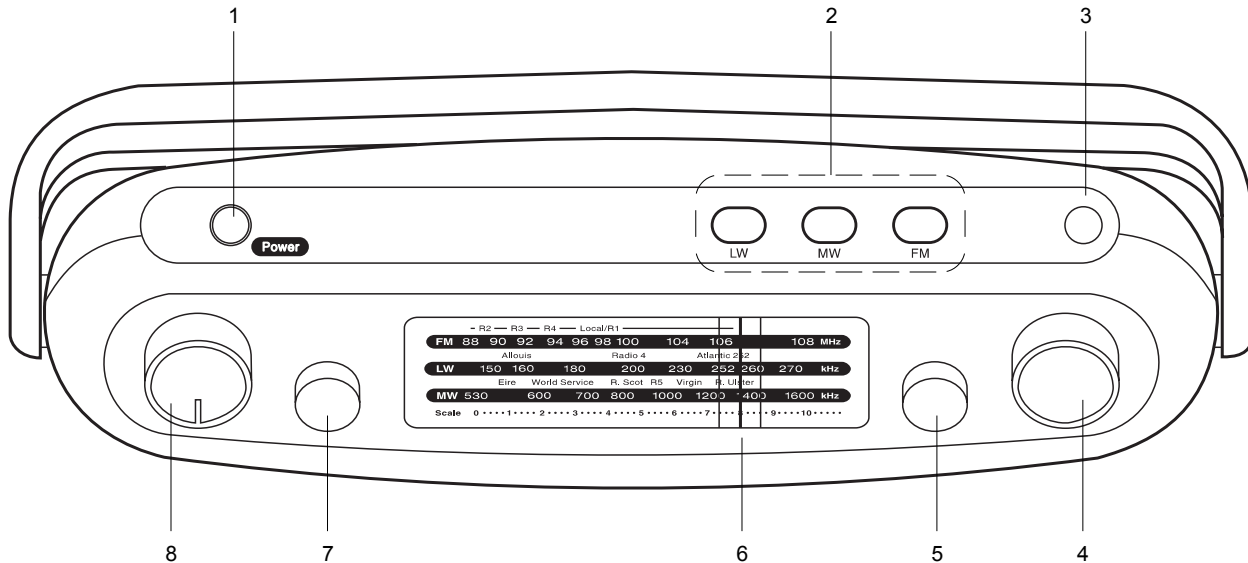

- | | |
|----------------------|-------------------|
| 1. Power button | 5. Treble control |
| 2. Waveband buttons | 6. Dial pointer |
| 3. Telescopic aerial | 7. Bass control |
| 4. Tuning control | 8. Volume control |

Controls

(Rear)

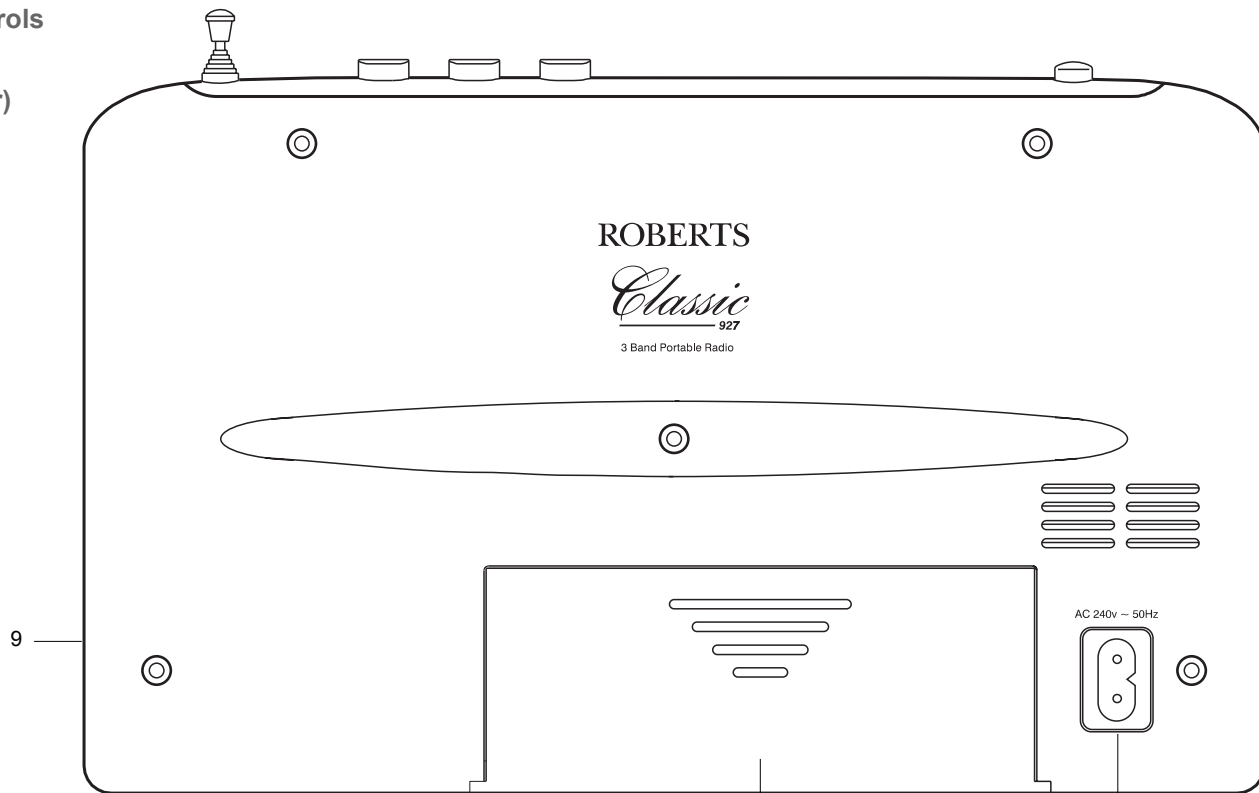

9. Headphone socket (on side)

10. Battery compartment

11. Mains socket

Battery operation

1. Remove the **Battery cover** on the rear of the unit by pushing the battery door in and downwards.
2. Insert four LR14 (C size) batteries into the spaces in the compartment. Take care to ensure all batteries are inserted with the correct polarity as shown inside the battery compartment. Replace the battery cover.
3. Reduced power, distortion and a 'stuttering' sound are all signs that the batteries may need replacing.
4. If the radio is not to be used for any extended period of time it is recommended that the batteries are removed from the radio.
We would recommend for economy that the R9927 is used on the mains whenever possible with battery operation for occasional or stand-by use only.

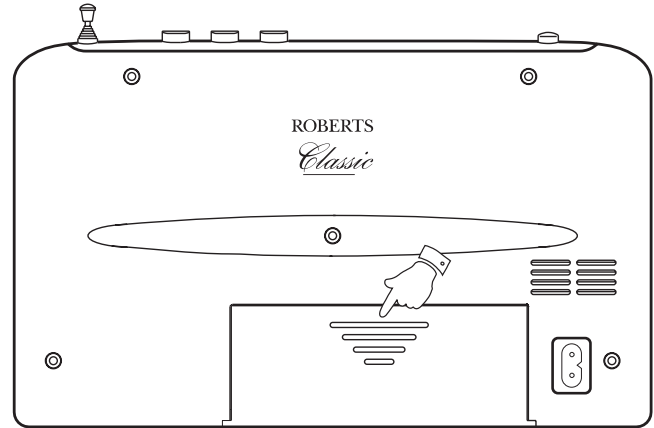

Mains operation

1. Place your radio on a flat surface.
2. Plug the mains lead into the **Mains socket** located on the rear of your radio ensuring that the plug is pushed fully into the socket.
3. Plug the other end of the mains lead into a wall socket and switch on the wall socket.

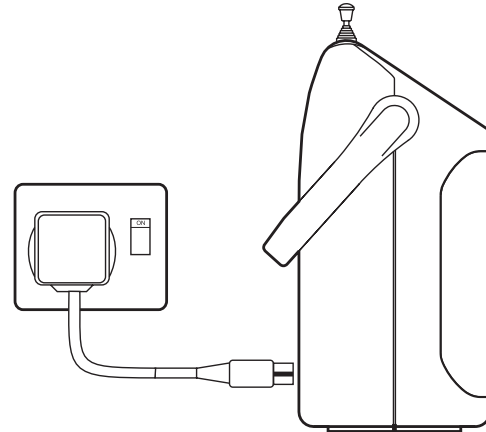

If you need any further advice, please call our Technical Helpline on :-

020 8758 0338 (Mon-Fri)

Download from www.Somanuals.com. All Manuals Search And Download.

Operating your radio FM

1. Switch on your radio by pressing the **Power button**.
2. Press the **FM button** to select the FM waveband.
3. Adjust the **Volume control** until a hissing sound is heard.
4. Rotate the **Tuning control** to select the desired station. On FM the **Tuning scale** is marked in Megahertz (MHz).
5. For FM reception fully extend the **Telescopic aerial** and then angle and rotate for best reception
6. Adjust the **Volume** to the required setting.
7. Adjust the **Bass and Treble controls** to the required settings.
8. To switch off your radio press the **Power button**.

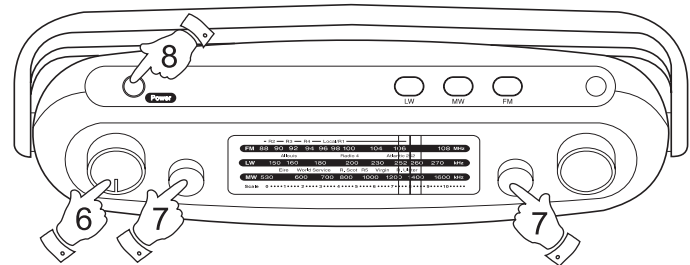
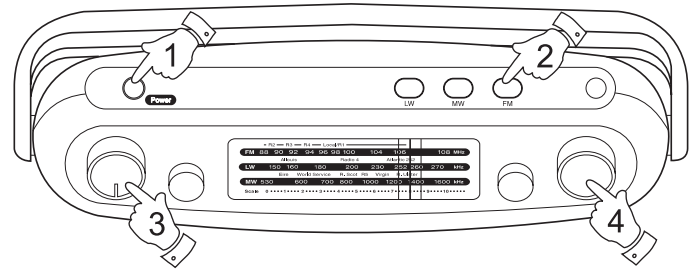

Operating your radio (Medium and Long wave)

1. Switch on your radio by pressing the **Power button**.
2. Press either the **MW** or **LW** button.
3. Adjust the **Volume control** until a hissing sound is heard.
4. Rotate the **Tuning control** to select the desired station. On MW and LW the **Tuning scale** is marked in kilohertz (kHz).
5. For MW or LW reception rotate your radio to the position giving best reception.
6. Adjust the **Volume** to the required setting.
7. Adjust the **Bass and Treble controls** to the required settings. Rotating the controls clockwise increases the bass or treble.
8. To switch off your radio press the **Power button**.

Note : The telescopic aerial is inoperative on MW and LW.

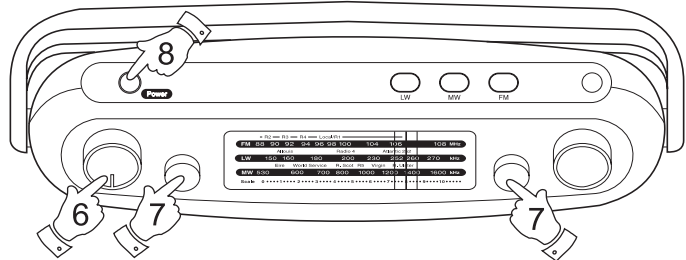
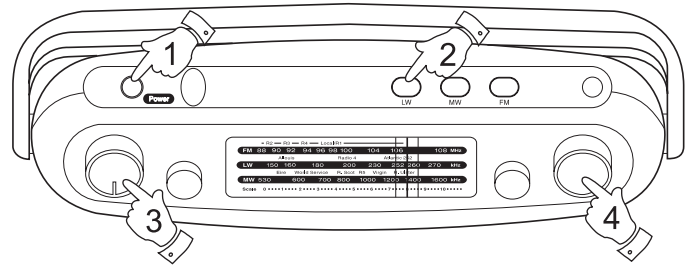

Headphones

1. A **Headphone Socket** (3.5mm) located on the right hand end of your radio is provided for use with either headphones or an earpiece. Inserting the headphone plug automatically mutes the internal loudspeaker.

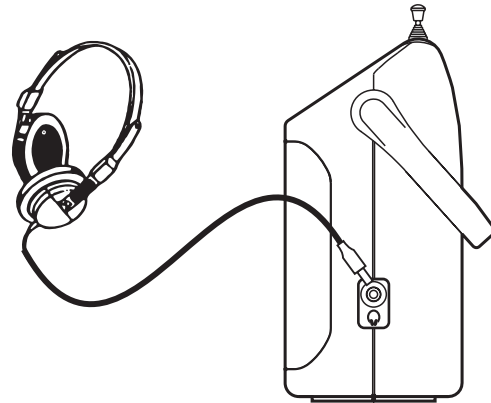

General

Do not allow this unit to be exposed to dripping or splashing. Do not leave your radio where excessive heat could cause damage such as in a parked car where the heat from the sun can build up even though the outside temperature may not seem too high. It is recommended that the FM band be used where ever possible as better results in terms of quality and freedom from interference will usually be obtained than on the MW or LW bands.



Specifications

Power Requirements

Mains AC 230 volts, 50Hz  only
Batteries 4 x LR14 (C size)

Battery Life

Approx. 80hrs of listening for 4 hours a day at normal volume using alkaline cells.

Frequency Coverage

FM 87.5-108MHz
MW 522- 1620kHz
LW 144- 281kHz

Circuit Features

Loudspeaker	92mm 4ohms
Output Power	1W into 4ohms
Headphone socket	3.5mm dia
Aerial System	FM Telescopic aerial
	MW Built-in Ferrite aerial
	LW Built-in Ferrite aerial

ROBERTS RADIO LIMITED

PO BOX 130
MEXBOROUGH
SOUTH YORKSHIRE
S64 8YT

The Company reserves the right to amend the specification without notice.

Notes:

Guarantee

This instrument is guaranteed for twelve months from the date of delivery to the original owner against failure due to faulty workmanship or component breakdown, subject to the procedure stated below. Should any component or part fail during this guarantee period it will be repaired or replaced free of charge.

The guarantee does not cover:

1. Damage resulting from incorrect use.
2. Consequential damage.
3. Receivers with removed or defaced serial numbers.

N.B. Damaged or broken telescopic aerials will not be replaced under guarantee.

Procedure:

Any claim under this guarantee should be made through the dealer from whom the instrument was purchased. It is likely that your Roberts' dealer will be able to attend to any defect quickly and efficiently, but should it be necessary the dealer will return the instrument to the company's service department for attention. In the event that it is not possible to return the instrument to the Roberts' dealer from whom it was purchased, please contact Roberts Radio Technical Services department at the address shown on the rear of this manual before taking further action.

These statements do not affect the statutory rights of a consumer.

ROBERTS RADIO TECHNICAL SERVICES DEPARTMENT

97-99 Worton Road
Isleworth Middlesex
TW7 6EG

Issue 1

Technical Helpline:- 020 8758 0338 (*Mon-Fri*)



Free Manuals Download Website

<http://myh66.com>

<http://usermanuals.us>

<http://www.somanuals.com>

<http://www.4manuals.cc>

<http://www.manual-lib.com>

<http://www.404manual.com>

<http://www.luxmanual.com>

<http://aubethermostatmanual.com>

Golf course search by state

<http://golfingnear.com>

Email search by domain

<http://emailbydomain.com>

Auto manuals search

<http://auto.somanuals.com>

TV manuals search

<http://tv.somanuals.com>