

ROBERTS

Sound for Generations

R9939

PLL Synthesised 3 band mains battery radio



Please read this manual before use

Contents

Important Information	1
Automatic FM setup	2
Controls	3-4
Display	5
Battery Operation	6
Mains Operation	6
Setting the clock time	7
Setting the alarm time	8
Displaying the alarm time	9
Wake to buzzer	9
Wake to radio	10
Snooze control	10
Operating your radio - search tuning	11
Operating your radio - manual tuning	12
Presetting stations	13
Recalling a preset station	14
Last station memory	14
Sleep timer	15
Display backlight	15
Headphones	15
Troubleshooting	16
General	16

Specifications	17
Circuit features	17
Mains supply	18
Guarantee	back cover

Important Information - please read before use

To assist the auto setup of your radio it is recommended that, before connecting your radio to a power supply (batteries or mains), you fully extend the telescopic aerial and place your radio in a position where radio reception is best.

note : the two LR6 (AA size) batteries provide power for the clock/memory backup and must be fitted at all times.

Automatic FM setup

When your radio is first connected to a power supply (batteries or mains) or after a power failure (when backup batteries are not installed), the **Auto setup** will automatically search the FM waveband and store stations in presets.

1. Install batteries or connect to mains (see page 6). Your radio will show start searching the FM waveband.
2. Your radio will automatically switch off and return to time display when setup is complete. (Setting the clock time is described on page 7)
3. Press the **On/Off button** to switch on your radio and press one of the **Preset buttons** to select a station.
4. Adjust the volume using the **Volume control**. To switch off your radio press the **On/Off button**.

Note:- **Auto setup** can take 3-4 minutes to complete and is dependent on the signal strength and number of stations in your area.

To interrupt the **Auto setup** press and release the **Memo button**.

Should **Auto setup** fail, setting FM pre-setting stations can be carried out manually as described in the following sections.

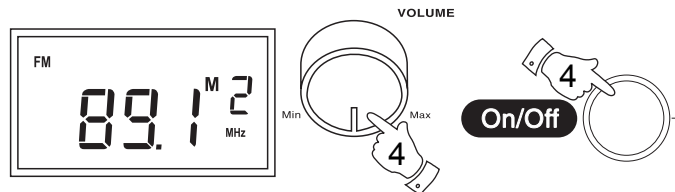
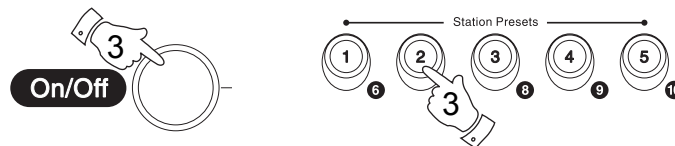
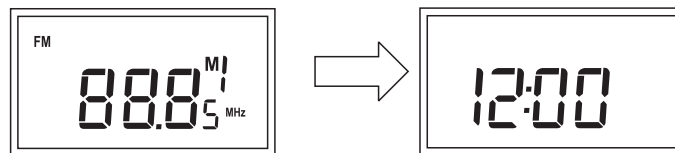
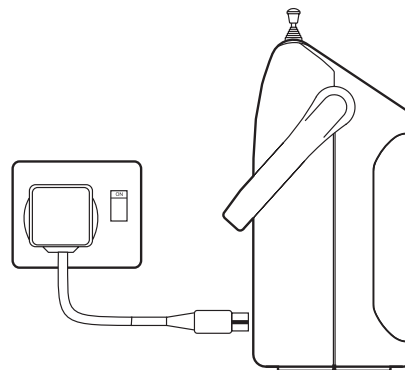

Controls

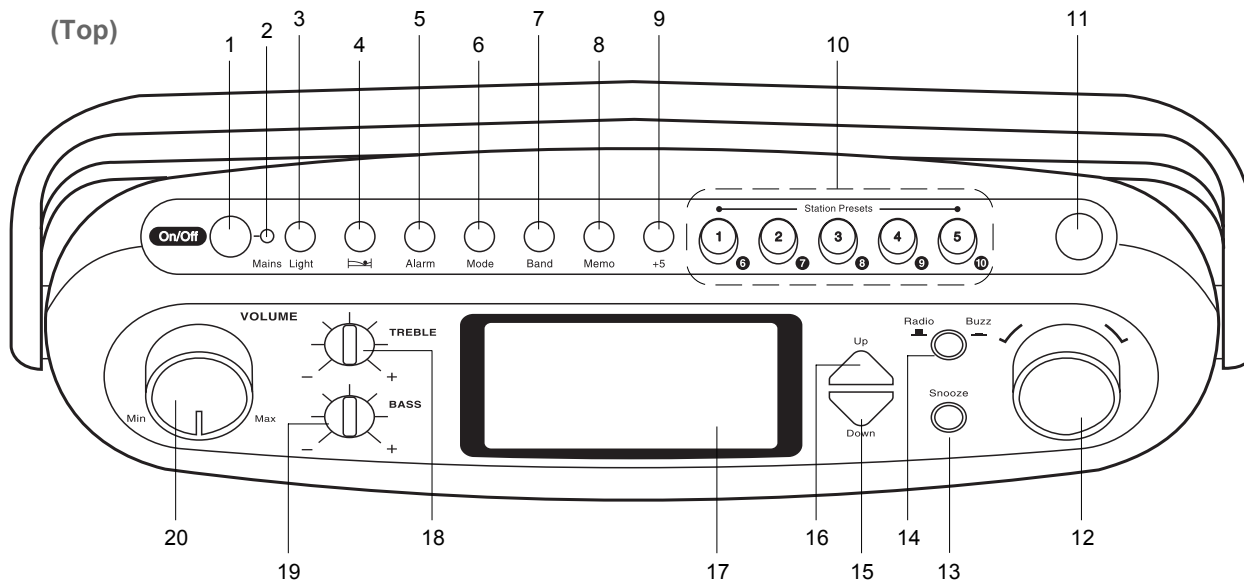

1. On/Off button

2. Mains LED indicator

3. Light button

4. Sleep button

5. Alarm button

6. Mode button

7. Band button

8. Memo button

9. +5 button

10. Preset buttons

11. Telescopic aerial

12. Tuning control

13. Snooze button

14. Alarm mode button

15. Tuning down button

16. Tuning up button

17. Liquid crystal display
(LCD)

18. Treble control

19. Bass control

20. Volume control

Controls

(Rear)

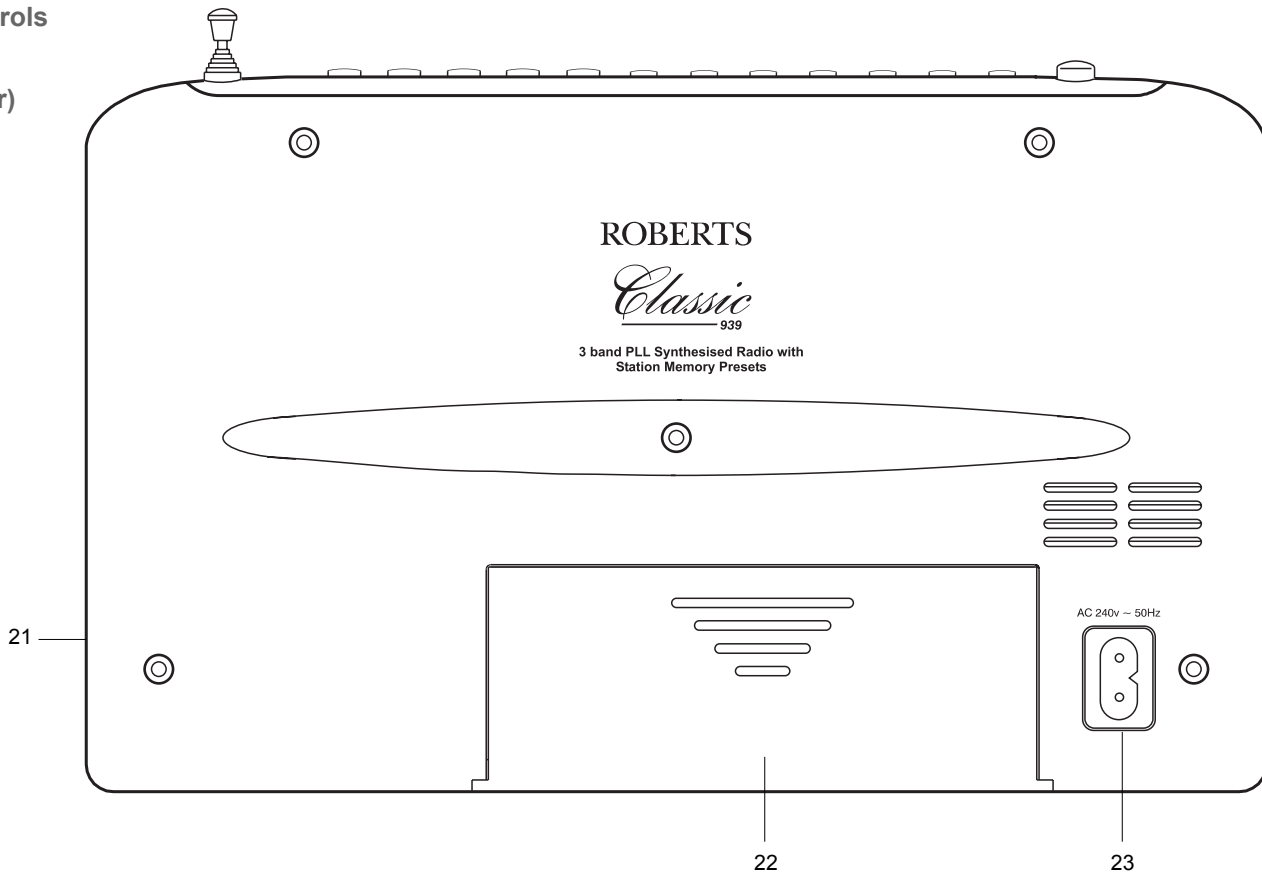

21. Headphone socket (on side)

22. Battery compartment

23. Mains socket

Display

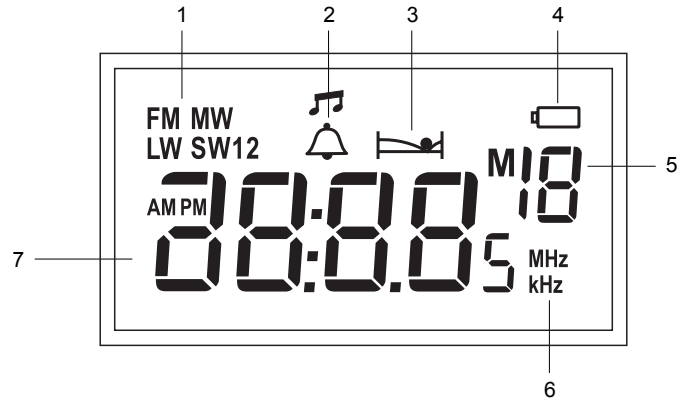

1. Waveband indicators
2. Alarm symbol
3. Sleep time symbol
4. Battery indicator

5. Preset indicator
6. Frequency units
7. Frequency/time digits

Battery operation

1. Remove the **Battery cover** on the rear of the unit by pushing the battery door in and downwards.
2. Insert two LR6 (AA size) batteries into the small spaces under flap with yellow label. Insert four LR14 (C size) batteries into the remaining spaces in the compartment. Take care to ensure all batteries are inserted with the correct polarity as shown inside the battery compartment. Replace the battery cover.

note : the two LR6 (AA size) batteries provide power for the clock/memory backup and must be fitted at all times.

3. Reduced power, distortion and a 'stuttering' sound are all signs that the 4 LR14 batteries may need replacing.
4. If the radio is not to be used for any extended period of time it is recommended that the batteries are removed from the radio.

We would recommend for economy that the R9939 is used on the mains whenever possible with battery operation for occasional or stand-by use only.

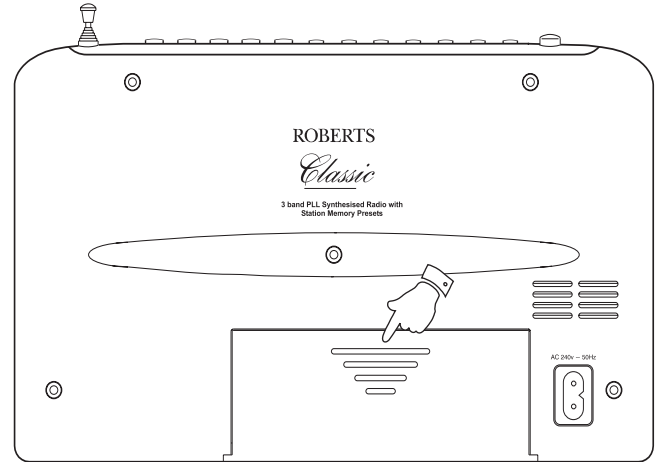

Mains operation

1. Place your radio on a flat surface.
2. Plug the mains lead into the **Socket** located on the rear of your radio ensuring that the plug is pushed fully into the socket.
3. Plug the other end of the mains lead into a wall socket and switch on the wall socket.

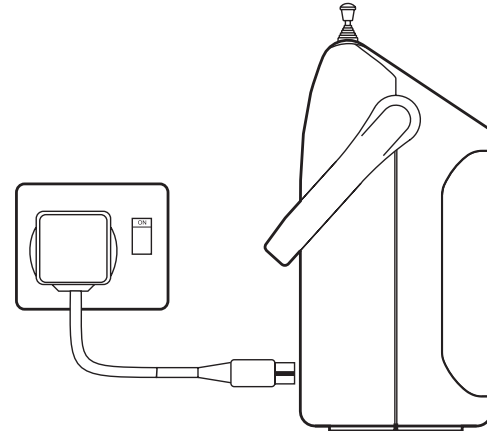

If you need any further advice, please call our Technical Helpline on :-

020 8758 0338 (Mon-Fri)

Download from www.Somanuals.com. All Manuals Search And Download.

Setting the clock time

1. Ensure that you radio is switched off.
2. When first connected to mains or batteries the display will show "12:00"
3. Hold down the **Mode button** until the display begins to flash.
4. Set the hours using the **Down button** or turn **Tuning Control** to the left.
5. Set the minutes using the **Up button** or turn **Tuning control** to the right.
6. Press the **Mode button** to store the time.

Note: The clock uses the 24 hour system e.g. 2:00pm is shown as 14:00

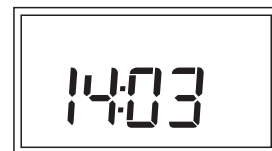
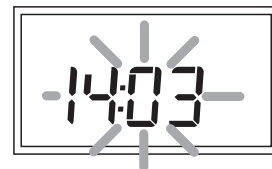
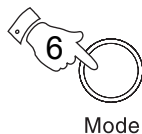
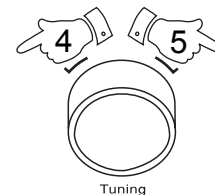
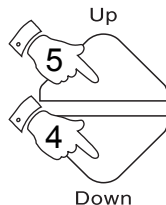
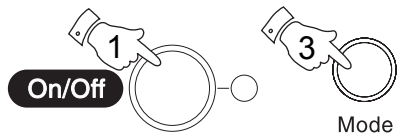

Setting the alarm time

1. Ensure that your radio is switched off.
2. Press and release the **Mode button**. The current alarm time and a flashing alarm symbol will appear in the display.
3. Press and hold down the **Mode button** until the alarm time flashes in the display.
4. Set the hours using the **Down button** or turn **Tuning Control** to the left
5. Set the minutes using the **Up button** or turn **Tuning control** to the right.
6. Press the **Mode button** to store the alarm time.

Note: Setting the alarm time can only be carried out whilst display is flashing (8 seconds).

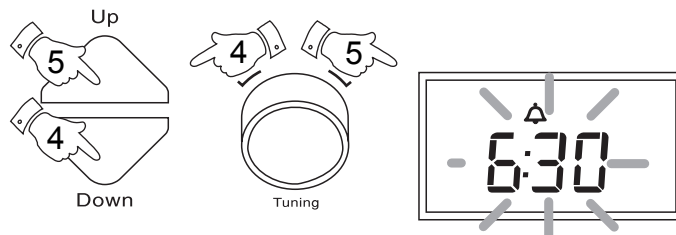
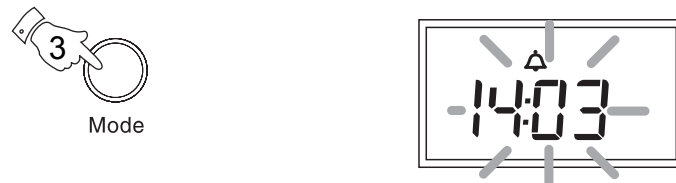
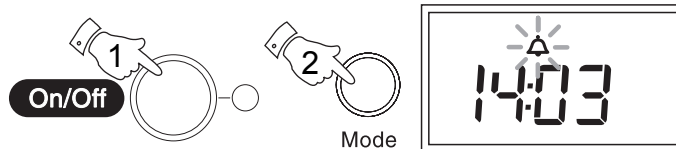



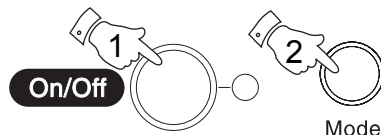

Displaying the alarm time

1. Switch off your radio using the **On/Off button**.
2. Press the **Mode button** once to display alarm time. Clock time will resume automatically after 3 seconds.





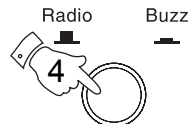
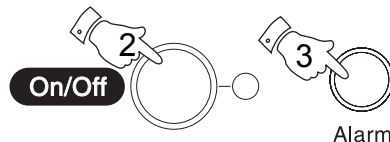

Wake to buzzer

1. Set the alarm time as previously described.
2. Switch off your radio using the **On/Off button**.
3. Press and release the **Alarm button** until either the  or  symbol appears in the display.
4. Press the **Radio/Buzz button** until the  symbol appears in the display.
5. At the preselected time the buzzer will switch on. The buzzer will switch off automatically after 90 minutes. The buzzer alarm may be switched off for 24 hours by pressing the **On/Off button**.
6. To permanently cancel the buzzer alarm repeatedly press and release the **Alarm button** until the  symbol is removed from the display.



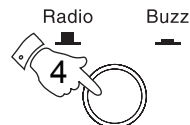
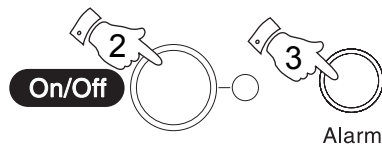

Wake to radio

1. Set the alarm time as previously described.
2. Switch off your radio using the **On/Off button**.
3. Press and release the **Alarm button** until either the  or  symbol appears in the display.
4. Press the **Radio/Buzz button** until the  symbol appears in the display.
5. At the preselected time the radio will switch on. The radio will switch off automatically after 90 minutes. The radio alarm may be switched off for 24 hours by pressing the **On/Off button**.
6. To permanently cancel the radio alarm repeatedly press and release the **Alarm button** until the  symbol is removed from the display.



Snooze control

1. The radio or buzzer alarm can be silenced for 5 minutes by pressing the **Snooze button**. The alarm symbols  or  will flash in the display. This sequence can be repeated during the 90 minutes alarm period.

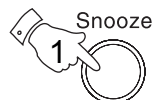

If you need any further advice, please call our Technical Helpline on :-

020 8758 0338 (Mon-Fri)

Download from www.somanuals.com. All Manuals Search And Download.

Operating your radio - search tuning

1. Switch on your radio by pressing the **On/Off button**.
2. Select the required waveband by pressing the **Band button**. The waveband selected will appear in the display. On FM fully extend the **Telescopic aerial**. On MW and LW rotate your radio for best reception.
3. Press and hold down either the **Tuning Up or Down buttons** or turn the **Tuning control** left or right until the frequency in the display begins to change rapidly. Release the button. Your radio will scan the selected waveband, stopping each time it finds a station of sufficient strength.
4. Adjust the **Volume, Bass and Treble controls** to the required settings.
5. To search for additional stations repeat the above procedure. Search tuning may be stopped by a single press on either the **Tuning Up or Down buttons**.
6. Press the **On/Off button** to switch off your radio.

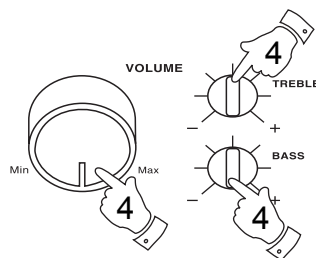
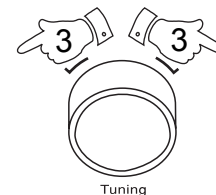
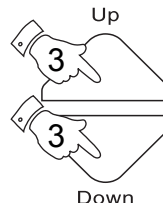
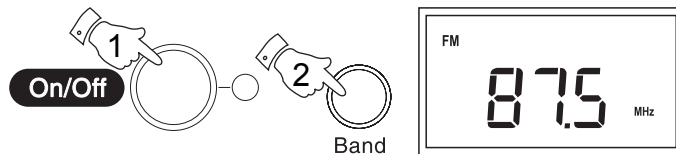

Operating your radio - manual tuning

1. Switch on your radio by pressing the **On/Off button**.
2. Select the required waveband by pressing the **Band button**. The waveband selected will appear in the display. On FM fully extend the **Telescopic aerial**. On MW and LW rotate your radio for best reception.
3. A single press on either the **Tuning + or - buttons** or turn and release the **Tuning control** to change the frequency up or down. The frequency steps are:- FM 50kHz, MW 9kHz and LW 1kHz.
4. Adjust the **Volume, Bass and Treble controls** to the required settings.
5. Press the **On/Off button** to switch off your radio.

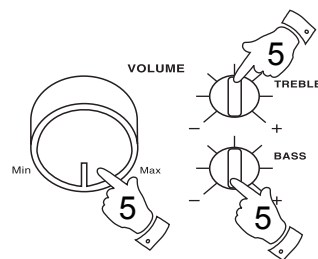
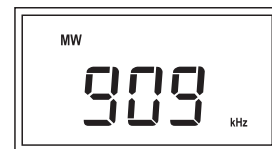
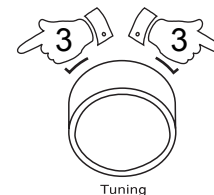
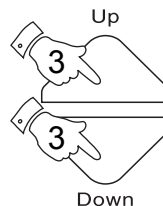
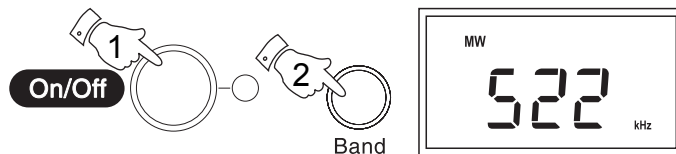

If you need any further advice, please call our Technical Helpline on :-

020 8758 0338 (Mon-Fri)

Download from www.somanuals.com. All Manuals Search And Download.

Pre-setting stations

You may store up to 10 different stations on FM and MW and 5 stations on LW giving a total of 25 preset stations.

1. Switch on your radio using the **On/Off button**.
2. Select the desired waveband using the **Band button**.
3. Tune into the required station using one of the tuning methods previously described.
4. Press and release the **Memo button**, 'M' will flash in the display for 8 seconds.
5. Whilst 'Memory' is flashing press one of the **Preset buttons 1 to 5** under which you wish to store the station.
6. Press the **Memo button** to store the station. The preset number will now appear in the display.
7. On FM and MW Presets 6 to 10 are obtained by pressing **+5** and **Preset button 1 to 5**. e.g preset 7 can be set by pressing **+5** followed by **Preset button 2**
8. Repeat the above procedure for the remaining presets
9. Press the **On/Off button** to switch off your radio.

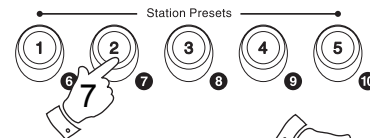
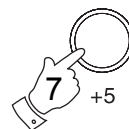
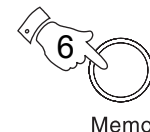
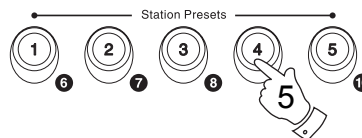
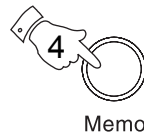
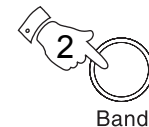

Note: Pre-setting of stations can only be carried out whilst 'M' is flashing in the display (8 seconds).

Recalling a preset station

1. Switch on your radio using the **On/Off button**.
2. Select the desired waveband using the **Band button**.
3. Press one of the **Preset buttons** 1-5 to recall the station.
4. On FM and MW Presets 6 to 10 are obtained by pressing **+5** and **Preset button 1 to 5**. e.g preset 7 can be recalled by pressing **+5** followed by **Preset button 2**.
5. Press the **On/Off button** to switch off your radio.

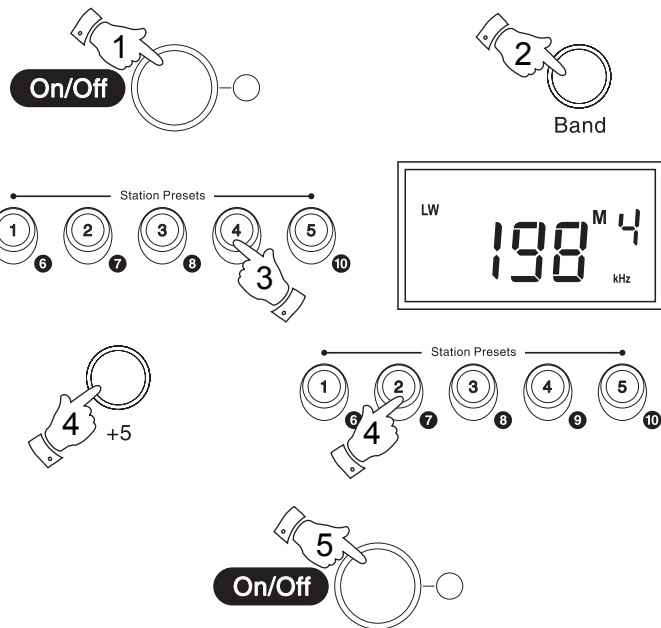

Last station memory

1. Your radio provides an automatic last station memory function. This function recalls the station that was playing when the radio was switched off.

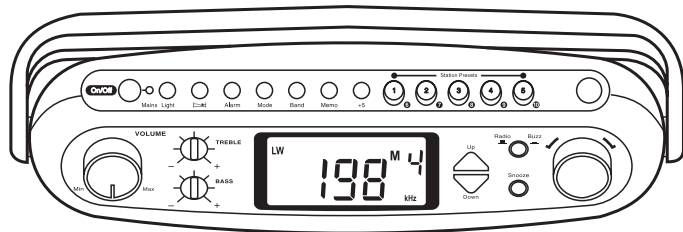

If you need any further advice, please call our Technical Helpline on :-

020 8758 0338 (Mon-Fri)

Download from www.Somanuals.com. All Manuals Search And Download.

Sleep timer

Your radio can be set to turn off after a preset time has elapsed.

1. Press and hold down the  **button** until the desired time is reached (maximum 90 minutes in 10 minute steps). The radio will switch off after the sleep time has elapsed.
2. To cancel the sleep function before the preset time has expired, press the **On/Off button**.

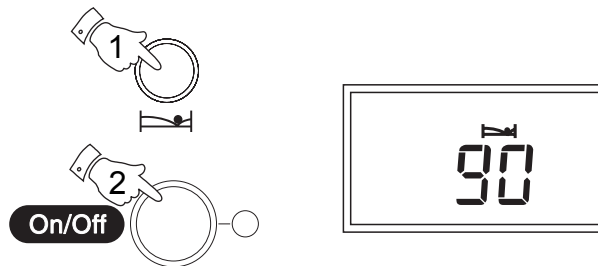

Display backlight

1. The display backlight will be switched on for 8 seconds when the **Light button** is pressed.

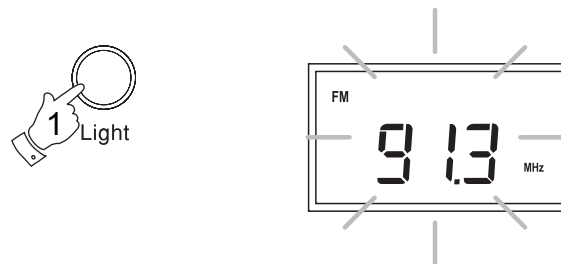

Headphones

1. A **Headphone Socket** (3.5mm) located on the right hand end of your radio is provided for use with either headphones or an earpiece. Inserting the headphone plug automatically mutes the internal loudspeaker.

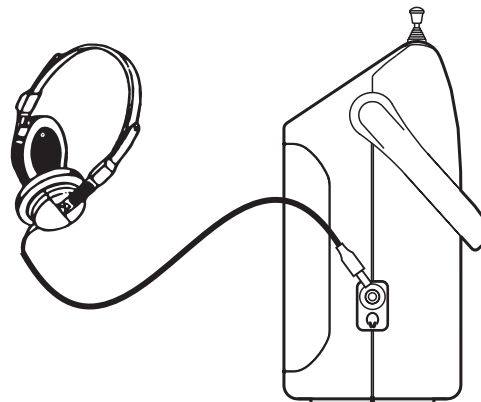

Troubleshooting

Due to external interference (caused by static charges from carpets, thunderstorms, etc.), the control electronics of your radio could receive bad information. If the display is incomplete or the radio is not responding to control buttons, proceed as follows:-

Remove the power supply (the mains and all batteries) and re-install them again after one minute.

This resets the radio to its initial state. The stored data for the individual memory positions, the clock, the alarm settings and the Last Station Memory are all cleared.

General

Do not allow this radio to be exposed to water, steam or sand. Do not leave your radio where excessive heat could cause damage such as in a parked car where the heat from the sun can build up even though the outside temperature may not seem too high. It is recommended that the FM band be used wherever possible as better results in terms of quality and freedom from interference will usually be obtained than on the MW or LW bands.

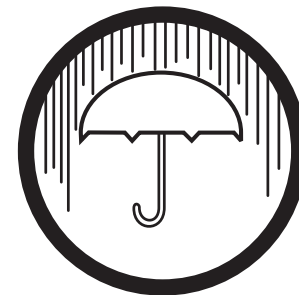
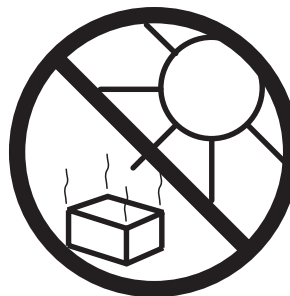

Specifications

Power Requirements

Mains	AC 230 volts, 50Hz  only
Batteries	4 x LR14 (C size) for radio 2 x LR6 (AA size) for clock/memory

Battery Life

Approx. 40hrs of listening for 4 hours a day at normal volume using alkaline cells.

Frequency Coverage

FM	87.5-108MHz
MW	522- 1620kHz
LW	144- 281kHz

Circuit Features

Loudspeaker	92mm 4ohms
Output Power	1W into 4ohms
Headphone socket	3.5mm dia
Aerial System	FM Telescopic aerial MW Built-in Ferrite aerial LW Built-in Ferrite aerial

Mains supply

The R9939 will operate from a supply of AC 230 volts, 50Hz \sim only.

DO NOT cut off the mains plug from this equipment. If the plug fitted is not suitable for the power points in your home or the cable is too short to reach a power point, then obtain an appropriate safety approved extension lead or adaptor. If in doubt consult your dealer.

If nonetheless the mains plug is cut off, remove the fuse and dispose of the plug immediately. This will avoid a possible shock hazard by inadvertent connection to the mains supply.

If this product is not supplied with a mains plug, or one has to be fitted, then follow the instructions given below:

IMPORTANT. DO NOT make any connection to the larger terminal which is marked with the letter E or by the safety earth symbol \perp or coloured Green or Green-and-yellow.

The wires in the mains lead are coloured in accordance with the following codes :-

BLUE - NEUTRAL

BROWN - LIVE

The wire coloured BLUE must be connected to the terminal marked N or coloured BLACK.

The wire coloured BROWN must be connected to the terminal marked L or coloured RED.

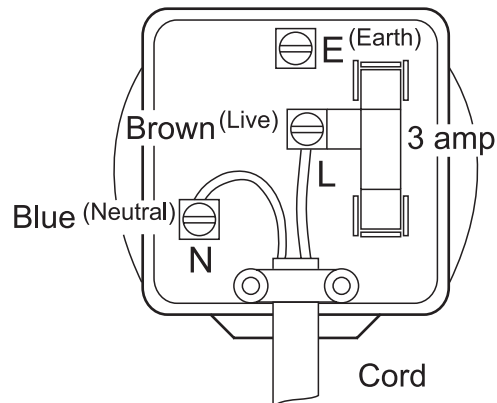

Fuse

When replacing the fuse only a 3A ASTA approved to BS1362 type should be used and be sure to re-fit the fuse cover.

IF IN DOUBT - CONSULT A QUALIFIED ELECTRICIAN.

Replacement fuse holders are available from Roberts Radio Technical Services at the address shown on the rear of this manual.

Guarantee

This instrument is guaranteed for twelve months from the date of delivery to the original owner against failure due to faulty workmanship or component breakdown, subject to the procedure stated below. Should any component or part fail during this guarantee period it will be repaired or replaced free of charge.

The guarantee does not cover:

1. Damage resulting from incorrect use.
2. Consequential damage.
3. Receivers with removed or defaced serial numbers.

N.B. Damaged or broken telescopic aerials will not be replaced under guarantee.

Procedure:

Any claim under this guarantee should be made through the dealer from whom the instrument was purchased. It is likely that your Roberts' dealer will be able to attend to any defect quickly and efficiently, but should it be necessary the dealer will return the instrument to the company's service department for attention. In the event that it is not possible to return the instrument to the Roberts' dealer from whom it was purchased, please contact Roberts Radio Technical Services at the address shown below.

These statements do not affect the statutory rights of a consumer.

ROBERTS RADIO TECHNICAL SERVICES

97-99 Worton Road
Isleworth Middlesex
TW7 6EG

Technical Helpline:- 020 8758 0338 (Mon-Fri)



Free Manuals Download Website

<http://myh66.com>

<http://usermanuals.us>

<http://www.somanuals.com>

<http://www.4manuals.cc>

<http://www.manual-lib.com>

<http://www.404manual.com>

<http://www.luxmanual.com>

<http://aubethermostatmanual.com>

Golf course search by state

<http://golfingnear.com>

Email search by domain

<http://emailbydomain.com>

Auto manuals search

<http://auto.somanuals.com>

TV manuals search

<http://tv.somanuals.com>