

ROBERTS

R9942

FM Stereo PLL Synthesised
Personal Radio

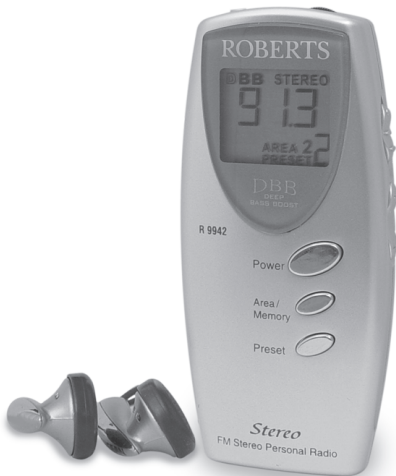

Operating Instructions

Download from [Www.Somanuals.com](http://www.Somanuals.com). All Manuals Search And Download.

Contents

<i>Contents</i>	1
<i>Controls</i>	2
<i>Headphones</i>	5
<i>Display</i>	6
<i>Battery</i>	7
<i>Lock switch</i>	9
<i>Earphones</i>	11
<i>Aerial</i>	11
<i>Auto preset</i>	13
<i>Scan tuning</i>	15
<i>Manual tuning</i>	15
<i>Presetting stations</i>	17
<i>Recalling a preset station</i>	19
<i>Mono mode</i>	21
<i>Dynamic bass boost switch</i>	21
<i>Auto power off</i>	21
<i>DX/Local switch</i>	23
<i>Neck strap</i>	23
<i>Reset button</i>	25
<i>General</i>	25
<i>Specification</i>	26
<i>Guarantee</i>	<i>back cover</i>

Controls

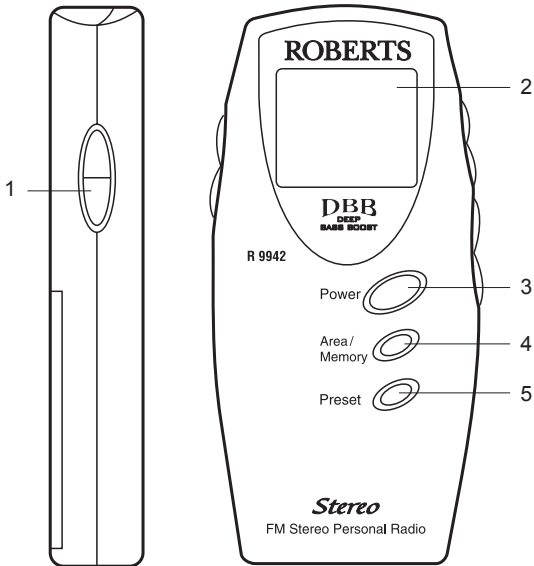

1. DBB/Mono/Stereo switch

2. LCD display

3. Power button

4. Area/Memo button

5. Preset button

Controls

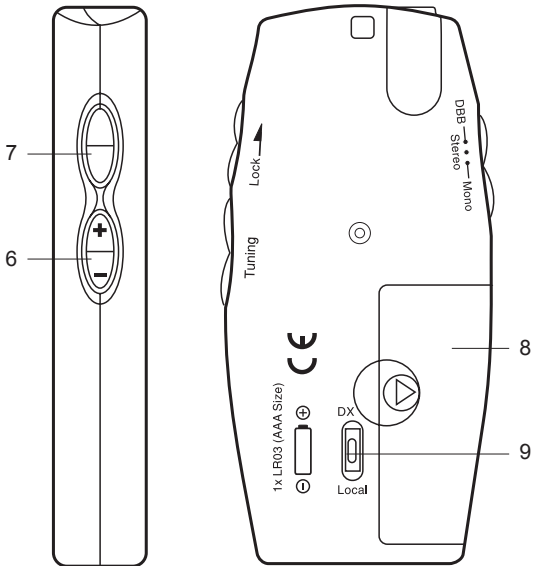

6. Tuning + / - buttons

7. Lock switch

8. Battery compartment

9. DX/Local switch

Controls

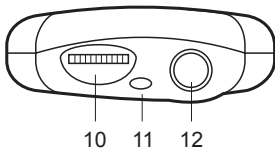

- 10. Volume control
- 11. Neck strap attachment point
- 12. Earphone socket

Headphones

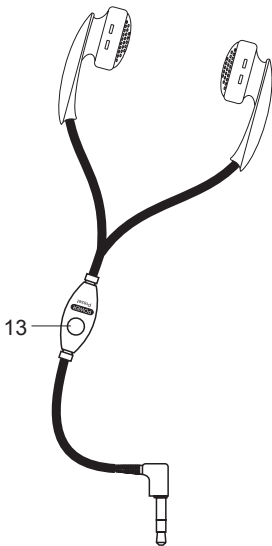

13. Remote button

Display

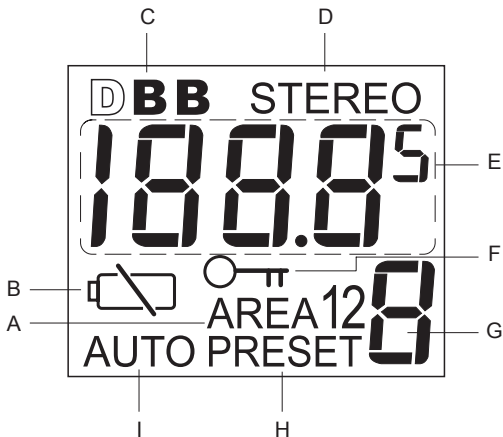

- | | |
|---------------------------------|--------------------------|
| A. Area indicator | F. Lock indicator |
| B. Battery indicator | G. Preset number |
| C. Dynamic bass boost indicator | H. Preset indicator |
| D. Stereo indicator | I. Auto preset indicator |
| E. Frequency indicators | |

Battery

1. Open the battery cover located on the rear of the your radio by sliding it in the direction shown by the arrow.
2. Insert one LR03 (AAA) size battery into the compartment. Ensure that battery is inserted in accordance with the diagram shown on the rear of your radio.
3. Close the battery cover
4. Battery should be replaced when the low battery indicator  appears in the display .
5. During battery replacement ensure that the radio is turned off and the **Lock switch** is in the “Lock” position , this will prevent loss of memory presets during battery replacement .

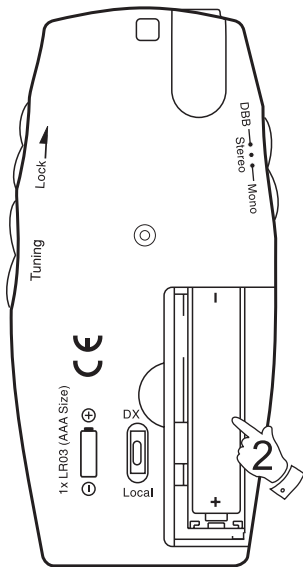
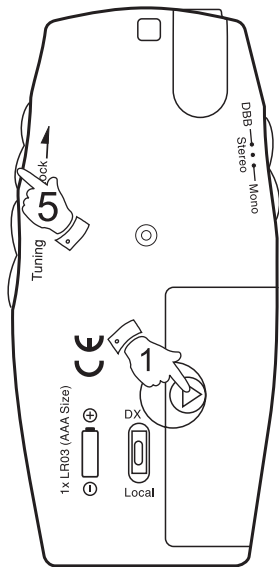

Battery replacement should be completed within one minute to prevent loss of stations stored in memory presets.

6. If the radio is not to be used for a long period , set the **Lock switch** to the “Lock” position , this will reduce power drain on the batteries during storage .
7. Reduced power, distortion and a ‘stuttering’ sound are all signs that the batteries may need replacing.
8. If the radio is not to be used for an extended period of time it is recommended that the battery is removed from the radio.



Lock switch

The Lock switch is used to prevent unintentional operation of your radio.

1. Set the **Lock switch** located on the right side of your radio to the 'Lock' position . The power and all other buttons will be disabled, this will prevent accidental operation when your radio is packed in a suitcase or travel bag .
2. To prevent accidental operation of the controls when your radio is switched on, set the Lock switch to the up 'Lock' position, the  symbol will appear in the display .
3. To release the Lock switch, move the lock switch to the down 'Unlock' position, the  symbol will be removed from the display.

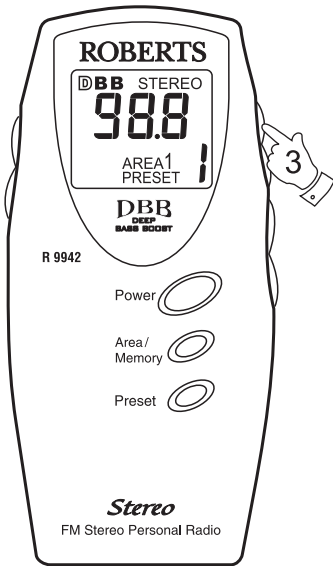
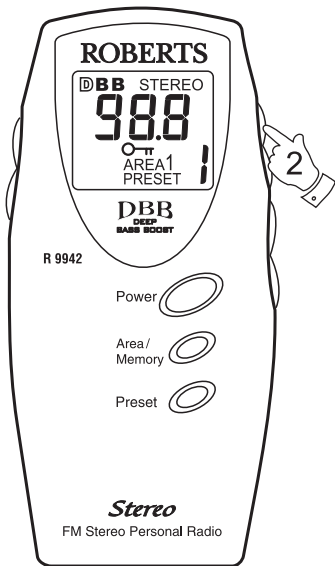

Earphones

Plug the earphones into the **Earphone socket** located on the top of your radio.

Aerials

The lead connecting earphones to your radio acts as an FM aerial when plugged into the **Earphone socket**. The lead should be extended as much as possible to increase reception.

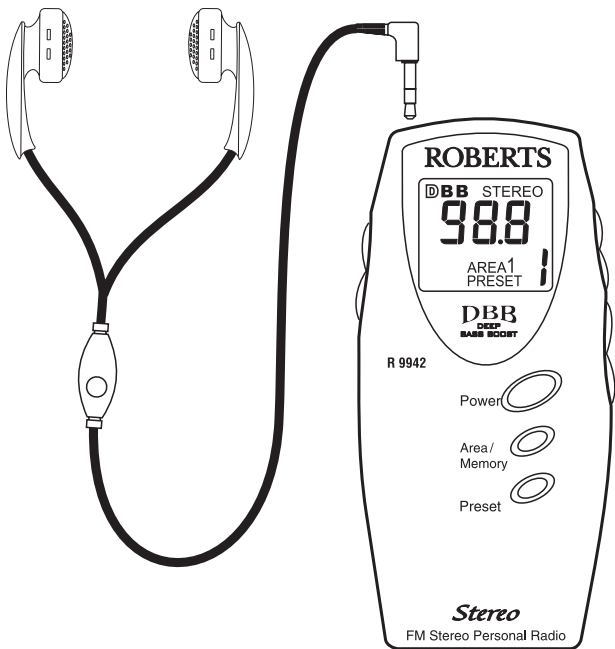

Auto preset

1. When the battery is inserted into the battery compartment for the first time, with earphones plugged in, your radio will quickly and automatically preset stations in order based upon their signal strength. The display will flash AUTO PRESET.

This feature is especially useful for the traveller who can automatically find all the local stations in any city to which he may travel. The radio will switch off automatically after Auto Preset is complete. Up to 9 stations can be stored on Preset AREA 1 .

2. The Auto preset function can also be activated at any time your radio is switched on by holding down both the **Tuning + and - buttons** for more than 2.5 seconds.

Note : *Activating the Auto Preset function will overwrite any stations previously stored in the memory presets .*

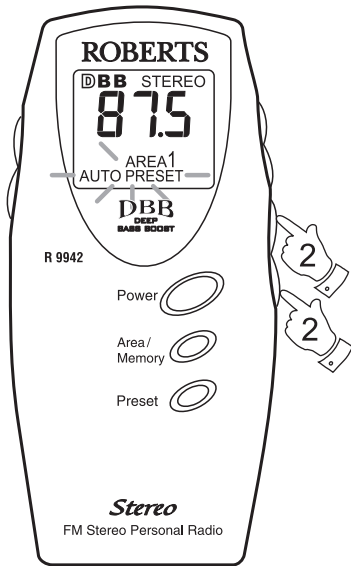

Scan tuning

1. Switch on your radio by pressing the **Power button** or **Remote button** on the earphones for more than 1.5 sec.
2. Press and hold down either the **Tuning + or - buttons** until the frequency in the display begins to change rapidly. Release the button. Your radio will scan the FM band and stop automatically when it finds a station of sufficient strength.
3. Adjust the **Volume control** to the required setting.
4. Press and hold down either the **Tuning + or - buttons** for more than half a second to resume scan tuning.
5. When the waveband end is reached your radio will continue tuning from the opposite waveband end.

Manual tuning

1. Switch on your radio by pressing the **Power button** or **Remote button** on the earphones for more than 1.5 sec.
2. The required station may be selected by repeatedly pressing **either the Tuning + or - buttons**.
3. Adjust the **Volume control** to the required setting.
4. When the waveband end is reached your radio will continue tuning from the opposite waveband end.

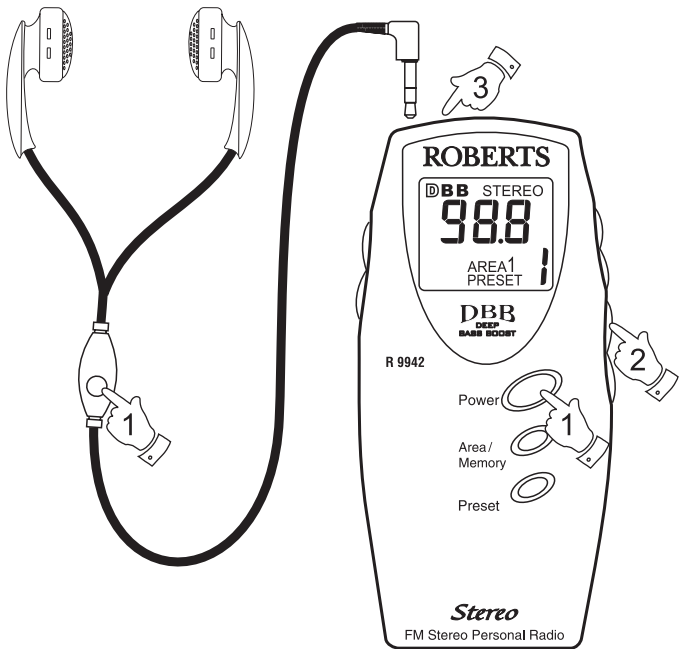

Presetting stations

Your radio is equipped with 2 area memories. There are 9 preset memories on each area giving a total of 18 preset memories.

1. Switch on your radio and tune into the required station using one of the tuning methods previously described.
2. Press the **Area/Memo button**, the display will flash PRESET
3. Repeatedly press **Preset button** to select the required memory preset.
4. Press the **Area/Memo button** to complete setting of the memory preset .
5. Repeat the above for remaining 8 presets.
6. To change Preset area from Area 1 to Area 2 and vice versa, press and hold down the **Area/Memo button** for more than 3 seconds, display will flash AREA, continue holding down the **Area/Memo button** for another 2 seconds until flashing stops. The Preset area now is changed from Area 1 to Area 2.
7. A further 9 stations may now be preset in memory Area 2.

Note: *Favourite stations for your home location could be stored in preset Area 1. Preset Area 2 could be used for stations found when travelling to new cities. Stations can be preset using the Auto preset function as previously described. Previously stored presets are overwritten when using the Auto preset function.*

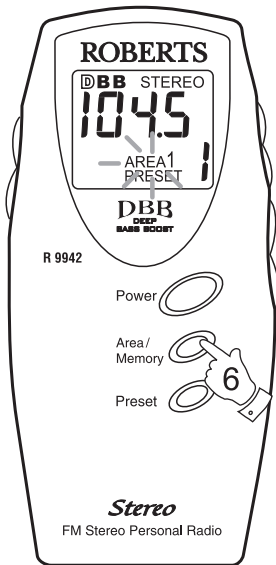
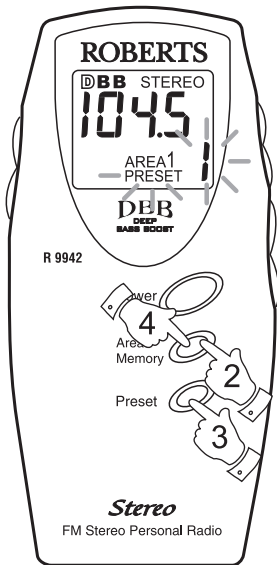

Recalling a preset station

Your radio is equipped with 2 Area memories there are 9 preset memories on each area giving a total of 18 preset memories.

1. Switch on your radio and select the required preset area.
2. Repeatedly press and release the **Preset button**, to select the required preset
3. Presets may also be selected by repeat pressing of the **Remote button** on the earphones.

Note: *Pressing the remote button on the earphones for more than 1.5 seconds will switch off your radio.*

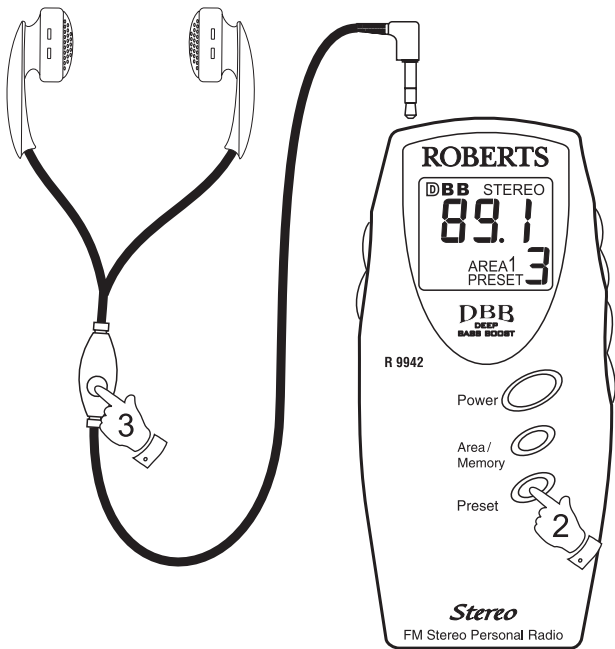

Mono mode

1. If a station being received is weak some hiss may be audible. To reduce the hiss slide the **DBB/Stereo/Mono button** to the “Mono“ position. The stereo indicator will be removed from the display.

Dynamic Bass Boost switch

1. Setting the **DBB/Stereo/Mono button** to the DBB position will enhance bass sounds. The display will show **D B B**.

Auto power off

1. In order to save battery power, your radio is designed to automatically switch off after 90 minutes of use . Disconnecting the earphones from earphones socket for more 10 seconds will also switch off the power automatically.

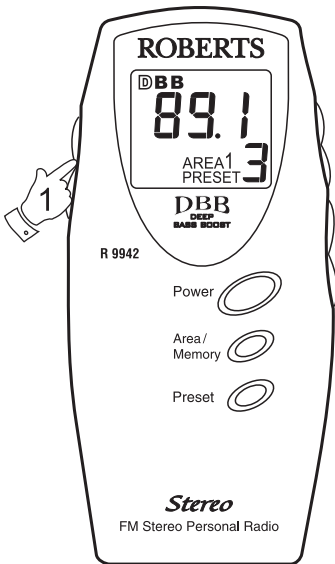

DX/Local switch

The **"DX/Local"** switch adjusts the radios sensitivity.

1. If you are listening to a strong station and the signal is distorted, set the **"DX/Local"** switch to the **'Local'** position. For normal or weak stations set the **'DX/Local'** switch to the **'DX'** position for maximum sensitivity.

Neck strap

A neck strap is provided to enable your radio to be worn around your neck.

1. Attach the neck strap by passing the small loop through the slot in cabinet top.
2. Pass the large loop through small loop to complete attachment of the neck strap.

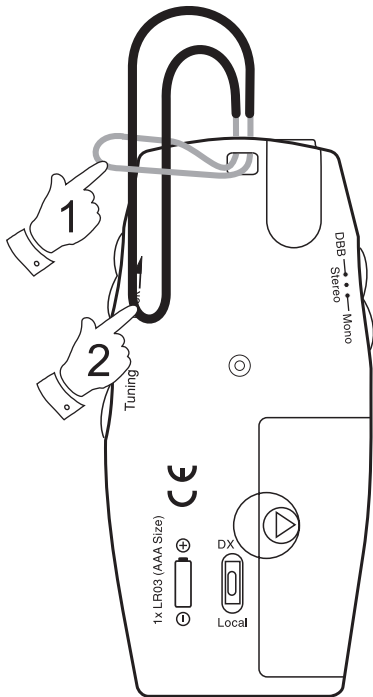
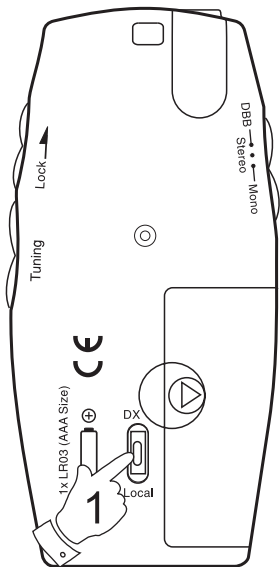

Reset button

If the radio fails to operate correctly or some digits on the display are missing or incomplete, carry out the following procedure.

1. Switch off the radio.
2. With the aid of a suitable implement (the end of a paper clip or pen), press the RESET button located in the bottom of the radio for at least 5 seconds. This will reset the microprocessor and clear all stations stored in the preset memories.

General

Do not allow this unit to be exposed to moisture e.g. dripping or splashing. Do not leave your radio where excessive heat could cause damage such as in a parked car where the heat from the sun can build up even though the outside temperature may not seem too high.

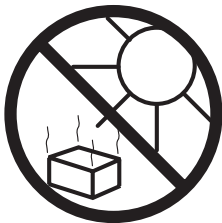

Specifications

Battery	1 x LR03 (AAA size)
Battery Life	Approx. 30hrs using alkaline battery
Frequency coverage	FM 87.5 - 108MHz
Semiconductors	1 LSI, 3 IC, 8 transistors, 4 diodes
Output Power	0.5mW
Earphone Jack	3.5mm dia (Stereo)

The company reserves the right to amend the specification without notice

Guarantee

This radio is guaranteed for twelve months from the date of delivery to the original owner against failure due to faulty workmanship or component breakdown, subject to the procedure stated below. Should any component or part fail during this guarantee period it will be repaired or replaced free of charge.

The guarantee does not cover:

1. Damage resulting from incorrect use.
2. Consequential damage.
3. Product with removed or defaced serial numbers.

Procedure: Any claim under this guarantee should be made through the dealer from whom the instrument was purchased. It is likely that your Roberts' dealer will be able to attend to any defect quickly and efficiently but should it be necessary the dealer will return the instrument to the company's service department for attention. In the event that it is not possible to return the instrument to the Roberts' dealer from whom it was purchased, please contact Roberts Radio Technical Services at the address shown below before taking further action.

These statements do not affect the statutory rights of a consumer.

ROBERTS RADIO TECHNICAL SERVICES

97-99 WORTON ROAD
ISLEWORTH MIDDLESEX
TW7 6EG

Free Manuals Download Website

<http://myh66.com>

<http://usermanuals.us>

<http://www.somanuals.com>

<http://www.4manuals.cc>

<http://www.manual-lib.com>

<http://www.404manual.com>

<http://www.luxmanual.com>

<http://aubethermostatmanual.com>

Golf course search by state

<http://golfingnear.com>

Email search by domain

<http://emailbydomain.com>

Auto manuals search

<http://auto.somanuals.com>

TV manuals search

<http://tv.somanuals.com>