

ROBERTS

Sound for Generations

RD-46

FM RDS/DAB digital radio

Gemini 46



DAB
Digital Audio Broadcasting

Please read this manual before use

Contents

<i>Controls</i>	2-3	<i>Headphone socket</i>	17
<i>Battery operation</i>	4	<i>Display backlight</i>	17
<i>Using the AC adaptor</i>	5	<i>General</i>	18
<i>Operating your radio - DAB</i>	6	<i>Specifications</i>	18
<i>Selecting a station - DAB</i>	7	<i>Circuit features</i>	18
<i>Secondary services - DAB</i>	7	<i>Guarantee</i>	19
<i>Display modes - DAB</i>	8		
<i>Finding new stations - DAB</i>	9		
<i>Signal strength display - DAB</i>	9		
<i>Manual tuning - DAB</i>	10		
<i>Autoselect - DAB</i>	10		
<i>Dynamic range control - DAB</i>	11		
<i>Operating your radio - FM</i>	12		
<i>Manual tuning - FM</i>	13		
<i>Display modes - FM</i>	14		
<i>Software version</i>	15		
<i>Presetting stations</i>	15		
<i>Recalling a preset</i>	16		
<i>System reset</i>	16		

Controls

(Front)

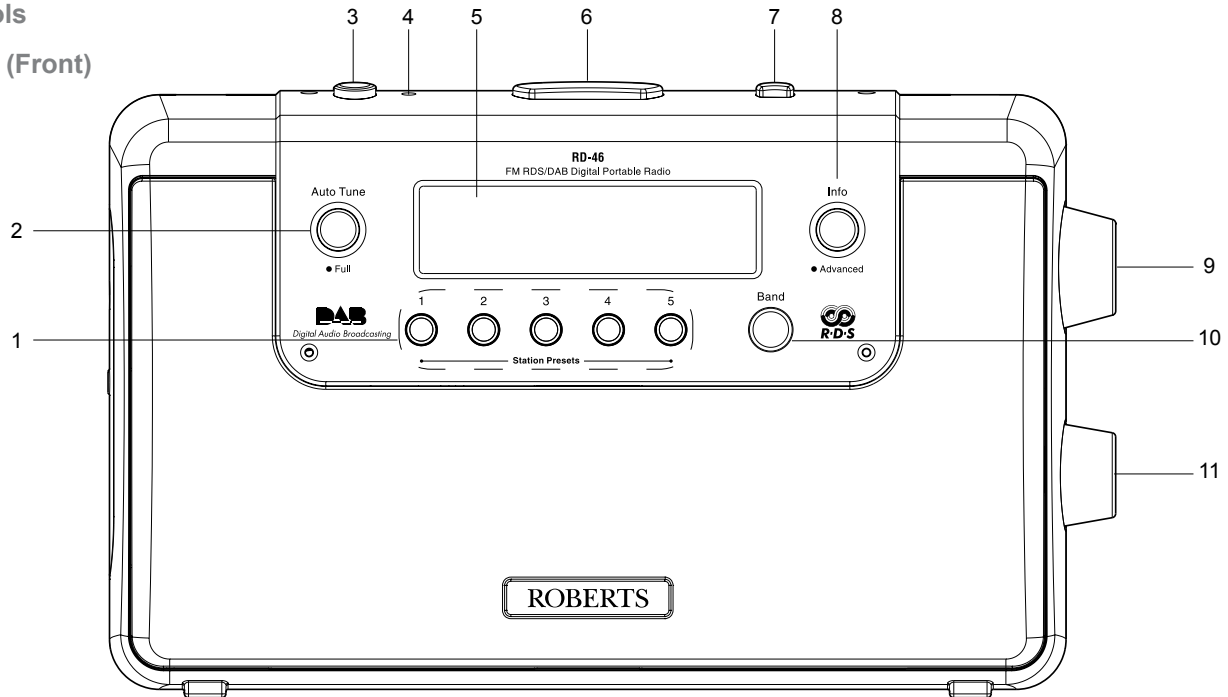

- | | |
|--------------------------|-------------------|
| 1. Preset buttons | 7. Select button |
| 2. Auto Tune button | 8. Info button |
| 3. On/Off button | 9. Volume control |
| 4. On/Off indicator | 10. Band button |
| 5. LCD display | 11. Tone control |
| 6. Tuning Up/Down button | |

Controls
(Back)

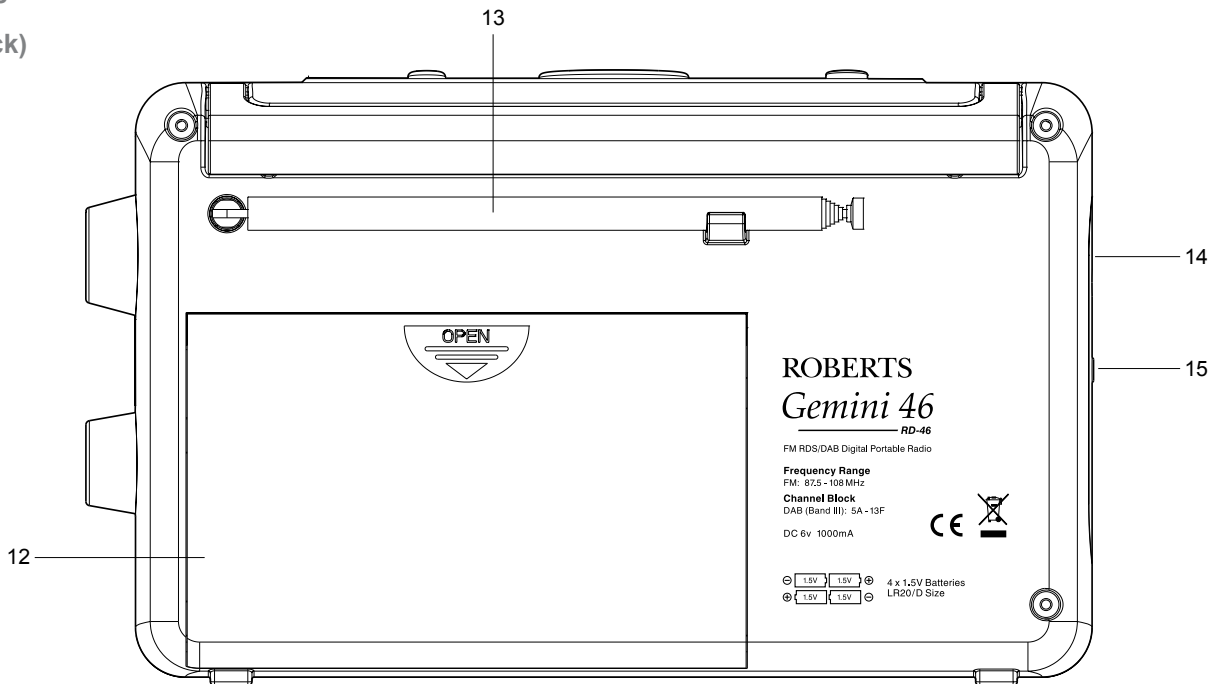

12. Battery compartment

13. Telescopic aerial

14. Headphone socket

15. DC jack socket

Battery operation

1. Remove the battery cover on the back of the unit by sliding the cover in the direction of the arrow.
2. Insert four LR20 (D size) batteries into the spaces in the compartment. Take care to ensure all batteries are inserted with the correct polarity as shown inside the battery compartment. Replace the battery cover.
3. Reduced power, distortion and a 'stuttering' sound are all signs that the batteries may need replacing.
4. If the radio is not to be used for any extended period of time it is recommended that the batteries are removed from the radio.

We would recommend for economy that the RD-46 is used via the AC adaptor whenever possible with battery operation for occasional or stand-by use only.

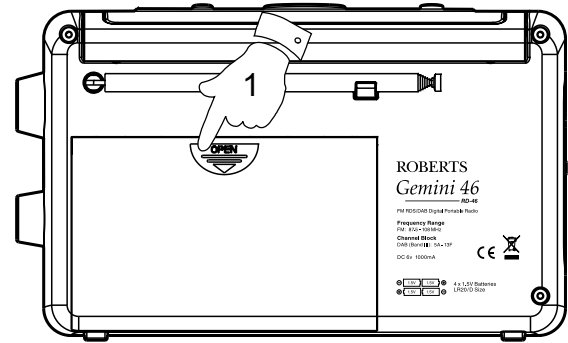

Using the AC adaptor

The AC adaptor for use with the RD46 should provide 6 volts DC output at 1000mA centre pin positive.

1. Insert the adaptor plug into the DC in socket on the left hand side of your radio.
2. Plug the adaptor into a standard 13A mains socket outlet. Whenever the adaptor is used the batteries are automatically disconnected.

The AC adaptor should be disconnected from the mains supply and the radio when not in use.

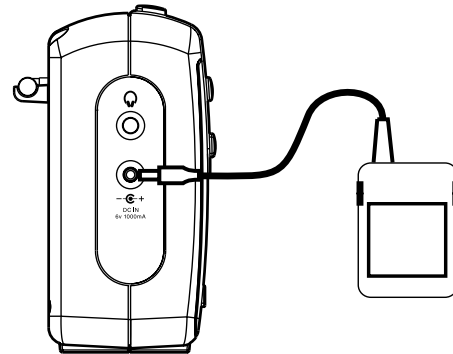

Operating your radio - DAB

1. Carefully extend the telescopic aerial.
2. Press the **On/Off button** to switch on your radio. The **On/Off indicator** will light and the display will show "Roberts" for a few seconds.
3. If this is the first time the radio is used a quick scan of UK Band III DAB channels will be carried out. The display will show "Autotune Quick scan". If the radio has been used before the last used station will be selected.
4. During Autotune as new stations are detected the station counter on the right hand side of the display will increase and stations will be added to the list.
5. When the Autotune is completed the first station (in numeric-alpha order 0...9...A...Z) will be selected.
6. If the station list is still empty after the Autotune your radio will display "No Signal".
7. If no signals are found it may be necessary to relocate your radio to a position giving better reception.



Roberts

Autotune
Quick scan

■■■□□□□□□□□□ 24
Searchin9...

1Xtra
Tuning...

No Signal

Selecting a station - DAB

1. The top line of the display shows the name of the station currently selected.
2. Press the **Tuning Up/Down buttons** to scroll through the list of available stations.
3. Press and release the **Select button** to select the station. The display may show "Tuning" while your radio finds the new station.
4. Adjust the **Volume and tone control** to the required setting.

Note: If after selecting a station the display shows "Not Available" it may be necessary to relocate your radio to a position giving better reception.

Classic

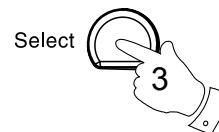
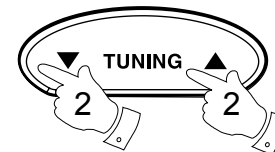

Classic

◆ BBC 7 ◆

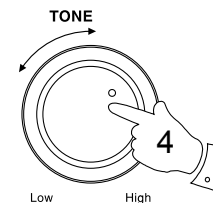
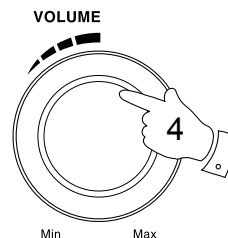

Secondary services - DAB

1. Certain radio stations have one or more secondary services associated with them. If a station has a secondary service associated with it the display will show ">>" next to the station name on the station list. The secondary service will then appear immediately after the primary service as you press the Tuning Up button.
2. Press the **Select button** to select the station.

BBC Radio 5

◆ BBC 5 Live >> ◆

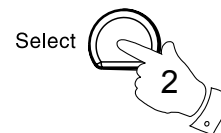

BBC Radio 5

◆ << BBC Sport ◆

Display modes - DAB

Your radio has six display modes:-

1. Press and release the **Info** button to cycle through the various modes.

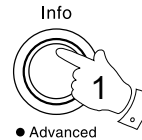

- | | |
|----------------------------|---|
| a. Scrolling text | Displays scrolling text messages such as artist/track name, phone in number, etc. |
| b. Programme type | Displays type of station being listened to e.g. Pop, Classic, News, etc. |
| c. Multiplex name | Displays name of multiplex to which current station belongs. |
| d. Signal strength | Displays signal strength for station being listened to. |
| e. Time and date | Displays current time and date. |
| f. Audio type and bit rate | Displays audio type and bit rate. |

a
BBC 7
Just a Minute...

b
BBC 7
Culture

c
BBC 7
BBC National

d
BBC 7
■■■■■□■■■■

e
BBC 7
19:17 08-06-2006

f
BBC 7
Stereo J128kbps

Finding new stations - DAB

As time passes new stations may become available. To find new stations proceed as follows:-

1. Press and release the **Auto Tune button**, the display will show "Auto tune Quick scan". Your radio will perform a scan of the UK DAB frequencies. As new stations are found the station counter on the right-hand side of the display will increase and stations will be added to the list.
2. To carry out a full scan of the entire DAB Band III frequencies press and hold down the **Auto Tune button** for more than 2 seconds and then release. The display will show "Auto tune Full scan". As new stations are found the station counter on the right-hand side of the display will increase and stations will be added to the list.

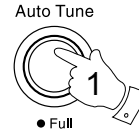

Autotune
Quick scan

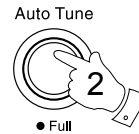

■■■■■■■■■■■■■■■■■■■■ 24
Searching...

Autotune
Full scan...

Signal strength display - DAB

1. Press and release the **Select button** until the display will show signal strength.
2. Position your radio and carefully angle the telescopic aerial for best reception using the signal strength display as a guide. Move your radio around and position so as to give maximum number of black rectangles on signal strength display. The clear unfilled rectangle indicates minimum signal level required for satisfactory reception.
3. Press the **Select button** to exit the signal strength display.

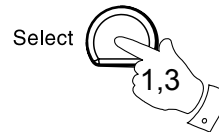

BBC 7
■■■■■□■■■■■

Manual Tuning - DAB

Manual tuning allows you to tune directly to the various DAB Band III channels. UK DAB stations located in the range 11B to 12D.

1. Press and hold the **Select button** until the display shows "Manual tune". Release the **Select button**.
2. Press either the **Tuning Up/Down buttons** to select the required DAB channel.
3. Press and release the **Select button** to select the required DAB channel. The open bar in the middle shows you the minimum signal strength needed for good DAB reception. The signal strength bars will go up and down showing the changing signal strength as you adjust the telescopic aerial on your radio.
4. When a DAB signal is found, the display will show the name of the DAB multiplex. Any new radio stations found will be added to the list stored in the radio.
5. Press and release the **Select button** to return to normal tuning.

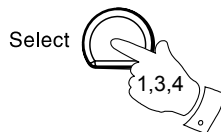

Manual tune

12B 225.648 MHz

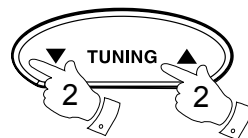

12B 225.648 MHz

BBC 7
Just a Minute...

Autoselect - DAB

As an alternative to pressing the **Select button** to select a station your radio can be set so as to automatically select a station.

1. Press and release either the **Tuning Up or Down buttons** a few times, immediately press and hold down the **Select button** until the display shows "Autoselect ON".
2. Press the **Tuning buttons** until the station you require is visible on the display. After a few seconds your radio will automatically select the station shown on the display.
3. To switch off autoselect press and release the **Tuning Up or Down buttons** a few times, immediately press and hold down the **Select button** until the display shows "Autoselect Off".

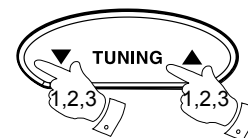

Autoselect ON

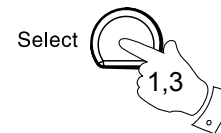

Autoselect OFF

Dynamic Range Control (DRC) settings - DAB

DRC can make quieter sounds easier to hear when your radio is used in a noisy environment.

1. Press the **On/Off** button to switch on your radio.
2. Press and hold in the **Info** button the display will show "Software."
3. Press the **Tuning Up/Down** buttons until the display shows "DRC value".
4. Press and release the **Select** button to enter adjustment mode.
5. Press the **Tuning Up/Down** buttons to select required DRC setting (default is 0) .
DRC 0 DRC is switched off, Broadcast DRC will be ignored.
DRC 1/2 DRC level is set to 1/2 that sent by broadcaster.
DRC 1 DRC is set as sent by broadcaster.
6. Press and release the **Select** button to confirm the setting. The display will return to normal tuning mode.

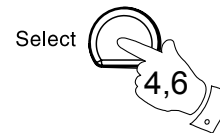
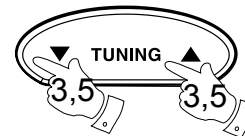
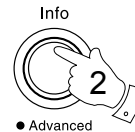

Software v1.35.2
◆Sw version◆

◆◆ or Select
◆DRC value◆

DRC0
◆DRC0◆

DRC0
◆DRC 1/2◆

DRC0
◆DRC 1◆

Operating your radio - FM

1. Carefully extend the telescopic aerial.
2. Press the **On/Off button** to switch on your radio. The display will show "Roberts" for a few seconds.
3. Press the **Band button** to select the FM band.
4. Press and release the **Select button** until the display shows "Auto tune <>".
5. Press the **Tuning Up button** your radio will scan in an upwards direction (low frequency to high frequency) and stop automatically when it finds a station of sufficient strength.
6. After a few seconds the display will update and show station name.
7. Press the **Tuning Down button** to scan the FM band in a downwards direction (high frequency to low frequency).
8. When the waveband end is reached your radio will recommence tuning from the opposite waveband end.
9. Adjust the **Volume and tone control** to the required setting.
10. To switch off your radio press the **On/Off button**.



On/Off

Band

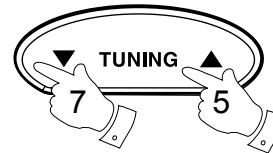
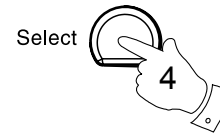

89.30 MHz FM

89.30 MHz FM
Autotune <>

Searching... >

Searching... <

Manual tuning - FM

1. Press the **On/Off button** to switch on your radio.
2. Press the **Band button** to select the FM band. Fully extend the **Tel-escopic aerial**.
3. Press and release the **Select button** until the display shows "Manual tune <>".
4. Press either the **Tuning Up or Down buttons** to tune to a station. The frequency will change in steps of 50kHz.
5. When the waveband end is reached the radio will recommence tuning from the opposite waveband end.
6. Set the **Volume and tone controls** to the required setting.
7. To switch off your radio press the **On/Off button**.

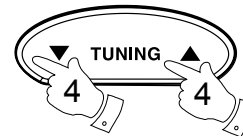
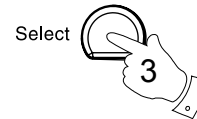
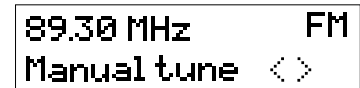
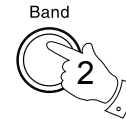
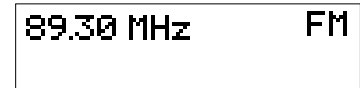

Display modes - FM

On FM the bottom line of the display can be set to any of the following modes:-

1. Press the **Info button** to cycle through the various modes.

- | | |
|---------------------------|--|
| a. Scrolling text | Displays scrolling text messages such as artist/track name, phone in number etc. |
| b. Program Type | Displays type of station being listened to e.g. Pop, Classic, News, etc. |
| c. Time and date | Displays current time and date. |
| d. Frequency & audio mode | Displays frequency of the station being listened to and displays the audio mode, Auto (stereo) or mono |

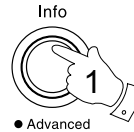

- | | | | | | |
|------------------|---|--------|-------|------------------|--|
| a | <table border="1"><tr><td>BBC R2</td><td>FM</td></tr><tr><td colspan="2">The latest news</td></tr></table> | BBC R2 | FM | The latest news | |
| BBC R2 | FM | | | | |
| The latest news | | | | | |
| b | <table border="1"><tr><td>BBC R2</td><td>FM</td></tr><tr><td colspan="2">Pop Music</td></tr></table> | BBC R2 | FM | Pop Music | |
| BBC R2 | FM | | | | |
| Pop Music | | | | | |
| c | <table border="1"><tr><td>BBC R2</td><td>FM</td></tr><tr><td colspan="2">12:02 16-06-2003</td></tr></table> | BBC R2 | FM | 12:02 16-06-2003 | |
| BBC R2 | FM | | | | |
| 12:02 16-06-2003 | | | | | |
| d | <table border="1"><tr><td>BBC R2</td><td>st FM</td></tr><tr><td colspan="2">88.10MHz</td></tr></table> | BBC R2 | st FM | 88.10MHz | |
| BBC R2 | st FM | | | | |
| 88.10MHz | | | | | |

Software version

The software display cannot be altered and is just for your reference.

1. Ensure the DAB waveband is selected. To view the software version on the display press and hold in the **Info button** the display will show "Software."
2. After a few seconds the display will revert to normal tuning mode.

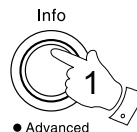

```
Software v1.35.2
◆Sw version◆
```

Presetting stations

There are 5 memory presets for each of the two wavebands.

1. Press the **On/Off button** to switch on your radio.
2. Tune to the required station as previously described.
3. Press and hold the required **Preset button** until the display shows e.g. Preset 1 saved. The station will be stored under the chosen preset button. Repeat this procedure for the remaining presets.
4. Stations stored in the memories may be overwritten by following the above procedure.

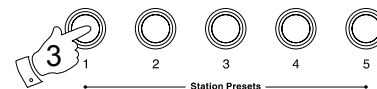

```
BBC R2
Preset 1 saved
```

Recalling a preset

1. Press the **On/Off button** to switch on your radio.
2. Select the required waveband.
3. Momentarily press the required **Preset button**, your radio will tune to the station stored in preset memory.

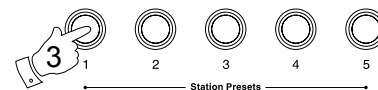

BBC 7
Just a Minute...

System reset

If your radio fails to operate correctly, or some digits on the display are missing or incomplete carry out the following procedure.

1. Press and hold down the **Info button** for 2 seconds "Software" will be displayed.
2. Press the **Tuning Up/Down buttons** until the display shows "or SELECT Factory reset".
3. Press in and release the **Select button** to select System reset.
4. Press the **Select button**, a full reset will be performed. All presets and station lists will be erased.
5. After a system reset a scan of the DAB band will be performed.
In case of malfunction due to electrostatic discharge, reset the product (reconnection of power source may be required) to resume normal operation.

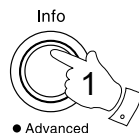

Software v1.35.2
◆Sw version◆

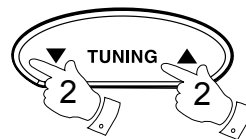

◆◆ or Select
◆Factory reset◆

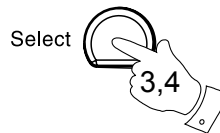

Press SELECT to
confirm reset...

Autotune
Quick scan

Headphone socket

A 3.5mm **Headphone Socket** located on the left hand side of your radio is provided for use with either headphones or an earpiece. Inserting a plug automatically mutes the internal loudspeaker.



Display backlight

1. When using on batteries, the display backlight will be switched on for approximately 12 seconds when any button is pressed.
2. When your radio is powered by AC mains the display backlight will always be switched on.

General

Do not allow this radio to be exposed to water, steam or sand. Do not leave your radio where excessive heat could cause damage such as in a parked car where the heat from the sun can build up even though the outside temperature may not seem too high. It is recommended that the DAB band be used wherever possible as better results in terms of quality and freedom from interference will usually be obtained than on the FM band.

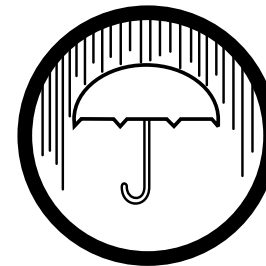
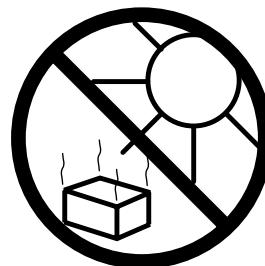

The name plate is located on the back of your radio.

Specifications

Power Requirements

Mains AC 230 volts, 50Hz \sim only (adaptor)
Batteries 4 x LR20 (D size)

Battery Life

Approx. 80 hours of listening for 4 hours a day at normal volume using alkaline cells.

Frequency Coverage

FM 87.5-108MHz
DAB 174.928 - 239.200MHz

Circuit Features

Loudspeaker 75mm

Headphone socket 3.5mm dia

Aerial System FM Telescopic aerial

DAB Telescopic aerial

The Company reserves the right to amend the specification without notice

If you need any further advice, please call our Technical Helpline on :-

020 8758 0338 (Mon-Fri)

Download from www.Somanuals.com. All Manuals Search And Download.

Guarantee

This instrument is guaranteed for twelve months from the date of delivery to the original owner against failure due to faulty workmanship or component breakdown, subject to the procedure stated below. Should any component or part fail during this guarantee period it will be repaired or replaced free of charge.

The guarantee does not cover:

1. Damage resulting from incorrect use.
2. Consequential damage.
3. Receivers with removed or defaced serial numbers.

N.B. Damaged or broken telescopic aerials will not be replaced under guarantee.

Procedure:

Any claim under this guarantee should be made through the dealer from whom the instrument was purchased. It is likely that your Roberts' dealer will be able to attend to any defect quickly and efficiently but should it be necessary the dealer will return the instrument to the Company's service department for attention. In the event that it is not possible to return the instrument to the Roberts' dealer from whom it was purchased, please contact Roberts Radio Technical Services at the address shown on the rear of this manual.

These statements do not affect the statutory rights of a consumer.

ROBERTS RADIO TECHNICAL SERVICES

97-99 Worton Road
Isleworth Middlesex

TW7 6EG

Technical Helpline :- 020 8758 0338 (*Mon-Fri during office hours*)

Website: <http://www.robertsradio.co.uk>

Download from www.Somanuals.com. All Manuals Search And Download.



Free Manuals Download Website

<http://myh66.com>

<http://usermanuals.us>

<http://www.somanuals.com>

<http://www.4manuals.cc>

<http://www.manual-lib.com>

<http://www.404manual.com>

<http://www.luxmanual.com>

<http://aubethermostatmanual.com>

Golf course search by state

<http://golfingnear.com>

Email search by domain

<http://emailbydomain.com>

Auto manuals search

<http://auto.somanuals.com>

TV manuals search

<http://tv.somanuals.com>