

# ROBERTS

Sound for Generations

# RD-6

FM RDS/DAB digital radio



*Gemini 6*

**DAB**  
Digital Audio Broadcasting

Please read this manual before use

## Contents

<i>Controls</i> .....	2-3	<i>Clock display</i> .....	19
<i>Mains operation</i> .....	4	<i>General</i> .....	20
<i>Operating your radio - DAB</i> .....	5	<i>Specifications</i> .....	20
<i>Selecting a station - DAB</i> .....	6	<i>Circuit features</i> .....	20
<i>Secondary services - DAB</i> .....	7	<i>Mains Supply</i> .....	21
<i>Display modes - DAB</i> .....	7	<i>Guarantee</i> .....	22
<i>Finding new stations - DAB</i> .....	8		
<i>Autoselect - DAB</i> .....	8		
<i>Manual tuning - DAB</i> .....	9		
<i>Signal strength display - DAB</i> .....	9		
<i>Operating your radio - FM</i> .....	10		
<i>Manual tuning - FM</i> .....	11		
<i>Display modes - FM</i> .....	12		
<i>FM stereo/mono</i> .....	12		
<i>Presetting stations - FM</i> .....	13		
<i>Recalling a preset station - DAB and FM</i> .....	13		
<i>System reset</i> .....	14		
<i>Headphone and optical output sockets</i> .....	15		
<i>Display backlight</i> .....	15		
<i>Remote control</i> .....	16		
<i>Remote handset battery replacement</i> .....	17		
<i>Using the remote control</i> .....	18		

## Controls

(Front)

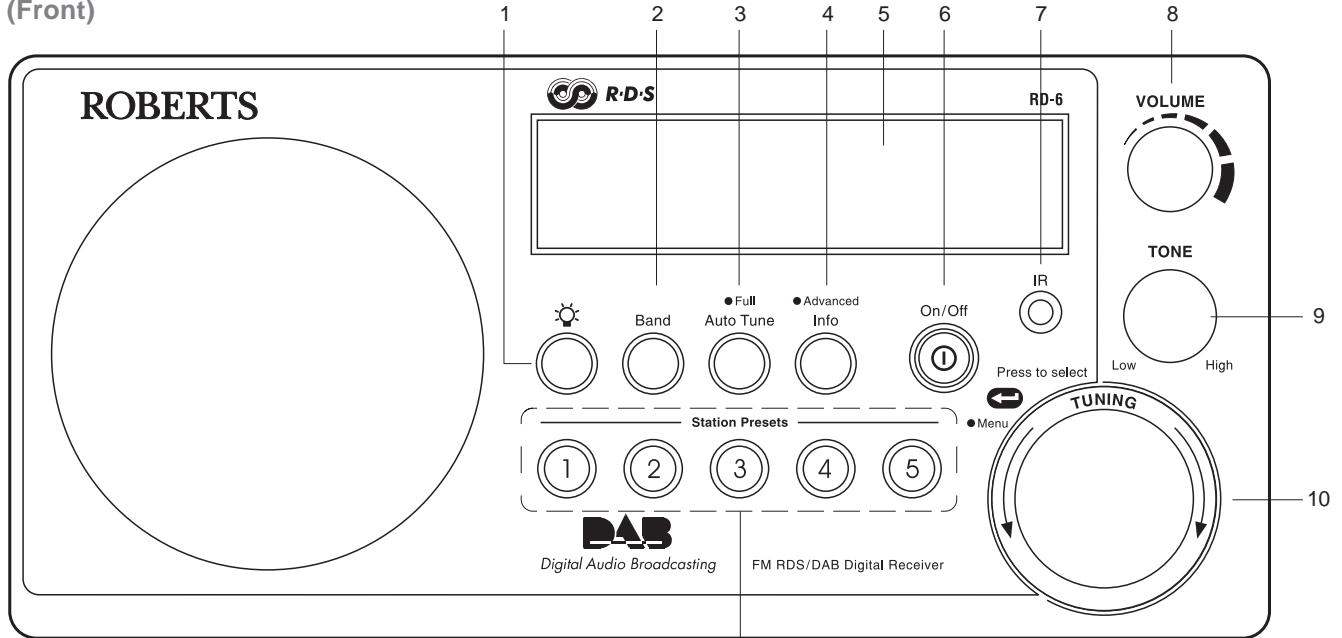

- |  |                    |                     |
|--|--------------------|---------------------|
| 1. Light button                        | 11. Preset buttons | 7. Infra Red sensor |
| 2. Band button                         |                    | 8. Volume control   |
| 3. Auto tune button                    |                    | 9. Tone control     |
| 4. Info button                         |                    | 10. Tuning control  |
| 5. LCD display                         |                    |                     |
| 6. On/Off button and StandBy indicator |                    |                     |

## Controls

(Rear)

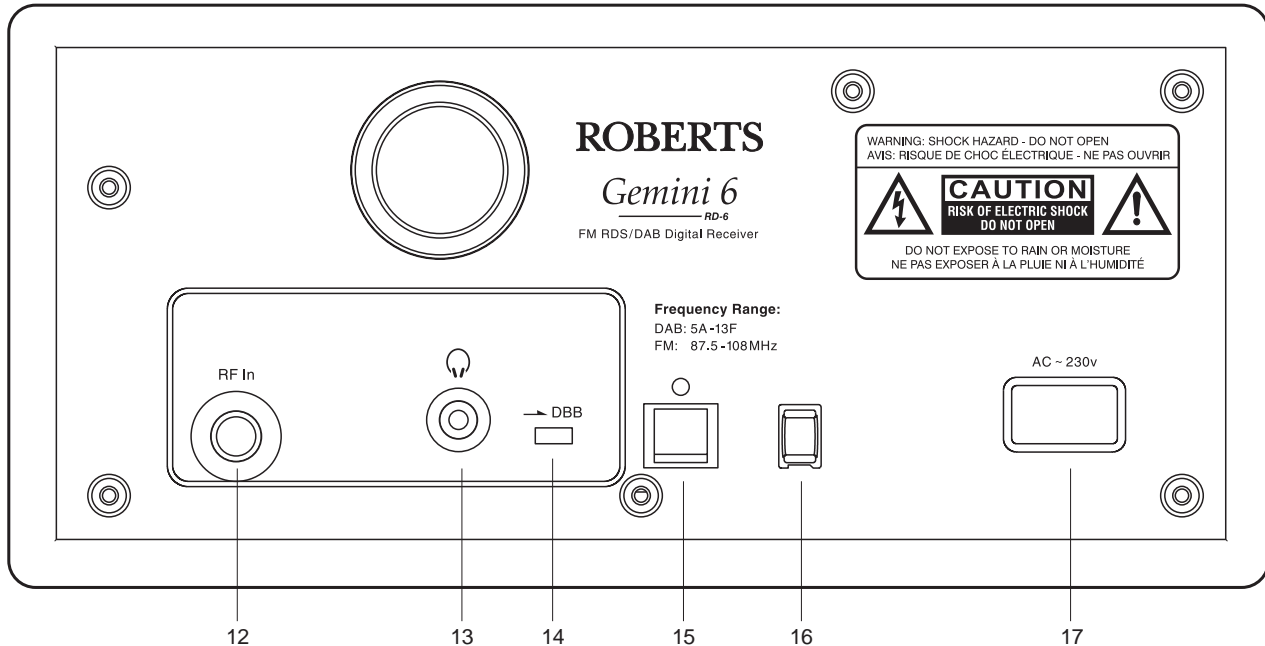

12. Telescopic aerial

13. Headphone socket

14. Deep bass boost switch

15. Optical output socket (Toslink)

16. Telescopic aerial holder

17. Mains input socket

## Mains operation

1. Place your radio on a flat surface.
2. Plug the mains lead into the **Socket** located on the rear of your radio ensuring that the plug is pushed fully into the socket.
3. Plug the other end of the mains lead into a wall socket and switch on the wall socket.

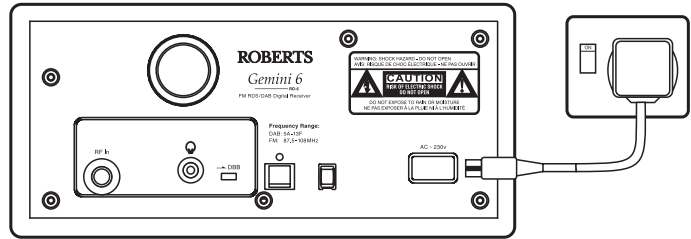

## Operating your radio - DAB

1. Fully extend the telescopic aerial.
2. Press the **On/Off button** to switch on your radio. The display will show "Roberts DAB digital radio" for a few seconds.
3. If this is the first time the radio is used a quick scan of UK Band III DAB channels will be carried out. The display will show "Autotune Quick scan". If the radio has been used before the last used station will be selected.
4. During Autotune as each group of stations is detected the bottom line of the display will show its name and the station count will be updated. The top line of the display shows a bargraph indicating progress of the Autotune.
5. When the Auto tune is complete the first station (in numeric-alpha order 0...9...A....Z) will be selected.
6. If the station list is still empty after the Autotune your radio will display "No Signal".
7. If no signals are found it may be necessary to relocate your radio to a position giving better reception.

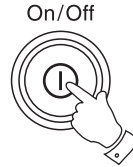
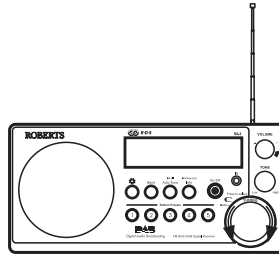

Roberts

Autotune  
Quick scan

■■■■□□□□□□□□  
Searching...

■■■■■■■■■■□□□□ 24  
BBC National DAB

1Xtra DAB  
BBC National DAB

No signal DAB

## Selecting a station - DAB

1. The top line of the display shows the name of the station currently selected.
2. Rotate the **Tuning control** to scroll through the list of available stations. Stop rotating the Tuning control when you find the station that you wish to hear.
3. Press and release the **Tuning control** to select the station. The display may show "Tuning" while your radio finds the new station.
4. Adjust the **Volume, Tone and Deep bass boost switch** to the required settings.

Note: If after selecting a station the display continues to show "Not Available" it may be necessary to relocate your radio to a position giving better reception.

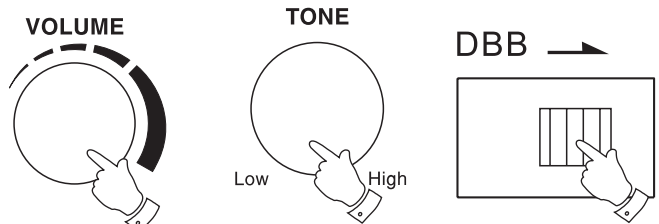
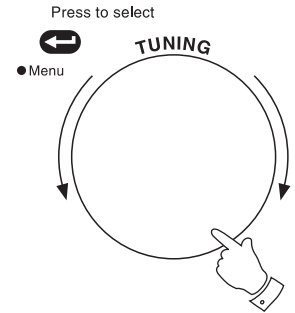

## Secondary services - DAB

1. Certain radio stations have one or more secondary services associated with them. If a station has a secondary service associated with it the display will show ">" next to the station name on the station list. The secondary service will then appear immediately after the primary service as you rotate the tuning control clockwise.

BBC5Live> DAB  

>BBC 5prtx DAB  

## Display modes - DAB

Your radio has five display modes:-

1. Press the **Info button** to cycle through the various modes.

● Advanced  
Info



- |                    |   |
|--------------------|---|
| a. Scrolling text  | Displays scrolling text messages such as artist/track name, phone in number, etc. |
| b. Programme type  | Displays type of station being listened to e.g. Pop, Classic, News, etc.          |
| c. Multiplex Name  | Displays name of multiplex to which current station belongs.                      |
| d. Signal strength | Displays signal strength for station being listened to.                           |
| e. Time and date   | Displays current time and date.   |

a BBC 7 DAB  
Just a Minute...

b BBC 7 DAB  
Culture

c BBC 7 DAB  
BBC National DAB

d BBC 7 DAB  

e BBC 7 DAB  
19:17 08-06-2003



## Finding new stations - DAB

As time passes new stations may become available. To find new stations proceed as follows:-

1. Press and release the **AutoTune button**, the display will show "Autotune Quick Scan". Your radio will perform a scan of the UK DAB frequencies. As new stations are found the station counter on the right-hand side of the display will increase and stations will be added to the list
2. To carry out a full scan of the entire DAB Band III frequencies press and hold down the **AutoTune button** for more than 2 seconds and then release. The display will show "Autotune Full scan". As new stations are found the station counter on the right-hand side of the display will increase and stations will be added to the list

● Full  
Auto Tune



Autotune  
Quick scan

■■■■■■■■■■□□□□ 24  
BBC National DAB

● Full  
Auto Tune



Autotune  
Full scan

## Autoselect - DAB

As an alternative to pressing the tuning control to select a station your radio can be set so as to automatically select a station.

1. Rotate the **Tuning control** a few clicks in either direction, immediately press and hold in the tuning control until the display shows "Autoselect ON".
2. Rotate the **Tuning control** until the station you require is visible on the display, after a few seconds your radio will automatically select the station shown on the display.
3. To switch off Autoselect rotate the **Tuning control** a few clicks in either direction, immediately press and hold in the **Tuning control** until the display shows "Autoselect OFF".

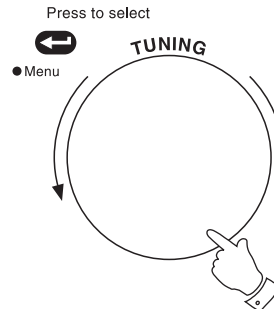

Autoselect ON

BBC 7 DAB  
BBC National DAB

Autoselect OFF

## Manual Tuning - DAB

Manual tuning allows you to tune directly to the various DAB Band III channels. UK DAB stations located in the range 11B to 12D.

1. Press and hold in the Tuning **control** until the display shows "Manual tune".
2. Rotate the **Tuning control** to select the required DAB channel.
3. Press and release the **Tuning control** to select the channel.
4. Rotate the **Tuning control** to select the stations contained within the Multiplex for the selected DAB channel.
5. Press and release the **Tuning control** to return to normal tuning mode.

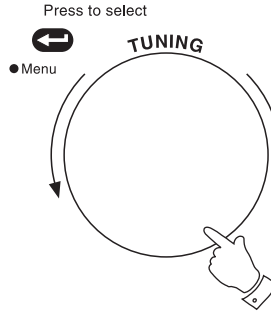

Manual tune

12B 225.648 MHz  
BBC National DAB

BBC 7 MAN  
BBC National DAB

BBC 7 DAB  
BBC National DAB

## Signal strength display - DAB

1. Repeatedly press and release the **Info button** until the lower line of the display shows signal strength.
2. Position your radio and angle the telescopic aerial for best reception using the signal strength display as a guide. Move your radio around and position so as to give maximum number of black rectangles on signal strength display.
3. The clear unfilled rectangle indicates minimum signal level required for satisfactory reception.

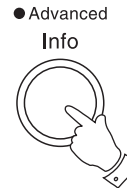

BBC 7 DAB  
■■■■■□■■■■■

## Operating your radio - FM

1. Fully extend the telescopic aerial.
2. Press the **On/Off button** to switch on your radio. The display will show "Roberts DAB digital radio" for a few seconds.
3. Press the **Band button** to select the FM band.
4. Press and immediately release the **Auto Tune button**, your radio will scan in an upwards direction (low frequency to high frequency) and stop automatically when it finds a station of sufficient strength.
5. After a few seconds the display will update and show station name.
6. To find other stations press and release the **AutoTune button** as before.
7. To scan the FM band in a downwards direction (high frequency to low frequency) press and hold down the **AutoTune button** for 0.5 seconds and then release.
8. When the waveband end is reached your radio will recommence tuning from the opposite waveband end.
9. Adjust the **Volume, Tone and Deep bass boost switch** to the required settings.
10. To switch off your radio press the **On/Off button**.

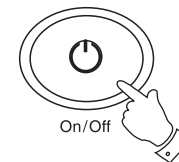
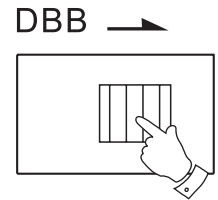
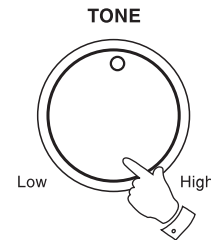
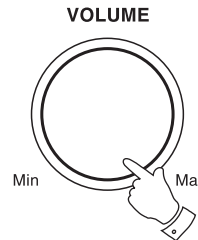
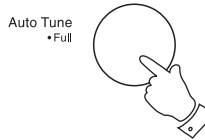
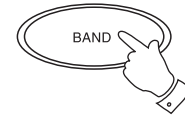
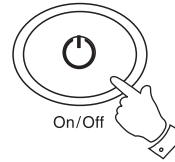

## Manual tuning - FM

1. Press the **On/Off button** to switch on your radio.
2. Press the **Band button** to select the FM band. Fully extend the **Telescopic aerial**.
3. Rotate the **Tuning control** to tune to a station. The frequency will change in steps of 50kHz.
4. When the waveband end is reached the radio will recommence tuning from the opposite waveband end.
5. Set the **Volume, Tone and Deep bass boost switch** to the desired settings.
6. To switch off your radio press the **On/Off button**.

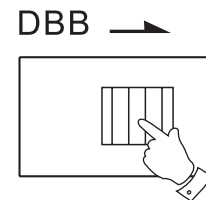
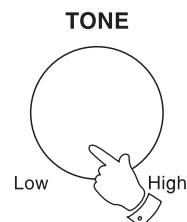
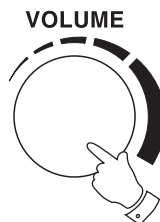
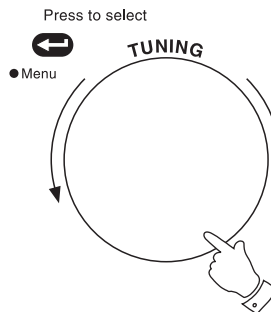

## Display modes - FM

On FM the bottom line of the display can be set to any of the following modes:-

1. Press the **Info button** to cycle through the various modes.

- |                    |  |
|--------------------|--|
| a. Scrolling text  | Displays scrolling text messages such as artist/track name, phone in number etc. |
| b. Program Type    | Displays type of station being listened to e.g. Pop, Classic, News, etc.         |
| c. Signal strength | Displays signal strength for station being listened to.                          |
| d. Time and date   | Displays current time and date.  |
| e. Frequency       | Displays frequency of the station being listened to.                             |
| f. Audio mode      | Display shows Auto (stereo) or mono.   |

● Advanced Info



- |   |                               |
|---|-------------------------------|
| a | BBC R2 FM<br>The latest news  |
| b | BBC R2 FM<br>Pop Music        |
| c | BBC R2 FM<br>■■■■■□■■■■       |
| d | BBC R2 FM<br>88.10MHz         |
| e | BBC R2 FM<br>12:02 16-06-2003 |
| f | BBC R2 FM<br>Auto (Stereo)    |

## FM Stereo/Mono

- If a station being received is weak some hiss may be audible. To reduce the hiss press and hold in the **Tuning control** until the display shows "Audio mode : mono" your radio will switch to mono mode.
- To return to stereo mode press and hold in the **Tuning control** until the display shows "Audio mode :Auto", your radio will switch to stereo mode.

Note: FM stereo is only available when using earphone/headphones

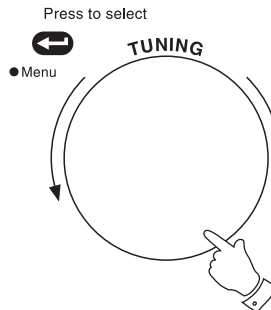

Audio mode: Mono

Audio mode: Auto

## Presetting stations - DAB and FM

There are 5 memory presets for each of the 2 wavebands.

1. Press the **On/Off button** switch on the radio.
2. Tune to the required station as previously described.
3. Press and hold down the required **Preset button** until the display shows e.g. "Preset 1 stored". The station will be stored under the chosen preset button. Repeat this procedure for the remaining presets.
4. Stations stored in preset memories may be overwritten by following the above procedure.

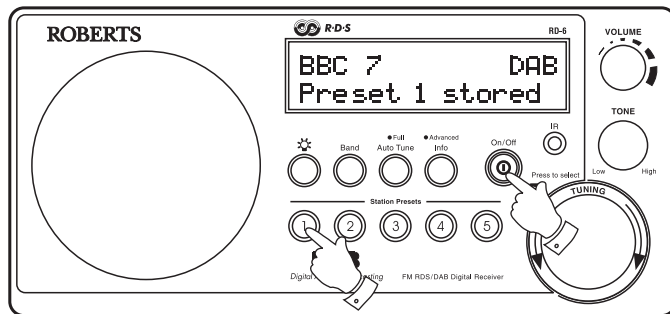

## Recalling a preset station - DAB and FM

1. Press the **On/Off button** to switch on the radio.
2. Select the required waveband by pressing the **Band** button.
3. Momentarily press the required **Preset button**, your radio will tune to the station stored in preset memory.

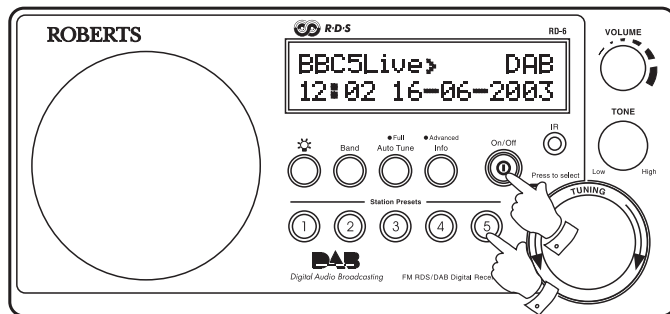

## System reset

If your radio fails to operate correctly, or some digits on the display are missing or incomplete carry out the following procedure.

1. Switch off your radio.
2. Switch on your radio - as soon as the screen shows "Roberts DAB digital radio" press and hold in the Tuning control until the display shows "System Reset".
3. A full reset will be performed. All presets and station lists will be erased.
4. If DAB was used last then a "Quick scan" of the DAB band will be performed, otherwise a "Quick scan" will be carried out the next time the DAB band is selected.

If a problem persists our technical staff would be pleased to help offer any assistance on operating the radio. Our technical helpline number is 020 8758 0338.

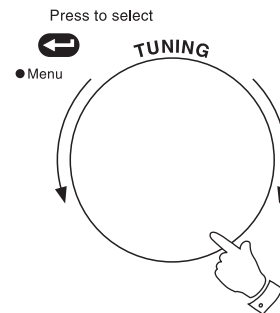

System reset

Autotune  
Quick scan

■■■■□□□□□□□□  
Searching...

■■■■■■■■■■□□□□ 24  
BBC National DAB

## Headphone and optical output sockets

1. A 3.5mm **Headphone Socket** located on the rear of your radio is provided for use with either headphones or an earpiece. Inserting a plug automatically mutes the internal loudspeaker.
2. A digital optical output socket is provided on the rear of your radio for connection to a an amplifier, mini-disc or other equipment with a digital optical input.

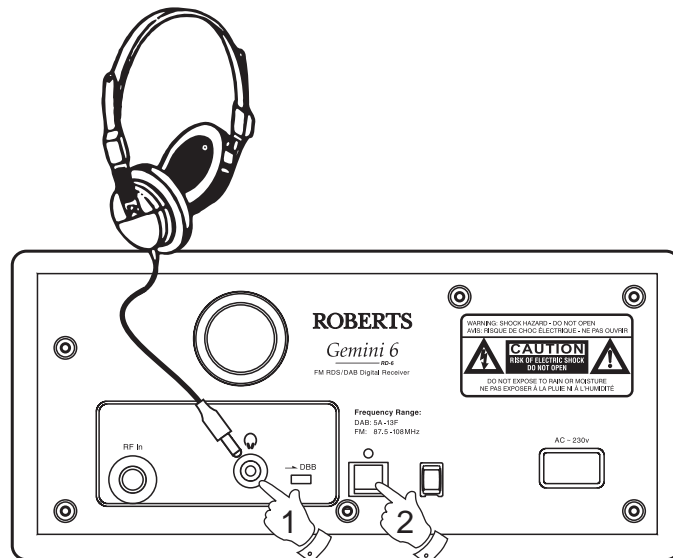

## Display backlight

1. The display backlight can be switched on and off using the **Light button**.

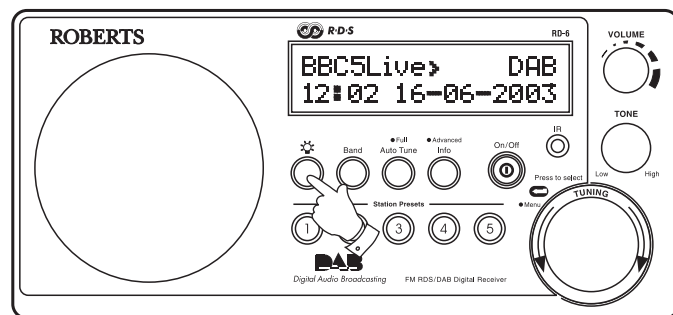



## Remote control

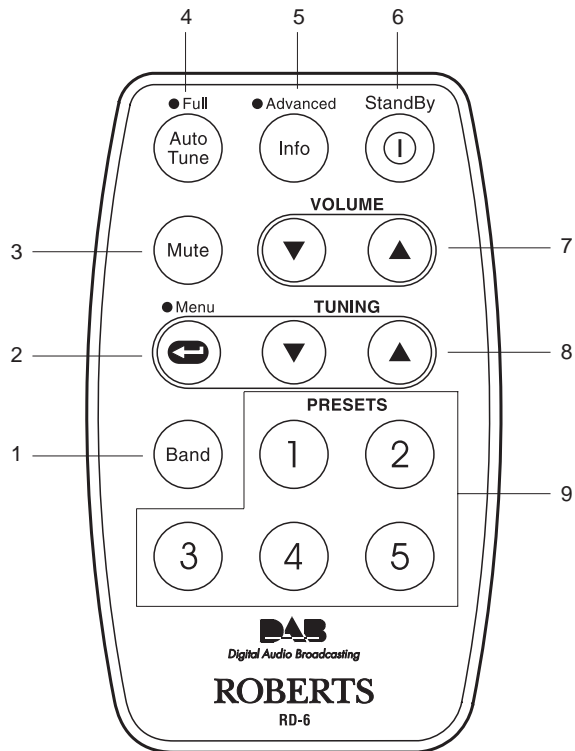

1. Band button
2. Select button
3. Mute button
4. Auto tune button
5. Info button
6. StandBy button

7. Volume up/down buttons
8. Tuning up/down buttons
9. Preset buttons

## Remote handset battery replacement

1. With the aid of the end of a paper clip slide catch in direction shown.
2. Remove battery holder by pushing holder in direction shown.
3. Remove battery from holder.
4. Replace battery (2025 or equivalent) ensuring that positive side of battery faces you with holder positioned as shown.
5. Replace the battery holder.

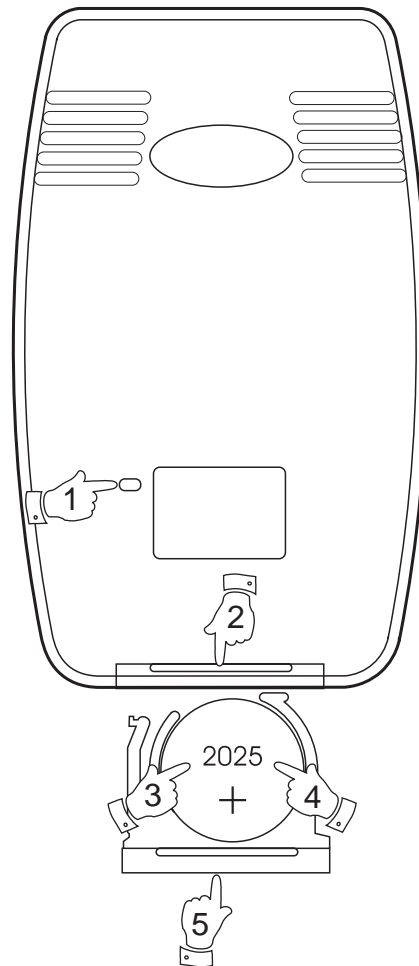

## Using the remote control

The buttons on the remote control have the same functions as front panel controls with two exceptions:-

1. Mute - press this button to mute sound, press again to restore sound.
2. StandBy - press this button to place unit in StandBy mode, your radio will enter power down state but the clock will remain active. The StandBy indicator will light.

If the front panel On/Off button is pressed during StandBy your radio will switch off and clock display will not be visible.

Note: the front panel On/Off control will return unit to its previous state prior to the On/Off button being used i.e. If radio is in StandBy mode and On/Off button is used to switch off radio - when On/Off button is used to switch back on radio will power up in StandBy mode.

or

If radio is in On mode and On/Off button is used to switch off radio - when On/Off button is used to switch back on radio will power up in On mode.

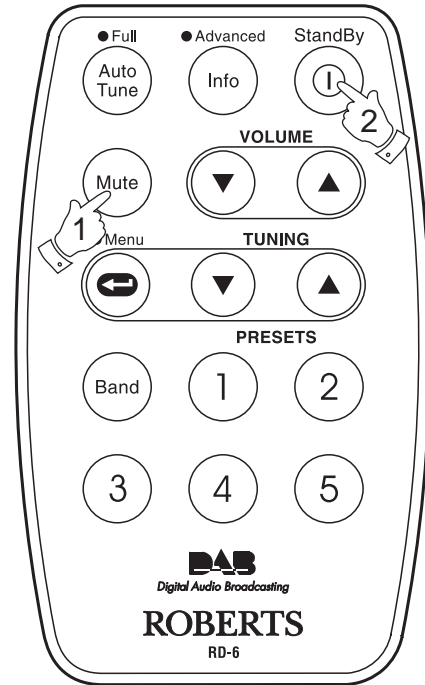

## Clock display

1. Your radio will display clock time when in set to StandBy mode using the remote handset.
2. During StandBy mode the clock will receive updates from the last station tuned to before entering standby mode.  
When in StandBy mode your radios clock will automatically track Summer/Winter time changes.
3. The clock will not show in the display when the radio is switched off using the the On/Off button on the front panel

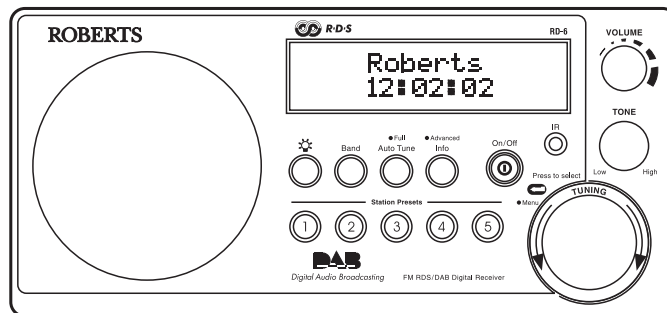

## General

Do not allow this radio to be exposed to water, steam or sand. Do not leave your radio where excessive heat could cause damage. It is recommended that the DAB band be used wherever possible as better results in terms of quality and freedom from interference will usually be obtained than on the FM band.

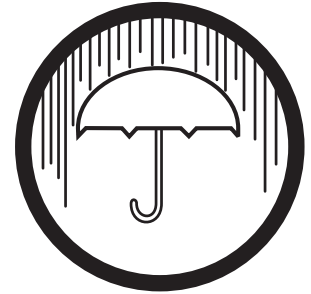
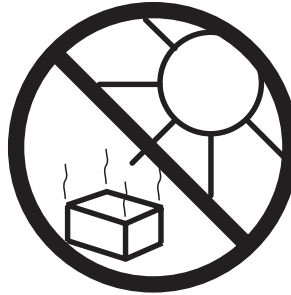

---

## Specifications

### Power Requirements

Mains	AC 230 volts, 50Hz  only
Battery (Remote control)	3.0V 2025 button type

### Frequency Coverage

FM	87.5-108MHz
DAB	174.928 - 239.200MHz

## Circuit Features

Loudspeaker	75mm 8ohms
Output Power	5 Watts
Headphone socket	3.5mm dia
Aerial System	FM Telescopic aerial
	DAB Telescopic aerial

## Mains supply

The RD-6 will operate from a supply of AC 230 volts, 50Hz  only.

**DO NOT cut off the mains plug from this equipment.** If the plug fitted is not suitable for the power points in your home or the cable is too short to reach a power point, then obtain an appropriate safety approved extension lead or adaptor. If in doubt consult your dealer.

If nonetheless the mains plug is cut off, remove the fuse and dispose of the plug immediately to avoid a possible shock hazard by inadvertent connection to the mains supply.

If this product is not supplied with a mains plug, or one has to be fitted, then follow the instructions given below:

**IMPORTANT. DO NOT** make any connection to the larger terminal which is marked with the letter E or by the safety earth symbol  or coloured Green or Green-and-yellow.

The wires in the mains lead are coloured in accordance with the following codes :-

BLUE - NEUTRAL

BROWN - LIVE

The wire coloured BLUE must be connected to the terminal marked N or coloured BLACK.

The wire coloured BROWN must be connected to the terminal marked L or coloured RED.

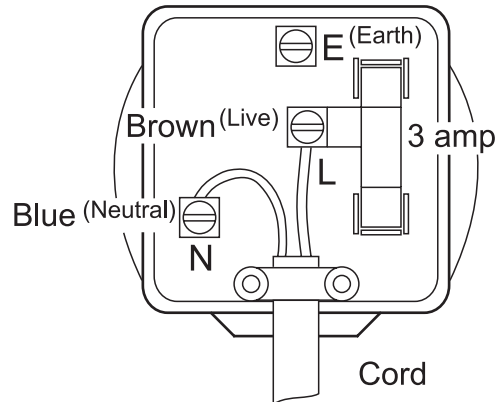

## Fuse

When replacing the fuse only a 3A ASTA approved to BS1362 type should be used and be sure to re-fit the fuse cover.

IF IN DOUBT - CONSULT A QUALIFIED ELECTRICIAN.

Replacement fuse holders are available from Roberts Radio Technical Services at the address shown on the rear of this manual.

## Guarantee

This instrument is guaranteed for twelve months from the date of delivery to the original owner against failure due to faulty workmanship or component breakdown, subject to the procedure stated below. Should any component or part fail during this guarantee period it will be repaired or replaced free of charge.

The guarantee does not cover:

1. Damage resulting from incorrect use.
2. Consequential damage.
3. Receivers with removed or defaced serial numbers.

N.B. Damaged or broken telescopic aerials will not be replaced under guarantee.

Procedure:

Any claim under this guarantee should be made through the dealer from whom the instrument was purchased. It is likely that your Roberts' dealer will be able to attend to any defect quickly and efficiently, but should it be necessary the dealer will return the instrument to the company's service department for attention. In the event that it is not possible to return the instrument to the Roberts' dealer from whom it was purchased, please contact Roberts Radio Technical Services at the address shown on the rear of this manual.

**ROBERTS RADIO TECHNICAL SERVICES**

97-99 Worton Road

Isleworth Middlesex

TW7 6EG

Technical Helpline :- 020 8758 0338 (*Mon-Fri during office hours*)

*Issue 1*

Download from [Www.Somanuals.com](http://www.somanuals.com). All Manuals Search And Download.





## Free Manuals Download Website

<http://myh66.com>

<http://usermanuals.us>

<http://www.somanuals.com>

<http://www.4manuals.cc>

<http://www.manual-lib.com>

<http://www.404manual.com>

<http://www.luxmanual.com>

<http://aubethermostatmanual.com>

Golf course search by state

<http://golfingnear.com>

Email search by domain

<http://emailbydomain.com>

Auto manuals search

<http://auto.somanuals.com>

TV manuals search

<http://tv.somanuals.com>