

ROBERTS

RD4

Digital Audio Broadcasting (DAB)
Sports Radio



Operating Instructions

Download from www.Somanuals.com. All Manuals Search And Download.

Contents

<i>Contents</i>	2
<i>Controls</i>	3
<i>Display Screen</i>	6
<i>Batteries</i>	8
<i>Hold switch</i>	10
<i>Earphones</i>	12
<i>Aerial</i>	12
<i>Display Icons</i>	14
<i>Switching the Radio On</i>	16
<i>Digital Label (DLS)</i>	18
<i>Displaying the Signal Level</i>	20
<i>Adjusting the Volume Level</i>	20
<i>Selecting a Station</i>	22
<i>Presetting Stations</i>	24
<i>Recalling a Preset Station</i>	26
<i>Adjusting the Tone</i>	28
<i>Using the Menu Function</i>	30
<i>Station Order</i>	32
<i>Adjusting the Station Order</i>	34
<i>Autoscan Tuning</i>	36
<i>Manual Tuning</i>	38
<i>Switching the Radio Off</i>	40
<i>Reset</i>	42
<i>Troubleshooting</i>	44
<i>General</i>	46
<i>Specification</i>	47
<i>Guarantee</i>	<i>back cover</i>

Controls

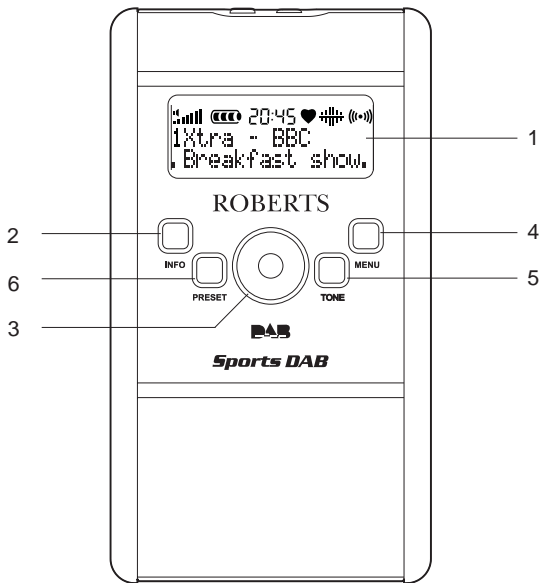

1. LCD Display screen

2. Info button

3. Select button

4. Menu button

5. Tone button

6. Preset button

Controls

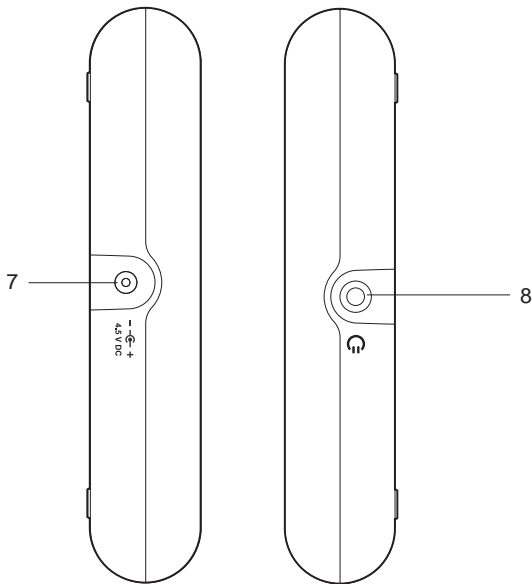

7. Power Supply socket

8. Earphone socket

Controls

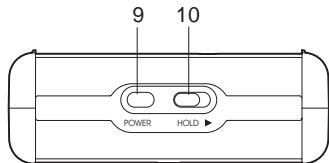

9. Power button

10. Hold switch

Display Screen

The radio includes a back lit LCD **Display Screen**.

The icons at the top of the screen form a custom display indicating the status of the radio and any user settings.

The two-line alphanumeric display at the bottom of the screen can show up to 16 characters on each line, and provide information about the received stations.

Back Light

The **Back Light** illuminates the **Display Screen**, making it easy to view in a dark environment.

1. When the **Power button** is pressed to turn the radio on, the **Display Screen** will illuminate for five seconds.
2. When the **Power button** is pressed to turn the radio off, the **Display Screen** will illuminate for a short period.
3. When a button is pressed the **Display Screen** will illuminate for up to three seconds.
4. When the radio is powered externally, by connecting a suitable external power supply (4.5 V DC) to the **Power Supply Socket** on the radio, the **Display Screen** remains constantly illuminated.

Display

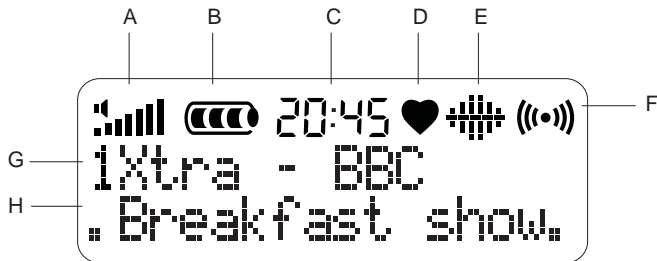

A. Volume Level icon

B. Battery Level icon

C. Clock

D. Favourites icon

E. Tone icon

F. Signal Strength icon

G. Alphanumeric Display Line 1

H. Alphanumeric Display Line 2

Batteries

1. Open the battery cover located on the rear of the your radio by sliding it in the direction shown by the arrow.
2. Insert 3 x AA size batteries into the compartment. Make sure the (+) and (-) ends of the batteries are positioned as shown inside the compartment.
3. Close the battery cover
4. Batteries should be replaced when the the **Battery Level** icon shows low. The image shows a battery level icon consisting of a horizontal rectangle with a small black segment on the left side, indicating a low charge level.
5. Press the **Power** button to switch the radio off before replacing batteries.
6. Press the **Power** button to switch the radio on after batteries have been replaced.
7. If the radio is not be used for an extended period of time it is recommended that the batteries are removed from the radio.
8. The radio retains all settings. Battery replacement does not cause a Reset.
9. When the power is too low for the radio to operate, the icon will flash and the unit will shut down automatically.

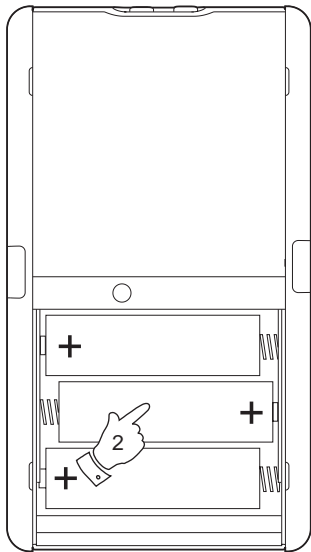
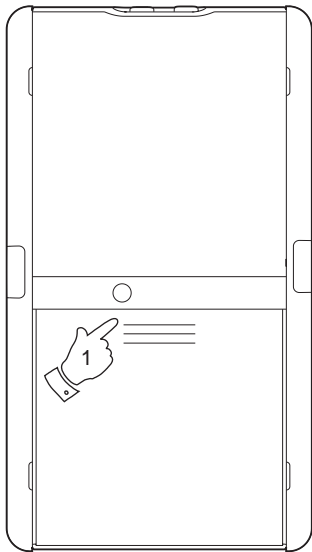

Hold switch

The **Hold switch** is used to prevent unintentional operation of your radio.

1. Move the **Hold switch** on the top of the unit to the “Hold” position, as indicated by the arrow. The power and all other buttons will be disabled, this will prevent accidental operation when your radio is packed in a suitcase or travel bag.
2. To prevent accidental operation of the controls when your radio is switched on, move the **Hold switch** on the top of the unit to the “Hold” position as indicated by the arrow.
3. To release the **Hold switch**, move the **Hold switch** on the top of the unit to the “Off” position.

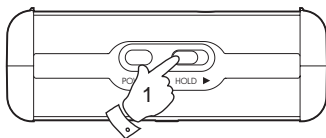

Earphones

Plug the earphones into the **Earphone Socket** on the side of the unit.

Check the **Volume Level** icon shows that the volume is not too loud and place the ear-pieces into your ears.

Do not turn on the radio with the earphones connected and inserted in your ear. Loud noises can damage your hearing.

Aerial

The lead connecting earphones to your radio acts as an aerial when plugged into the **Earphone socket**. The lead should be extended as much as possible to increase reception.

Earphones

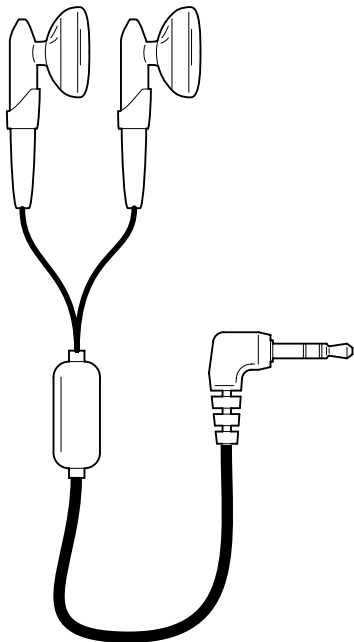

Volume Level Icon

The number of bars displayed (0 - 7) indicates the current volume.

Battery Level Icon

The number of bars displayed (0 - 3) indicates the remaining power.

Clock

The clock displays the time in 24-hour format as broadcast by DAB stations. The **Clock** is only visible when DAB is being received.

Favourites Icon

The **Favourites** icon displays when tuned to one of the top ten most listened to stations.

Tone Icon

The **Tone** icon indicates the type of equalisation that has been selected for the station playing. There are six equalisation settings.

Signal Strength Icon

The **Signal Strength** icon indicates the strength of the signal for the station currently playing. The icon changes with the signal.

Volume Level Icons



Battery Level Icons



Clock

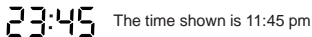

Favourite Icon



Tone Icons



Signal Strength Icons



Switching the Radio On

1. Check that the batteries have been installed correctly.
2. Ensure that the **Hold switch** on the top of the unit is in the “Off” position.
3. Plug the earphones into the socket on the side of the unit.
4. Press the **Power button** on the top of the unit.
5. The **Display Screen** will illuminate to show a welcome message.
6. After a short period the message will change. The first time the radio is switched on, or following a reset, the screen will show that it is scanning for available stations.
7. When the stations have been found the receiver lists them alphanumerically, and tunes the radio to the first station in the list.
8. The station name and the first line of the scrolling Digital Label (DLS) will show on the **Display Screen**.
9. If no stations are found a message will be displayed, followed by a menu providing the opportunity to tune the radio in.

On subsequent occasions when the radio is switched on the receiver will tune the radio to the last selected station and display previous icon settings.



Welcome to
Digital Radio



Scanning...



Now tuning...



23:25



1Xtra - BBC
DLS scrolling...



No Stations
available



◀ or SELECT
▶ Manual tune... ▶
◀ Autoscans ▶

Digital Label (DLS)

1. After a station has been tuned and is playing, the station name will appear on the first line of the **Display Screen**.
2. The bottom line displays the first line of the **Digital Label (DLS)**. This information is broadcast along with the audio and contains information relevant to the current broadcast content, and technical data about the station.
3. Press the **Info button** to step through and display the DLS information.

Example DLS information:

- . 1Xtra : BBC
- . Program type : Other music
- . Multiple name : BBC National DAB
- . Date : 05-01-2003
- . Channel & Frequency : 12B 225.64MHz
- . Bitrate mode : 128kbps stereo
- . Signal Error : 2

The DLS Information is usually longer than 16 characters, so appears to scroll in a continuous loop along the bottom line of the **Display Screen**.

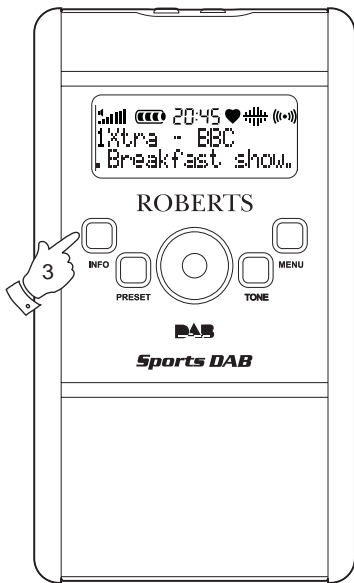

Displaying the Signal Level

While the radio is in play mode the **Select** button can be used to display the current station **Signal Level**.

1. Pressing the **Select** button will display a bar graphic indicating the signal level. The minimum required signal for this station is presented as an open box on the bar.
2. Press the **Select** button to cancel the **Signal Level** function.

Adjusting the Volume Level

While the radio is in play mode the **Select** button can be used to alter the volume.

1. Push the **Select** button up or down to increase or decrease the volume.
2. For every two moves in a single direction a bar is added to or removed from the **Volume Level** icon.
3. Pushing the **Select** button continuously in a single direction will continue to alter the volume until the button is released or the maximum/minimum level is reached.
4. When the radio is scanning or selecting stations the volume will be muted - but the **Volume Level** icon will not change.

Signal Level

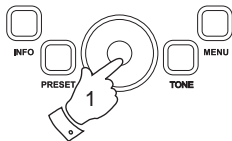

Volume Level

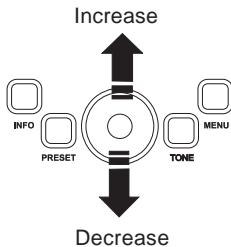

Selecting a Station

While the radio is in play mode you can step through the list of available stations by using the **Select** button.

1. Push the **Select** button right or left to move the list forward or back. The station names will appear in the bottom line of the **Display Screen** with arrows on either side
2. When the last station in the list is shown pushing the **Select** button to the right will display the first station in the list.
3. To change the station being played, press the **Select** button. The radio will tune to your selection.
4. If no station is selected or the interval between button presses is greater than seven seconds the function will time out and the **Display Screen** will revert to play mode.

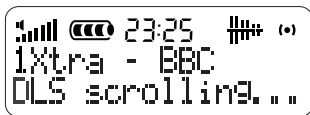

Presetting stations

Selected stations can be stored in memory using the preset function. To assign a station to a preset the radio must be in play mode.

1. Press the **Preset button** to access the preset function.
2. The first of a list of ten presets is displayed in the bottom line of the **Display Screen**.
3. Push the **Select** button right or left to move the list forward or back until you find an empty preset or one you would like to overwrite.
4. Press the **Preset button** and hold for more than two seconds, until the **Display Screen** confirms that the preset has been saved.

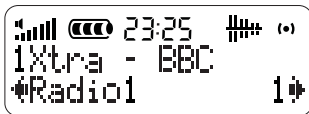

Backward



Forward



Recalling a preset station

To select and play a preset station use the **Select** button to step through the list.

1. Press the **Preset button** to access the preset function.
2. The first of a list of ten presets is displayed in the bottom line of the **Display Screen**.
3. Push the **Select** button right or left to move the list forward or back.
4. If a station has been stored in the preset, the name of the station and the number of the preset will be displayed with arrows on either side.
5. To change the station being played, press the **Select** button. The radio will tune to your preset selection.

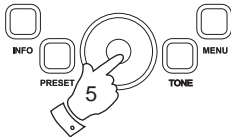
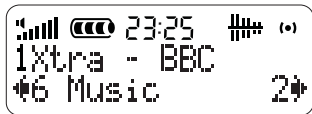
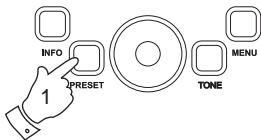

Adjusting the Tone

While the radio is in play mode the **Tone button** can be used to change the tone.

The current tone is shown on the **Display Screen** by the Tone icon.

1. Press the **Tone button** to change the tone setting.

List of tone settings:

MBass

Monitor

Studio

Club

Arena

Flat

2. The next tone setting will be applied to the current station.

3. The Tone icon changes to reflect the setting.

4. Press the **Tone button** until the desired tone is set.

5. The Tone setting is saved when the radio is switched off. This setting will be applied when the radio is next switched on.

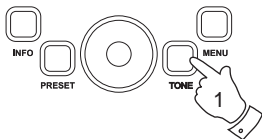

Signal strength icon, Full battery icon, 23:08, Equalizer icon, ((•))
 iXtra - BBC
 DLS scrolling...

Monitor

Signal strength icon, Full battery icon, 23:08, Equalizer icon, ((•))
 iXtra - BBC
 DLS scrolling...

Studio

Signal strength icon, Full battery icon, 23:08, — icon, ((•))
 iXtra - BBC
 DLS scrolling...

Flat

Signal strength icon, Full battery icon, 23:08, Equalizer icon, ((•))
 iXtra - BBC
 DLS scrolling...

Arena

Signal strength icon, Full battery icon, 23:08, Equalizer icon, ((•))
 iXtra - BBC
 DLS scrolling...

Club

Signal strength icon, Full battery icon, 23:08, Equalizer icon, ((•))
 iXtra - BBC
 DLS scrolling...

MBass

Using the Menu Function

There are a number of system settings that can be accessed from the Menu function.

List of system settings:

Station Order
Manual Tune
Autoscan local
Software version

1. Press the **Menu button** to access the list of system settings.
2. Push the **Select** button right or left to move the list forward or back until you find the desired system setting.
3. Press the **Select** button to choose the setting.

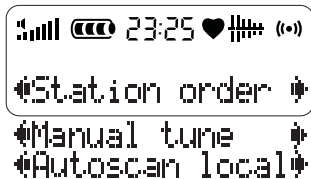
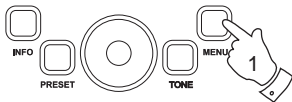

Station Order

When the radio is switched on it compiles a list of stations. The Station Order functions can change the way this list is displayed on the **Display Screen**. The default Station Order is alphanumeric.

Selecting Station Order from the system setting Menu list will display a sub menu.

List of available arrangements:

Alphanumeric

Arranged in Number - Alphabetical order.

Active Station

Prioritises stations that a signal can be found for, and orders them alphanumerically. Stations that do not have a signal are appended to the list in alphanumerical order.

Prune Stations

Removes station from the list that do not have a signal.

Fav. Stations

Prioritises the ten most listened to stations and adds them to the start of the list.

Selecting this function will add the **Favourites** icon to the **Display Screen**.

📶 🔋 23:25 ❤️ 📶 (••)

◀ Station order ▶

◀ Alphanumeric ▶

◀ Active station ▶

◀ Prune stations ▶

◀ Fav station ▶

Adjusting the Station Order

1. Push the **Select** button right or left to move the list forward or back until you find the desired function.
2. Press the **Select** button to select the function.
3. When the Station Order is set to **Fav. Stations** browsing the Station Order sub menu from the system settings menu will show an additional option - **Favourite Presets**.
4. Selecting the **Favourite Presets** function will allocate your favourite stations to the preset list - overwriting any existing presets.

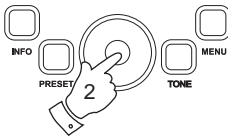

Autoscan Tuning

Selecting Autoscan local from the system setting Menu list will prompt the radio to scan for all available stations.

1. A scanning message and progress bar are shown on the **Display Screen**.
2. The number on the right hand side of the **Display Screen** represents the number of stations found. The number will update as the scanning progresses.
3. The volume is muted while the scanning takes place, but the **Volume Level** icon does not change.
4. When the scanning is complete the radio will return to play mode and the station you were listening to previously.

Signal strength icon, battery icon, 23:08, RDS icon, (•)
◀Autoscan local▶

Signal strength icon, battery icon, 23:08, RDS icon, (•)
Scanning... 10
Progress bar (10 segments)

Signal strength icon, battery icon, 23:08, RDS icon, (••)
1xtra - BBC
DLS scrolling...

Manual tuning

Selecting Manual tune from the system setting Menu list allows you to tune the radio to a specified channel.

To select a specific channel use the **Select** button to step through the list.

1. Push the **Select** button right or left to move the list forward or back until you find the desired channel.
2. Press the **Select** button to select the channel.
3. The **Display Screen** shows the signal strength bar.
4. To exit the Manual tune function press the **Select** button.

This radio has been designed for use in the UK only.

The UK frequency allocations for DAB Band III Services are channels:

11B
11C
11D
12A
12B
12C
12D

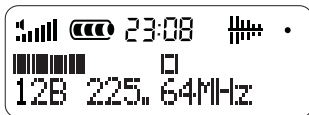
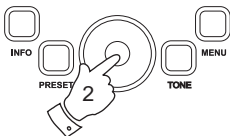

Switching the Radio Off

When the radio is switched off the current settings and station lists are saved for future use. If a reset is made before the radio is switched off then default settings will be saved.

1. Press the **Power button** on the top of the unit and hold for more than two seconds.
2. The **Display Screen** will illuminate and will display a power down message.
3. Release the **Power button** when the message clears. The radio is now off.

Powering off...

Reset

The Reset function will erase all settings and station orders set by the user, and restores default settings.

Default settings:

Station List is empty

All presets are empty

Station order is alphanumeric

Equalisation setting is MBass

Display mode is scrolling DLS

1. Press the **Menu** button down and hold for more than two seconds. The **Display Screen** will show a message asking you to confirm the reset.
2. Press the **Select** button down to confirm the reset.

If the **Select** button is not pressed within three seconds the function will time out and the **Display Screen** will revert to play mode.

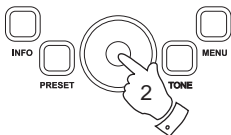

Troubleshooting

The radio is not working and the **Display Screen** is blank.

1. Press the **Power** button.
2. Check the condition of the batteries.
3. Check the batteries have been inserted correctly.

I cannot hear any sound through the earphones.

1. Plug the earphones into the **Earphone Socket** on the side of the unit.
2. Adjust the **Volume** level.

The radio has locked up.

1. If the radio is switched on and playing but the buttons do not appear to work, check the **Hold button** is not in the “Hold” position.
2. If the buttons still do not work **Reset** the radio. (See page 42).
3. If this does not resolve the problem, remove the batteries for one minute then replace them and try again.

Troubleshooting

The radio is receiving poor reception.

1. Check the **Signal Strength** icon shows that a suitable signal is being received.
2. Use the Autoscan function to rescan for all stations.
3. If the Autoscan function does not find a station use the Manual Tune function.
4. Ensure the aerial (earphone lead) is positioned for optimum reception.
5. Use the **Signal Strength** icon to find the best position.

General

Do not allow this unit to be exposed to moisture e.g. dripping or splashing. Do not leave your radio where excessive heat could cause damage such as in a parked car where the heat from the sun can build up even though the outside temperature may not seem too high.

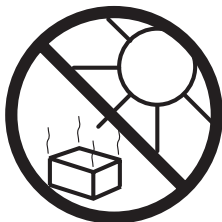

Specifications

Battery:	3 x AA size	
Battery Life:	Approx. ??hrs using alkaline batteries	?? F
External Power Supply:	4.5VDC 250mA, 2.1mm power jack positive tip (not supplied)	?? F
Frequency coverage:	217.5 - 230 MHz, (Band III, UK only)	
Earphone Jack:	32 ohms, in-ear style, with in-line aerial element	

The company reserves the right to amend the specification without notice

Guarantee

This radio is guaranteed for twelve months from the date of delivery to the original owner against failure due to faulty workmanship or component breakdown, subject to the procedure stated below. Should any component or part fail during this guarantee period it will be repaired or replaced free of charge.

The guarantee does not cover:

1. Damage resulting from incorrect use.
2. Consequential damage.
3. Product with removed or defaced serial numbers.

Procedure: Any claim under this guarantee should be made through the dealer from whom the instrument was purchased. It is likely that your Roberts' dealer will be able to attend to any defect quickly and efficiently but should it be necessary the dealer will return the instrument to the company's service department for attention. In the event that it is not possible to return the instrument to the Roberts' dealer from whom it was purchased, please contact Roberts Radio Technical Services at the address shown below before taking further action.

These statements do not affect the statutory rights of a consumer.

ROBERTS RADIO TECHNICAL SERVICES

97-99 WORTON ROAD
ISLEWORTH MIDDLESEX
TW7 6EG



Free Manuals Download Website

<http://myh66.com>

<http://usermanuals.us>

<http://www.somanuals.com>

<http://www.4manuals.cc>

<http://www.manual-lib.com>

<http://www.404manual.com>

<http://www.luxmanual.com>

<http://aubethermostatmanual.com>

Golf course search by state

<http://golfingnear.com>

Email search by domain

<http://emailbydomain.com>

Auto manuals search

<http://auto.somanuals.com>

TV manuals search

<http://tv.somanuals.com>