

ROBERTS

Sound for Generations

ecologic 4

FM RDS/DAB digital radio



DAB

Digital Audio Broadcasting

Please read this manual before use

Download from [Www.Somanuals.com](http://www.Somanuals.com). All Manuals Search And Download.

Contents

<i>Controls</i>	2	<i>Recalling a preset station - DAB and FM</i>	18
<i>Battery operation</i>	3	<i>System reset</i>	19
<i>Mains operation</i>	3	<i>Headphone socket</i>	20
<i>Operating your radio - DAB</i>	4	<i>Line out socket</i>	20
<i>Selecting a station - DAB</i>	5	<i>Display backlight</i>	20
<i>Secondary services - DAB</i>	6	<i>Software version</i>	21
<i>Display modes - DAB</i>	7-8	<i>General</i>	22
<i>Finding new stations - DAB</i>	9	<i>Specifications</i>	23
<i>Signal strength display - DAB</i>	9	<i>Circuit features</i>	23
<i>Manual tuning - DAB</i>	10	<i>Mains Supply</i>	24
<i>Dynamic range control (DRC) settings - DAB</i>	11	<i>Notes</i>	25
<i>Station order setup - DAB</i>	12-13	<i>Guarantee</i>	26
<i>Operating your radio - FM</i>	14		
<i>Manual tuning - FM</i>	15		
<i>Display modes - FM</i>	16		
<i>FM stereo/mono</i>	16		
<i>Presetting stations - DAB and FM</i>	17		

Controls

(Top)

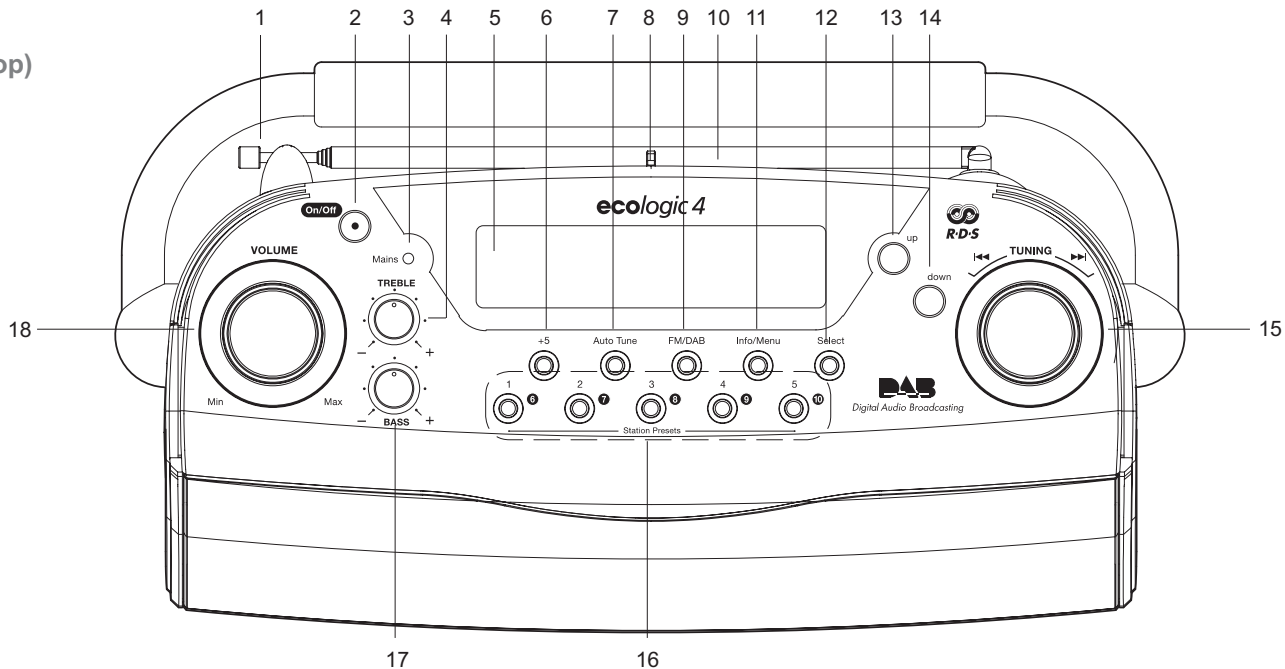

- | | | |
|---------------------------------|----------------------|------------------------|
| 1. Telescopic aerial (on rear) | 7. Auto Tune button | 13. Tuning Up button |
| 2. On/Off button | 8. Headphone socket | 14. Tuning Down button |
| 3. Mains LED indicator | 9. FM/DAB button | 15. Tuning control |
| 4. Treble control | 10. Line out socket | 16. Station presets |
| 5. Liquid crystal display (LCD) | 11. Info/Menu button | 17. Bass control |
| 6. + 5 button | 12. Select button | 18. Volume control |

Battery operation

1. Remove the **Battery cover** on the rear of the unit by pushing the battery door in and downwards.
2. Insert six LR20 (D size) batteries into the spaces in the compartment. Take care to ensure all batteries are inserted with the correct polarity as shown inside the battery compartment. Replace the battery cover.
3. Reduced power, distortion and a 'stuttering' sound are all signs that the batteries may need replacing.
4. If the radio is not to be used for any extended period of time it is recommended that the batteries are removed from the radio.

We would recommend for economy that the ecologic 4 is used on the mains whenever possible with battery operation for occasional or stand-by use only.

IMPORTANT: The batteries should not be exposed to excessive heat such as sunshine, fire or the like. After use, disposable batteries should if possible be taken to a suitable recycling centre. On no account should batteries be disposed of by incineration.

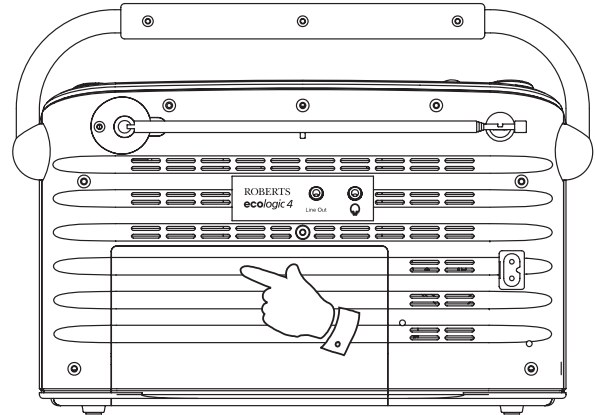

Mains operation

1. Place your radio on a flat surface.
2. Plug the mains lead into the **Socket** located on the rear of your radio ensuring that the plug is pushed fully into the socket.
3. Plug the other end of the mains lead into a wall socket and switch on the wall socket.

IMPORTANT: The mains plug is used as the means of connecting the radio to the mains supply. The mains socket used for the radio must remain accessible during normal use. In order to disconnect the radio from the mains completely, the mains plug should be removed from the mains socket outlet completely.

4. When the mains LED is on, it indicates that the radio is connected to and powered from the mains supply.

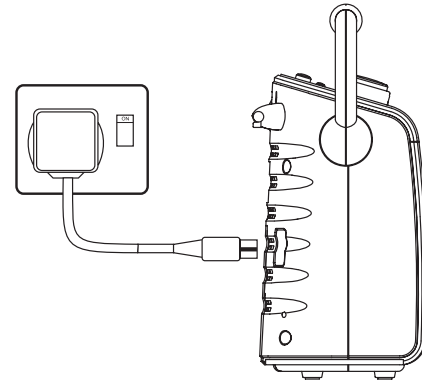

Operating your radio - DAB

1. Fully extend the telescopic aerial.
2. Press the **On/Off button** to switch on your radio. The display will show "Welcome to DAB" for a few seconds.
3. If this is the first time the radio is used a quick scan of the UK band III DAB channels will be carried out.
4. During Autotune as each group of stations is detected the bottom line of the display will show a bargraph indicating progress of the Autotune.
5. When the Autotune is complete the first station (in numeric-alpha order 0...9...A...Z) will be selected.
6. If the station list is still empty after the Autotune you radio will display "No stations available".
7. If no signals are found it may be necessary to relocate your radio to a position giving better reception.

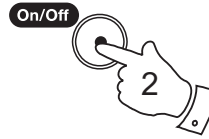

Welcome to DAB
■■■■■■■■■■

CAPITAL
Now tuning...

CAPITAL
Digital Network

No stations
available

Selecting a station - DAB

1. The top line of the display shows the name of the station currently selected.
2. Rotate the **Tuning control** or press the **Up** or **Down buttons** to scroll through the list of available stations.
3. Press and release the **Select button** to select the station. The display may show "Now Tuning" while your radio finds the new station.
4. Adjust the **Volume** and **Tone controls** to the required settings.

Note: If after selecting a station the display shows "Station not available" it may be necessary to relocate your radio to a position giving better reception.

Classic

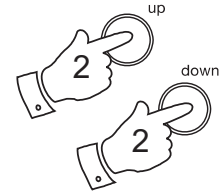
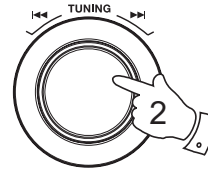

Classic FM
Now tuning...

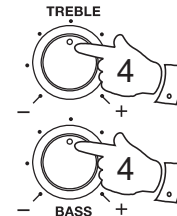
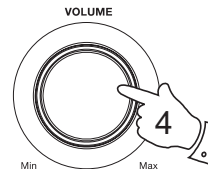

Secondary services - DAB

1. Certain radio stations have one or more secondary services associated with them. If a station has a secondary service associated with it the display will show ">>" next to the station name on the station list. The secondary service will then appear immediately after the primary service as you rotate the **Tuning control**.
2. To tune to the secondary service, press and release the **Select button**. Most secondary services do not broadcast continually and if the selected service is not available, the radio will retune to the associated primary service.

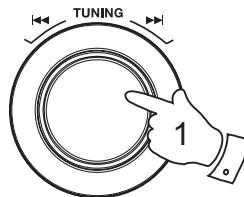

BBC Radio 5
◆ BBC 5 Live >> ◆

BBC Radio 5
◆ << BBC SportX ◆

Select



Display modes - DAB

Your radio has seven display modes:-

1. Press the **Info/Menu button** to cycle through the various modes.

Info/Menu



a. Scrolling text

Displays scrolling text messages such as artist/track name, phone in number etc.

a

BBC RADIO 7
Jane Jones Pres

b. Program Type

Displays the type of station being listened to e.g. Pop, Classic, News etc.

b

BBC RADIO 7
Varied Speech

c. Multiplex Name

Displays the name of DAB multiplex to which the current station belongs.

c

BBC RADIO 7
BBC National

d. Time and date

Displays current the time and date.

d

BBC RADIO 7
12:02 16-06-2007

e. Frequency Displays the frequency of the DAB multiplex for the station listened to.

e
BBC RADIO 7
12B 225.64MHz

f. Bit rate & audio type Displays the digital bit rate & audio type for the station being listened to.

f
BBC RADIO 7
160kbps Stereo

g. Signal Error Displays the signal error for the station being listened to.

g
BBC RADIO 7
Signal error 2

Finding new stations - DAB

As time passes new stations may become available. To find new stations proceed as follows:-

1. Press and release the **AutoTune button**, the display will show "Scanning". Your radio will perform a scan of the UK DAB frequencies. As new stations are found the station counter on the right-hand side of the display will increase and stations will be added to the list
2. To carry out a full scan of the entire DAB band (band III) press and hold down the **AutoTune button** for more than 2 seconds and then release. The display will show "Scanning". As new stations are found the station counter on the right-hand side of the display will increase and stations will be added to the list



Signal strength display - DAB

1. Press and release the **Select button** to switch between the current information display and the signal strength indication.
2. Position your radio and carefully angle the telescopic aerial for best reception using the signal strength display as a guide. Move your radio around and position so as to give maximum number of black rectangles on signal strength display. The clear unfilled rectangle indicates the minimum signal level required for satisfactory reception.



Manual Tuning - DAB

Manual tuning allows you to tune directly to the various band III DAB channels. UK DAB stations are currently located in the range 11B to 12D.

1. Press and hold down the **Info/Menu button** and rotate the **Tuning control** or press the **Up** or **Down buttons** until the display shows "Manual Tune". Press and release the **Select button**.
2. Rotate the **Tuning control** or press the **Up** or **Down buttons** to select the required DAB channel.
3. Press and release the **Select button**. The open block in the signal strength graph shows you the minimum signal strength needed for good DAB reception. The signal blocks will go up and down showing the changing signal strength as you adjust the telescopic aerial or the radio position.
4. Press and release the **Select button** to return to normal tuning mode.

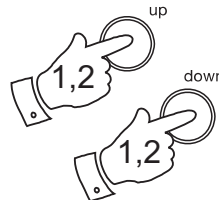
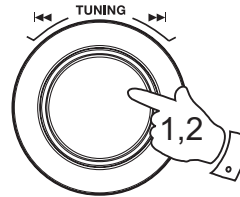
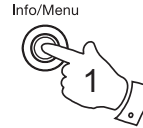

◆ ◆ or SELECT
◆ Manual tune ◆

◆ 5A 174.92MHz ◆

■■■■■
11D 222.06 MHz

Classic FM
Now tuning...

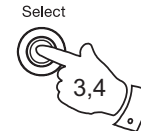

Dynamic Range Control (DRC) settings - DAB

The DRC facility can make quieter sounds easier to hear when your radio is used in a noisy environment.

1. Press the **On/Off button** to switch on your radio.
2. Press and hold down the **Info/Menu button** and rotate the **Tuning control** or press the **Up** or **Down buttons** until the display shows "DRC value". Press and release the **Select button** to enter adjustment mode.
3. Rotate the **Tuning control** or press the **Up** or **Down buttons** to select the required DRC setting (default is 0).

DRC 0 DRC is switched off, Broadcast DRC will be ignored.

DRC 1/2 DRC level is set to 1/2 that sent by broadcaster.

DRC 1 DRC is set as sent by broadcaster.

4. Press and release the **Select button** to confirm the setting. The display will return to normal tuning mode.

Note: Not all DAB broadcasts are able to use the DRC function. If the broadcast does not support DRC, then the DRC setting in the radio will have no effect.

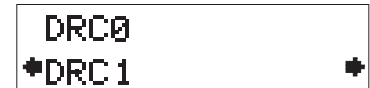
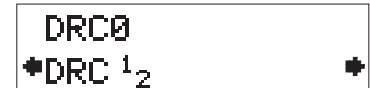
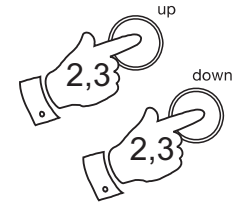
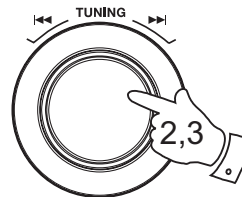

Station order setup - DAB

This function enables you to choose how the stations are arranged when selecting a station. There are four options available - favourite station, alphanumeric, active station and prune stations.

Note: Your radio default station order is numeric-alpha order.

1. Press and hold in the **Info/Menu button** and rotate the **Tuning control** or press the **Up** or **Down buttons** until "Station order" appears on the display.
2. Press and release the **Select button**.
3. Rotate the **Tuning control** or press the **Up** or **Down buttons** to choose between favourite station, alphanumeric, active station and prune stations.
4. Press and release the **Select button** to select the station order setting required.

Info/Menu

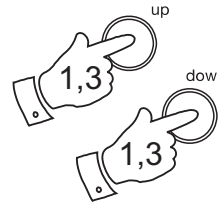
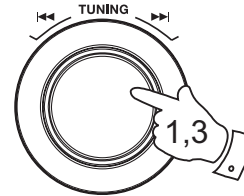

◆ ◆ or SELECT
◆ Station order ◆

Favourite stations

When this setting is switched on, after a period of time the most listened to stations will move to the top of the station list and will be marked with the heart symbol ♥.

Alphanumeric

Rotate the **Tuning control** until "Alphanumeric" appears on the display. Your radio will now select stations in alphanumeric order (0....9....A....Z).

Select



Alphanumeric
◆ Fav station ◆

Alphanumeric
◆ Alphanumeric ◆

Active station

When this setting is switched on the display will show only those that a signal can be found for.

Alphanumeric
◆Active station◆

Prune stations

Some DAB services may stop broadcasting or you may not be able to receive a station. Prune stations will delete the DAB stations from your station list that can no longer be received.

When this feature is selected your radio will delete the stations that are not currently being received.

Alphanumeric
◆Prune station◆

Operating your radio - FM

1. Carefully extend the telescopic aerial
2. Press the **On/Off button** to switch on your radio. The radio will tune to the last selected radio station.
3. Press the **FM/DAB button** to select the FM band.
4. Press and release the **Up button** then press the **Auto Tune button**. Your radio will search in an upwards direction (low frequency to high frequency) and stop automatically when it finds a station of sufficient strength.
5. If RDS information is being received, then after a few seconds the display will update and show the radio station name.
6. To find other stations press the **Auto Tune button** as before.
7. If you press and release the **Down button** then press the **Auto Tune button**, your radio will search in a downwards direction (high frequency to low frequency) and stop automatically when it finds a station of sufficient strength.
8. When the end of the waveband is reached your radio will recommence tuning from the opposite end of the waveband.
9. Adjust the **Volume** and **Tone controls** to the required settings.
10. To switch off your radio press the **On/Off button**.

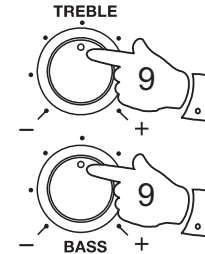
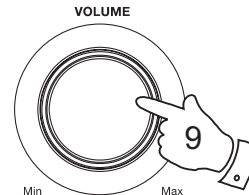
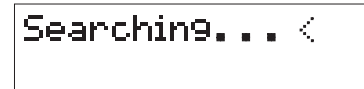
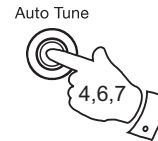
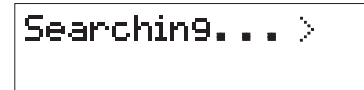
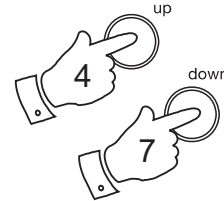

Manual tuning - FM

1. Press the **On/Off button** to switch on your radio.
2. Press and release the **FM/DAB button** to select the FM band. Fully extend the Telescopic aerial.
3. Rotate the **Tuning control** or press the **Up** or **Down buttons** to tune to a station. The frequency will change in steps of 50kHz.
4. When the end of the waveband is reached the radio will recommence tuning from the opposite end of the waveband.
5. Set the **Volume control** and **Tone controls** to the desired settings.
6. To switch off your radio press the **On/Off button**.

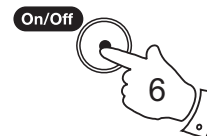
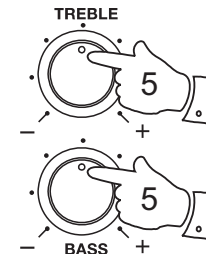
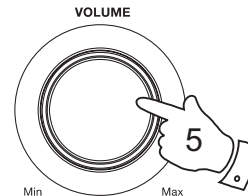
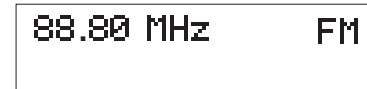
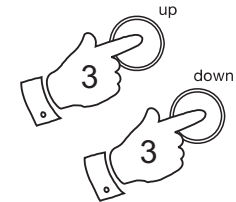
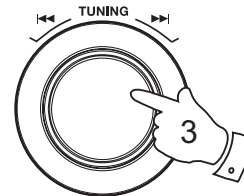
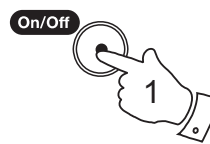

Display modes - FM

When listening in FM mode the bottom line of the display can be set to any of the following modes:-

1. Press the **Info/Menu button** to cycle through the various modes.

- | | |
|-------------------|--|
| a. Scrolling text | Displays scrolling text messages such as artist/track name, phone in number etc. |
| b. Program Type | Displays type of station being listened to e.g. Pop, Classic, News etc. |
| c. Time and date | Displays current time and date. |
| d. Frequency | Displays frequency of the station being listened to. |

Info/Menu



a

BBC R2	RDS
The latest news	

b

BBC R2	RDS
Pop Music	

c

BBC R2	RDS
12:02 16-06-2007	

d

BBC R2	RDS
88.10MHz	FM

FM Stereo/Mono

1. If the FM radio station being received is weak some hiss may be audible. To reduce the hiss press and release in the **Select button** until the display shows "Mono", your radio will switch to mono mode.
2. To return to stereo mode press and release in the **Select button** until the display shows "Auto", your radio will switch to stereo mode.

Select



BBC R2	St RDS
Mono	

BBC R2	St RDS
Auto	

Presetting stations - DAB and FM

There are 10 memory presets for each of the 2 wavebands.

1. Press the **On/Off button** switch on the radio.
2. Tune to the required station as previously described.
3. Press and hold down the required **Preset button** until the display shows e.g. Preset 1 saved. The station will be stored under the chosen preset button. Repeat this procedure for the remaining presets.
4. Presets 6 to 10 are obtained by pressing and holding **+5 button** together with the **Preset button 1 to 5**. e.g preset 7 can be set by pressing and holding **+5 button** together with **Preset button 2** until the display shows Preset 7 saved.
5. Stations stored in preset memories may be overwritten by following the above procedure.

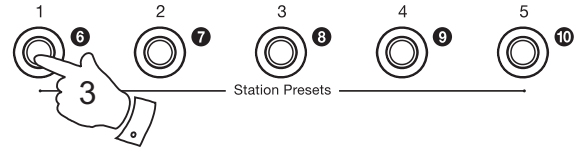
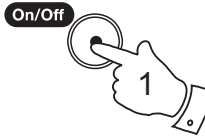

BBC R2
Preset 1 saved

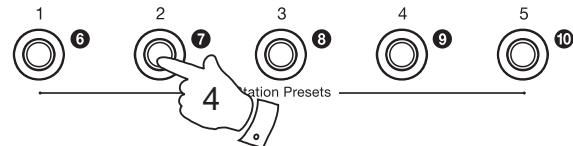

BBC R2
Preset 7 saved

Recalling a preset station - DAB and FM

1. Press the **On/Off button** to switch on the radio.
2. Select the required waveband by pressing the **FM/DAB button**.
3. Momentarily press the required **Preset button**, your radio will tune to the station stored in preset memory.
4. Presets 6 to 10 are obtained by pressing and holding **+5 button** and **Preset button 1 to 5**. e.g preset 7 can be recalled by pressing and holding **+5 button** followed by pressing **Preset button 2**.

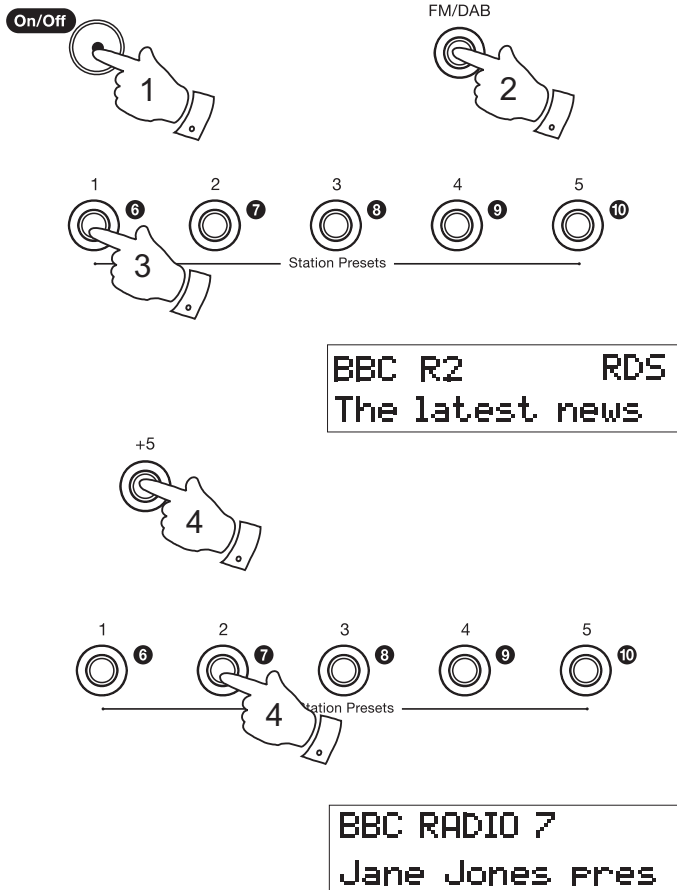

System reset

If your radio fails to operate correctly, or some digits on the display are missing or incomplete, if running on batteries first check that the batteries are not exhausted. If you still suspect a problem with your radio please carry out the following procedure.

1. In FM mode, press and hold down the **Info/Menu button** for 2 seconds. The display will show "SELECT Factory reset".
 2. In DAB mode, press and hold down the **Info/Menu button** and rotate the **Tuning control** or press the **Up** or **Down buttons** until the display shows "Select Factory reset".
 3. Press and release the **Select button** until the display shows "Press SELECT to confirm reset".
 4. Press **Select button** again to confirm system reset.
 5. A full reset will be performed all presets and station lists will be erased.
 6. After a system reset a scan of the DAB band will be performed.
- In case of malfunction due to electrostatic discharge, reset the product (reconnection of power source may be required) to resume normal operation.

If a problem persists our technical staff would be pleased to help offer any assistance on operating the radio. Our technical helpline number is 020 8758 0338.

Info/Menu



◆ ◆ or SELECT
◆ Factory reset ◆

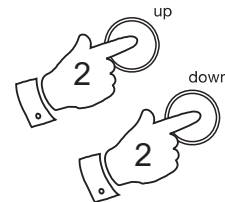
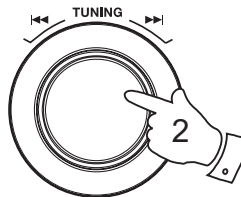

Select



Press SELECT to
confirm reset...

Software version

The software display cannot be altered and is just for your reference.

1. To view which software version your radio has press and hold in the **Info/Menu button**.
2. Rotate the **Tuning control** or the **Up** and **Down** buttons until the software version shows on the display.

Info/Menu

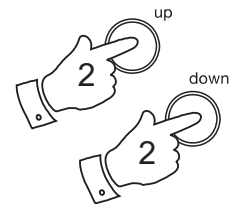
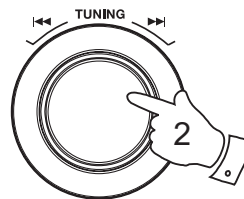

General

Do not allow this radio to be exposed to water, steam or sand. Do not leave your radio where excessive heat could cause damage such as in a parked car where the heat from the sun can build up even though the outside temperature may not seem too high. It is recommended that the DAB band be used wherever possible as better results in terms of quality and freedom from interference will usually be obtained than on the FM band.



- The radio should not be exposed to dripping or splashing and that no objects filled with liquids such as vases, shall be placed on the radio.
- It is recommended to operate the product such that there is a minimum distance (10cm recommended) to adjacent objects in order to ensure good ventilation.
- The ventilation of the product should not be restricted by covering it or its ventilation openings with items such as newspapers, table-cloths, curtains etc.
- No naked flame sources such as lighted candles should be placed on the product.
- It is recommended to avoid using or storing the product at extremes of temperature. Avoid leaving the unit in cars, on window sills in direct sunlight etc.
- The nameplate is located on the underside of your radio.

Specifications

Power Requirements

Mains	AC 230 volts, 50Hz  only
Batteries	6 x LR20 (D size)

Battery Life

Up to 150 hours of listening for 4 hours a day at normal volume using alkaline cells.

Frequency Coverage

FM	87.5-108MHz
DAB	174.928 - 239.200MHz

Circuit Features

Loudspeaker	2 x 79mm
Output Power	3W
Headphone socket	3.5mm dia
Line out socket	3.5mm dia
Aerial System	FM Telescopic aerial
	DAB Telescopic aerial

Mains supply

The radio will operate from a supply of AC 230 volts, 50Hz \sim only.

DO NOT cut off the mains plug from this equipment. If the plug fitted is not suitable for the power points in your home or the cable is too short to reach a power point, then obtain an appropriate safety approved extension lead or adaptor. If in doubt consult your dealer.

If nonetheless the mains plug is cut off, remove the fuse and dispose of the plug immediately to avoid a possible shock hazard by inadvertent connection to the mains supply.

If this product is not supplied with a mains plug, or one has to be fitted, then follow the instructions given below:

IMPORTANT

DO NOT make any connection to the larger terminal which is marked with the letter E or by the safety earth symbol \perp or coloured Green or Green-and-yellow.

The wires in the mains lead are coloured in accordance with the following codes :-

BLUE - NEUTRAL

BROWN - LIVE

The wire coloured BLUE must be connected to the terminal marked N or coloured BLACK.

The wire coloured BROWN must be connected to the terminal marked L or coloured RED.

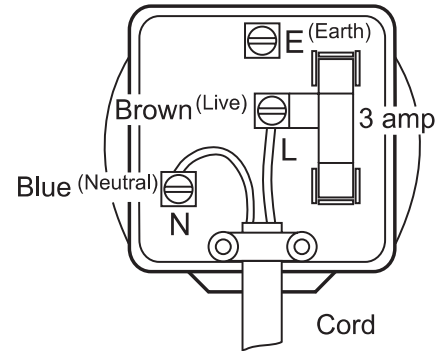

Fuse

When replacing the fuse only a 3A ASTA approved to BS1362 type should be used and be sure to re-fit the fuse cover.

IF IN DOUBT - CONSULT A QUALIFIED ELECTRICIAN.

Replacement fuse holders are available from Roberts Technical Services at the address shown on the rear of this manual.

Notes

Guarantee

This instrument is guaranteed for twelve months from the date of delivery to the original owner against failure due to faulty workmanship or component breakdown, subject to the procedure stated below. Should any component or part fail during this guarantee period it will be repaired or replaced free of charge.

The guarantee does not cover:

1. Damage resulting from incorrect use.
2. Consequential damage.
3. Receivers with removed or defaced serial numbers.

N.B. Damaged or broken telescopic aerials will not be replaced under guarantee.

Procedure:

Any claim under this guarantee should be made through the dealer from whom the instrument was purchased. It is likely that your Roberts' dealer will be able to attend to any defect quickly and efficiently, but should it be necessary the dealer will return the instrument to the company's service department for attention. In the event that it is not possible to return the instrument to the Roberts' dealer from whom it was purchased, please contact Roberts Radio Technical Services at the address shown on the rear of this manual.



Issue 1

ROBERTS RADIO TECHNICAL SERVICES

97-99 Worton Road

Isleworth Middlesex

TW7 6EG

Technical Helpline :- 020 8758 0338 (Mon-Fri during office hours)

Website: <http://www.robertsradio.co.uk>

© 2008 Roberts Radio Limited

Download from [Www.Somanuals.com](http://www.Somanuals.com). All Manuals Search And Download.



Free Manuals Download Website

<http://myh66.com>

<http://usermanuals.us>

<http://www.somanuals.com>

<http://www.4manuals.cc>

<http://www.manual-lib.com>

<http://www.404manual.com>

<http://www.luxmanual.com>

<http://aubethermostatmanual.com>

Golf course search by state

<http://golfingnear.com>

Email search by domain

<http://emailbydomain.com>

Auto manuals search

<http://auto.somanuals.com>

TV manuals search

<http://tv.somanuals.com>