

ROBERTS

Sound for Generations

R9974

3 Band PLL Synthesised Portable
Mains Battery Radio



Please read this manual before use

Contents

<i>Controls</i>	3-4
<i>Display</i>	5
<i>Battery operation</i>	6
<i>Using the AC adaptor</i>	6
<i>Setting the clock</i>	7
<i>Operating your radio</i>	8
<i>Scan tuning</i>	8
<i>Manual tuning</i>	9
<i>Search tuning</i>	10
<i>Storing stations in preset memories</i>	11
<i>Recalling preset stations</i>	12
<i>Setting the radio alarm</i>	13
<i>Setting the HWS buzzer alarm</i>	14
<i>Snooze function</i>	15
<i>Sleep function</i>	15
<i>Tuning step size</i>	16
<i>Display backlight</i>	17
<i>Headphone socket</i>	17
<i>General</i>	18
<i>Specifications</i>	18
<i>Circuit features</i>	18
<i>Guarantee</i>	19

Controls

(Top)

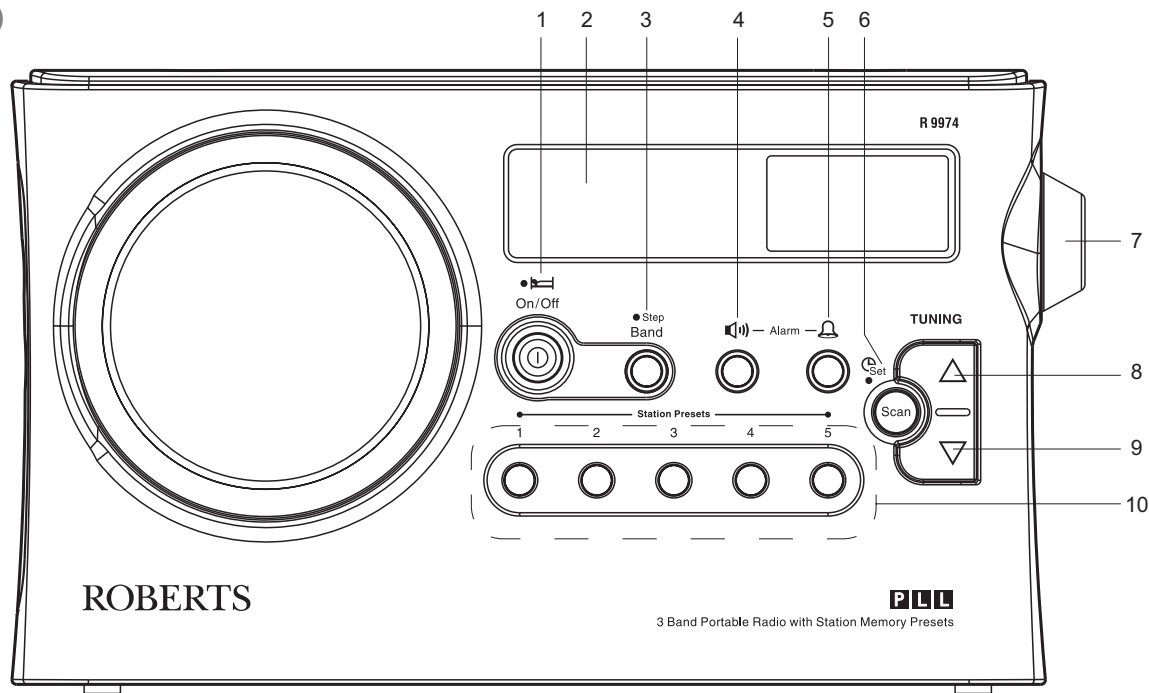

1. On/Off button
2. LCD display
3. Band/Step button
4. Radio alarm button
5. Buzzer alarm button
6. Scan/Time set button

7. Volume control
8. Tuning up button
9. Tuning down button
10. Preset buttons

Controls

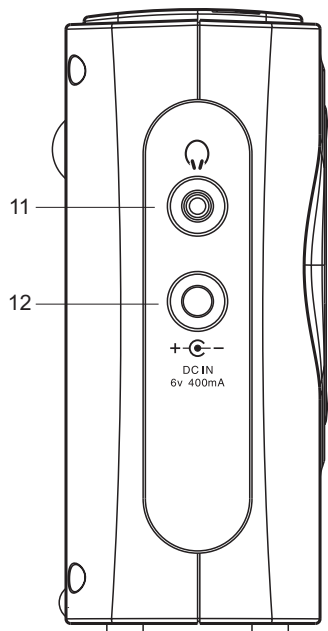

11. Headphone socket

12. DC input socket

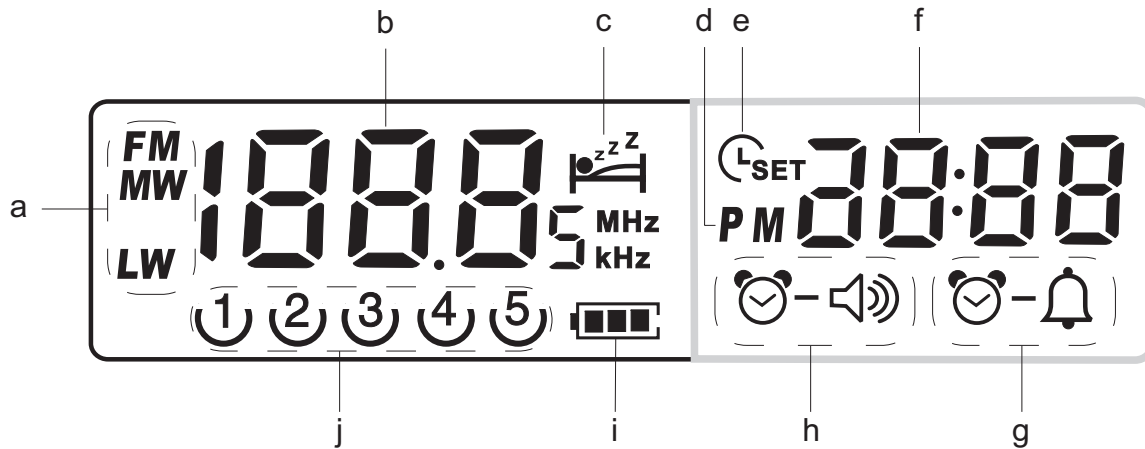

- a. Waveband indicators
- b. Frequency indicators
- c. Sleep/Snooze indicators
- d. PM indicator
- e. Time set indicator
- f. Time indicators
- g. Buzzer alarm indicators
- h. Radio alarm indicators
- i. Battery indicator
- j. Preset indicators

Battery operation

1. Release the catch securing the rear door of your radio.
2. Insert four LR20 (D size) batteries into the spaces in the compartment. Take care to ensure all batteries are inserted with the correct polarity as shown inside the battery compartment. Close the rear door and secure the catch
3. Reduced power, distortion, and a 'stuttering' sound are all signs that the batteries may need replacing. The batteries should be replaced when the battery indicator flashes and "E" shows in the display.
4. If the radio is not to be used for any extended period of time it is recommended that the batteries are removed from the radio.

We would recommend for economy that the R9974 is used via the AC adaptor whenever possible with battery operation for occasional or stand-by use only.

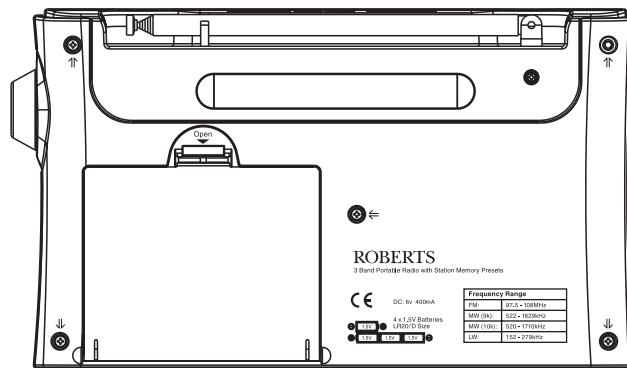

Using the AC adaptor

1. Insert the adaptor plug into the DC in socket on the left hand side of your radio.
2. Plug the adaptor into a standard 13A mains socket outlet. Whenever the adaptor is used the batteries are automatically disconnected.

The AC adaptor should be disconnected from the mains supply and the radio when not in use. The unit is only fully isolated from the mains if the AC adaptor is removed from the wall socket.

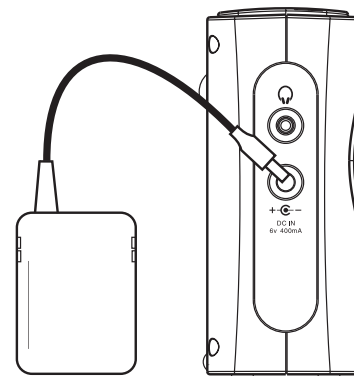

Setting the clock

1. The clock will start running when the batteries are installed or when the radio is connected to the mains supply. The display will show "-:--" together with the real time symbol .
2. The time can be set with your radio switched on or off.
3. Press and hold down the **Time set button** until the hours digits flash in the display.
4. Press the **Tuning up/down** buttons to set the required hour.
5. Press the **Time set button**, the minute digits will flash in the display.
6. Press the **Tuning up/down** buttons to set the required minute.
7. Press the **Time set button** to complete time setting. The colon between the hour and minute digits will begin to flash.

TUNING

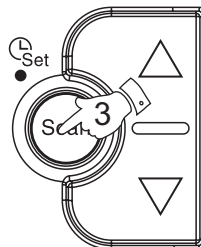

TUNING

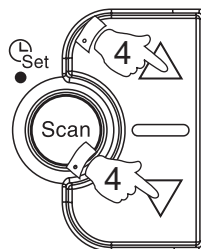

TUNING

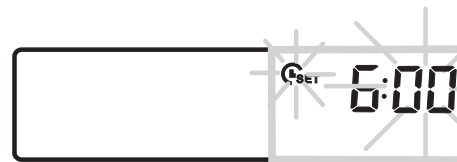
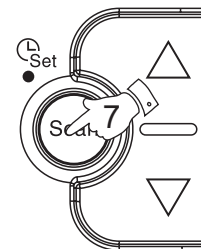

Operating your radio

Your radio is equipped with four tuning methods:- Scan tuning, Manual tuning, Search tuning and Memory preset tuning.

Scan tuning

1. Press the **On/Off button** to switch on your radio.
2. Select the required waveband by repeatedly pressing the **Band** button. For the FM waveband fully extend the **Telescopic aerial** and set it at an angle of 45 degrees.
3. Press and release the **Scan button** to commence scan tuning.
4. The radio will scan the selected waveband and stop automatically when it finds a station of sufficient strength. Press the **Scan button** to listen to the station.
*Note: your radio will continue to search for the next available station if you do not press the **Scan button** when it finds a radio station.*
5. When the waveband end is reached the radio will continue tuning from the opposite waveband end.
6. Set the **Volume control** clockwise to the required level.
7. To switch off your radio press the **On/Off button**. The display will show **OFF**.

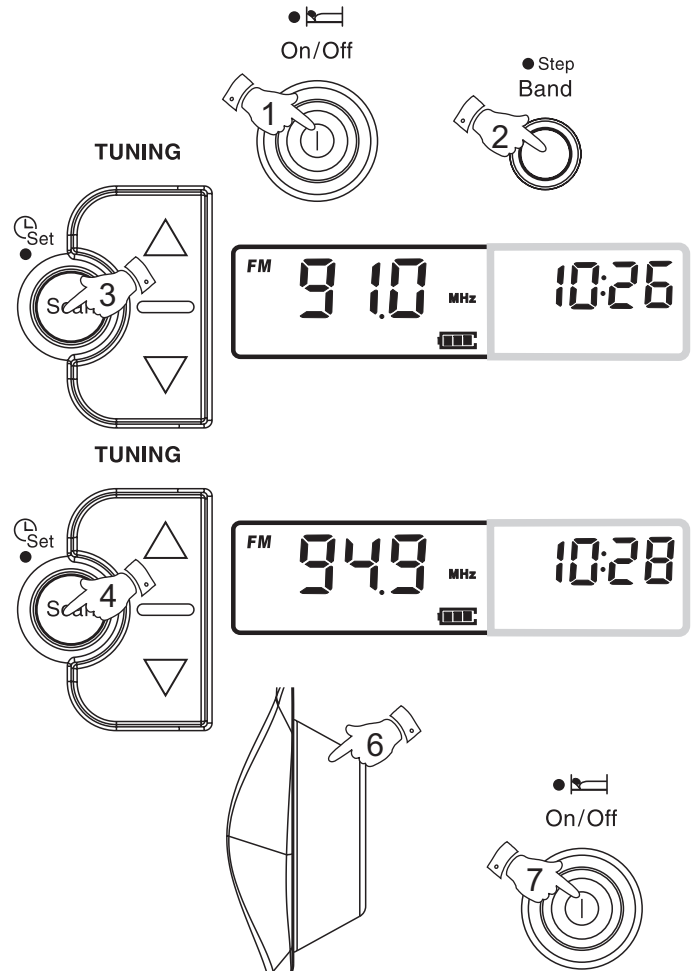

Manual tuning

1. Press the **Power button** to turn on the radio.
2. Select the required waveband by repeatedly pressing the **Band** button. For the FM waveband fully extend the **Telescopic aerial** and set it at an angle of 45 degrees.
3. A single press on either the **Tuning up** or **Tuning down** buttons will change the frequency in the following increments:-

FM	50 or 100kHz
MW	9 or 10 kHz
LW	3kHz
4. When the waveband end is reached the radio will continue tuning from the opposite waveband end.
5. Set the **Volume control** clockwise to the required level.
6. To switch off your radio press the **On/Off button**. The display will show **OFF**.

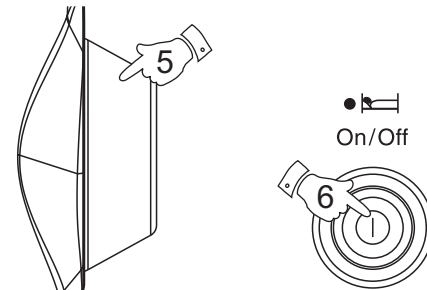
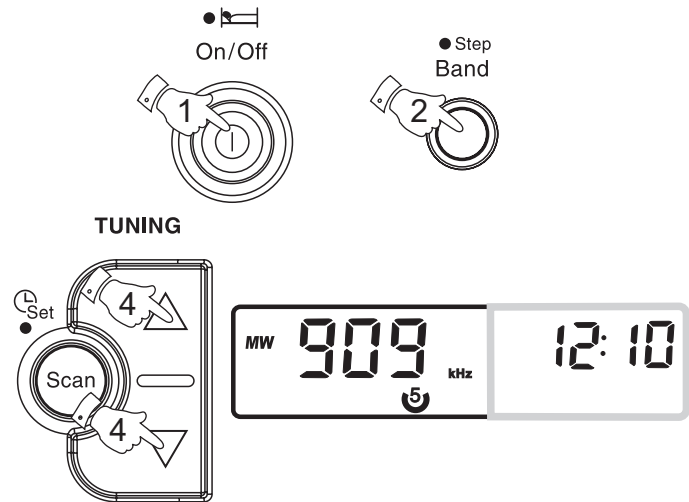

Search tuning

1. Press the **Power button** to turn on the radio.
2. Select the required waveband by repeatedly pressing the **Band** button. For the FM waveband fully extend the **Telescopic aerial** and set it at an angle of 45 degrees.
3. Press and hold down either the **Tuning up** or **Tuning down** buttons for more than 0.5 sec to commence scan tuning.
4. The radio will scan the selected waveband and stop automatically when it finds a station of sufficient strength.
5. To recommence scan tuning, press and hold down either the **Tuning up** or **Tuning down** buttons for more the 0.5 sec.
6. When the waveband end is reached the radio will continue tuning from the opposite waveband end.
7. Set the **Volume control** clockwise to the required level.
8. To switch off your radio press the **On/Off button**. The display will show OFF.

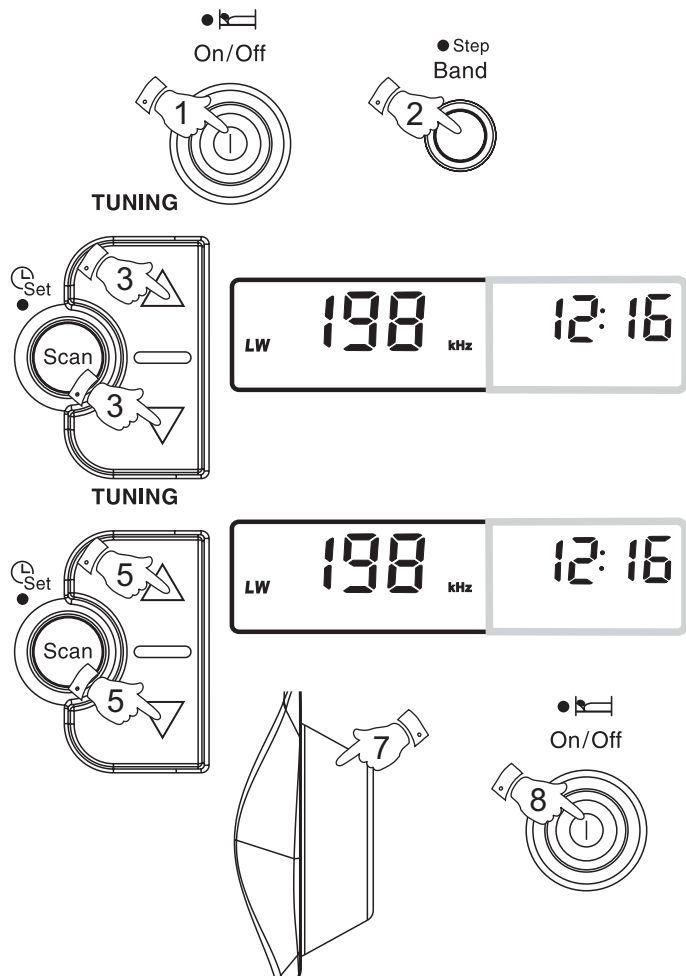

Storing stations in preset memories

There are 5 memory presets for each waveband.

1. Press the **Power button** to turn on the radio.
2. Tune to the required station using one of the methods previously described.
3. Press and hold down the required preset until the radio beeps (greater than 2 seconds) The preset number will appear in the display and the station will be stored under the chosen preset button.
4. Repeat this procedure for the remaining presets.
5. Stations stored in preset memories may be overwritten by following the above procedure.

On/Off

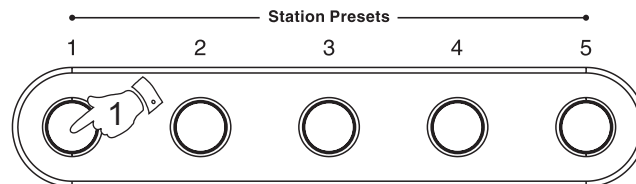
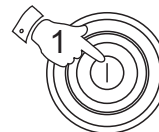

Recalling preset stations

1. Press the **Power button** to turn on the radio.
2. Select the required waveband by repeatedly pressing the **Band** button.
3. Momentarily press the required **Preset button**, the preset number and station frequency will appear in the display.

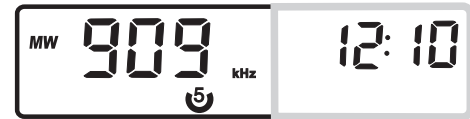
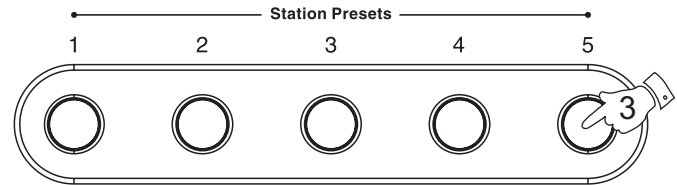
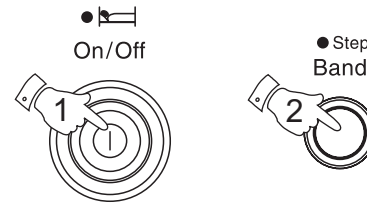

Setting the radio alarm

When the radio alarm is selected the radio will turn on and play the station selected during the alarm set up. The radio alarm will sound for one hour unless turned off by pressing the **Power button**. Pressing the **Power button** whilst the alarm is sounding will cancel the alarm for 24 hours.

1. The radio alarm time can be set with the radio switched on or off.
2. Press and hold down the **Radio Alarm button** immediately press and hold down the **Time set button** until the hour digits and radio alarm symbol flash in the display.
3. Set the required hour using the **Tuning up/down buttons**.
4. Press the **Time set button**, the minute digits will flash in the display.
5. Set the required minute using the **Tuning up/down buttons**.
6. Select the station you wish to wake up to using the **Waveband** and **Tuning up/down buttons**.
7. Press the **Time set button** to complete alarm setting.
8. To permanently cancel the alarm press and hold down the **Radio Alarm button** until the radio alarm symbol is removed from the display. The alarm may be re-activated to a previously set time by pressing and holding down the **Radio Alarm button** until the radio alarm symbol appears in the display.

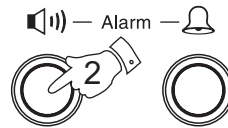

TUNING

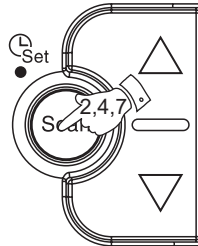

TUNING

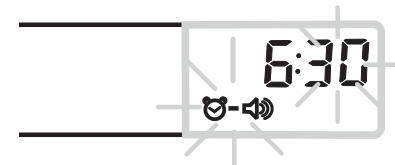
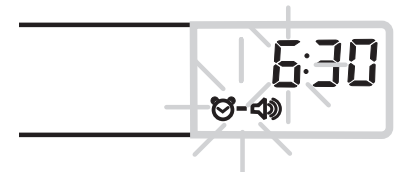
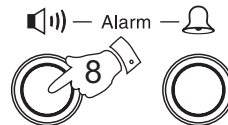
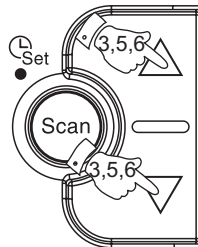

Setting the HWS (Humane Wake System) buzzer alarm

A beep tone will sound when using the HWS alarm. The alarm beep will increase in volume every 15 seconds for one minute followed by one minutes silence before repeating the cycle. The HWS alarm will sound for one hour unless turned off by pressing the **On/Off button**. Pressing the **On/Off button** whilst the alarm is sounding will cancel the alarm for 24 hours.

1. The HWS buzzer alarm time can be set with the radio switched on or off.
2. Press and hold down the **Buzzer Alarm button** immediately press and hold down the **Time set button** until the hour digits and radio alarm symbol flash in the display.
3. Set the required hour using the **Tuning up/down buttons**.
4. Press the **Time set button**, the minute digits will flash in the display.
5. Set the required minute using the **Tuning up/down buttons**.
6. Press the **Time set button** to complete alarm setting.
7. To permanently cancel the alarm press and hold down the **Buzzer Alarm button** until the radio alarm symbol is removed from the display. The alarm may be re-activated to a previously set time by pressing and holding down the **Buzzer Alarm button** until the buzzer alarm symbol appears in the display.

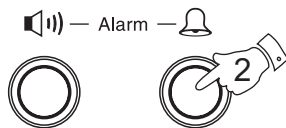

TUNING

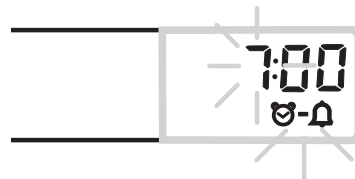
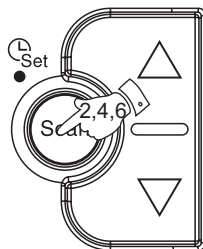

TUNING

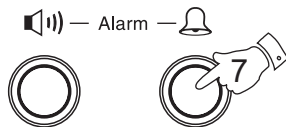
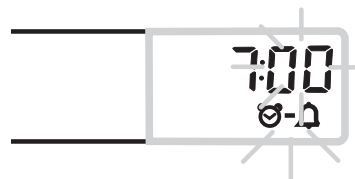
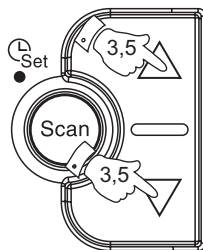

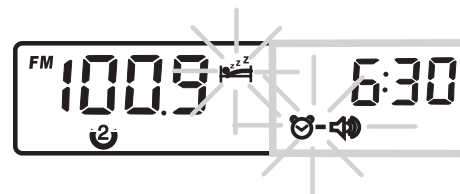

Snooze function

1. Whilst the alarm is sounding pressing any button (except the **Power button**) will activate the snooze function. The Radio or Buzzer alarms will be silenced for 5 minutes.
2. The Display will flash both the snooze symbol and the alarm symbol . The snooze function can be repeated during the 1 hour that the alarms are active.



Sleep function

The sleep timer will automatically switch off your radio after a preset time has elapsed.

1. Press and continue to hold down the **On/Off button** the display will cycle through the available sleep times in the order 60-45-30-15-120-90-60. Release the button when the required sleep time appears in the display. The  symbol will appear in the display and the radio will play the last station selected.
2. To cancel the sleep function, press the **On/Off button**, the  symbol will disappear and the radio will switch off.

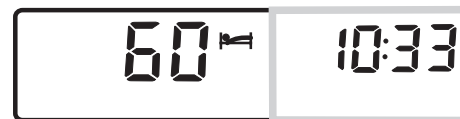
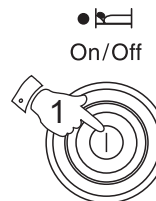

Tuning step size

In Europe and other parts of the world MW tuning steps are 9kHz, in America the MW tuning step size is 10kHz.

On FM tuning steps can be set to either 50 or 100kHz.

1. Ensure that your radio is switched off.
2. Press and hold down the **Step/Band button** for 2 sec. The display will show the current FM step size. Continue holding down the **Step/Band button** for 5 sec. Your radio will beep and the display will flash FM and 50kHz.
3. Press the **Tuning Up button** to change FM step size to 100kHz.
4. Press the **Tuning Down button** to change FM step size to 50kHz.
5. Press the **Step/Band button** to display the MW step size. The display will show MW and flash 9kHz.
6. Press the **Tuning Up button** to change MW step size to 10kHz.
7. Press the **Tuning Down button** to change MW step size to 9kHz.
8. Complete the setting by pressing the **Step/Band button**.



TUNING

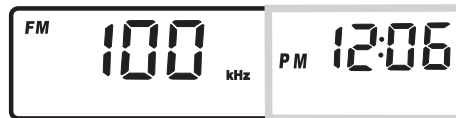
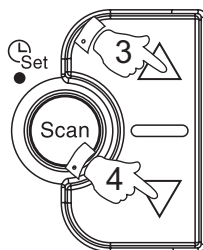

TUNING

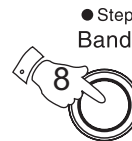
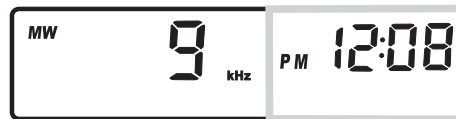
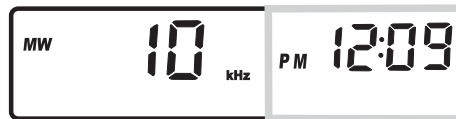
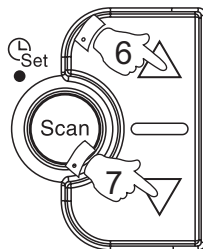

Display backlight

1. The display backlight will be switched on for approximately 15 seconds when any button is pressed, during station scanning and when the alarm is operating.

Headphone socket

1. A 3.5mm Headphone Socket located on the left hand side of your radio is provided for use with either headphones or an earpiece. Inserting a plug automatically mutes the internal loudspeaker.

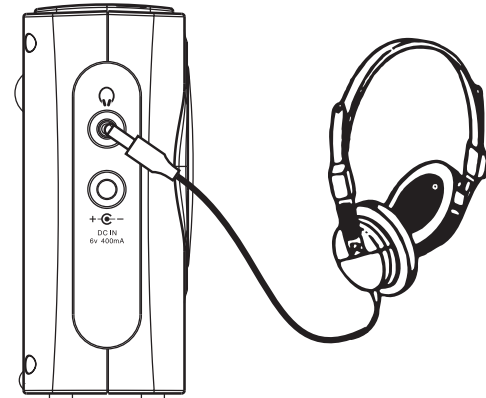

General

Do not allow this radio to be exposed to water, steam or sand. Do not leave your radio where excessive heat could cause damage such as in a parked car where the heat from the sun can build up even though the outside temperature may not seem too high. It is recommended that the FM band be used wherever possible as better results in terms of quality and freedom from interference will usually be obtained than on the MW or LW bands.

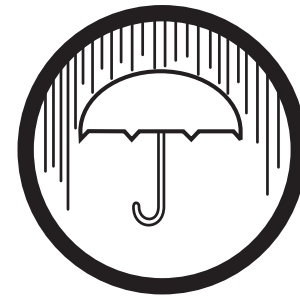
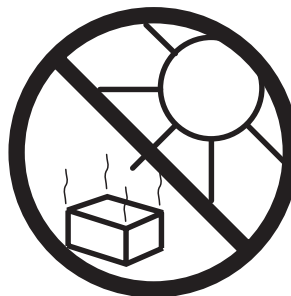

Specifications

Power Requirements

Mains (via AC adaptor)

AC 230 volts, 50Hz  only/DC 6V 400mA

Batteries

4 x LR20 (D size)

Battery Life

Approx. 170 hours of listening for 4 hours a day at normal volume using alkaline cells.

Frequency Coverage

FM	87.5-108MHz
MW	522-1629kHz
LW	153-279kHz

Circuit Features

Loudspeaker

75mm 4ohm full range

Output Power

800mW

Headphone socket 3.5mm dia

Aerial System

FM Telescopic aerial

MW/LW Ferrite Rod

Guarantee

This instrument is guaranteed for twelve months from the date of delivery to the original owner against failure due to faulty workmanship or component breakdown, subject to the procedure stated below. Should any component or part fail during this guarantee period it will be repaired or replaced free of charge.

The guarantee does not cover:

1. Damage resulting from incorrect use.
2. Consequential damage.
3. Receivers with removed or defaced serial numbers.

N.B. Damaged or broken telescopic aerials will not be replaced under guarantee.

Procedure:

Any claim under this guarantee should be made through the dealer from whom the instrument was purchased. It is likely that your Roberts' dealer will be able to attend to any defect quickly and efficiently, but should it be necessary the dealer will return the instrument to the company's service department for attention. In the event that it is not possible to return the instrument to the Roberts' dealer from whom it was purchased, please contact Roberts Radio Technical Services at the address shown on the rear of this manual.

These statements do not affect the statutory rights of a consumer.



Issue 2

ROBERTS RADIO TECHNICAL SERVICES

97-99 Worton Road

Isleworth Middlesex

TW7 6EG

Technical Helpline :- 020 8758 0338 (*Mon-Fri during office hours*)

Website: <http://www.robertsradio.co.uk>



Free Manuals Download Website

<http://myh66.com>

<http://usermanuals.us>

<http://www.somanuals.com>

<http://www.4manuals.cc>

<http://www.manual-lib.com>

<http://www.404manual.com>

<http://www.luxmanual.com>

<http://aubethermostatmanual.com>

Golf course search by state

<http://golfingnear.com>

Email search by domain

<http://emailbydomain.com>

Auto manuals search

<http://auto.somanuals.com>

TV manuals search

<http://tv.somanuals.com>