



Bluetooth Wireless Speaker | RF-SPX15

USER GUIDE



Contents

Important safety instructions.....	3
Features	4
Package contents.....	4
Front	5
Back.....	7
Connecting your speaker.....	8
Charging the battery	8
Connecting your speaker using Bluetooth.....	9
Connecting your speaker using the LINE IN jack.....	9
Using your speaker.....	10
Turning your speaker on or off.....	10
Playing music	10
Using the phone feature	11
Switching between paired devices	11
Disconnecting your speaker from a Bluetooth device.....	12
Resetting your speaker	12
Specifications	12
Troubleshooting.....	13
Frequently asked questions (FAQ)	15
Legal notices.....	16
One-year limited warranty	17

Important safety instructions

- 1 Read these instructions.
- 2 Keep these instructions.
- 3 Heed all warnings.
- 4 Follow all instructions.
- 5 Do not use this apparatus near water.
- 6 Clean only with dry cloth.
- 7 Do not block any ventilation openings. Install in accordance with the manufacturer's instructions.
- 8 Do not install near any heat sources such as radiators, heat registers, stoves, or other apparatus (including amplifiers) that produce heat.
- 9 Do not defeat the safety purpose of the polarized or grounding-type plug. A polarized plug has two blades with one wider than the other. A grounding type plug has two blades and a third grounding prong. The wide blade or the third prong are provided for your safety. If the provided plug does not fit into your outlet, consult an electrician for replacement of the obsolete outlet.
- 10 Protect the power cord from being walked on or pinched particularly at plugs, convenience receptacles, and the point where they exit from the apparatus.
- 11 Only use attachments/accessories specified by the manufacturer.
- 12 Use only with the cart, stand, tripod, bracket, or table specified by the manufacturer, or sold with the apparatus. When a cart is used, use caution when moving the cart/apparatus combination to avoid injury from tip-over.
- 13 Unplug this apparatus during lightning storms or when unused for long periods of time.
- 14 Refer all servicing to qualified service personnel. Servicing is required when the apparatus has been damaged in any way, such as power-supply cord or plug is damaged, liquid has been spilled or objects have fallen into the apparatus, the apparatus has been exposed to rain or moisture, does not operate normally, or has been dropped.
- 15 To reduce the risk of fire or electric shock, do not expose this device to rain, moisture, dripping, or splashing, and no objects filled with liquids, such as vases, shall be placed on it.



- 16 An apparatus with a three-prong, grounding-type plug is a Class I apparatus, which needs to be grounded to prevent possible electric shock. Make sure that you connect this Class I device to a grounding-type, three-prong outlet.
- 17 The wall plug is the disconnecting device. The plug must remain readily operable.
- 18 Batteries should not be exposed to excessive heat such as sunshine, fire, or the like.

Caution: *Danger of explosion if battery is incorrectly replaced. Replace only with the same or equivalent type.*

Features

- Full range stereo audio and powerful bass enhancement
- Up to 10 hours of battery life (480 hours of standby)
- 33' (10 m) range
- Call waiting
- 2-color LED indicates charging and pairing
- Ambient noise reduction
- Compatible with most Bluetooth-enabled handsets and mobile phones
- Stores up to eight paired devices

Note: *You can only connect to one paired device at a time.*

Package contents

- Bluetooth Wireless Speaker
- USB charging cable
- AC adapter
- Carrying case
- *Quick Setup Guide*

Front

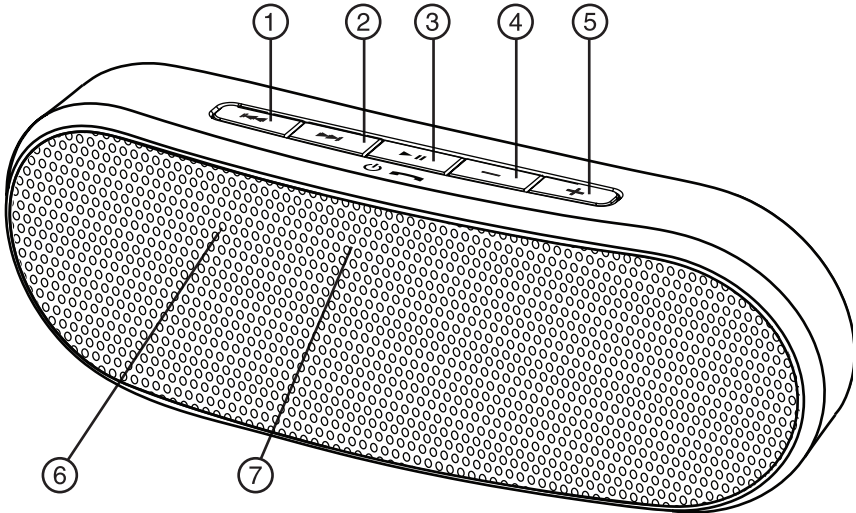

#	Component	Description
1	⏮ (previous)	<p>When listening to music:</p> <ul style="list-style-type: none"> • Press to go to the beginning of the current track or to the previous track, depending on how long the track has been playing. • Press and hold to fast reverse. <p>When on a phone call:</p> <ul style="list-style-type: none"> • Press to unmute the microphone.
2	⏭ (next)	<p>When listening to music:</p> <ul style="list-style-type: none"> • Press to go to the next track. • Press and hold to fast forward. <p>When on a phone call:</p> <ul style="list-style-type: none"> • Press to mute the microphone.

#	Component	Description
3	 (multi-function)	<ul style="list-style-type: none"> • Press and hold for three seconds to turn your speaker on. Your speaker beeps, and the LED indicator lights blue. • Press and hold for three seconds to turn your speaker off. Your speaker beeps, and the LED indicator turns off. • When listening to music, press to start or pause playback. • When your speaker is turned off, press and hold for five seconds to enter pairing mode. • When the phone is ringing, press to answer the phone. • Press to end a phone call. • When the phone is ringing, double-press to reject the phone call. • Press and hold for two seconds to switch a phone call between the phone and the speaker.
4	— (volume down)	Press to decrease the speaker volume.
5	+ (volume up)	Press to increase the volume.
6	Microphone	Speak into the microphone when you are using your speaker to talk on the phone. <ul style="list-style-type: none"> • LED OFF: Your speaker is turned off. • Blue: <ul style="list-style-type: none"> • Your speaker is turned on and the microphone is not muted. • If the charging cable is connected, the battery is fully charged. • Red: Battery power level is low. • Flashing blue/red: Your speaker is in pairing mode. • Flashing red: Battery power is almost drained. • Flashing blue: <ul style="list-style-type: none"> • The battery is recharging. • Your speaker is not currently connected to a device and is searching for a paired device. • Flashing blue/red/off: The microphone is muted.
7	LED indicator	

Back

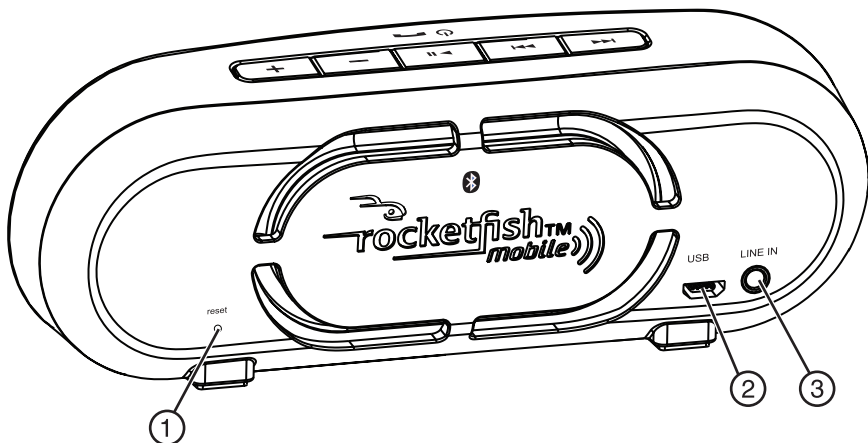

#	Component	Description
1	reset button	<ul style="list-style-type: none"> Insert a paperclip into the reset hole to press the reset button inside the hole. Your speaker turns off and resets.
2	USB charging connector	<ul style="list-style-type: none"> Connect the USB charging cable to this connector and to a USB power adapter or USB port on a computer to charge the battery.
3	LINE IN jack	<ul style="list-style-type: none"> Connect an audio device, such as an MP3 player, to this jack using a 3.5mm audio cable.

Connecting your speaker

Charging the battery

Before using your speaker, you need to charge it for about four hours. When the battery is fully charged, it provides up to 10 hours of music playback and up to 720 hours of standby time.

The LED flashes blue while the battery is charging. When the battery is fully charged, the LED lights solid blue.

To charge the battery:

- Connect one end of the USB charging cable into the USB port on your speaker and the other end into the USB port on the AC adapter. Plug the AC adapter into a power outlet.

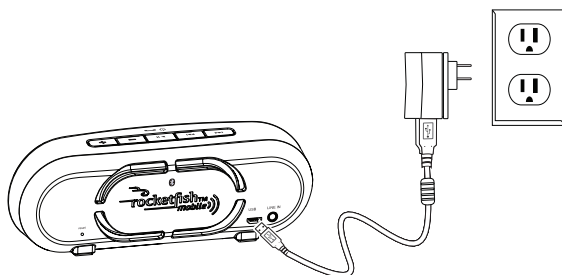

OR

- Connect one end of the USB charging cable into the USB port on your speaker and the other end into an open USB port on a computer.

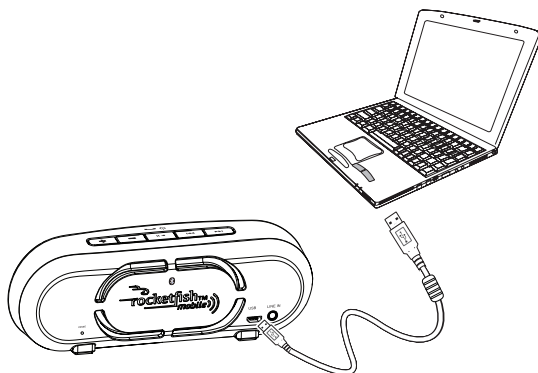

Connecting your speaker using Bluetooth

Before you can use your speaker with a Bluetooth device, you need to pair your speaker and the device.

To connect your speaker using Bluetooth:

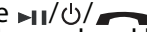
- 1 Make sure that a compatible Bluetooth device (like a music player or phone) is turned on and within 33 feet (10 meters) of your speaker.
- 2 Make sure that your speaker's battery is fully charged, and your speaker is turned off.
- 3 Press and hold the  button for five seconds until the LED indicator flashes red and blue. Your speaker is in pairing mode.
- 4 Activate pairing mode on your Bluetooth device, then set the device to start searching. If you are unsure about how to activate pairing mode on your device, see the documentation that came with the device.
- 5 On the Bluetooth device, select **RF-SPX15** in the list of found devices.
- 6 On the Bluetooth device, enter **0000** as the PIN, if prompted. Your speaker beeps twice and the LED indicator lights blue.
- 7 If you are pairing with a computer, make sure that your speaker is selected as the computer's default playback device. See the computer's documentation for instructions.

Connecting your speaker using the LINE IN jack

To connect your speaker using the LINE IN jack:

- Connect a 3.5mm audio cable (not provided) to the **LINE IN** jack on the back of your speaker and to the audio out jack on an audio device, such as an MP3 player.



When your speaker is connected to a device using the **LINE IN** jack:

- If you connect a paired Bluetooth device, such as a phone, to the **LINE IN** jack, you can answer or make phone calls while listening to music. When a phone call is in progress, the device connected the **LINE IN** jack stops playing music.
- You must use the connected device to control music playback.

Using your speaker

Turning your speaker on or off

To turn your speaker on or off:



- Press and hold the  button for three seconds. Your speaker turns on and beeps, and the LED indicator lights blue.
- Press and hold the  button for three seconds. Your speaker beeps and turns off, and the LED indicator also turns off.

Playing music

For optimum audio:

- Make sure that your speaker is sitting upright and facing forward.
- If you connect your speaker to a device using Bluetooth, turn the volume up on the connected device, then use the volume controls on your speaker to adjust the volume.
- If you connect your speaker to a device using the **LINE IN** jack and the audio is distorted, reduce the volume on the connected device, then use the volume controls on your speaker to adjust the volume.

To play music from a paired Bluetooth music device:

- Press the  button to start or pause playback.
- Press the  button to go to the next track. Press and hold the button to fast forward.
- Press the  button to go to the beginning of the current track or to the previous track, depending on how long the current track has been playing. Press and hold the button to fast reverse.
- Press the + button to increase the volume, or press the – button to decrease the volume.







To play music from a device connected to the LINE IN jack:

- 1 If the device connected to the **LINE IN** jack is also connected using Bluetooth, disconnect from Bluetooth.
- 2 Use the controls on the connected device to start and control music playback.

Using the phone feature

Your speaker has a built-in microphone that works like a speakerphone. When your speaker is connected to a phone using Bluetooth, face the front of your speaker and speak.

To use the phone feature:

- Press the  button when the phone is ringing to answer the phone call. Press this button again to end the call.
- Double-press the  button when the phone is ringing to reject the phone call.
- Press the  button when music is playing to redial the last outgoing phone call.
- Press and hold the  button for two seconds to switch a phone call from the phone to the speaker.
- Press the + button to increase the volume, or press the – button to decrease the volume.
- Press the  button to mute the microphone. Press the  button to unmute the microphone.

Switching between paired devices

To switch between paired devices:

- 1 Disconnect from the device that your speaker is connected to. The blue LED begins to flash slowly.
- 2 On the Bluetooth device you want to use, select **RF-SPX15** to connect to your speaker.

Disconnecting your speaker from a Bluetooth device

To disconnect your speaker from a Bluetooth device, do one of the following:

- Turn off your speaker.
- Disconnect your speaker in the device's Bluetooth menu.
- Move your speaker more than 33 feet (10 meters) away from the Bluetooth device.

Note: You do not need to delete the pairing information to disconnect your speaker. When you reconnect your speaker, you will not be asked for the PIN again.

If you want to pair your speaker with new Bluetooth devices, you do not need to erase all paired device information.

Resetting your speaker

To reset your speaker:

- Insert a paperclip into the reset hole to press the reset button inside the hole. Your speaker turns off and resets.

Note: Resetting your speaker does not erase pairing information.

Specifications

Total Power (Watts RMS)	6W
Audio Frequency Response	200Hz ~ 16kHz/+/-5dB
Connectors	3.5mm Stereo Plug USB mini-B plug
Bluetooth V2.1 + EDR	AZDP, AVRCP, HFP, HSP
Bluetooth Profile needed	HFP/HSP/A2DP/AVRCP
Talk time	Up to 10 hours
Standby time	Up to 480hours
AC to DC Charger input voltage	100~240AC
AC to DC charger output voltage	5V
Dimensions	2.3 × 6.4 × 1.6" (5.9 × 16.3 × 4.2 cm)

Troubleshooting

Problem	Possible solution
No sound	<ul style="list-style-type: none"> • Make sure your speaker and the device are both turned on. • Turn up the volume on your device and on your speaker. • Make sure your device is not muted. • Make sure music is playing on the device. • Make sure that your speaker is within 33 feet (10 meters) of the device. • Make sure your speaker's battery is fully charged. • If your speaker is paired with another device, such as a smartphone, disconnect it from that device. Your speaker can only connect to one Bluetooth device at a time. • On the Bluetooth device, make sure that RF-SPX15 is selected. • If your speaker is paired to a computer, make sure that RF-SPX15 is the selected as the default Playback and Recording Device (Windows computers) or Out put and Input Device (MAC computers). • Try re-pairing your speaker. See "Connecting your speaker using Bluetooth" on page 9. • Make sure that the connected device has internal and external speaker settings that turn off the internal speakers so the audio can be sent to an external source (your speaker).
Distorted audio	<ul style="list-style-type: none"> • Lower the volume on your speaker or the device. • Your speaker may be too far from the device. Make sure that your speaker is within 33 feet (10 meters) of the device. • Make sure your speaker's battery is fully charged. • Another device, such as a cordless phone, microwave, or wireless router, may be causing interference. Try turning off one device at a time to determine which device is causing interference. If a cordless phone or wireless router is causing interference, try changing the channel the device is using. See the documentation that came with the device for instructions.
Volume is too low	<ul style="list-style-type: none"> • Make sure the volume on the connected device is turned up to at least 50% of its volume level. • Make sure your speaker's battery is fully charged. • Connect your speaker to the audio out jack on the device using a 3.5mm audio cable.
Cannot pair with a Bluetooth device	<ul style="list-style-type: none"> • Make sure that your phone or device is Bluetooth-compatible. • Try re-pairing the speaker. See "Connecting your speaker using Bluetooth" on page 9.
Bluetooth signal fades or drops out	<ul style="list-style-type: none"> • Move your speaker closer to the device. • Make sure your speaker's battery is fully charged. • Turn off your speaker and device, then turn them back on and reconnect.

Problem	Possible solution
<p>My speaker will not turn on</p>	<ul style="list-style-type: none"> • Your speaker turns off when the battery charge is low. Make sure that the speaker's battery is fully charged. • Allow the battery to fully charge each time you charge it. The indicator light blinks blue when recharging. The battery is fully charged when the LED changes a blinking blue to a solid blue. • Try charging the speaker using a different power outlet or USB port. • If your speaker still does not work after trying these solutions, contact Rocketfish support at 1-800-620-2790.
<p>The speaker buttons are not controlling my device</p>	<ul style="list-style-type: none"> • Some functions may be restricted depending on the devices paired to the speaker. • If the device is connected to the LINE IN jack, you must use the controls on the device. The buttons on the speaker do not control devices connected to the LINE IN jack.
<p>The microphone does not work</p>	<ul style="list-style-type: none"> • Make sure the device is paired and connected to your speaker. • Make sure device is not muted. • If paired to a computer, set the RF-SPX15 as the default Playback and Recording device (PC) or Output and Input device (MAC).

Frequently asked questions (FAQ)

Question	Answer
How do I switch to another paired device?	See “Switching between paired devices” on page 11.
Can my speaker be paired to more than one device at a time?	Your speaker can be paired with up to eight devices at the same time. However, your speaker can only be connected and playing content from one device at a time. When you turn on your speaker, it automatically connects to the last connected device. To connect to a different paired device, you have to disconnect from the currently connected device and manually connect to the other paired device.
How long does it take to charge my speaker’s battery?	Charging the battery can take about four hours. When the battery is fully charged, it provides up to 10 hours of music playback and up to 720 hours of standby time (depending on the headphone volume level and distance from the paired device).
How do I charge my speaker’s battery?	You can connect your speaker to the AC adapter or a computer’s USB port to charge the battery. See “Charging the battery” on page 8.

Legal notices

FCC and IC information

This equipment has been tested and found to comply with the limits for a Class B digital device, pursuant to Part 15 of the FCC Rules. These limits are designed to provide reasonable protection against harmful interference in a residential installation. This equipment generates, uses and can radiate radio frequency energy and, if not installed and used in accordance with the instructions, may cause harmful interference to radio communications. However, there is no guarantee that interference will not occur in a particular installation. If this equipment does cause harmful interference to radio or television reception, which can be determined by turning the equipment off and on, the user is encouraged to try to correct the interference by one or more of the following measure

- Reorient or relocate the receiving antenna
- Increase the separation between the equipment and receiver.
- Connect the equipment into an outlet on a circuit different from that to which the receiver is connected.
- Consult the dealer or an experienced radio/TV technician for help

Warning: Changes or modifications not expressly approved by the party responsible for compliance could void the user's authority to operate the equipment.

This equipment complies with IC radiation exposure limits set forth for an uncontrolled environment. This equipment should be installed and operated with minimum distance 20cm between the radiator and your body.

This device complies with Part 15 of the FCC Rules and Industry license-exempt RSS standard(s). Operation is subject to the following two conditions: (1) this device may not cause interference, and (2) this device must accept any interference, including interference that may cause undesired operation of the device.

One-year limited warranty

Rocketfish Products ("Rocketfish") warrants to you, the original purchaser of this new **RF-SPX15** ("Product"), that the Product shall be free of defects in the original manufacture of the material or workmanship for one (1) year from the purchase of the Product ("Warranty Period"). This Product must be purchased from an authorized dealer of Rocketfish brand products and packaged with this warranty statement. This warranty does not cover refurbished Product. If you notify Rocketfish during the Warranty Period of a defect covered by this warranty that requires service, terms of this warranty apply.

How long does the coverage last?

The Warranty Period lasts for one year (365 days), beginning on the date you purchased the Product. The purchase date is printed on the receipt you received with the product.

What does this warranty cover?

During the Warranty Period, if the original manufacture of the material or workmanship of the Product is determined to be defective by an authorized Rocketfish repair center or store personnel, Rocketfish will (at its sole option): (1) repair the Product with new or rebuilt parts; or (2) replace the Product at no charge with new or rebuilt comparable products or parts. Products and parts replaced under this warranty become the property of Rocketfish and are not returned to you. If service of Products and parts are required after the Warranty Period expires, you must pay all labor and parts charges. This warranty lasts as long as you own your Rocketfish Product during the Warranty Period. Warranty coverage terminates if you sell or otherwise transfer the Product.

How to obtain warranty service?

If you purchased the Product at a retail store location, take your original receipt and the Product to the store you purchased it from. Make sure that you place the Product in its original packaging or packaging that provides the same amount of protection as the original packaging. If you purchased the Product from an online web site, mail your original receipt and the Product to the address listed on the web site. Make sure that you put the Product in its original packaging or packaging that provides the same amount of protection as the original packaging.

Where is the warranty valid?

This warranty is valid only to the original purchaser of the Product in the United States, Canada, and Mexico.

What does the warranty not cover?

This warranty does not cover:

- Customer instruction
- Installation
- Set up adjustments
- Cosmetic damage

- Damage due to acts of God, such as lightning strikes
- Accident
- Misuse
- Abuse
- Negligence
- Commercial use
- Modification of any part of the Product, including the antenna

This warranty also does not cover:

- Damage due to incorrect operation or maintenance
- Connection to an incorrect voltage supply
- Attempted repair by anyone other than a facility authorized by Rocketfish to service the Product
- Products sold as is or with all faults
- Consumables, such as fuses or batteries
- Products where the factory applied serial number has been altered or removed

REPAIR REPLACEMENT AS PROVIDED UNDER THIS WARRANTY IS YOUR EXCLUSIVE REMEDY. ROCKETFISH SHALL NOT BE LIABLE FOR ANY INCIDENTAL OR CONSEQUENTIAL DAMAGES FOR THE BREACH OF ANY EXPRESS OR IMPLIED WARRANTY ON THIS PRODUCT, INCLUDING, BUT NOT LIMITED TO, LOST DATA, LOSS OF USE OF YOUR PRODUCT, LOST BUSINESS OR LOST PROFITS. ROCKETFISH PRODUCTS MAKES NO OTHER EXPRESS WARRANTIES WITH RESPECT TO THE PRODUCT, ALL EXPRESS AND IMPLIED WARRANTIES FOR THE PRODUCT, INCLUDING, BUT NOT LIMITED TO, ANY IMPLIED WARRANTIES OF AND CONDITIONS OF MERCHANTABILITY AND FITNESS FOR A PARTICULAR PURPOSE, ARE LIMITED IN DURATION TO THE WARRANTY PERIOD SET FORTH ABOVE AND NO WARRANTIES, WHETHER EXPRESS OR IMPLIED, WILL APPLY AFTER THE WARRANTY PERIOD. SOME STATES, PROVINCES AND JURISDICTIONS DO NOT ALLOW LIMITATIONS ON HOW LONG AN IMPLIED WARRANTY LASTS, SO THE ABOVE LIMITATION MAY NOT APPLY TO YOU. THIS WARRANTY GIVES YOU SPECIFIC LEGAL RIGHTS, AND YOU MAY ALSO HAVE OTHER RIGHTS, WHICH VARY FROM STATE TO STATE OR PROVINCE TO PROVINCE.

Contact Rocketfish:

For customer service please call 1-800-620-2790
www.rocketfishproducts.com

Distributed by Best Buy Purchasing, LLC
7601 Penn Avenue South, Richfield, Minnesota, U.S.A. 55423-3645
© 2012 BBY Solutions, Inc.

All rights reserved. ROCKETFISH is a trademark of BBY Solutions, Inc. Registered in some countries. All other products and brand names are trademarks of their respective owners.

This page intentionally left blank



www.rocketfishproducts.com (800) 620-2790

Distributed by Best Buy Purchasing, LLC

7601 Penn Avenue South, Richfield, MN 55423-3645 USA

© 2012 BBY Solutions, Inc.

All rights reserved. ROCKETFISH is a trademark of BBY Solutions, Inc.

All other products and brand names are trademarks of their respective owners.

11-0753
ENGLISH

Free Manuals Download Website

<http://myh66.com>

<http://usermanuals.us>

<http://www.somanuals.com>

<http://www.4manuals.cc>

<http://www.manual-lib.com>

<http://www.404manual.com>

<http://www.luxmanual.com>

<http://aubethermostatmanual.com>

Golf course search by state

<http://golfingnear.com>

Email search by domain

<http://emailbydomain.com>

Auto manuals search

<http://auto.somanuals.com>

TV manuals search

<http://tv.somanuals.com>