



# Rocketboost™ Wireless Amplified Audio Receiver

**RF-RBREC**

**User Guide**



# Rocketfish Rocketboost™ Wireless Amplified Audio Receiver

## Contents

Introduction .....	3
Important safety instructions .....	5
Features .....	8
Setting up your wireless receiver .....	12
Using your wireless receiver .....	16
Expanding your Rocketboost System .....	21
Maintaining your system .....	22
Troubleshooting .....	23
Specifications .....	24
Legal notices .....	25
One-year limited warranty .....	27

## Introduction

Congratulations on your purchase of the Rocketboost™ Wireless Amplified Audio Receiver. This product represents the state of the art in 2.4 GHz wireless audio design. When used with other Rocketboost products you can enjoy your music throughout your house without the limitations of cables.

This Rocketboost wireless receiver comes with a built in audio amplifier. As an amplified wireless receiver you connect it to your speakers and then listen to the audio from any other Rocketboost wireless sender. By using other Rocketboost wireless audio products, you can also configure multiple audio streams and listen to any of those audio streams at any Rocketboost wireless receiver device.

This Rocketboost product can receive signals from Rocketboost wireless senders that are up to 150 feet away. The audio signal is uncompressed digital audio so your audio is the highest quality and is free from interference.

This User Guide explains how to correctly install, operate, and get the best performance from your Rocketboost Wireless Amplified Audio Receiver. Read this guide carefully before installing your system, and then keep it handy for quick reference.

## Package contents

The box should contain the following:



Wireless receiver



Speaker cable (2)

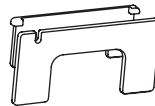

Cable spool



Remote control



AC power cord







User Guide



Quick Setup Guide

## Important safety instructions

	<b>CAUTION</b> RISK OF ELECTRIC SHOCK DO NOT OPEN	
	<p>The lightning flash with arrowhead symbol, within an equilateral triangle is intended to alert the user to the presence of uninsulated "dangerous voltage" within the product's enclosure that may be of sufficient magnitude to constitute a risk of electric shock to persons.</p>	
	<p>The exclamation point within an equilateral triangle is intended to alert the user to the presence of important operating and maintenance (servicing) instructions in the literature accompanying the appliance.</p>	
<p><b>CAUTION:</b> TO REDUCE THE RISK OF ELECTRIC SHOCK: DO NOT REMOVE SCREWS, COVERS OR THE CABINET. NO USER SERVICING PARTS INSIDE. REFER SERVICING TO QUALIFIED SERVICE PERSONNEL.</p>		

- 1 Read these instructions.
- 2 Keep these instructions.
- 3 Heed all warnings.
- 4 Follow all instructions.
- 5 Do not use this apparatus near water.
- 6 Clean only with a dry cloth.
- 7 Do not block any ventilation openings. Install in accordance with the manufacturer's instructions.
- 8 Do not install near any heat sources such as radiators, heat registers, stoves, or other apparatus (including amplifiers) that produce heat.
- 9 Do not defeat the safety purpose of the polarized or grounding-type plug. A polarized plug has two blades with one wider than the other. A grounding type plug has two blades and a third grounding prong. The wide blade or the third prong are provided for your safety. If the provided plug does not fit into your outlet, consult an electrician for replacement of the obsolete outlet.

- 10 Protect the power cord from being walked on or pinched particularly at plugs, convenience receptacles, and the point where they exit from the apparatus.
- 11 Only use attachments/accessories specified by the manufacturer.
- 12 Unplug this apparatus during lightning storms or when unused for long periods of time.
- 13 Refer all servicing to qualified service personnel. Servicing is required when the apparatus has been damaged in any way, such as power-supply cord or plug is damaged, liquid has been spilled or objects have fallen into the apparatus, the apparatus has been exposed to rain or moisture, does not operate normally, or has been dropped.
- 14 To reduce the risk of fire or electric shock, do not expose this device to rain, moisture, dripping, or splashing, and no objects filled with liquids, such as vases, shall be placed on it.
- 15 The wall plug is the disconnecting device. The plug must remain readily operable.
- 16 Batteries should not be exposed to excessive heat such as sunshine, fire, or the like.

**Caution:** *Danger of explosion if battery is incorrectly replaced. Replace only with the same or equivalent type.*

**Warning:** *Read the Rating Label on the bottom of the unit for power input and other safety information.*

**Caution - Proper Installation**

*Install the system in a place which is level, dry and neither too hot nor too cold. The appropriate temperature is between 5° C and 35° C.*

*Install the system in a location with adequate ventilation to prevent internal heat from building up inside the unit.*

## **Proper ventilation**

To avoid risk of electric shock and fire, and to prevent damage, locate the apparatus as follows:

**Front:** No obstructions and open spacing.

**Sides/Top/Back:** No obstructions should be placed in the areas shown by the dimensions below.

**Bottom:** Place on the level surface. Maintain an adequate air path for ventilation by placing on a stand with a height of 3-15/16" (10 cm) or more.

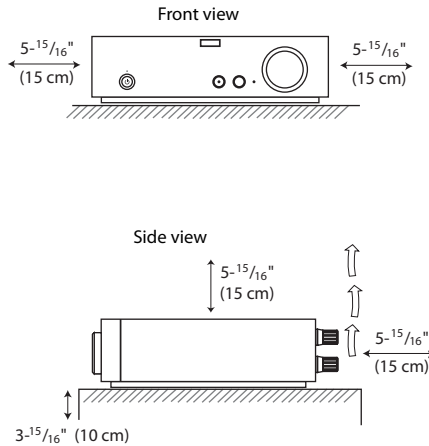

## What is Rocketboost™?

Rocketboost™ is expandable wireless digital audio.

- Products with Rocketboost™ technology let you easily expand your listening experience throughout your home.
- Rocketboost™ does not interfere with other wireless products in your home.
- Rocketboost™ is uncompressed digital audio compatible with all audio formats such as Dolby® TrueHD, and DTS-HD Master Audio used with Blu-ray.



When you see the Rocketboost™ logo on any product, it has been designed to work with other Rocketboost™ products, no matter who manufactures them.

## How does Rocketboost™ work?

Rocketboost technology can connect all audio devices throughout your home to form a home audio network.

Rocketboost products include “Wireless Senders,” which send or transmit audio streams, and “Wireless Receivers,” which receive the audio. This lets you listen to music from your wireless sender in other rooms using your wireless receiver.

Rocketboost is expandable. Each Rocketboost wireless receiver can select the audio from any wireless sender in your Rocketboost audio network. The following shows an example Rocketboost network. You can set up your network to meet your specific needs.

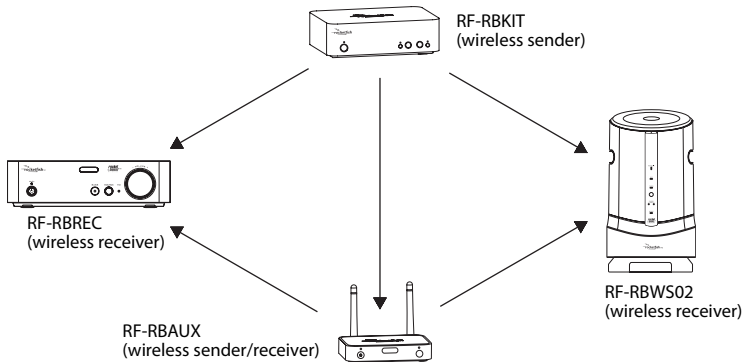

We hope you enjoy your new Rocketboost system. Remember that it's designed to grow with your home entertainment needs, and that it's easy to add a new device to the network as you expand your system.

## Features

- High-Performance Audio - Uncompressed digital CD-quality sound, adjustable volume control
- Strong Wireless Signal - 150 ft. wireless range (maximum, line of sight), great sound, no static, won't interfere with your other wireless products



- Compatible with all Rocketboost products
- Easy to use - Easy to set up
- Two stereo channels with 42 W per channel, capable of driving any non-powered speaker.

## Front panel

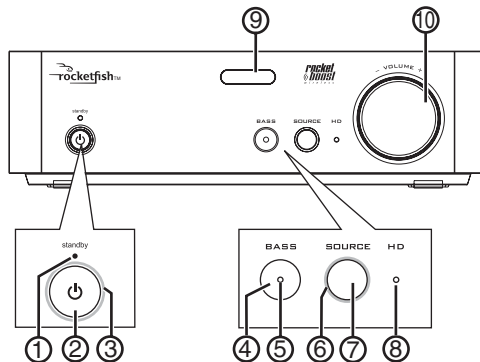

#	Feature	Description
1	Standby indicator	Turns red when the wireless receiver is in standby mode.
2	Power/Pair button	Press to turn the wireless receiver on. Press and hold to initiate pairing. Press again to go to standby mode.
3	Power/Pair indicator	The indicator will turn solid when it is paired in a network, if the device is not in a network, the indicator blinks slowly. When the device is put in pairing mode, the indicator blinks rapidly.
4	BASS button	Toggles bass enhancement on or off. Bass enhancement increases the bass frequency output of the system.
5	Bass indicator	Lights when the bass enhancement is activated.
6	SOURCE indicator	Lights when the wireless receiver is connected to an audio stream.
7	SOURCE button	Press to select different audio streams on your Rocketboost network. Each press moves to the next source.
8	HD indicator	Lights when the wireless receiver is receiving HD audio signals.
9	IR sensor window	Receives the signal from the remote control.
10	VOLUME knob	Controls the volume level.

## Back panel

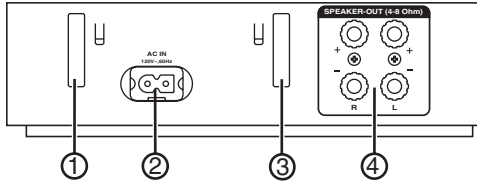

#	Feature	Description
1 & 3	Slots for removable cable spool	Use to mount the cable spool on the wireless receiver.
2	AC IN connector	Plug the AC power cord into this connector.
4	SPEAKER OUT jacks	Connect your unamplified speakers to these jacks.

## Remote control

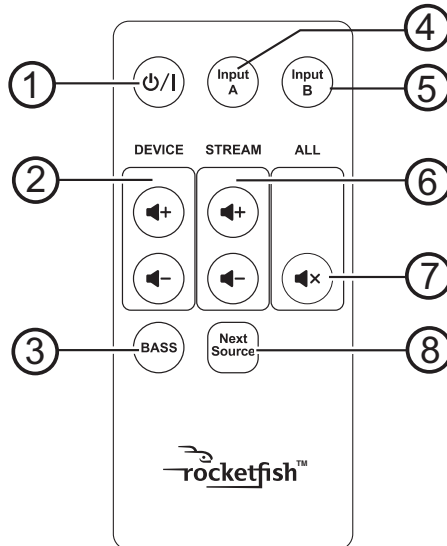

#	Feature	Description
1	⏻/  Standby/On button	Press to turn the wireless receiver on. Press again to enter standby mode.
2	Volume ⏪/+/- buttons (device)	Press to adjust the volume of the wireless receiver.
3	<b>BASS</b> button	Press to enable/disable the BASS enhancement.
4	<b>Input A</b>	Press to toggle between <b>SPEAKER-In A</b> or <b>Pre-In A</b> of the wireless sender (only applies to Rocketboost model RF-RBKIT, purchased separately).
5	<b>Input B</b>	Press to toggle between <b>SPEAKER-In B</b> or <b>Pre-In B</b> of the wireless sender (only applies to Rocketboost model RF-RBKIT, purchased separately).
6	Volume ⏪/+/- buttons (stream)	Press to adjust the volume of all devices receiving the same audio stream.
7	⏻× (mute - all)	Press to mute all audio streams in your Rocketboost network. Pressing mute again at any Rocketboost wireless receiver will “unmute” the stream that was last heard at that wireless receiver. This stream can now be heard from any other wireless receiver that was receiving that stream. Other streams are unmuted in the same way: pressing mute again at each wireless receiver will unmute the stream that was last heard at that wireless receiver.
8	<b>Next Source</b> button	Press to select different audio streams on your Rocketboost network. Each press moves to the next source.

# Setting up your wireless receiver

## Listening to music throughout your home

Rocketboost technology can connect all of the audio devices throughout your home to form a wireless home audio network. Rocketboost products include “senders,” which send audio streams, and “receivers,” which receive the audio. This lets you listen to music from your sender in other rooms, using your receiver.

The RF-RBREC is a Rocketboost receiver with a built-in amplifier. You can connect speakers to the RF-RBREC and then listen to audio from any of your Rocketboost sender devices.

The illustration shows an example Rocketboost network.

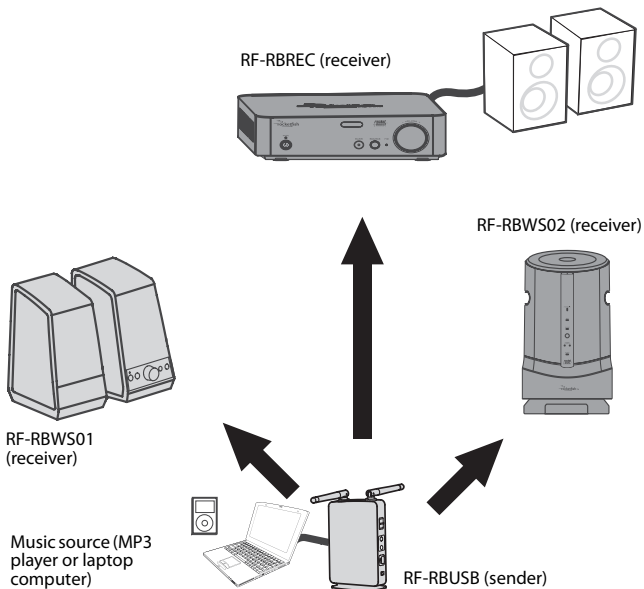

Rocketboost is expandable. Each Rocketboost wireless receiver can select the audio from any wireless sender in your Rocketboost audio network. So you can use additional wireless receivers, like the Wireless Amplified Audio Receiver (RF-RBREC), Wireless Bookshelf Speakers (RF-RBWS01), or the Wireless Indoor/Outdoor Speaker (RF-RBWS02) to listen to music throughout your home.

**To make the connections:**

- 1 Connect the right speaker to the right speaker-out terminals on the wireless receiver. Use a red speaker wire to connect the red (+) speaker-out terminal and a black speaker wire to connect the black (-) speaker-out terminal. Repeat this step to connect the left speaker.

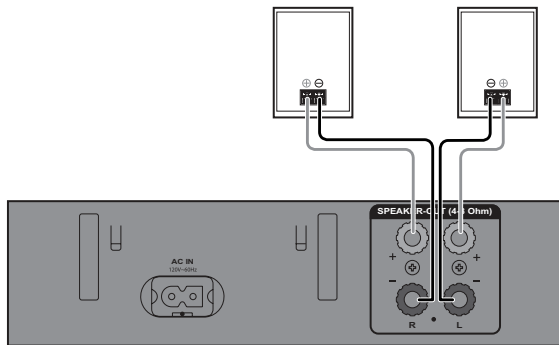

- 2 Connect one end of the AC power cord to the AC IN jack on the back of the wireless receiver, then plug the other end of the AC power cable into an AC power outlet. The Standby indicator turns on.

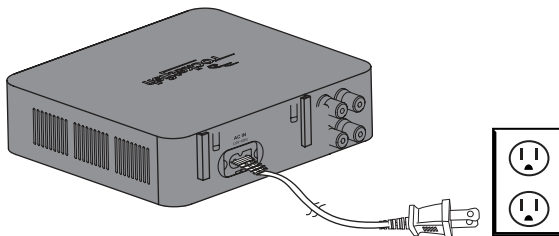

**Cautions:** To avoid risk of fire and to prevent damage:

- Do not use AC adapters other than the supplied AC adapter.

- Do not use the supplied AC adapter for other equipment.

**Tips:**

- Slide the cable spool (provided) into the slots on the back of the receiver from the top down.

- Before connecting to the AC power outlet, wrap the excessive cable around the spool.

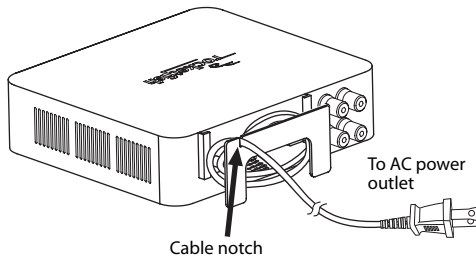

For information on connecting a wireless sender, refer to the manual for that device.

## Setting up and using your remote control

**To set up and use your remote control:**

- 1 Remove the insulation sheet in the battery tray before using the remote control for the first time.

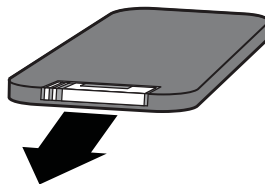

- 2 Aim the remote control at the IR sensor on the front of the wireless receiver from a maximum distance of 23 ft. (7 m) away and a maximum angle of +/- 30 degrees from the center line.

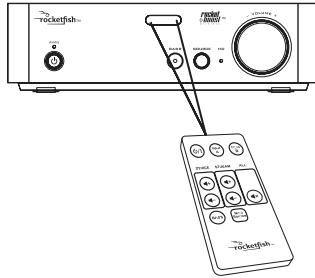

**To replace the battery:**

- 1 Press the battery tray lock to the right, then slide out the battery tray. You can remove the battery door with your fingernails by using the spaces set back in the remote control.

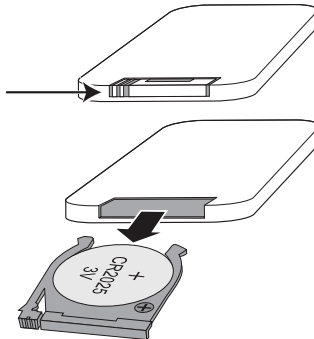

- 2 Match the polarity on the lithium cell with a plus sign (+) on the battery tray.

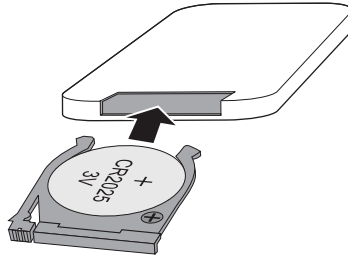

Replace the battery with a CR2025 or equivalent.

- 3 Slide the tray with the new battery into the battery compartment until it clicks into place.

**Warnings:**

*Danger of explosion if battery is incorrectly replaced.*

*Replace only with the same or equivalent type of battery.*

**Notes:**

*Remove the battery from the remote control when it is not to be used for a long period. Otherwise it might be damaged due to battery leakage.*

*Do not drop or jar the remote control.*

*Do not spill water or any liquid on the remote control.*

*Do not place the remote control on a wet object.*

*Do not place the remote control under direct sunlight or near sources of excessive heat.*

## Using your wireless receiver

### Turning the wireless receiver on and off

**To turn the wireless receiver on and off:**

- 1 To turn off the device, press  $\odot$ . The power indicator turns off and the standby indicator turns red.
- 2 If the wireless receiver is off, press  $\odot$  to turn it on. The power indicator lights.



## Establishing communication

Rocketboost products form an audio network and each Rocketboost wireless receiver can select the audio from any Rocketboost wireless sender in the network.



### Important

Every Rocketboost network must contain one hub device, which helps devices join the network. The network can have only one hub, which you can enable using the hub switch on the back of all Rocketboost wireless senders and wireless sender/receivers.

The RF-RBREC is a wireless receiver and is not a hub device. To add this wireless receiver to your Rocketboost network, you need to pair it to your hub device.

*Important: Hub devices must always have power for your network to operate. The hub device can be in standby (power saving) mode, but must stay plugged in.*

### To establish communications:

- 1 If possible, bring your Rocketboost hub device and the new Rocketboost wireless receiver into the same room.
- 2 Press the Power button on the Rocketboost hub device to turn it on.
- 3 Press the Power button on your Rocketboost wireless receiver to turn it on.
- 4 Press and hold the  on the Rocketboost hub device for more than three seconds to put it into pairing mode. The power indicator starts blinking rapidly and the unit will stay in pairing mode for 30 seconds.
- 5 Press and hold the  on your Rocketboost wireless receiver for more than three seconds to put it into pairing mode.
  - When successfully paired, the power indicator LEDs on both products will stop blinking and stay on.
  - If pairing fails after 30 seconds, the power indicator LEDs will begin flashing at a slower rate. If this occurs, repeat the above steps.

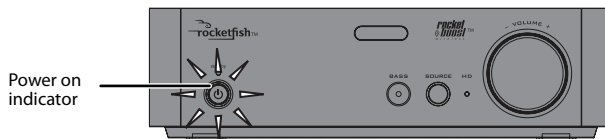

*Note: Rocketboost devices have their own memory. After the devices are paired once, they will remember each other and pair automatically when they are powered on again. Because of this, you can pair all of your network components in the same room before installing them in their permanent locations throughout the house.*

## Listening to music

### *To listen to music:*

- 1 Turn on the audio source connected to the Rocketboost wireless sender. Make sure the volume of the audio source is turned up and not muted, otherwise no audio will be sent over the Rocketboost network.
- 2 Turn on the wireless sender and wireless receiver. The power indicator LEDs should light steadily. If they are blinking you need to re-pair the wireless sender and wireless receiver. See “Establishing communication” on page 17.
- 3 Play music from the audio device connected to your wireless sender and listen to it from speakers attached to the wireless receiver.
- 4 Adjust the volume level on your wireless receiver. If you have multiple audio sources in your Rocketboost network, press the **SOURCE** button on the wireless receiver to hear the next audio source. Press the **SOURCE** button again to cycle through all available audio sources.

## Controlling the device volume

The volume of the wireless receiver can be changed.

### *To change the volume of the wireless receiver:*

- Aim the remote control at the wireless receiver and press the DEVICE volume buttons on the remote control, or turn the volume knob on the wireless receiver to adjust the volume.

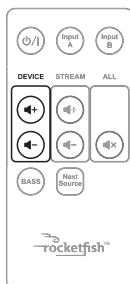

## Controlling the stream volume

Rocketboost systems have a special mode where you can change the volume of the audio stream sent by a wireless sender. Then the volume level at each wireless receiver that is receiving that audio stream will change automatically. This is useful if you want to easily change the volume level at all the wireless receivers that are receiving the same audio stream.

### *To change the stream volume:*

- Aim the remote control at the wireless sender and press the STREAM volume button on the remote control.

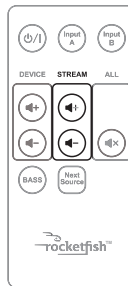

## Muting all devices

Rocketboost also features a global mute feature that instantly silences all audio streams in the network.

### **To mute all devices in the network:**

- 1 Press **ALL** (mute) on the remote control. All audio streams in your network are muted.

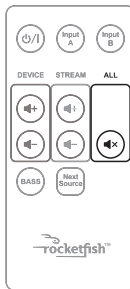

- 2 Pressing **ALL** (mute), while aiming at a specific Rocketboost wireless receiver, will “unmute” the stream that was last heard at that wireless receiver. This stream can now be heard from any other wireless receiver that was receiving that stream. Other streams are unmuted in the same way: pressing mute again at each wireless receiver will unmute the stream that was last heard at that wireless receiver.

## Turning off the system

### **To turn off the system:**

- Press **Power** on the wireless receiver to turn off the unit.
  - The power indicator turns off and the standby indicator lights red.
  - Remove the AC power cord from the AC power outlet to power off the device completely.

### **Notes:**

- If there are other wireless senders and wireless receivers in the network, you must keep your Hub powered on. The hub can be in standby, but it needs to be connected to the AC adapter.

- The device has its own memory. After the wireless sender and wireless receiver are paired once, they will remember each other and pair automatically when the wireless sender and wireless receiver are powered on again.

## Expanding your Rocketboost System

Rocketboost technology is expandable. Each Rocketboost wireless receiver can select the audio from any wireless sender in your Rocketboost audio network. The following shows an example Rocketboost network. You can set up your network to meet your specific needs.

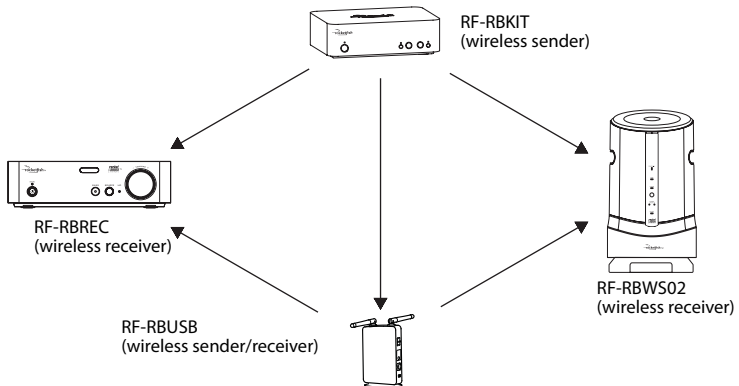

- The Rocketboost Wireless Outdoor Speaker (RF-RBWS02) includes a wireless speaker and the RF-RBAUX wireless sender/receiver. Audio sources connected to the wireless sender/receiver can be listened to using the wireless speaker.
- The Rocketboost Wireless Sender/Receiver (RF-RBUSB) can be used as both a wireless sender and a wireless receiver. As a wireless sender you can connect it to your other audio source devices (like home theater or mp3 player) and then receive that audio using your outdoor wireless speaker or any other Rocketboost wireless receiver. As a wireless receiver you can connect it your stereo system or amplified speakers and then listen to the audio from any other Rocketboost wireless sender.
- The Rocketboost Amplified Audio Receiver (RF-RBREC) is an amplified wireless receiver. You connect speakers to this and then listen to audio from any of your Rocketboost wireless sender devices. This is a great way to expand your Rocketboost system to listen to your music anywhere in the house.

- The Rocketboost Wireless HD Starter Kit (RF-RBKIT) includes a wireless sender device and the RF-RBREC, amplified wireless receiver. This product can be used for home theater wireless surround sound of for multi-room audio.
- The Rocketboost Wireless Headphones (RF-RBWHP01) include a wireless sender device and wireless headphones. Audio sources connected to the wireless sender can be listened to using the wireless speakers.

For more information, and to see what other Rocketboost products are available, visit [www.rocketboost.com](http://www.rocketboost.com).

## Rocketboost Network Capabilities

The maximum number of Rocketboost devices in a Rocketboost Network is 9. If you already have 9 devices and attempt to pair another one, then pairing will fail for the new device.

*Note: If you want to remove a device from your Rocketboost network you need to re-pair it to a different hub device (this basically creates a 2nd Rocketboost network).*

The maximum number of audio streams that can be sent simultaneously on the Rocketboost network is:

- 5 stereo CD quality -or-
- 1 stereo HD quality + 3 CD quality -or-
- 2 stereo HD quality + 2 stereo CD quality -or-
- 3 stereo HD quality

*Note: HD streams are available if using the wireless sender. If your system is in a maximum audio stream state, then the TX indicator will not light on the wireless sender devices that have exceeded the maximum. To use those device's audio streams, you need to turn off one of your other wireless senders.*

## Maintaining your system

Use a soft cloth dampened with a weak solution of mild detergent and water. Dry the device immediately afterwards with a clean cloth. Do not use abrasive cloth, thinners, alcohol, or other chemical solvents, because they may damage the finish or remove the panel lettering.

**Cautions:**

*Do not block the ventilation openings.*

*If the power cord is damaged, it must be repaired by a qualified technician.*

# Troubleshooting

Check this information for a possible solution before calling for assistance.

## General troubleshooting

- Every Rocketboost network must contain only one hub device, which helps other Rocketboost devices join the network.
  - You can turn any Rocketboost wireless sender or wireless sender/receiver into a hub by using the HUB STATUS or HUB ENABLE switch on the back of the device. The network can only have one hub.
  - The hub device must have power for the audio network to operate. The hub can be in standby (power-saving mode), but must remain plugged in.
  - The existing hub device will be the device with the green power indicator.
- The unobstructed operating range of a Rocketboost network is 150 feet (45 meters).
- Each network must contain both a wireless sender device and a wireless receiver device. Do you have both a wireless sender and a wireless receiver device?

Problem	Solution
No communication between the Rocketboost wireless sender and wireless receiver devices.	<ul style="list-style-type: none"> <li>• Make sure that the power indicators of the Rocketboost wireless sender and wireless receiver devices are lit solidly. If the indicators are blinking, see "Establishing communication" on page 17.</li> <li>• If the pairing process is failing, make sure that only one of your Rocketboost devices has the Hub switch enabled. Note that the hub device will be the only device with the green power indicator. Non-hub devices have a blue power indicator.</li> </ul>
No sound	<ul style="list-style-type: none"> <li>• Check the volume level of the wireless speaker or audio sources connected to the wireless sender.</li> <li>• Make sure that all of the audio cables are connected correctly.</li> <li>• Make sure that the power indicators of the Rocketboost wireless sender and wireless receiver devices are lit solidly. If the indicators are blinking, see "Establishing communication" on page 17.</li> <li>• Make sure the audio source connected to your wireless sender is On.</li> <li>• Make sure the wireless sender or wireless receiver devices are not Muted. The Source indicator light on the wireless receiver blinks when the device is muted.</li> </ul>

Problem	Solution
My Rocketboost remote will not control the volume. I can't turn the volume up or down.	<ul style="list-style-type: none"> <li>• Make sure you have removed the insulation sheet in the battery tray of the Rocketboost remote.</li> <li>• To maximize your volume level through the system, make sure your source devices (i.e., A/V receiver, iPod, etc.) have their volume turned up to at least 50% of their volume level.</li> <li>• The battery in your remote may be dead. Try replacing it with a new battery.</li> </ul>
The sound/audio is really quiet coming out of my wireless speakers.	<ul style="list-style-type: none"> <li>• To maximize your volume level through the system, make sure your source devices (i.e., A/V receiver, iPod, etc.) have their volume turned up to at least 50% of their volume level.</li> </ul>
Sound interference	<ul style="list-style-type: none"> <li>• Experiment with different orientations or locations of your wireless sender device.</li> <li>• Make sure your wireless sender device is more than 18 inches from any WiFi routers you may have.</li> <li>• Shorten the distance between the Rocketboost devices. The maximum distance is 150 feet (45 m), but this distance will be reduced as the wireless signal passes through walls or other obstructions.</li> <li>• It is possible other devices like cordless phones, microwaves, wireless routers, etc. may be causing interference. Try turning one device off at a time to determine which device is causing interference.</li> <li>• If your cordless phone or wireless router is causing interference try changing the channel it is using. Please refer to your device's owner manual.</li> </ul>

## Specifications

<b>Audio input - wireless</b>	Stereo, 16-bit, 48KHz, uncompressed Wireless audio system performance Signal-to-Noise Ratio: 94dB (96dB in HD mode) Total harmonic distortion: 1%
<b>Audio output</b>	High efficiency. Class D, speaker level Supports 4 to 8 ohm speakers Audio output power: 2 × 42 W (RMS) into 4 ohms
<b>Transmission delay</b>	15 to 20 ms
<b>Power supply</b>	AC 120V~60 Hz (RF-RBREC) AC 220-240V~50 Hz (RF-RBREC-05A)
<b>Power consumption</b>	30 W



## Legal notices

### FCC and IC Information:

This device complies with Part 15 of the FCC Rules and RSS-210 of the IC Rules. Operation is subject to the following two conditions: (1) This device may not cause harmful interference, and (2) this device must accept any interference received, including interference that may cause undesired operation.

**Warning:** Changes or modifications to this unit not expressly approved by the party responsible for compliance could void the user's authority to operate the equipment.

**Note:** This equipment has been tested and found to comply with the limits for a Class B digital device, pursuant to Part 15 of the FCC Rules. These limits are designed to provide reasonable protection against harmful interference in a residential installation. This equipment generates, uses and can radiate radio frequency energy and, if not installed and used in accordance with the instructions, may cause harmful interference to radio communications. However, there is no guarantee that interference will not occur in a particular installation. If this equipment does cause harmful interference to radio or television reception, which can be determined by turning the equipment off and on, the user is encouraged to try to correct the interference by one or more of the following measures:

- Reorient or relocate the receiving antenna.
- Increase the separation between the equipment and receiver.
- Connect the equipment into an outlet on a circuit different from that to which the receiver is connected.
- Consult the dealer or an experienced radio/TV technician for help.

### FCC & IC Radiation Exposure Statement

This equipment complies with FCC radiation exposure limits set forth for an uncontrolled environment and meets the exemption from the routine evaluation limits in section 2.5 of RSS 102.

1. This Transmitter must not be co-located or operating in conjunction with any other antenna or transmitter.

2. This equipment complies with FCC RF radiation exposure limits set forth for an uncontrolled environment. This equipment should be installed and operated with a minimum distance of 20 centimeters from user and bystanders.

The device meets the exemption from the routine evaluation limits in section 2.5 of RSS 102 and users can obtain Canadian information on RF exposure and compliance from the Canadian Representative Richardson Technical Services Inc., Suite 304, 131 Wurtemberg St., Ottawa, Ontario, Canada. Tel: 613 562 3827

Rocketboost is a trademark of BBY Solutions, Inc.

## Information for Users on Disposal of Old Equipment

### European Union

*Note: This symbol is only valid in the European Union.*



This symbol indicates that the electrical and electronic equipment should not be disposed of as general household waste at its end-of-life. Instead, the product should be handed over to the applicable collection point for the recycling in accordance with your national legislation.

By disposing of this product correctly, you will help to conserve natural resources and will help prevent potential negative effects on the environment and human health that could otherwise be caused by inappropriate waste handling of this product. For more information about collection point and recycling of this product, please contact your local municipal office, your household waste disposal service or the shop where you purchased the product.

Penalties may be applicable for incorrect disposal of this waste, in accordance with national legislation.

### Other Countries Outside the European Union

If you wish to dispose of this product, please do so in accordance with applicable national legislation or other rules in your country for the treatment of old electrical and electronic equipment.

## One-year limited warranty

Rocketfish Products ("Rocketfish") warrants to you, the original purchaser of this new **RF-RBREC** ("Product"), that the Product shall be free of defects in the original manufacture of the material or workmanship for one (1) year from the purchase of the Product ("Warranty Period"). This Product must be purchased from an authorized dealer of Rocketfish brand products and packaged with this warranty statement. This warranty does not cover refurbished Product. If you notify Rocketfish during the Warranty Period of a defect covered by this warranty that requires service, terms of this warranty apply.

### How long does the coverage last?

The Warranty Period lasts for one year (365 days), beginning on the date you purchased the Product. The purchase date is printed on the receipt you received with the product.

### What does this warranty cover?

During the Warranty Period, if the original manufacture of the material or workmanship of the Product is determined to be defective by an authorized Rocketfish repair center or store personnel, Rocketfish will (at its sole option): (1) repair the Product with new or rebuilt parts; or (2) replace the Product at no charge with new or rebuilt comparable products or parts. Products and parts replaced under this warranty become the property of Rocketfish and are not returned to you. If service of Products and parts are required after the Warranty Period expires, you must pay all labor and parts charges. This warranty lasts as long as you own your Rocketfish Product during the Warranty Period. Warranty coverage terminates if you sell or otherwise transfer the Product.

### How to obtain warranty service?

If you purchased the Product at a retail store location, take your original receipt and the Product to the store you purchased it from. Make sure that you place the Product in its original packaging or packaging that provides the same amount of protection as the original packaging. If you purchased the Product from an online web site, mail your original receipt and the Product to the address listed on the web site. Make sure that you put the Product in its original packaging or packaging that provides the same amount of protection as the original packaging.

### Where is the warranty valid?

This warranty is valid only to the original purchaser of the Product in the United States, Canada, and Mexico.

### What does the warranty not cover?

This warranty does not cover:

- Customer instruction
- Installation
- Set up adjustments
- Cosmetic damage

- Damage due to acts of God, such as lightning strikes
- Accident
- Misuse
- Abuse
- Negligence
- Commercial use
- Modification of any part of the Product, including the antenna

This warranty also does not cover:

- Damage due to incorrect operation or maintenance
- Connection to an incorrect voltage supply
- Attempted repair by anyone other than a facility authorized by Rocketfish to service the Product
- Products sold as is or with all faults
- Consumables, such as fuses or batteries
- Products where the factory applied serial number has been altered or removed

REPAIR REPLACEMENT AS PROVIDED UNDER THIS WARRANTY IS YOUR EXCLUSIVE REMEDY. ROCKETFISH SHALL NOT BE LIABLE FOR ANY INCIDENTAL OR CONSEQUENTIAL DAMAGES FOR THE BREACH OF ANY EXPRESS OR IMPLIED WARRANTY ON THIS PRODUCT, INCLUDING, BUT NOT LIMITED TO, LOST DATA, LOSS OF USE OF YOUR PRODUCT, LOST BUSINESS OR LOST PROFITS. ROCKETFISH PRODUCTS MAKES NO OTHER EXPRESS WARRANTIES WITH RESPECT TO THE PRODUCT, ALL EXPRESS AND IMPLIED WARRANTIES FOR THE PRODUCT, INCLUDING, BUT NOT LIMITED TO, ANY IMPLIED WARRANTIES OF AND CONDITIONS OF MERCHANTABILITY AND FITNESS FOR A PARTICULAR PURPOSE, ARE LIMITED IN DURATION TO THE WARRANTY PERIOD SET FORTH ABOVE AND NO WARRANTIES, WHETHER EXPRESS OR IMPLIED, WILL APPLY AFTER THE WARRANTY PERIOD. SOME STATES, PROVINCES AND JURISDICTIONS DO NOT ALLOW LIMITATIONS ON HOW LONG AN IMPLIED WARRANTY LASTS, SO THE ABOVE LIMITATION MAY NOT APPLY TO YOU. THIS WARRANTY GIVES YOU SPECIFIC LEGAL RIGHTS, AND YOU MAY ALSO HAVE OTHER RIGHTS, WHICH VARY FROM STATE TO STATE OR PROVINCE TO PROVINCE.

Contact Rocketfish:

For customer service please call 1-800-620-2790  
[www.rocketfishproducts.com](http://www.rocketfishproducts.com)

Distributed by Best Buy Purchasing, LLC  
 7601 Penn Avenue South, Richfield, Minnesota, U.S.A. 55423-3645  
 © 2011 BBY Solutions, Inc.

All rights reserved. ROCKETFISH is a trademark of BBY Solutions, Inc. Registered in some countries. All other products and brand names are trademarks of their respective owners.

For model number RF-RBREC-05A:

Distributed by: Best Buy Europe Distributions Limited. 1 Portal Way, London W3 6RS  
 Freephone number for Rocketfish products: 0800 389 1120



[www.rocketfishproducts.com](http://www.rocketfishproducts.com) (800) 620-2790

Distributed by Best Buy Purchasing, LLC  
7601 Penn Avenue South, Richfield, MN 55423-3645 USA

© 2011 BBY Solutions, Inc.

All rights reserved. ROCKETFISH is a trademark of BBY Solutions, Inc.  
All other products and brand names are trademarks of their respective owners.

For model number RF-RBREC-05A:

Distributed by: Best Buy Europe Distributions Limited. 1 Portal Way, London W3 6RS  
Freephone number for Rocketfish products: 0800 389 1120

10-1328  
ENGLISH

## Free Manuals Download Website

<http://myh66.com>

<http://usermanuals.us>

<http://www.somanuals.com>

<http://www.4manuals.cc>

<http://www.manual-lib.com>

<http://www.404manual.com>

<http://www.luxmanual.com>

<http://aubethermostatmanual.com>

Golf course search by state

<http://golfingnear.com>

Email search by domain

<http://emailbydomain.com>

Auto manuals search

<http://auto.somanuals.com>

TV manuals search

<http://tv.somanuals.com>