

punch 500.2
power

new
chrome
heatsink

 **Rockford Fosgate**[®]
c a r a u d i o for 

competition power amplifier
operation & installation

punch

 **The
punch**[®]

Dear Customer,

Congratulations on your purchase of the world's finest brand of car audio amplifiers. At Rockford Fosgate we are fanatics about musical reproduction at its best, and we are pleased you chose our product. Through years of engineering expertise, hand craftsmanship and critical testing procedures, we have created a wide range of products that reproduce music with all the clarity and richness you deserve.

For maximum performance we recommend you have your new Rockford Fosgate product installed by an Authorized Rockford Fosgate Dealer, as we provide specialized training through Rockford Technical Training Institute (RTTI). Please read your warranty and retain your receipt and original carton for possible future use.

Great product and competent installations are only a piece of the puzzle when it comes to your system. Make sure that your installer is using 100% authentic installation accessories from Connecting Punch in your installation. Connecting Punch has everything from RCA cables and speaker wire to Power line and battery connectors. Insist on it! After all, your new system deserves nothing but the best.

To add the finishing touch to your new fanatic image order your Rockford Fosgate wearables, which include everything from T-shirts and jackets to hats and sunglasses.

To get a free brochure on Rockford Fosgate products and Rockford wearables, please call 602-967-3565 or FAX 602-967-8132. For International orders, FAX +001-1-602-967-8132 or call +001-1-602-967-3565.

PRACTICE SAFE SOUND™

CONTINUOUS EXPOSURE TO SOUND PRESSURE LEVELS OVER 100dB MAY CAUSE PERMANENT HEARING LOSS. HIGH POWERED AUTOSOUND SYSTEMS MAY PRODUCE SOUND PRESSURE LEVELS WELL OVER 130dB. USE COMMON SENSE AND PRACTICE SAFE SOUND.

If, after reading your manual, you still have questions regarding this product, we recommend that you see your Rockford Fosgate dealer. If you need further assistance, you can call us direct at 1-800-669-9899. Be sure to have your serial number, model number and date of purchase available when you call.

The serial number can be found on the outside of the box. Please record it in the space provided below as your permanent record. This will serve as verification of your factory warranty and may become useful in recovering your amplifier if it is ever stolen.

Serial Number: _____

Model Number: _____

TABLE OF CONTENTS

Introduction	1
Accessory Pack	1
Technical Design Features	2
Design Features	5
Installation Considerations	7
Mounting Locations	8
Battery and Charging	8
Wiring the System	9
Using Passive Crossovers	10
Table of Crossover Components	11
Using the XCard	12
Customizing the XCard	12
XCard Resistor Chart	13
XCard Configurations	14
Installation	16
Using the Balanced Line Inputs	19
Rockford Fosgate Accessories	21
Troubleshooting	23
Autosound 2000's Quick Check for Troubleshooting	25
Dynamic Power Measurements	27
500.2 Specifications	28
Warranty Information	29
International Information	30

GETTING STARTED

Welcome to Rockford Fosgate! This manual is designed to provide information for the owner, salesperson and installer. For those of you who want quick information on how to install this product please turn to the **Installation** section of this manual or refer to the icons listed below. Other information can be located by using the Table of Contents. We, at Rockford Fosgate, have worked very hard to make sure all the information in this manual is current. But, as we are constantly finding new ways to improve our product, this information is subject to change without notice.



Sections marked
**ADVANCED
OPERATION**
include in-depth
technical information

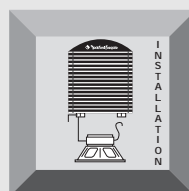

Sections marked
INSTALLATION
include "slam dunk"
wiring connections

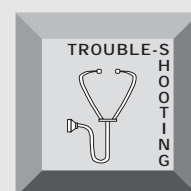

Sections marked
TROUBLE-SHOOTING
include recommendations
for curing installation
problems

INTRODUCTION

The Punch Power series of amplifiers represent the best Rockford Fosgate has to offer! Our engineers devised technical features which would be considered overkill by other audio manufacturers, but not at Rockford Fosgate! Trans•nova, DIAMOND, and TOPAZ, exclusively designed by Rockford, are just a few of these features which are described in the Technical Design Features section of this manual.

ACCESSORY PACK

The accessory pack includes the mounting hardware necessary to secure the amplifier to the vehicle and to attach the end caps to the amplifier.

Punch Power 500.2

Installation & Operation Manual

Punch Verification Certificate

- (4) Amplifier mounting screws (#8 x 3/4" phillips)
- (4) Speaker connector screws (3/32" allen)
- (2) Power connector screws (1/8" allen)
- (4) End cap mounting screws (9/64" allen)
- (1) Allen wrench 3/32" (speaker)
- (1) Allen wrench 9/64" (end cap)
- (1) Allen wrench 1/8" (power)

TECHNICAL DESIGN FEATURES

◆ trans•nova (TRANSconductance NOdal Voltage Amplifier)

The **trans•nova** (TRANS conductance NOdal Voltage Amplifier) is a patented circuit (U.S. Patent 4,467,288) that allows the audio signal to pass through the amplifier at *low voltage*. Each amplifier channel utilizes its own “fully floating” power supply and is configured to increase power gain. The increase in power gain allows the drive stage to operate at a lower voltage. A low voltage drive stage is the same principle used in high quality preamplifiers to produce high linearity and wide bandwidth.

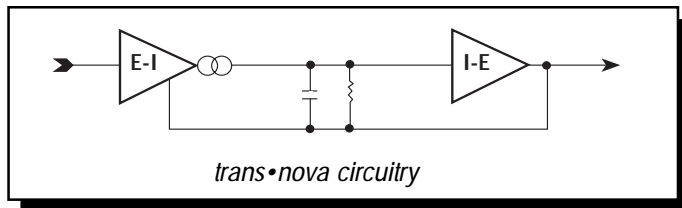

The resulting design utilizes an output stage with a simpler gain structure and a shorter total signal path than conventional high voltage (bi-polar) designs. The number of stages is reduced from five or more to three. The output stage is further refined into a trans-impedance stage (current to voltage converter) to achieve a short loop (fast) negative feedback. The output stage is driven cooperatively by a transconductance stage (voltage to current converter).

THE RESULT: Superior sound quality, greater efficiency and higher reliability.

◆ DIAMOND (Dynamically Invariant AMplification Optimized Nodal Drive)

DIAMOND (Dynamically Invariant AMplification Optimized Nodal Drive - patent pending) is an important advance in circuit design which reduces high frequency distortion. Amplifiers which utilize a large array of output MOSFETs cause a high capacitive load on the driver stage. This load can make the high frequencies sound harsh. The DIAMOND circuit eliminates high frequency distortion by allowing the driver to operate with 20dB or more of current headroom, whereas traditional drivers have only 6dB of current headroom.

THE RESULT: Lower distortion and greater inherent stability.

◆ MEHSA (Maximum Efficiency Heat Sink Application)

The **MEHSA** (Maximum Efficiency Heat-Sink Application) is a proprietary process that yields up to 5 times better heat transfer than traditional FET mounting techniques using the exact same components. A multi-layer insulated metal substrate operating with minimal thermal resistance spreads heat both downward & outward to quickly dissipate heat from each device across the heat sink. This process combined with our DSM technology and MOSFET devices allow us to squeeze more watts per cubic inch from every output device as well as provide consistent thermal stability.

THE RESULT: Optimized power output, enhanced thermal stability, and maximum component reliability.

◆ TOPAZ (Tracking Operation Pre-Amplifier Zone)

The *TOPAZ* (Tracking Operation Pre-Amplifier Zone) circuitry solves ground loop noise problems common to automotive amplifier design. This innovative new development allows vastly improved isolation of the input signal grounds from the power supply ground of the amplifier. This is accomplished by allowing the source unit to control the potential “environment” of the entire input structure or “zone” of the amplifier. This process improves the noise rejection of the amplifier by 30-40dB – an astounding 20-100 times better than amplifiers without TOPAZ.

THE RESULT: Elimination of troublesome ground loop noise between source and amplifier.

◆ DSM (Discrete Surface Mount Technology)

The *DSM* (Discrete Surface Mount) manufacturing process combines the advantages of both discrete components and integrated circuitry. Rockford Fosgate is the only American amplifier manufacturer to have invested millions into this process. DSM components differ from conventional discrete components in different ways. They are more compact, more rugged, and they efficiently dissipate generated heat. Using them wherever appropriate allows the advantages associated with discrete circuitry to be retained while also providing room for both highly advanced processing features and generous PC board copper paths where needed. Their short lead-out structures allow maximum audio performance and highest signal-to-noise ratios to be obtained in amplifiers of desirable package size without resorting to “amplifier-on-a-chip” shortcuts. These advantages are shown below in Figure 1.

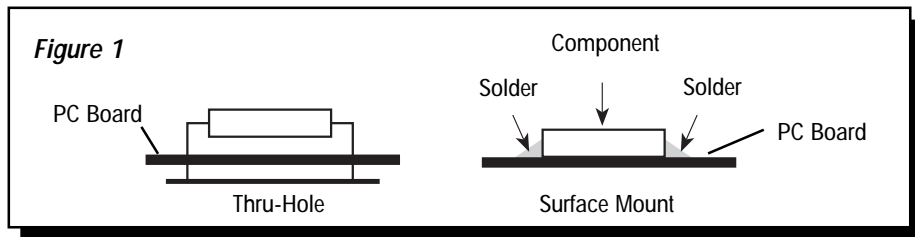

THE RESULT: Less connections, improved reliability, shorter signal paths, superior signal-to-noise ratio and awesome sonic performance.

◆ XCard (Internal Crossover)

The Power amplifiers utilize internal active crossovers. These crossovers have many performance advantages such as using discrete components for exact frequency adjustments which are far superior to potentiometers. Additionally, the *XCard* can be configured for high-pass, low-pass and full range operation. With slight modification, many crossover frequencies and slope configurations can be achieved.

THE RESULT: Increased system design flexibility with a precise electronic crossover without the limitations of conventional potentiometer designs.

◆ Stereo Pass-Thru

The *Pass-Thru* output provides a convenient source for daisy-chaining an additional amplifier without the need for extra RCA cables or “Y” adapters. The original signal(s) fed into the input jack(s) are looped back to the Pass-Thru outputs allowing less signal cable to be used. This results in cleaner system designs and reduces noise pick-up.

THE RESULT: Convenient signal level output for adding extra amplifiers.

◆ Bass EQ

The **Bass EQ** helps correct for acoustical deficiencies in the listening environment. A unique potentiometer that controls bass compensates for the lack of low frequencies present in most car environments. Unlike a conventional tone control, the Bass EQ corrects for the specific problem of poor low bass response.

THE RESULT: Provides better low bass response.

◆ Balanced Line Inputs

Using the Balanced Line Inputs provides the last word in achievable rejection of noise induced in the cable between the source and the amplifier. The differential input circuitry (Figure 2) used in the balanced input system rejects whatever signals are common to both of the shielded, twisted-pair conductors. Balanced line is universal in concert installations where the stage and mixing consoles are hundreds of feet apart. Long signal cables and electrically-noisy environments make signal integrity and noise rejection an extremely difficult challenge.

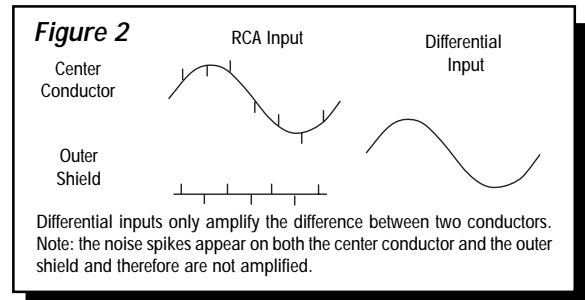

THE RESULT: Quiet transmission of audio from source to amplifier.

◆ NOMAD (NON-Multiplying Advanced Decision)

The Power amplifiers use an *analog computer process* to absolutely maximize safe output power under all operating conditions. The innovative **NOMAD (NON-Multiplying Advanced Decision)** system is the most sophisticated version of this technique ever used, bringing previously unavailable levels of accuracy, stability, temperature immunity and reliability to this critical process. NOMAD makes advanced decisions based on device voltages to precisely control the awesome levels of current available in the output MOSFETs to safe values – but only when absolutely needed.

THE RESULT: Extremely fast protection system that always protects the amplifier and never degrades the sound.

◆ MOSFET Devices (Metal Oxide Semiconductor Field Effect Transistor)

Rockford Fosgate is one of the few manufacturers in any of the sound communities to utilize MOSFET devices in both the **power supply** and the **output stages**. **MOSFET (Metal Oxide Semiconductor Field Effect Transistor)** devices offer several important inherent advantages over the 30 year old technology of bi-polar design. These advantages include: thermal stability, switching speed, ultra low output impedance and wider bandwidth linearity. In addition, MOSFET and vacuum tubes share many important operating characteristics. However, the MOSFET device is much faster, wider in bandwidth, measurably lower in distortion and far more linear than vacuum tubes.

THE RESULT: Operational characteristics of vacuum tubes without the performance limitations of tube design.

DESIGN FEATURES

1. **Cast Aluminum Chrome Heatsink** – The cast aluminum heatsink of the Punch Power amplifier dissipates heat generated by the amplifier's circuitry. The inherent advantage of casting provides a 30% improvement of cooling over conventional extrusion heatsink designs.
2. **End Caps** – The unique end caps conceal the wiring and input cables, giving the amplifier a clean “stealth” look.

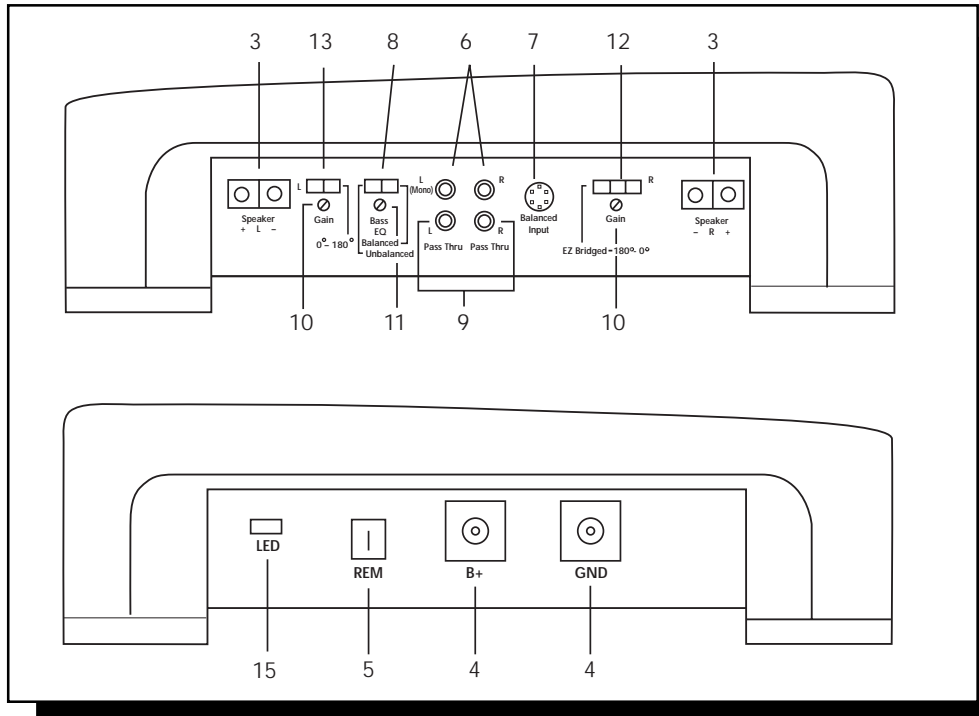

3. **Speaker Terminals** – The heavy duty, gold-plated terminal block connectors (+ and -) will accept wire sizes from 8 AWG to 18 AWG. These gold-plated connectors are immune to corrosion that can cause signal deterioration.
4. **Power Terminals** – The heavy duty, gold-plated power and ground connectors will accommodate 4 AWG wire for maximum input current capability.
5. **REM Terminal** – This gold-plated spade terminal is used for the AP (auto power) or remote turn on of the amplifier.
6. **RCA Input Jacks** – The industry standard RCA jack provides an easy connection for signal level input. They are gold-plated to resist the signal degradation caused by corrosion.
7. **Balanced Line Input**– This input will allow the Balanced Line Transmitter (BLT) or any balanced Rockford Fosgate source unit/signal processor to be used in conjunction with the amplifier to provide better noise rejection.
8. **Signal Input Switch** – This switch allows selection of either the RCA or Balanced Line inputs.
9. **RCA Pass-Thru Jacks** – The Pass-Thru provides a convenient source for daisy chaining an additional amplifier, eliminating the need for “Y” adapters. The original signal(s) fed into input jack(s) are looped back to the Pass-Thru output(s).
10. **Input Sensitivity Controls** – The input level controls are preset to match the output of most source units. They can be adjusted to match output levels from a variety of source units.

11. **Bass EQ Control** – The Bass EQ allows a narrow band adjustment of up to +18dB centered at 45Hz. The bass boost can be bypassed by turning the control to its minimum or counterclockwise position.
12. **E-Z Bridge Switch / 0°-180° Phase Switch** – This dual purpose switch enables you to E-Z bridge the amplifier or invert the signal phase of the right channel.
13. **Phase Switch** – This switch enables you to easily invert the phase of the left channel without having to disconnect the speaker wires.
14. **Internal Crossovers** – These built-in crossover cards are configurable for a multitude of operating frequencies. The orientation of the card in its socket determines its function of high-pass, low-pass or full range operation.
15. **LED Power Indicator** – The LED gives a visual indication of the status of the amplifier, lighting when the unit is turned on.

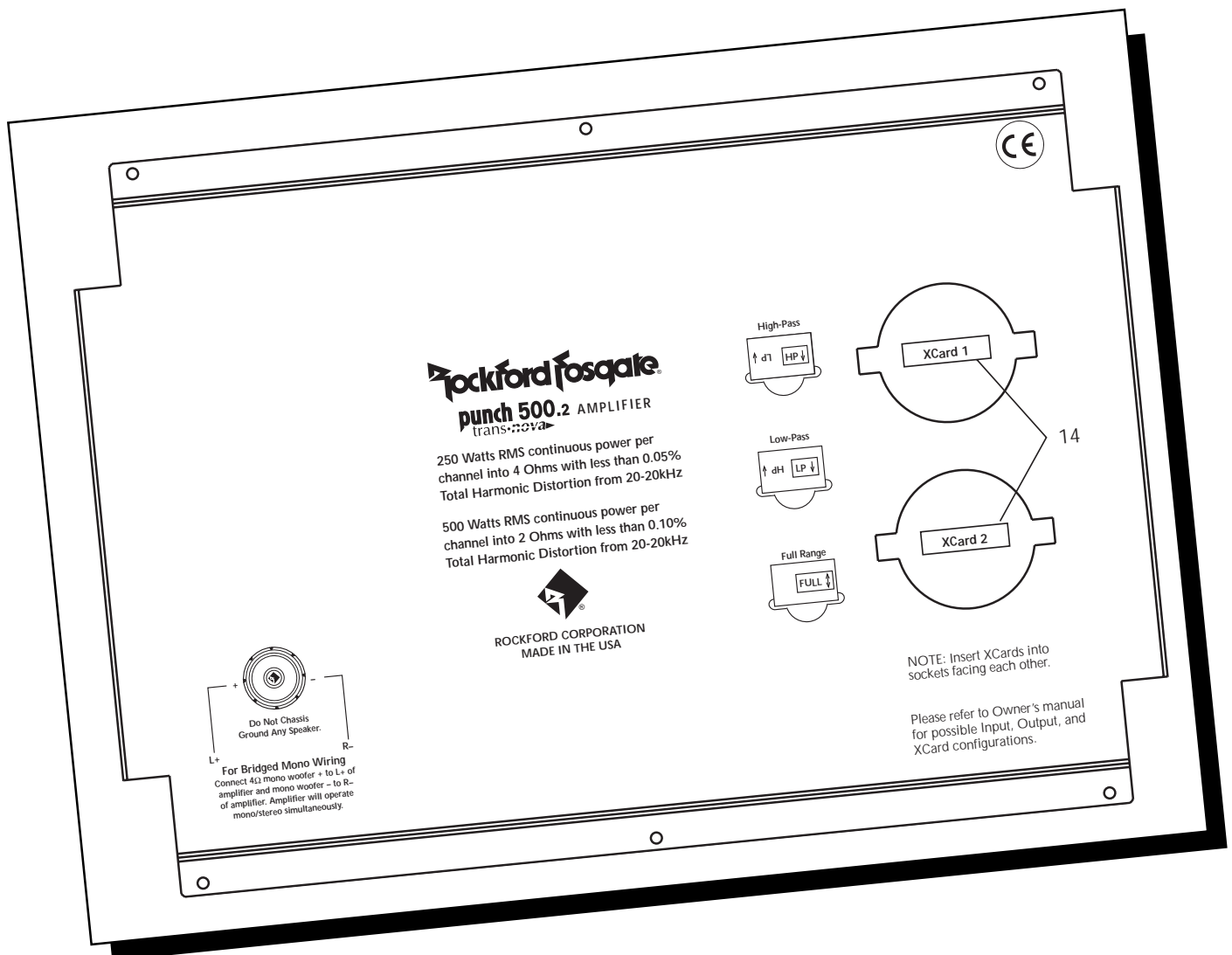

INSTALLATION CONSIDERATIONS

Tools Needed

The following is a list of tools you will need for installing the Punch Power amplifier:

Allen wrenches 9/64" , 3/32" & 1/8" (included)	Wire Cutters
Wire strippers	Voltmeter
Battery post wrench	Wire crimpers
Electric hand drill and assorted bits	Assorted connectors

This section focuses on some of the vehicle considerations for installing your new Punch amplifier. Checking your battery and present sound system, as well as pre-planning your system layout and best wiring routes will save installation time. When deciding on the layout of your new system, be sure that each component will be easily accessible for making adjustments.

Before beginning any installation, be sure to follow these simple rules:

1. Carefully read and understand the instructions before attempting to install the amplifier.
2. **For safety**, disconnect the negative lead from the battery prior to beginning the installation.
3. For easier assembly, we suggest you run all wires prior to mounting your amplifier in place.
4. Route all of the RCA cables close together and away from any high current wires.
5. Use high quality Connecting Punch accessories for a reliable installation and to minimize signal or power loss.
6. **Think before you drill!** Be careful not to cut or drill into gas tanks, fuel lines, brake or hydraulic lines, vacuum lines or electrical wiring when working on any vehicle.
7. Never run wires underneath the vehicle. Running the wires inside the vehicle provides for best protection.
8. Avoid running wires over or through sharp edges. Use rubber or plastic grommets to protect any wires routed through metal, especially the firewall.
9. **ALWAYS** protect the battery and electrical system from damage with proper fusing. Install a fuseholder and fuse on the +12V power wire within 18" (45.7cm) of the battery terminal.
10. When grounding to the chassis of the vehicle, scrape all paint from the metal to ensure a good, clean ground connection. Grounding connections should be as short as possible and always be connected to metal that is welded to the main body, or chassis, of the vehicle.

MOUNTING LOCATIONS

The mounting location and position of your amplifier will have a great effect on its ability to dissipate the heat generated under normal operation. The design of our cast aluminum heatsink serves to easily dissipate the heat generated over a wide range of operating conditions. However, to maximize the performance of your amplifier, care should be taken to ensure adequate ventilation.

Trunk Mounting

Mounting the amplifier vertically on a surface with the fin grooves running up and down will provide the best cooling of the amplifier.

Mounting the amplifier on the floor of the trunk will work but provides less cooling capability than vertical mounting.

Mounting the amplifier upside down to the rear deck of the trunk will not provide proper cooling and will severely affect the performance of the amplifier and is strongly **not** recommended.

Passenger Compartment Mounting

Mounting the amplifier in the passenger compartment will work as long as you provide a sufficient amount of air for the amplifier to cool itself. If you are going to mount the amplifier under the seat of the vehicle, you must have at least 1" (2.54cm) of air gap around the amplifier's heatsink.

Mounting the amplifier with less than 1" (2.54cm) of air gap around the heatsink in the passenger compartment will not provide proper cooling and will severely affect the performance of the amplifier and is strongly **not** recommended.

Engine Compartment Mounting

Rockford Fosgate amplifiers should **never** be mounted in the engine compartment. Not only will this void your warranty but could create an embarrassing situation caused by the ridicule from your friends.

BATTERY AND CHARGING

Amplifiers will put an increased load on the vehicle's battery and charging system. We recommend checking your alternator and battery condition to ensure that the electrical system has enough capacity to handle the increased load of your stereo system.

NOTE: This amplifier utilizes a large array of power supply capacitance and can draw substantial current at turn-on. The dashboard BATTERY VOLTAGE and/or ALTERNATOR CHARGE lamp may illuminate for a brief period while momentarily recharging the capacitor bank. This may be most noticeable when the amplifier is off for at least a day or two and is considered normal operation.

WIRING THE SYSTEM

CAUTION: Avoid running power wires near the low level input cables, antenna, power leads, sensitive equipment or harnesses. The power wires carry substantial current and could induce noise into the audio system.

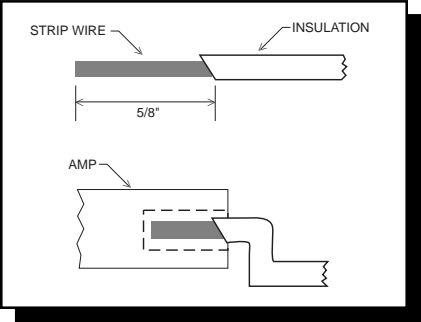
1. Configure the internal XCard crossovers prior to installation. Refer to the XCard Configurations on pages 14 & 15 for further information.
 2. Plan the wire routing. Take care when running signal level RCA cables to keep them close together but isolated from the amplifier's power cables and any high power auto accessories, especially electric motors. This is done to prevent coupling the noise from radiated electrical fields into the audio signal. When feeding the wires through the firewall or any metal barrier, protect them with plastic or rubber grommets to prevent short circuits. Leave the wires long at this point to adjust for a precise fit at a later time.
 3. Prepare the **Power** cable for attachment to the amplifier by stripping 5/8" of insulation from the end of the wire. The use of 4 gauge power cable can interfere with the installation of the end caps. Proper wire dress can prevent this from occurring. To prevent the wire from fraying, strip the insulation at a 45° angle. Insert the bared wire into the B+ terminal with the long side of the insulation on the top. Bend the cable down at a 90° angle. Tighten the set screw to secure the cable in place. ***We recommend using 4 gauge cables for power and for ground. This will give you the best performance possible.***
- 
4. Strip 3/8" from the battery end of the power cable and crimp a large ring terminal to the cable. Use the ring terminal to connect to the battery positive terminal. **Do not install the fuse at this time.**
 5. Prepare a length of cable to be used for the ground connection. Strip 5/8" of insulation from the end of the cable as described above and connect to the ground terminal of the amplifier. Prepare the chassis ground by scraping any paint from the metal surface and thoroughly clean the area of all dirt and grease. Strip the other end of the cable and attach a ring connector. Fasten the cable to the chassis using a non-anodized screw and a star washer.
 6. Prepare the REM turn-on wire for connection to the amplifier by stripping 1/4" of insulation from the wire end and crimping an insulated spade connector in place. Slide the connector over the REM terminal on the amplifier. Connect the other end of the REM wire to a switched 12 volt positive source. The switched signal is usually taken from the source unit's auto antenna or the accessory lead. If the source unit does not have these outputs available, the recommended solution is to wire a mechanical switch in line with a 12 volt source to activate the amplifier.
 7. Securely mount the amplifier (with supplied screws) to the vehicle or amp rack. Be careful not to mount the amplifier on cardboard or plastic panels. Doing so may enable the screws to pull out from the panel due to road vibrations or sudden vehicle stops.
 8. Connect the source signal to the amplifier by plugging the RCA cables into the input jack(s) at the amplifier. If using Balanced Line Inputs, refer to pages 19 & 20.
 9. Connect the speakers. Strip the speaker wires 5/8" and insert into the appropriate terminal on the amplifier. Insert the bared wire into the speaker terminal and tighten the set screw to secure into place. Be sure to maintain proper speaker polarity. ***DO NOT chassis ground any of the speaker leads as unstable operation may result.***
 10. Perform a final check of the completed system wiring to ensure that all connections are accurate. Check all power and ground connections for frayed wires and loose connections which could cause problems from road vibrations.

11. After the final inspection is complete, install the power fuse and enjoy listening. During the initial listening period, you may need to “fine tune” any phasing and level settings within your particular vehicle. To aid in this procedure, play a track with high musical content and cruise around your neighborhood. After fully evaluating the transient response of your system and making any final adjustments, all your neighbors within a 1 mile radius will assume that you have just successfully completed another upgrade to your audio system for which they will probably spill thumbtacks on your driveway.

NOTICE!

Amplifiers using the trans•nova topology improve in sound quality after warming up. We recommend operating the amplifier for approximately 15 minutes prior to evaluation under judging criteria or tune-ups to establish its normal operating temperature.

** Your friends will call it MAGIC, you can call it Rockford technology! **

USING PASSIVE CROSSOVERS

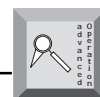

A passive crossover is a circuit that uses capacitors and/or coils and is placed on speaker leads between the amplifier and speaker. The crossover delegates a specific range of frequencies to the speaker for optimum driver performance. A crossover network can perform one of three functions: High-Pass (capacitors), Low-Pass (inductors or coils) and Bandpass (combination of capacitor and coil).

The most commonly used passive crossover networks are 6dB/octave systems. These are easy to construct and require one component per filter. Placing this filter in series with the circuit will reduce power to the speaker by 6dB/octave above or below the crossover point depending on whether it is a high-pass or low-pass filter. More complex systems such as 12dB/octave or 18dB/octave can cause impedance problems if not professionally designed.

Passive crossovers are directly dependent upon the speaker's impedance and component value for accuracy. When passive crossover components are used in multiple speaker systems, the crossover's effect on the overall impedance should be taken into consideration along with the speaker's impedance when determining amplifier loads.

TABLE OF CROSSOVER COMPONENT VALUES

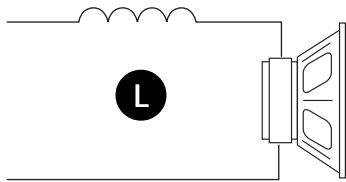
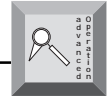

6dB/Octave Low-Pass

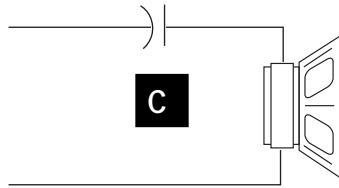

6dB/Octave High-Pass

Freq. (Hertz)	Speaker Impedance					
	2 OHMS		4 OHMS		8 OHMS	
	L	C	L	C	L	C
80	4.1mH	1000µF	8.2mH	500µF	16mH	250µF
100	3.1mH	800µF	6.2mH	400µF	12mH	200µF
130	2.4mH	600µF	4.7mH	300µF	10mH	150µF
200	1.6mH	400µF	3.3mH	200µF	6.8mH	100µF
260	1.2mH	300µF	2.4mH	150µF	4.7mH	75µF
400	.8mH	200µF	1.6mH	100µF	3.3mH	50µF
600	.5mH	136µF	1.0mH	68µF	2.0mH	33µF
800	.41mH	100µF	.82mH	50µF	1.6mH	26µF
1000	.31mH	78µF	.62mH	39µF	1.2mH	20µF
1200	.25mH	66µF	.51mH	33µF	1.0mH	16µF
1800	.16mH	44µF	.33mH	22µF	.68mH	10µF
4000	.08mH	20µF	.16mH	10µF	.33mH	5µF
6000	51µH	14µF	.10mH	6.8µF	.20mH	3.3µF
9000	34µH	9.5µF	68µH	4.7µF	.15mH	2.2µF
12000	25µH	6.6µF	51µH	3.3µF	100µH	1.6µF

6 dB/Octave High-Pass and Low-Pass Filters

L = Low-Pass (Inductor)
C = High-Pass (Capacitor)

For more information, see your Authorized Rockford Fosgate Dealer.

USING THE XCARD

The crossover functions are controlled through the use of an XCard and can be set for high-pass, low-pass or full range operation. The XCard shipped with your amplifier is set for Full Range. Each crossover card has two faces: one face operates Full Range, the other has arrows to indicate the edge for selecting HP (high-pass) or LP (low-pass) operation. Orient the card with the desired operating edge, indicated by the arrow, toward the socket terminals inside the amplifier. Firmly, but carefully, plug the card into the socket.

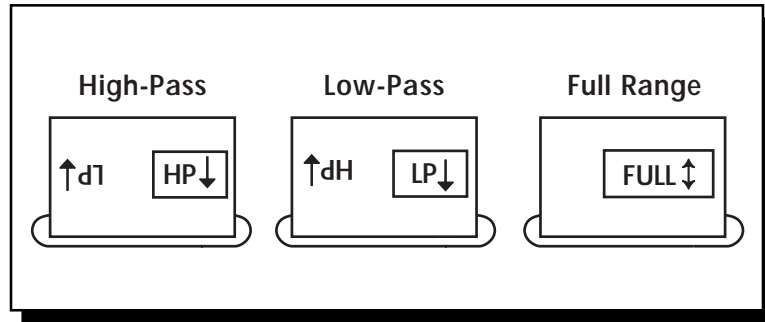

CUSTOMIZING THE XCARD



The crossover point can be altered by changing the 4 resistor values. Use the following formula to select the appropriate resistor value to be placed on the XCard.

$$\frac{3386}{f_0} = R \text{ (in } k\Omega \text{) for } .047\mu\text{f cap}$$

$$\frac{7234}{f_0} = R \text{ (in } k\Omega \text{) for } .022\mu\text{f cap}$$

The actual formula is: $R = \frac{1}{2\pi f_0 c}$

Where: $R = \Omega$
 f_0 = desired crossover frequency
 c = capacitor in farads
 ex: $.047 \times 10^{-6}$ for $.047\mu\text{f cap}$

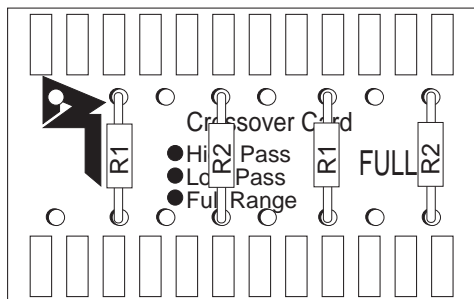

XCARD RESISTOR CHART

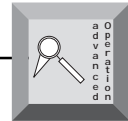

Our tests have shown that using 0.047 μ F capacitors for frequencies below 100Hz, and 0.022 μ F capacitors for frequencies above 100Hz, result in more linear crossover control. Refer to the Specifications page to determine the capacitor value of each supplied XCard.

Butterworth Alignment $Q = .707$
 1% resistors used with 0.047 μ F capacitors

Frequency	R1	R2
20Hz	169k Ω	169k Ω
25Hz	133k Ω	133k Ω
30Hz	110k Ω	110k Ω
35Hz	95.3k Ω	95.3k Ω
40Hz	84.5k Ω	84.5k Ω
45Hz	75k Ω	75k Ω
50Hz	68.1k Ω	68.1k Ω
55Hz	61.9k Ω	61.9k Ω
60Hz	56.2k Ω	56.2k Ω
65Hz	52.3k Ω	52.3k Ω
70Hz	48.7k Ω	48.7k Ω
75Hz	45.3k Ω	45.3k Ω
80Hz	42.2k Ω	42.2k Ω
85Hz	40.2k Ω	40.2k Ω
90Hz	37.4k Ω	37.4k Ω
200Hz	16.9k Ω	16.9k Ω
300Hz	11.3k Ω	11.3k Ω
400Hz	8.45k Ω	8.45k Ω
500Hz	6.65k Ω	6.65k Ω
600Hz	5.62k Ω	5.62k Ω
700Hz	4.75k Ω	4.75k Ω
800Hz	4.22k Ω	4.22k Ω
900Hz	3.74k Ω	3.74k Ω
1.0kHz	3.40k Ω	3.40k Ω
1.2kHz	2.80k Ω	2.80k Ω
2kHz	1.69k Ω	1.69k Ω
3kHz	1.10k Ω	1.10k Ω
4kHz	845 Ω	845 Ω
5kHz	665 Ω	665 Ω
6kHz	562 Ω	562 Ω
7kHz	487 Ω	487 Ω
8kHz	422 Ω	422 Ω

Butterworth Alignment $Q = .707$
 1% resistors used with 0.022 μ F capacitors

Frequency	R1	R2
20Hz	357k Ω	357k Ω
25Hz	287k Ω	287k Ω
30Hz	237k Ω	237k Ω
35Hz	205k Ω	205k Ω
40Hz	178k Ω	178k Ω
45Hz	162k Ω	162k Ω
50Hz	143k Ω	143k Ω
55Hz	130k Ω	130k Ω
60Hz	121k Ω	121k Ω
65Hz	110k Ω	110k Ω
70Hz	102k Ω	102k Ω
75Hz	95.3k Ω	95.3k Ω
80Hz	90.9k Ω	90.9k Ω
85Hz	84.5k Ω	84.5k Ω
90Hz	80.6k Ω	80.6k Ω
200Hz	35.7k Ω	35.7k Ω
300Hz	23.7k Ω	23.7k Ω
400Hz	17.8k Ω	17.8k Ω
500Hz	14.3k Ω	14.3k Ω
600Hz	12.1k Ω	12.1k Ω
700Hz	10.2k Ω	10.2k Ω
800Hz	9.9k Ω	9.9k Ω
900Hz	86k Ω	86k Ω
1.0kHz	7.15k Ω	7.15k Ω
1.2kHz	6.04k Ω	6.04k Ω
2.0kHz	3.57k Ω	3.57k Ω
3.0kHz	2.37k Ω	2.37k Ω
4.0kHz	1.76k Ω	1.76k Ω
5.0kHz	1.43k Ω	1.43k Ω
6.0kHz	1.21k Ω	1.21k Ω
7.0kHz	10.2k Ω	10.2k Ω
8.0kHz	909 Ω	909 Ω

XCARD CONFIGURATIONS

Bypassing the Crossover

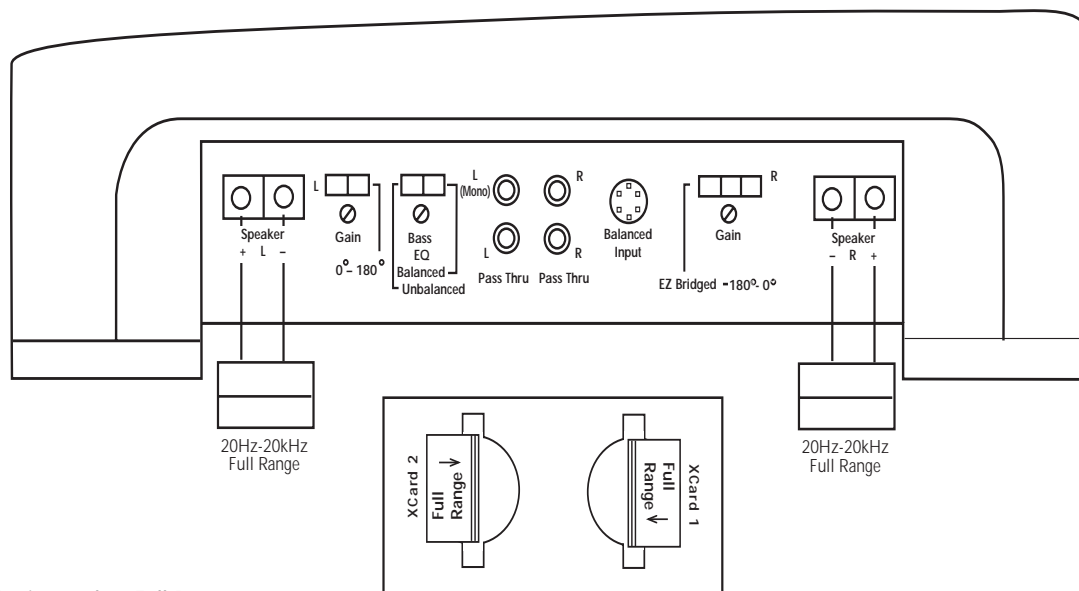

- XCard 1 inserted as Full Range
- XCard 2 inserted as Full Range

Configuring a 12dB/octave Filter

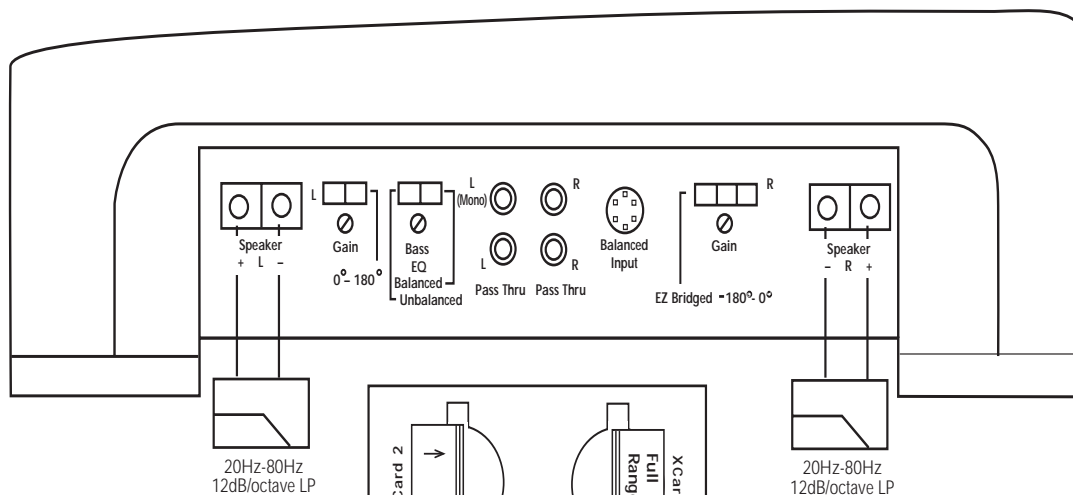

- XCard 1 inserted as Full Range
- XCard 2 inserted as HP or LP

Configuring a 24dB/octave Filter

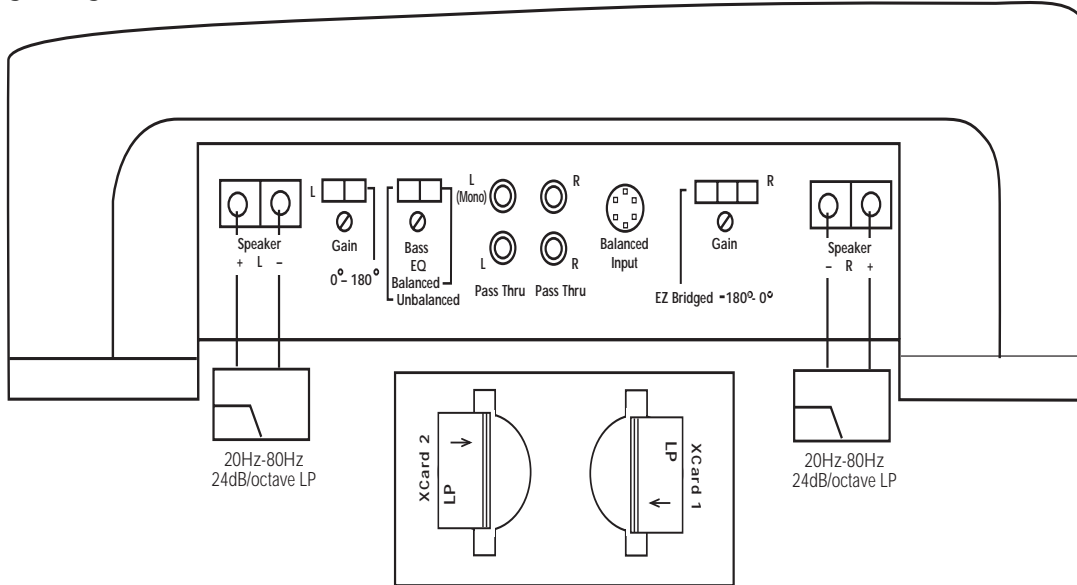

- XCards 1 & 2 inserted identically as HP or LP
NOTE: Both XCards must be customized to the same frequency for proper 24dB/octave operation.

Configuring a 12dB/octave Bandpass Filter

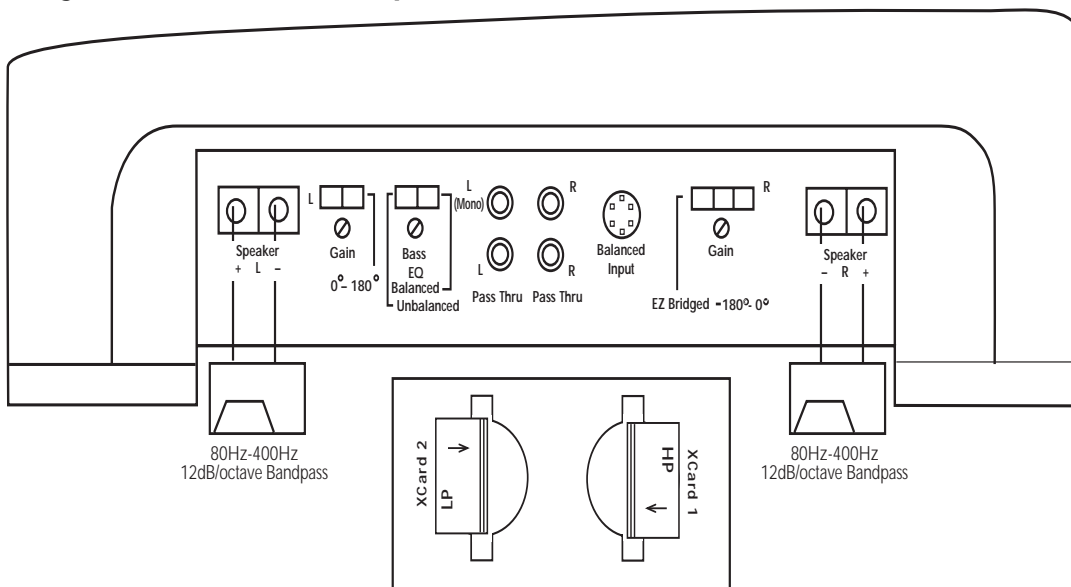

- XCard 1 inserted as HP
 - XCard 2 inserted as LP
- NOTE: The amplifier is shipped with 80Hz XCards.x2 At least one of the XCards must be customized to enable proper bandpass operation. Refer to "Using the XCard" on page 12 for more information or contact your local Authorized Rockford Fosgate Dealer for customized XCards.**

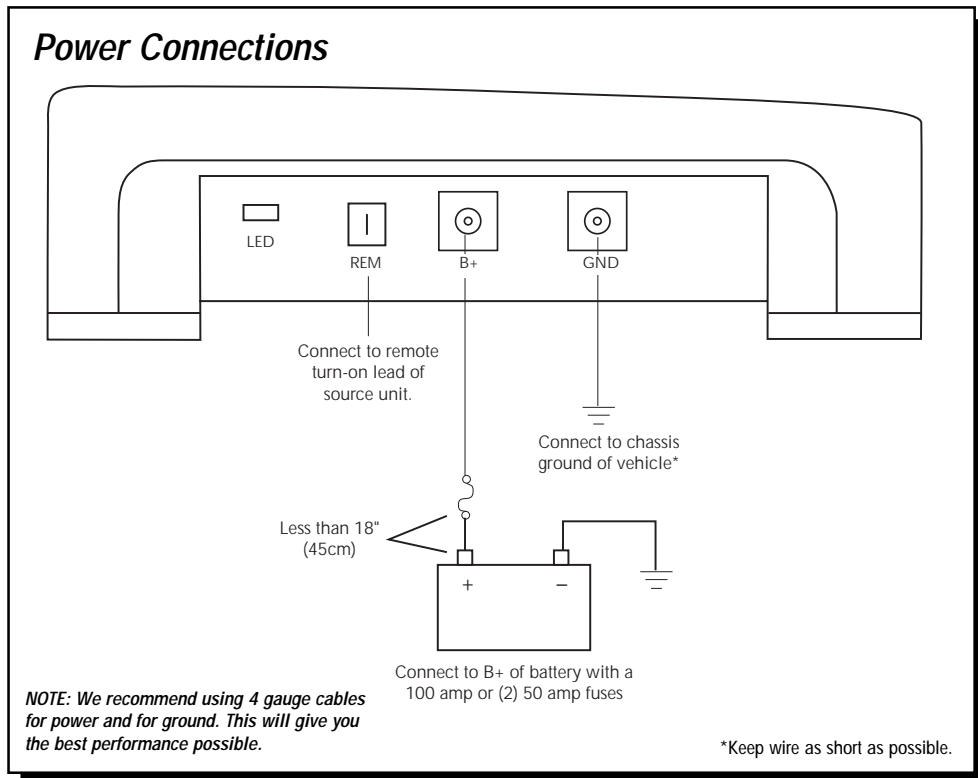

Stereo Operation

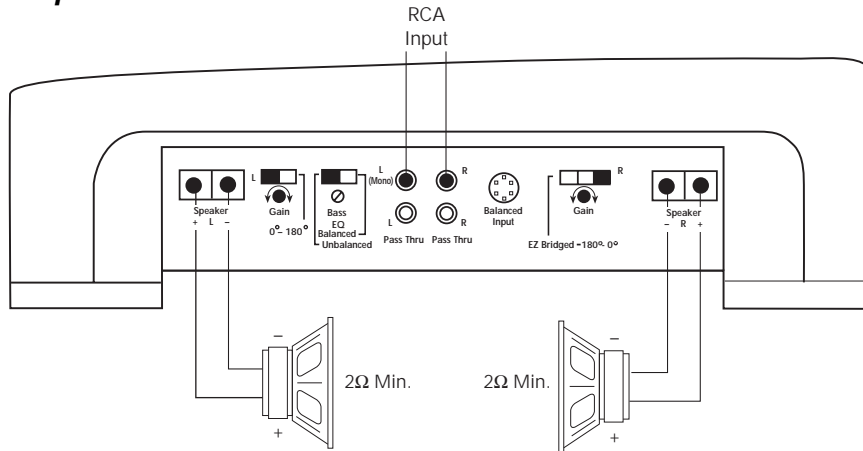

- RCA inputs are connected to both *left and right* channels
- Signal Input Switch selected to *Unbalanced* for RCA input
- Left Phase Switch set to 0°
- Right Phase Switch set to 0°
- Gain for left and right channels *operate independently*
- Impedance for *each channel* should be 2Ω minimum
- XCard can be *High-Pass, Low-Pass* or *Full Range* position

Stereo/Mono Operation

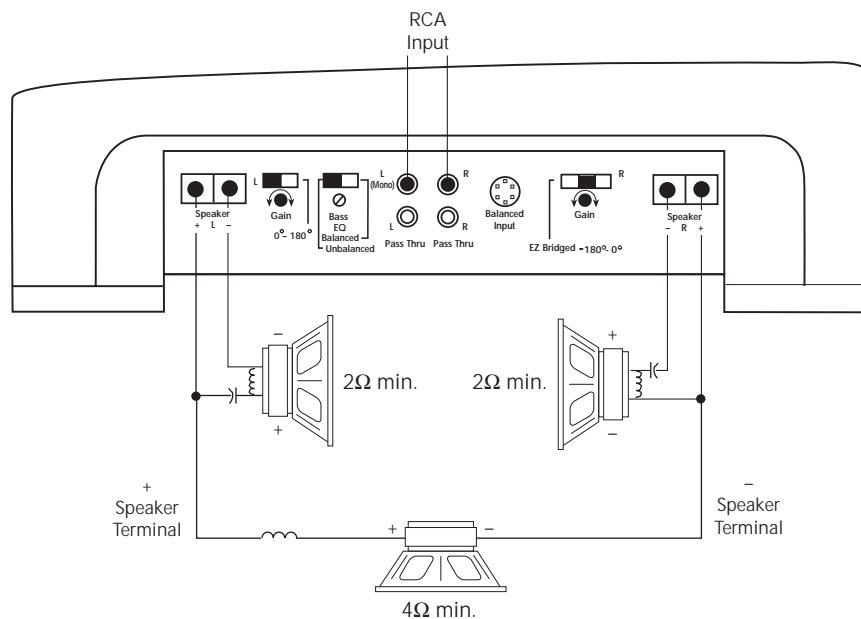

- RCA inputs are connected to both *left and right* channels
- Signal Input Switch selected to *Unbalanced* for RCA input
- Left Phase Switch set to 0°
- Right Phase Switch set to 180° for stereo/mono operation
- All speaker polarity on right channel is inverted to correct for signal phase
- Gain for left and right channels set *equally* to balance the subwoofer
- Impedance for *each channel* should be 2Ω minimum
- Impedance for *bridged channel* should be 4Ω minimum
- XCard is in *Full Range* position
- Passive crossovers are needed for proper stereo/mono operation



Bridged Operation

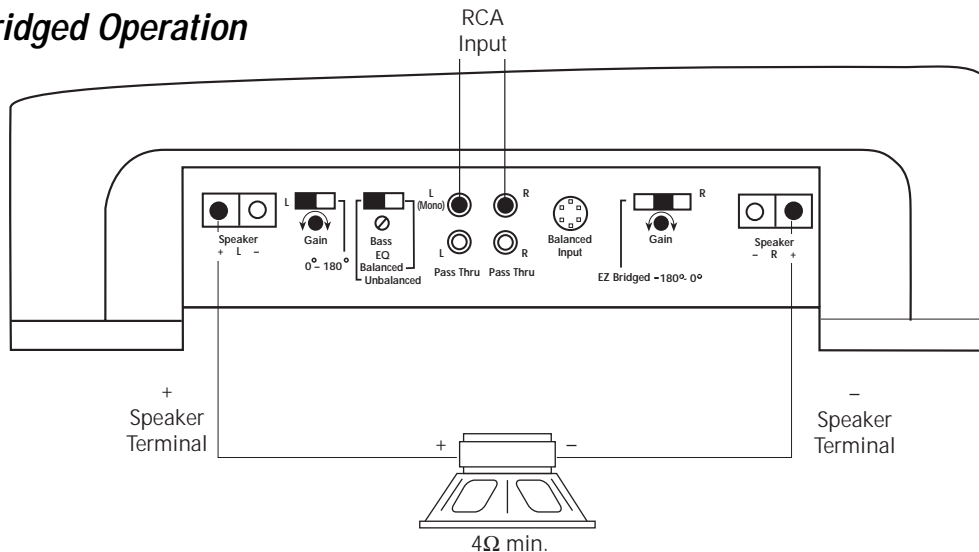

- RCA inputs are connected to both *left and right* channels
- Signal Input Switch selected to *Unbalanced* for RCA input
- Left Phase Switch set to 0°
- Right Phase Switch set to 180°
- Inverting the right signal will allow the bridged woofer to operate correctly
- Gain for left and right channels *set equally* to balance the subwoofer
- Impedance for *bridged channel* should be 4Ω minimum
- XCard is in *High-Pass, Low-Pass* or *Full Range* position

EZ-Bridged Operation

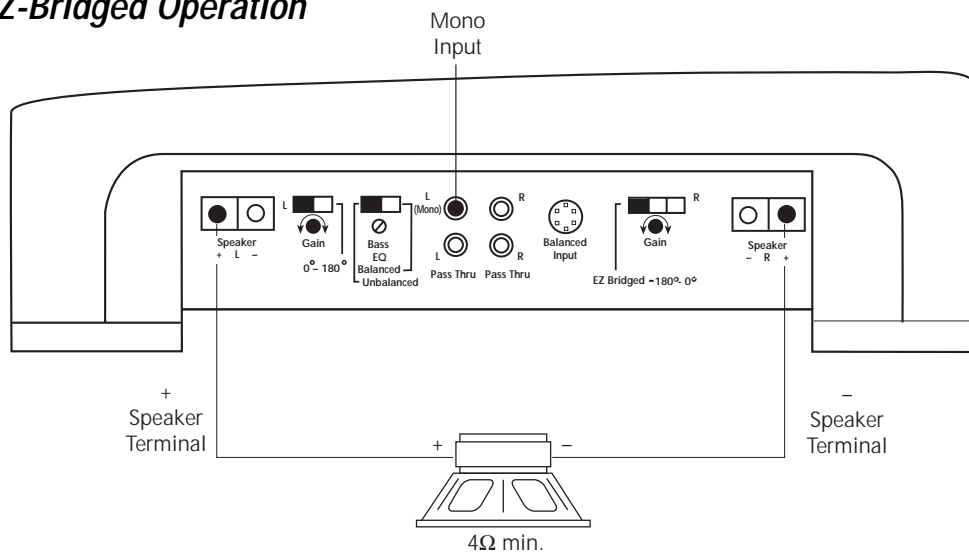

- RCA input is connected to *L (Mono)* input
- Signal Input Switch to *Unbalanced* for RCA input
- Left Phase Switch at 0°
- Right Phase Switch set to *E-Z Bridge* for the following to occur:
 - L (Mono) RCA input to drive both the left and right channels
 - Left Gain will control both the left and right channels
 - Right Phase will be inverted 180° which will allow the bridged woofer to operate correctly
- Impedance for *bridged channel* should be 4Ω minimum
- XCard is in the *High-Pass, Low-Pass* or *Full Range* position

USING THE BALANCED LINE INPUT

The Balanced Line Inputs can be utilized with the optional Balanced Line Transmitter. Unlike standard RCA cables that use two wires to carry the audio signal and ground, balanced lines use three. In a balanced line, the output signal and its inverted replica travel down a pair of wires where the ground connects via the shield. As the amplifier receives the signals, it cancels out whatever signals are common to both wires. The use of balanced lines helps in preventing radiated noise pickup in the signal cables and has been proven effective in studio installation where long cable runs and magnetic fields make maintaining signal integrity difficult.

Connecting the BLT

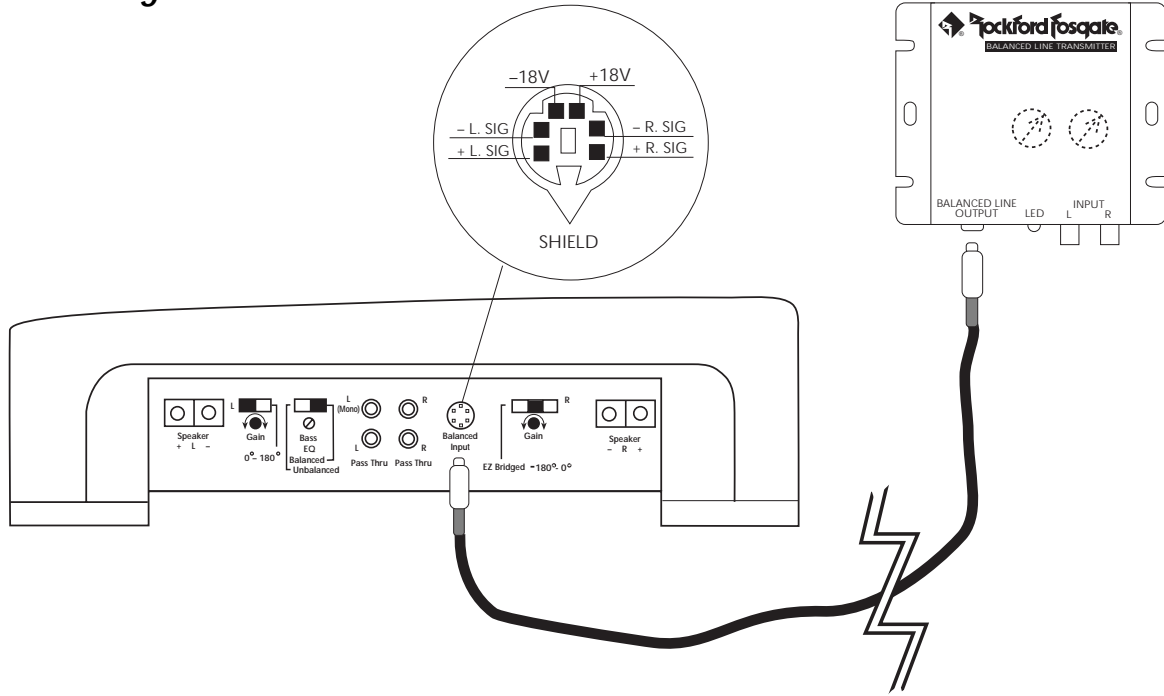

- Signal Input Switch to *Balanced* for Balanced Line Input
- Gain for Left and Right channels set to *minimum*

CAUTION!! You must turn the gain controls to minimum when using the Balanced Line Transmitter. If the input gains need to be adjusted, this can now be done in the Balanced Line Transmitter.

Level Setting the BLT

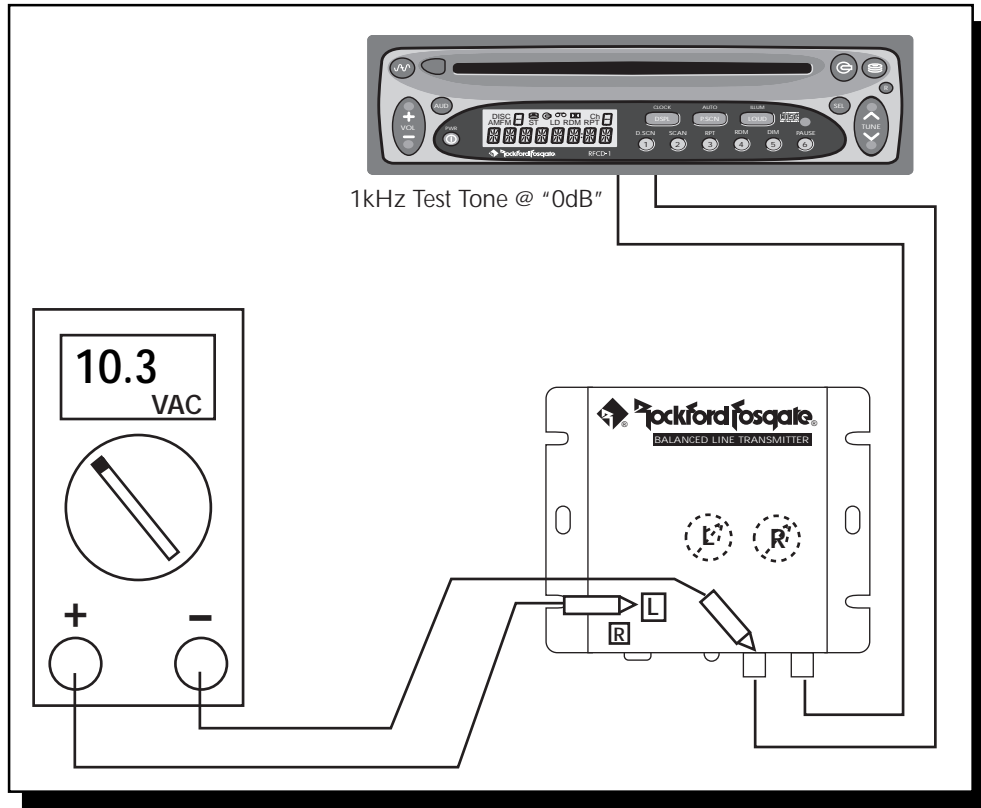

- Disconnect Speaker(s) from the amplifier
- CD Software used to set levels is a test tone of 1kHz at "0dB" or "All Bits High"
- Source Unit set to 3/4 volume (or maximum unclipped output)
- Remove BLT Cover to access *test pads* and *gain pots*
- AC Voltmeter set to AC Volts
- AC Voltmeter "-" connected to RCA shield of BLT
- AC Voltmeter "+" connected to *test pad* inside the BLT
- Adjust BLT Gain from 3.25 VRMS min. to 10.3 VRMS max per test pad (see chart below)
Be sure the time index reads greater than 30 seconds on source unit.

Gain Overlap	BLT Output (AC Volts)	Performance Characteristics
+0dB*	3.25 VRMS	Best S/N Ratio, Reduced SPL
+5dB	5.8 VRMS	Good S/N Ratio & SPL
+10dB	10.3 VRMS	Best Compromise between S/N Ratio & SPL

*Absence of gain overlap will reduce SPL and may not permit amplifier to reach full output power due to various CD software.

ROCKFORD FOSGATE ACCESSORIES



Balanced Line Transmitter (FG-BLT)

The Balanced Line Transmitter converts unbalanced (RCA) signals from the source unit to balanced signals. The BLT improves sound quality in the system by eliminating noises generated by vehicle electrical systems. The BLT is available for Rockford Fosgate products that offer a balanced input.

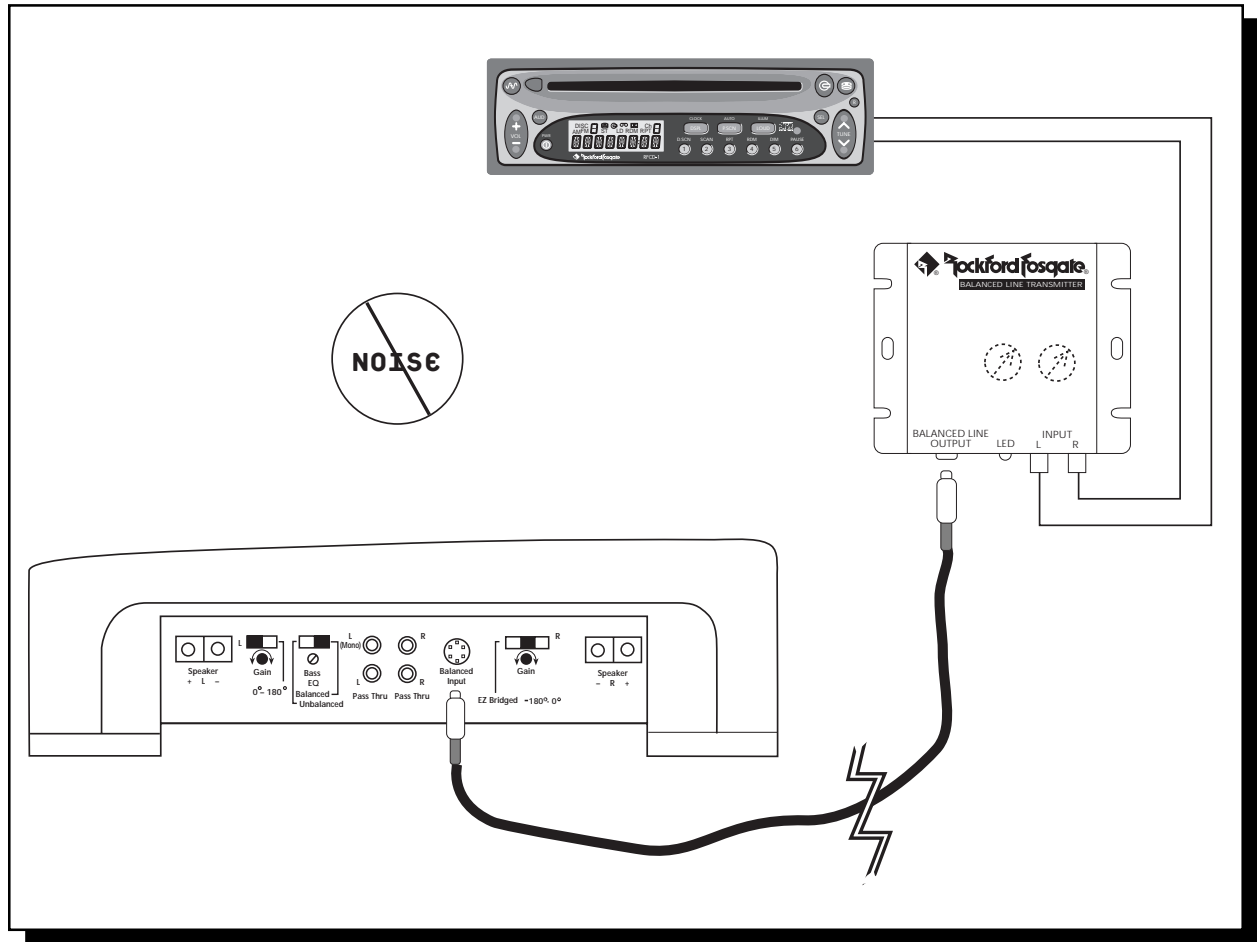

ATTENTION: We recommend your Authorized Rockford Fosgate Dealer install your new accessory.



Energy Storage Capacitors

Energy Storage Capacitors are used to provide extra current needed by amplifiers to reproduce musical transients. The capacitors also have the natural ability to filter AC ripple caused by the alternator, reducing the chance of noise in the system. The capacitors are available in a variety of values and will maximize both the sound quality and performance that Rockford Fosgate amplifiers can deliver.

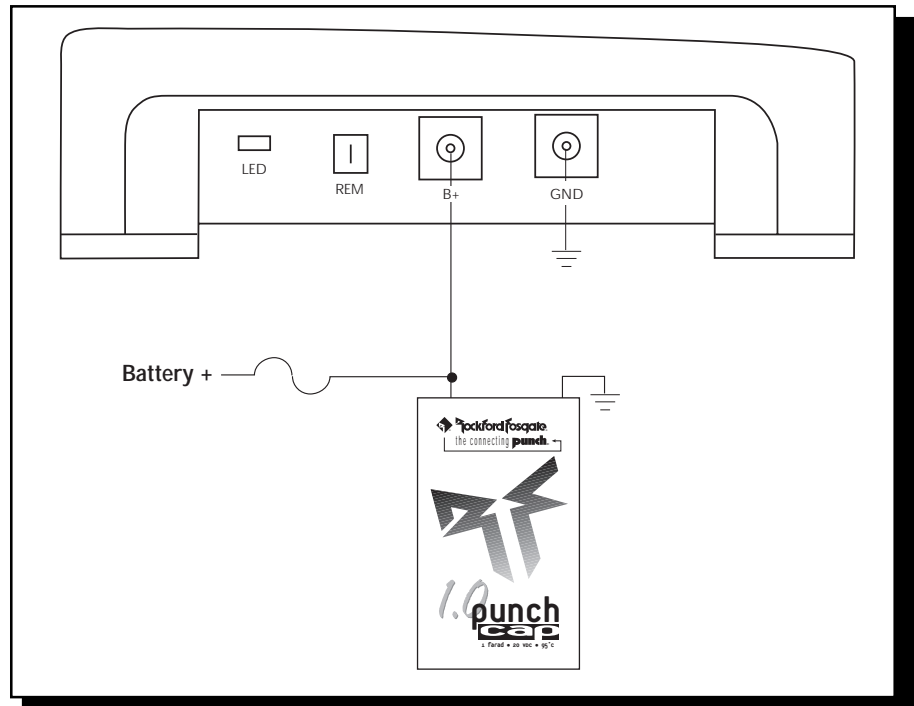

- Recommended capacitance is 1 farad per 1000 watts



XCard Crossovers

Additional crossover card frequencies are available for specialized requirements. You can get the following XCards from your Authorized Rockford Fosgate Dealer.

XM50 = 50Hz	XM200 = 200Hz
XM70 = 70Hz	XM275 = 275Hz
XM80 = 80Hz	XM400 = 400Hz
XM100 = 100Hz	XM4.5k = 4,500Hz
XM150 = 150Hz	XM6.5k = 6,500Hz
	XM00 = Blank card for custom crossover

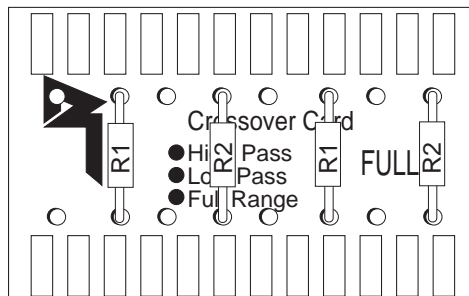

ATTENTION: We recommend your Authorized Rockford Fosgate Dealer install your new accessory.

TROUBLESHOOTING

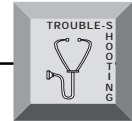

Symptom	Diagnosis	Remedy
Amplifier does not turn on. (Power LED is off)	Voltage applied to the REM terminal of the amplifier is not between 10.5 and 15.5 volts or there is no voltage present.	Check the alternator, battery, fuse, and wiring and repair as necessary. If the voltage is above 15.5 volts, have the electrical system inspected by an authorized car service center.
	Voltage to the B+ terminal of the amplifier is not between 10.5 and 15.5 volts or there is no voltage present.	Check the alternator, battery, fuse, and wiring and repair as necessary. If the voltage is above 15.5 volts, have the electrical system inspected by an authorized car service center.
	Amplifier is not properly grounded.	Check wiring and repair as necessary.
Amplifier has no sound. (Power LED is on)	RCA Input from source unit is not connected or not functioning properly.	Check connections, substitute with known working source and cables and repair or replace as necessary.
	When using the BLT, Balanced Line Input from BLT is not connected or not functioning properly.	Check connections, substitute with known working BLT and cables and repair or replace as necessary.
	Unbalanced/Balanced Line switch is not selected for corresponding input.	Check switch position and correct as necessary.
	Amplifier is in E-Z Bridge operation but incorrect signal input, speaker wiring, and/or left channel 180° phase selection is chosen.	Check signal, speaker wiring, and left channel phase selection installation and correct as needed.
	XCards are missing or not placed properly in crossover slots.	Check XCard positions and repair or replace as necessary.
	Speaker leads are shorted to each other or to the chassis of the vehicle.	Disconnect existing speakers and test with known working speakers and wires. If amplifier plays, check and repair wiring and installation of speakers as necessary.
	Speakers are defective.	Disconnect existing speakers and test with known working speakers. If amplifier plays, check and repair speakers as necessary.

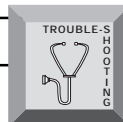

Symptom	Diagnosis	Remedy
Speaker Output Low or Distorted	Input gain(s) for amplifier incorrectly set.	Readjust input gains of amplifier.
	Source unit output too low or source unit has no output.	Check system with known working source and repair or replace original source as needed.
	Phase selection of amplifier incorrectly selected or speakers wired out of polarity from the left to right channel.	Check speaker polarity and phase switch position and correct as needed.
	XCards are missing or not placed properly in crossover slots.	Check XCard positions and repair or replace as necessary.
	Low battery voltage or large voltage drops to the amplifier under load.	Check the alternator, battery, fuse or circuit breaker and power and ground wiring and repair as necessary.
Amplifier Noise (Turn-on Pop)	Voltage spike from output of preceding component is entering amplifier through input signal.	Disconnect input signal to amplifier and turn amplifier on and off. If noise is eliminated, connect REM lead of amplifier to source unit with a delay turn-on module.
	Voltage spike from remote turn-on lead is entering through REM input terminal.	Use different 12 volt source for REM lead of amplifier (i.e., battery direct). If noise is eliminated, use relay to isolate amplifier from noise turn-on output.
No output from Pass-Thru output of amplifier.	RCA Input from source unit is not connected or not functioning properly.	Check connections, substitute with known working source and cables and repair or replace as necessary.
	When using the BLT, Balanced Line Input from BLT is not connected or not functioning properly.	Check connections, substitute with known working BLT and cables and repair or replace as necessary.
	Unbalanced/Balanced Line switch is not selected for corresponding input.	Check switch position and correct as necessary.
	RCA cables or amplifier connected to Pass-Thru output is defective.	Check connections, substitute with known working cables or amplifier and repair or replace as necessary.

- If noise persists, see your local Authorized Rockford Fosgate Dealer.

AUTOSOUND 2000's

QUICK CHECK FOR TROUBLESHOOTING CAR AUDIO SYSTEMS

Preface:

All audio systems exhibit noise; however, if the level of noise is low enough, and the signal level high enough, noise should not be a problem. This means that it is very important that the signal level throughout the system be optimized **BEFORE** dealing with your noise problem. Using a scope (or a small portable amplifier) and Track 99 (1kHz at all high bits) of Rockford Fosgate CD RF-CD101 (Autosound 2000's CD #101) or Tracks 24 through 29 of Rockford Fosgate CD RF-CD102 (Autosound 2000's CD #102), adjust the system so that when the maximum usable signal level of the deck is fed into the system, all the preamp level components clip at the same time. However, we recommend up to as much as a 3:1 voltage overlap with the power amplifiers; i.e. an amplifier with a 2 volt minimum sensitivity can be driven by up to 6 volts of signal.

Noise Overview:

Car audio electrical accessories are notorious for interfering with car audio systems. The interference commonly arises from three areas:

- 1) Power line noise (5%), which can be attenuated with in-line noise filters,
- 2) Inadequate power supply isolation (45%), which can be cured with transformer signal coupling, additional isolated power supplies, or changing out components, or
- 3) Inductive interference (45%) – including loop area inductive noise picked up by the signal cables – which can be remedied by relocating or rewiring components, rerouting signal cables, or using twisted cable or balanced transmission systems.

Autosound 2000 1-2-3 Method of Logical Troubleshooting

- I. **MUTE THE AMP(S).** Insert a muting plug (shorted male RCA connector) into each amplifier channel. Turn up the amp sensitivity. Start the car and turn on the headlights, air conditioning, brake lights, etc. Listen for noise in each speaker. Be very picky here!
 - A. If still noisy, substitute a small test speaker with short leads for the speakers, crossovers, and speaker leads in the car. If still noisy, substitute an isolated power supply (120 VAC to 13.8 VDC bench supply or a small motorcycle battery) for the car's alternator. If the amplifier is noisy with the test speaker, you have a BAD amp. Send it in. It really doesn't matter if it is quiet or noisy while running on the isolated supply because you have a BAD amp. Send it in for repair and if it was quiet on the isolated supply, indicate so on the repair tag.
 - B. If your muted amp is quiet, you've just joined 99.5% of car audio. Amps are usually very clean and do NOT pick up unwanted noise! Continue on to Step II.
- II. **DECK TO AMP.** Using a new set of signal cables, connect one channel from the output of the deck directly into one channel of your clean amp. Run the cables outside the car and as far away as possible from the metal of the car. (For noise purposes, consider a 2" thick cushion of electromagnetic energy emanating from every metal surface in the car.)
 - A. If still noisy, congratulations, in all probability your equalizer, electronic crossover, DSP, whatchamacallit, are just fine. This means that you can't get your deck playing quiet with your amp, right? Go to Step III.
 - B. If all is quiet, congratulations, in all probability your deck and amplifier(s) are fine – you obviously have a problem with your equalizer, electronic crossover, DSP, etc. Skip on down to "Time for the Processors."

- III. **MOVE THE DECK.** If you're at this step, it's time to turn your system into an "amplified deck" by temporarily relocating the deck right ON TOP of the clean amplifier. Then using very, very short signal cables, connect the output of the deck into the input of the amp and test for noise. Play a zero bit track – silence – and make sure all is completely quiet.
- A. If still noisy, you're in a heap of trouble. We suggest that you try another deck and give us a call so that we can put your name into the record books. It's a bad car audio day for you.
 - B. If the deck is quiet, then congratulations, you're on your way to a successful installation. It is now time to slowly, methodically, reinstall the deck back into its final position. Test for noise each step of the way. If the noise returns, suspect the signal cables. Forget shielding because it will have only a very, minimal effect within the audio band. We highly suggest using twisted pair cables or a balanced transmission system for cable induced noise.

Time for Processors:

By the end of Step III, you should have the deck playing quietly with the amp, with the quiet cables quietly routed. So it's time to add the signal processors – one at a time – back into the system. Simply repeat Steps II and III with the equalizer, then the electronic crossover, etc. However, before **MOVING THE SIGNAL PROCESSORS** to the amplifier, we highly suggest that you power the noisy process from an isolated power supply rather than the car's +12 volts DC and chassis ground. Make sure to also connect the turn-on lead to the isolated power supply. If the processor is now quiet, then it is highly probable that the component has inadequate isolation. Solutions include changing components or permanently adding an external isolated power supply (Call Autosound 2000 at 209-465-3450 for info on isolated power supplies).

Summation:

During the design stage of your vehicles, try to avoid using extra batteries and high output alternators. Extra batteries are nothing but loads as soon as the engine is started and high output alternators usually make more noise than stock alternators. Also, extra batteries installed in the trunk of a car will **ALWAYS** force extra ripple current to flow over the car.

Install Stiffening Capacitors® as close to the power supply input of your amplifier as possible. The big caps will feed the switching power supplies of your amps and minimize the inductive losses in your power wiring. Plus, they will help your peak system response.

In problem cases, we highly recommend the use of twisted pair cable rather than coaxial cable for RCA leads. This practice will greatly minimize cable induced noise – especially in four channel amps!

Don't forget that your system is only as good as its worst component. Do **NOT** use components with inadequate power supply isolation or you will be asking for problems.

The best electrical ground on a car is the CHASSIS of the car. Do **NOT** run ground leads up to the case of the alternator or the negative battery post. Keep ALL ground leads as short as possible.

With properly isolated components, it does **NOT** matter where the component is grounded. We're sorry to say that with inadequately isolated components, it matters! With poorly isolated components, different grounds can cause different noises.

The deck is the signal reference ground for the entire sound system. The deck usually has THREE connections to the car's chassis: The black ground lead, the base of the antenna, and the metal-to-metal bond between the case of the deck and the chassis of the car. With three grounds, there is usually NO cause to worry about the ground of a deck.

Amplifiers are usually designed with adequate power supply isolation. This means that it should not matter where a deck is grounded. (Decks are grounded three times and amps float. This is car audio!)

The more components installed on a signal path, the more chances for noise to enter a system. The more electrical accessories on a car, the more noise will be produced by the alternator.

This information was compiled from more than 20 years of working in car audio. If you would like more information on this topic, or any other technical aspects of car audio, please call 800-548-8200 and ask for a subscription to Autosound 2000 Tech Briefs — the monthly magazine for the technically inclined.

DYNAMIC POWER MEASUREMENTS

About the Dynamic Power Measurements

The Audio Graph PowerCube is a test instrument used to measure the output of an amplifier in accordance with IHF-202 industry standards. The IHF-202 standard is a dynamic power measurement and was developed as a means of measuring power in a manner that best represents the Real World operation of an amplifier. Many manufacturers, including Rockford Fosgate, at times will measure amplifier power into a fixed resistor (4 ohm, 2 ohm). While this method is useful in some types of evaluation and testing, it is not representative of an amplifier that is connected to a speaker and playing music.

Music

Music is dynamic; the sound waves are complex and constantly changing. In order to simulate this, the IHF-202 standard calls for the input signal to the amplifier to be a 1kHz burst tone. This signal is input (on for 20 milliseconds) and reduced 20dB for 480 milliseconds. The signal is gradually increased in level until the amplifier's output exceeds 1% Total Harmonic Distortion (THD). At 1% distortion becomes audible, therefore, any power produced above that level is considered *unusable*. Many manufacturers represent their amplifiers' output power in excess of 10% distortion. They use many names for this measurement, such as Total Maximum Power or Maximum Output Power. This is not indicative of the *actual usable output power*.

Listening to Loudspeakers - Not Resistors

A loudspeaker is not a resistor. A resistor's value (resistance measured in ohms) is fixed. A loudspeaker's impedance is dynamic. It is constantly changing in value, dependent upon the frequency of the input signal. Therefore, measuring power with the amplifier loaded into a 4 ohm resistor is not the same as measuring power with the amplifier connected to a 4 ohm speaker. Most people do not listen to music through a resistor.

A 4 ohm speaker may experience a drop in impedance 4-6 times lower than its nominal (printed) impedance. A speaker will also create phase shifts in the signal that is passed through it. These phase shifts happen because a speaker is an inductor (voice coil) and a capacitor (compliance of the surround/spider), as well as a resistor (voice coil wire).

To simulate a speaker the Audio Graph PowerCube measures output power into 20 different loads. It tests at 8 ohms, 4 ohms, 2 ohms and 1 ohm. Each of these impedances is also tested at -60° , -30° , 0° , $+30^\circ$ and $+60^\circ$ phase angles. These different impedances and phase angles represent the shifts in impedance and phase that can occur in a typical loudspeaker.

Information Cubed

The data acquired in the testing procedure is then graphed in the form of a 3-dimensional cube, hence the name **PowerCube**.

The *Phase Angle* is expressed on the horizontal axis, the *Output Voltage* is presented on the vertical axis and the *Impedance* is displayed on the Z axis. *Output Power*, in watts, is listed on the left hand side for each impedance at each phase angle.

What is an Amplifier?

An amplifier by definition is a voltage generating device, recreating the signal which is input to it identically but with increased volume. It will be connected to a reactive load (the speaker). The impedance of this load and phase of the signal passing through the load will vary, dependent upon the frequency of the input signal (music).

Therefore, a perfect amplifier will be able to maintain the same output voltage regardless of load characteristics and will not alter the signal it is reproducing. A perfect amplifier when measured by the Audio Graph PowerCube would present data that forms a perfect cube. Unfortunately, amplifiers are not perfect. The laws of physics generally prevent it. A great amplifier is about the best one can hope to attain.

As you can see by the PowerCube and as you will experience by listening, your Punch amplifier is a GREAT AMPLIFIER!

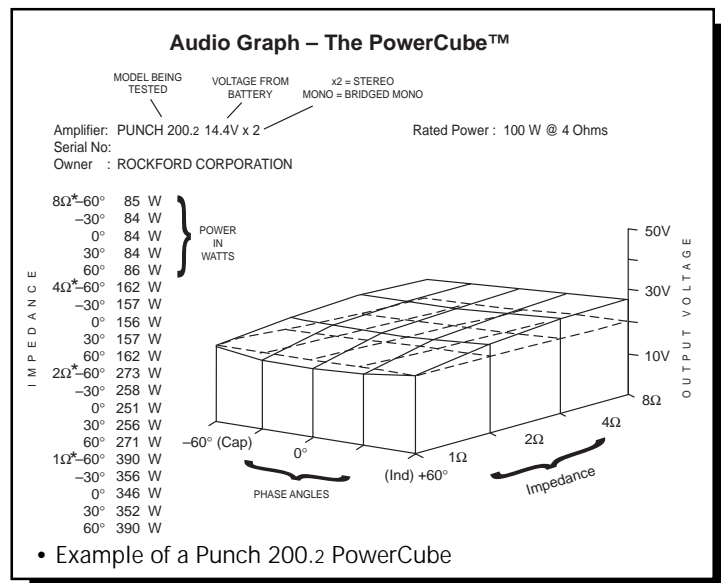

500.2 SPECIFICATIONS

Dynamic Power Rating (IHF-202 Standard) - Measured at 14.4V	
Per channel into a 4Ω load	450 Watts
Per channel into a 2Ω load	730 Watts
Bridged into a 4Ω load	1460 Watts*
Continuous Power Rating (Competition Standard) - Measured at 13.8 Battery Volts	
RMS continuous power per channel , both channels driven into a 4Ω load from 20 to 20,000Hz with less than 0.05% THD (Total Harmonic Distortion)	250 Watts
RMS continuous power per channel , both channels driven into a 2Ω load from 20-20,000Hz, with less than 0.10% THD	500 Watts
RMS continuous power mono , into 4Ω load from 20-20,000Hz, with less than 0.10% THD	1000 Watts
Common Mode Rejection Ratio (CMRR):	Typically 40dB
Signal-to-Noise Ratio:	>100dB (A-weighted)
Frequency Response:	20Hz-20,000Hz ±0.5dB
Bandwidth:	10Hz–250kHz ±3dB
Damping Factor @ 4Ω (at output connector):	>200
Slew Rate:	50V μs
IM Distortion (IHF):	<0.05%
Input Impedance:	20k Ohms
Source Unit Compatibility (+15dB gain overlap):	34V max.
Input Sensitivity (+0dB gain overlap):	Variable from 350mV to 6V
Pass-Thru Output:	Unity Gain
B+ Fuse Size: (External to amplifier)	100 Amp or two 50 Amp
Fuse Type:	(1) ANL / (2) AGU
Crossover Slope:	12dB or 24dB/octave Butterworth
Factory Crossover Frequency:	80Hz (0.047μf)
Factory Default Crossover Setting:	Full Range
Dimensions: (including end caps)	9-5/8"W x 18-9/32"L x 2-5/8"H (24.4cm) x (46.43cm) x (6.6cm)

*This is the calculated Dynamic Power Rating. Actual output power exceeded the input capability of the PowerCube.

Specifications subject to change without notice.

LIMITED WARRANTY INFORMATION

Rockford Corporation offers a limited warranty on Rockford Fosgate products on the following terms:

- **Length of Warranty**
 - 3 years on electronics
 - 2 years on source units
 - 90 days on electronic B-stock (receipt required)
 - 30 days on speaker B-stock (receipt required)
- **What is Covered**

This warranty applies only to Rockford Fosgate products sold to consumers by Authorized Rockford Fosgate Dealers in the United States of America or its possessions. Product purchased by consumers from an Authorized Rockford Fosgate Dealer in another country are covered only by that country's Distributor and not by Rockford Corporation.
- **Who is Covered**

This warranty covers only the original purchaser of Rockford product purchased from an Authorized Rockford Fosgate Dealer in the United States. In order to receive service, the purchaser must provide Rockford with a copy of the receipt stating the customer name, dealer name, product purchased and date of purchase.
- **Products found to be defective during the warranty period will be repaired or replaced (with a product deemed to be equivalent) at Rockford's discretion.**
- **What is Not Covered**
 1. Damage caused by accident, abuse, improper operations, water, theft
 2. Any cost or expense related to the removal or reinstallation of product
 3. Service performed by anyone other than Rockford or an Authorized Rockford Fosgate Service Center
 4. Any product which has had the serial number defaced, altered, or removed
 5. Subsequent damage to other components
 6. Any product purchased outside the U.S.
 7. Any product not purchased from an Authorized Rockford Fosgate Dealer
- **Limit on Implied Warranties**

Any implied warranties including warranties of fitness for use and merchantability are limited in duration to the period of the express warranty set forth above. Some states do not allow limitations on the length of an implied warranty, so this limitation may not apply. No person is authorized to assume for Rockford Fosgate any other liability in connection with the sale of the product.
- **How to Obtain Service**

Please call 1-800-669-9899 for Rockford Customer Service. You must obtain an RA# (Return Authorization number) to return any product to Rockford Fosgate. You are responsible for shipment of product to Rockford.

Ship to: **Electronics**
Rockford Corporation
Warranty Repair Department
2055 E. 5th Street
Tempe, AZ 85281
RA#: _____

Ship to: **Speakers**
Rockford Acoustic Design
(Receiving-speakers)
609 Myrtle N.W.
Grand Rapids, MI 49504
RA#: _____



LEA DETENIDAMENTE LAS SIGUIENTES INSTRUCCIONES DE INSTALACIÓN DEL PRODUCTO. EVITARA POSIBLES DAÑOS A VD., AL VEHÍCULO O AL PRODUCTO.

INTRODUCCIÓN

Los amplificadores de Punch Power representan lo ultimo y mejor que Rockford Fosgate puede ofrecerle. Muchas soluciones que nuestros ingenieros han inventado serian consideradas absolutamente desproporcionadas por nuestra competencia. **NO EN ROCKFORD FOSGATE!** Trans•nova, DIAMOND y TOPAZ diseños exclusivos de Rockford Fosgate, son solo algunas de las mas sobresalientes innovaciones que describimos con mas detalle en el capitulo de Caracteristicas Técnicas de Diseño en este mismo manual.

UBICACIÓN DE LOS AMPLIFICADORES

Maletero

Monte el amplificador vertical con las alas de refrigeración de arriba a abajo. Es el método correcto para asegurarse la máxima disipación de calor.

Habitáculo

El amplificador montado en el habitáculo funcionara bien en la medida en que se le proporcione ventilación suficiente para refrigerarse. Si piensa en montarlo debajo de un asiento deberá dejar como minimo un espacio de 3cm alrededor del refrigerador.

Instalación

- Por seguridad desconecte el cable de masa de la bateria antes de empezar la instalación.

Terminal B+

El cable de alimentación deberá tener un fusible como máximo a 30cm de la bateria. Prepare los terminales del cable e instale el portafusibles en el vano motor (si la bateria estuviera allí ubicada). Recuerde que toda la instalación debe ser impermeable.

Terminal GND (Masa o negativo)

Prepare un trozo de cable para usarlo como toma de masa. Prepare el chasis rascando toda la pintura y suciedad que pudiera haber hasta dejar la chapa viva. Conecte el chasis a masa con un tornillo.

Terminal REM (Remoto)

Conecte el terminal REM a un punto de 12V con interruptor. Normalmente se usa la salida Remote o de alimentación de antena del Radio Cassette. Si el Radio Cassette no la tuviera o no estuviera disponible se recomienda tomar de la caja de fusibles 12V y colocar un interruptor para asi activar el amplificador.

Operación mono/estéreo

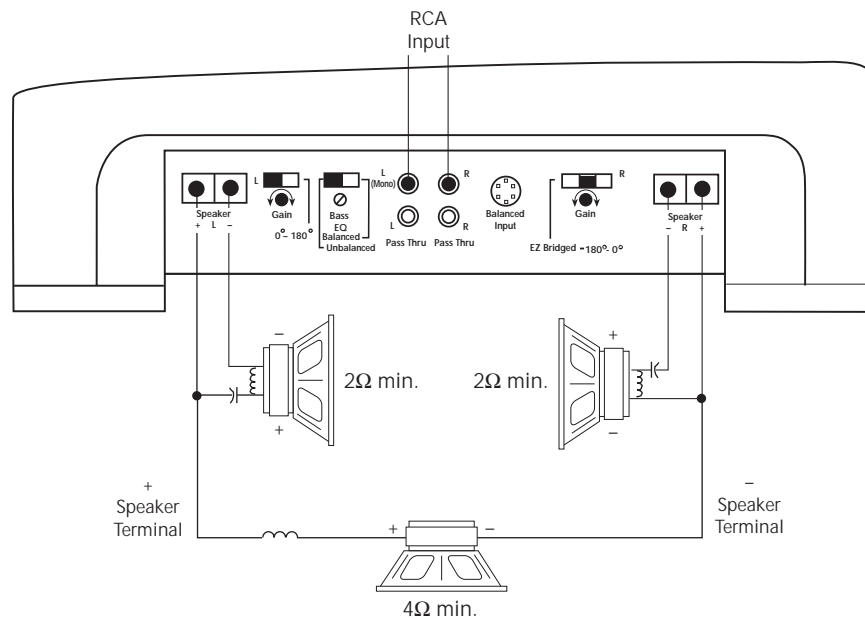

- Los conectores de entrada RCA se conectan a ambos *canales derecho e izquierdo*
- El conmutador de señal de entrada se colocara en *Unbalanced* para las entradas RCA
- El conmutador de fase del canal izquierdo estará en *0 grados*
- El conmutador de fase del canal derecho estará en *180 grados* cuando se requiera operación mono/estéreo
- La **ganancia** de los dos canales derecho e izquierdo deberán ser *exactamente iguales* para balancear correctamente el subgrave
- La **impedancia** minima para *cada canal* es de $2\ \Omega$
- La **impedancia** minima cuando se trabaje en puente será de $4\ \Omega$
- Deberá seleccionarse una XCard (tarjeta del divisor de frecuencias) de banda completa
- **Passive crossovers** are needed for proper stereo/mono operation

ATTENTION: Veuillez lire les instructions suivants pour l'installation de ce produit. Ne pas les suivre pourrait causer des blessures ou endommager le véhicule.

INTRODUCTION

La série d'amplificateurs Punch Power est la vitrine technologique de Rockford Fosgate. Nos ingénieurs utilisent ici des technologies considérées hors d'atteinte par d'autres fabricants. Trans•nova, DIAMOND et TOPAZ, exclusivement conçues par Rockford Fosgate, ne sont qu'une partie des technologies spécifiques décrites dans la section "Technical Design Features" de ce manuel.

MONTAGE

Montage dans le coffre

Monter l'amplificateur verticalement avec les rainures de haut en bas ce qui lui permet de refroidir plus facilement.

Montage dans l'habitacle

Monter l'amplificateur dans l'habitacle ne pose aucun problème, du moment qu'il y ait assez d'air pour le refroidir. Si vous montez l'ampli en dessous de siège, prévoyez 3cm d'air autour du radiateur.

Installation

Pour votre sécurité, déconnectez la borne négative de la batterie du véhicule avant de commencer l'installation.

Terminal B+

Il est impératif qu'il y ait un fusible sur le câble d'alimentation positif le plus près possible de la borne (maximum 30cm). Préparez les extrémités du câble et installez le porte fusible sous le capot. Les connexions doivent être étanches.

Terminal GND

Préparez une longueur de câble pour la connexion à la masse. Préparez le châssis en grattant la peinture de la surface métallique et nettoyez la saleté et l'huile. Attachez le câble au châssis avec une vis.

Terminal REM

Connectez le fill REM à une commande 12 volts positive de la source. La commande 12 volts est habituellement prise sur la sortie antenne électrique de la source ou la commande accessoire. Si la source ne dispose pas de ces sorties, nous vous recommandons d'installer un interrupteur qui fournira un positif 12 volts au REM de l'amplificateur.

Opération stéréo/mono (Tri-mode)

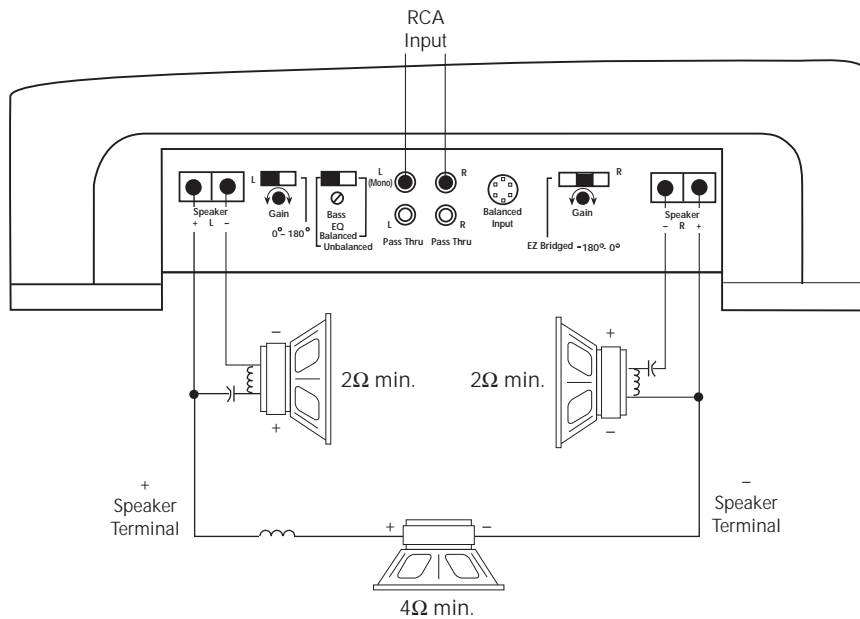

- Les entrées **RCA** sont connectées aux canaux gauche et droit
- L'interrupteur "**Signal Input**" doit se trouver dans la position "**Unbalanced**" pour utiliser l'entrée RCA
- L'interrupteur "**Left Phase**" doit se trouver dans la position "**0°**"
- L'interrupteur "**Right Phase**" doit se trouver dans la position "**180°**" pour opération en tri-mode
- Les gains des canaux gauche et droit sont réglés de la même manière pour équilibrer le subwoofer
- L'impédance de chaque canal devrait être de *minimum 2Ω*
- L'impédance du canal mono devrait être de *minimum 4Ω*
- Les **XCards** sont introduites sur *fall range*
- Il est conseillé d'utiliser les filtre passifs lorsqu'on fait fonctionner l'amplificateur en tri-mode
- **NE connecter AUCUN** des câbles HP à la masse au risque d'un fonctionnement instable.
- Les **filtres passifs** sont nécessaires pour une utilisation correcte stereo/mono

Bitte lesen Sie diese Gebrauchsanleitung zuerst sorgfältig durch. Das kann Sie vor dem falschen Einsatz, Ausfallen oder sogar Beschädigung des Produktes oder Ihres Fahrzeuges schützen.

EINLEITUNG

Die Punch Power Verstärker repräsentiert das Beste, was Rockford Fosgate anzubiete hat! Unsere Ingenieure haben in diesen Verstärkern technische Features realisiert, die in der gesamten Auto HiFi-Industrie, einzigartig sind. Trans•nova, DIABLO und TOPAZ exklusiv entwickelt von Rockford. Nähere Informationen hierüber und weitere Beschreibungen finden sie in dieser Gebrauchsanweisung unter Technical Design Features.

EINBAUORT

Im Fahrzeugkofferraum

Der vertikale Einbau der Endstufen, das bedeutet, daß die Kühlrippen von oben nach unten verlaufen, gibt dem Verstärker die beste Kühlung.

Auf der Beifahrerseite

Sollte der Verstärker auf der Beifahrerseite montiert werden, so ist es sehr wichtig, für eine ausreichende Kühlung zu sorgen. Sollte der Verstärker z.B. unter dem Beifahrersitz montiert werden, sollte dem Kühlkörper mindestens ein Luftspalt von 3cm bleiben, um so für eine ausreichende Kühlung zu sorgen.

Einbau

Zur Sicherheit klemmen Sie den Negativ-Pol der Batterie während des gesamten Einbaues ab.

B+ Anschluss

Die Plus-Leitung muß ca. 40cm nach dem Plus-Pol der Batterie abgesichert sein. Preparieren Sie die Kabellängen und montieren Sie den Sicherungshalter im Motorraum. ALLE Verbindungen müssen wasserdicht sein.

GND Anschluss

Preparieren Sie Ihr Kabel für die Negativ Leitung (Erdung). Preparieren Sie die Anschlußstelle des Erdungskabels, indem Sie das Metall gründlich reinigen und vom Lack befreien. Befestigen Sie nun die Erdung an dieser Stelle mit einer Schraube.

REM Anschluss

Verbinden Sie das Ein- und Ausschaltkontroll-Kabel mit Ihrem Radio (12 Volt positiv). Normalerweise verwenden Sie hierfür die Ant.-Remote Ihres Radios oder ein eigens dafür vorgesehenes Kabel (Amp-Remote). Sollte Ihr Radio diesen Anschluß nicht besitzen, so verwenden Sie ein 12 Volt Spannung, die Sie durch eine Schalter ein - und ausschalten können.

DEUTSCH

Stereo/Mono Betrieb

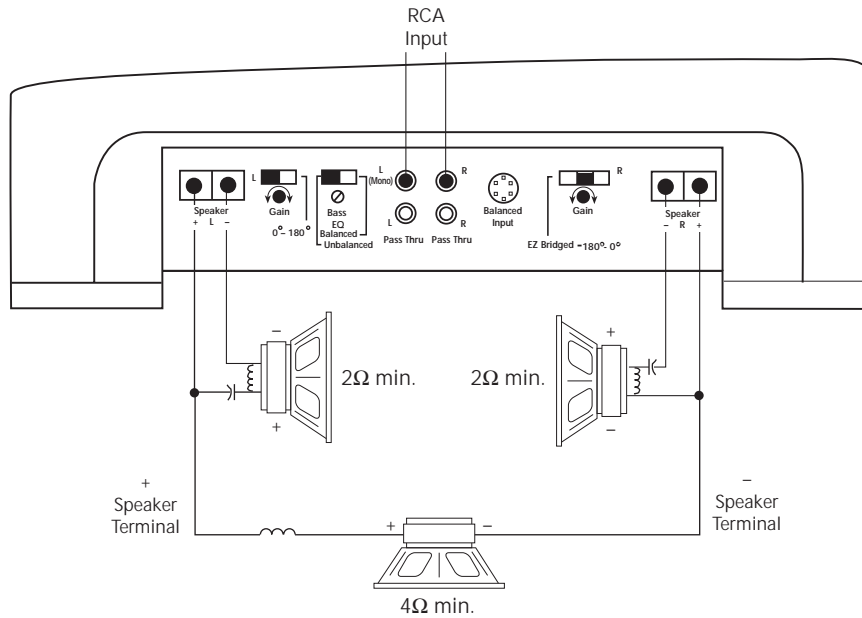

- Chinch Eingänge des rechten und linken Kanales anschließen
- **Signal Eingangsschalter** auf "unbalanced" für den Betrieb mit Chinch-Kabel stellen
- **Linken Phasen Schalter** auf 0° stellen
- **Rechten Phasen Schalter** auf 180° stellen für den Stereo/Mono Betrieb
- Die Lautsprecher-Phase des rechten Kanales umkehren, um eine Phasenkorrektur zu erreichen
- **Gain Regler** des linken Kanales angleichen, um die Lautstärke des Subwoofers einzustellen
- **Impedanz** für jeden Kanal sollte minimum *2 Ohm* betragen
- **Impedanz** im Brückenbetrieb sollte minimum *4 Ohm* betragen
- XCard sollte auf Full Range gesteckt werden
- **Passive Frequenzweichen** werden für korrekte Stereo/Mono Operationen benötigt

PREGO LEGGERE LE SEGUENTI ISTRUZIONI PER L'INSTALLAZIONE DI QUESTO PRODOTTO, IL NON SEGUIRLE POTREBBE RISULTARE SERIAMENTE DANNOSO PER LA PERSONA O PER IL VEICOLO.

INTRODUZIONE

La serie Punch Power rappresenta il massimo che Rockford Fosgate ha da offrire! I nostri ingegneri hanno sviluppato delle innovazioni tecnologiche che per altri costruttori sono considerate fantascienza, ma non per Rockford Fosgate! *Trans•nova*, *DIAMOND* e *TOPAZ*, esclusivamente progettati da Rockford, sono solo alcune delle innovazioni descritte nella sezione specifica del manuale.

DOVE POSIZIONARLO

Nel Bagagliaio

Montando l'amplificatore su una superficie in verticale con le alette direzionate dall'alto verso il basso si garantirà un miglior raffreddamento dell'amplificatore.

Nell'abitacolo

Montare l'amplificatore nell'abitacolo si avrà un funzionamento regolare se si garantisce un flusso d'aria sufficiente. Per l'installazione sotto un sedile, è necessario avere uno spazio di almeno 3 cm attorno a tutto l'amplificatore.

Installazione

Per sicurezza, scollegare il polo negativo della batteria dell'auto prima di iniziare l'installazione.

Terminale B+ (cavo positivo)

Il cavo positivo deve essere protetto da un fusibile a non più di 45 cm dalla batteria. Terminare il cavo e installare il fusibile nel vano motore. Tutte le connessioni devono essere a prova d'acqua.

Terminale GND (cavo negativo)

Decidere la lunghezza del cavo e terminarlo. Preparare la massa grattando la vernice dal telaio dell'auto ed eliminando tracce di olio o sporco. Fissare il cavo di massa al telaio con una vite.

Terminale REM (Consenso di accensione)

Collegare il cavo REM ad un positivo presente solo ad autoradio accesa (normalmente il cavo pilota dell'antenna elettrica o il cavo accessori dell'autoradio). Se la sorgente non dovesse essere equipaggiata con queste uscite, la soluzione raccomandabile è di inserire un interruttore su un cavo positivo e connettersi all'amplificatore.

Stereo/Mono Operation

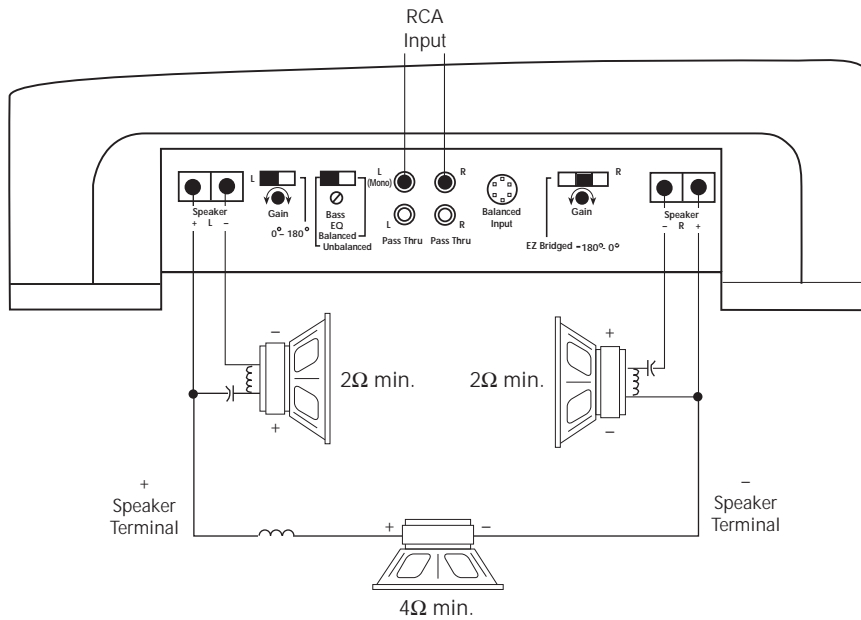

- **RCA inputs** non sono collegati ad entrambi, i canali destro e sinistro
- **Interruttore di segnale input** selezionato per il non bilanciamento per l'input RCA
- **Fase sinistra dell'interruttore** posizionata su 0° .
- **Fase destra dell'interruttore** posizionata su 180° per l'operazione stereo/mono
- Tutta la polarità dell'altoparlante del canale destro è invertita per correggere il segnale di fase
- **Gain** per i canali destro e sinistro posizionati ugualmente per bilanciare i subwoofer
- **Impedenza** per ogni canale deve essere *minimo* 2Ω
- **Impedenza** per i canali a ponte deve essere *minimo* 4Ω
- **XCard** è posizionata per *tutto il range*
- **Crossover passivi** sono indispensabili per un corretto funzionamento stereo/mono

MADE IN THE USA

This product is designed, developed and assembled in the USA by a dedicated group of American workers. The majority of the components used in the construction of this product are produced by American companies. However, due to the global nature of their manufacturing facilities and the loudspeaker parts industry in general, some parts may be manufactured in other countries.

Rockford Fosgate

Rockford Corporation
546 South Rockford Drive
Tempe, Arizona 85281 U.S.A.
In U.S.A., (602) 967-3565
In Europe, Fax (49) 8503-9340-14
In Japan, Fax (81) 559-79-1265

Free Manuals Download Website

<http://myh66.com>

<http://usermanuals.us>

<http://www.somanuals.com>

<http://www.4manuals.cc>

<http://www.manual-lib.com>

<http://www.404manual.com>

<http://www.luxmanual.com>

<http://aubethermostatmanual.com>

Golf course search by state

<http://golfingnear.com>

Email search by domain

<http://emailbydomain.com>

Auto manuals search

<http://auto.somanuals.com>

TV manuals search

<http://tv.somanuals.com>