

RTS Automatic Transfer Switch

400A, 120/240V, Single-phase

Model No.: KGATX0101400

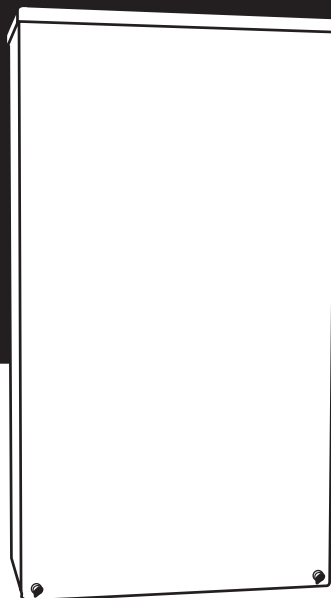

TECHNICAL MANUAL





A new standard of reliability

This manual should remain with the unit.



 **Read the following information carefully before attempting to install, operate or service this equipment. Also read the instructions and information on tags, decals, and labels that may be affixed to the transfer switch. Replace any decal or label that is no longer legible.** 

 **DANGER! Connection of a generator to an electrical system normally supplied by an electric utility shall be by means of suitable transfer equipment so as to isolate the electric system from utility distribution system when the generator is operating (Article 701 Legally Required Standby Systems or Article 702 Optional Standby Systems, as applicable). Failure to isolate electric system by these means may result in damage to generator and may result in injury or death to utility workers due to backfeed of electrical energy.** 

The manufacturer cannot anticipate every possible circumstance that might involve a hazard. The warnings in this manual, and on tags and decals affixed to the unit are, therefore, not all-inclusive. If using a procedure, work method or operating technique the manufacturer does not specifically recommend, ensure that it is safe for others. Also make sure the procedure, work method or operating technique utilized does not render the transfer switch unsafe.

Throughout this publication, and on tags and decals affixed to the generator, DANGER, WARNING, CAUTION and NOTE blocks are used to alert personnel to special instruction about a particular operation that may be hazardous if performed incorrectly or carelessly. Observe them carefully. The definitions are as follows:

 **DANGER** 

After this heading, read instructions that, if not strictly complied with, will result in personal injury or property damage.

 **WARNING** 

After this heading, read instructions that, if not strictly complied with, may result in personal injury or property damage.

 **CAUTION** 

After this heading, read instructions that, if not strictly complied with, could result in damage to equipment and/or property.

NOTE:

After this heading, read explanatory statements that require special emphasis.

These safety warnings cannot eliminate the hazards that they indicate. Common sense and strict compliance with the special instructions while performing the service are essential to preventing accidents.

Four commonly used safety symbols accompany the DANGER, WARNING and CAUTION blocks. The type of information each indicates follows:

 This symbol points out important safety information that, if not followed, could endanger personal safety and/or property of others.

 This symbol points out potential explosion hazard.

 This symbol points out potential fire hazard.

 This symbol points out potential electrical shock hazard.

GENERAL HAZARDS

- Any AC generator that is used for backup power if a NORMAL (UTILITY) power source failure occurs, must be isolated from the NORMAL (UTILITY) power source by means of an approved transfer switch. Failure to properly isolate the NORMAL and STANDBY power sources from each other may result in injury or death to electric utility workers, due to backfeed of electrical energy.
- Improper or unauthorized installation, operation, service or repair of the equipment is extremely dangerous and may result in death, serious personal injury, or damage to equipment and/or personal property.
- Extremely high and dangerous power voltages are present inside an installed transfer switch. Any contact with high voltage terminals, contacts or wires will result in extremely hazardous, and possibly LETHAL, electric shock. DO NOT WORK ON THE TRANSFER SWITCH UNTIL ALL POWER VOLTAGE SUPPLIES TO THE SWITCH HAVE BEEN POSITIVELY TURNED OFF.
- Competent, qualified personnel should install, operate and service this equipment. Adhere strictly to local, state and national electrical and building codes. When using this equipment, comply with regulations the National Electrical Code (NEC), CSA Standard; C22.1 Canadian Electric Code and Occupational Safety and Health Administration (OSHA) have established.
- Never handle any kind of electrical device while standing in water, while barefoot, or while hands or feet are wet. DANGEROUS ELECTRICAL SHOCK MAY RESULT.

- Because jewelry conducts electricity, wearing it may cause dangerous electrical shock. Remove all jewelry (such as rings, watches, bracelets, etc.) before working on this equipment.
- If work must be done on this equipment while standing on metal or concrete, place insulative mats over a dry wood platform. Work on this equipment only while standing on such insulative mats.
- Never work on this equipment while physically or mentally fatigued.
- Keep the transfer switch enclosure door closed and bolted at all times. Only qualified personnel should be permitted access to the switch interior.
- In case of an accident caused by electric shock, immediately shut down the source of electrical power. If this is not possible, attempt to free the victim from the live conductor but **AVOID DIRECT CONTACT WITH THE VICTIM**. Use a nonconducting implement, such as a rope or board, to free the victim from the live conductor. If the victim is unconscious, apply first aid and get immediate medical help.
- When an automatic transfer switch is installed for a standby generator set, the generator engine may crank and start at any time without warning. To avoid possible injury that might be caused by such sudden start-ups, the system's automatic start circuit must be disabled before working on or around the generator or transfer switch. Turn the generator's AUTO/OFF/MANUAL switch to OFF. Turn the generator's main circuit breaker OFF. Then place a "DO NOT OPERATE" tag on the transfer switch and on the generator. Remove the Negative (Neg) or (-) battery cable.

Safety RulesInside Front Cover

Section 1 – General Information2

1.1 Introduction..... 2

1.2 Equipment Description 2

1.3 Transfer Switch Data Label 2

1.4 Transfer Switch Enclosure 2

1.5 Safe Use of Transfer Switch 2

Section 2 – Installation3

2.1 Introduction to Installation..... 3

2.2 Unpacking 3

2.3 Mounting 3

2.4 Connecting Power Source and Load Lines..... 3

 2.4.1 2-Pole Mechanism 3

2.5 Connecting Start Circuit Wires 4

2.6 Auxiliary Contacts..... 4

Section 3 – Operation.....4

3.1 Functional Tests & Adjustments 4

3.2 Manual Operation..... 5

 3.2.1 Close to Normal Source Side 5

 3.2.2 Close to Emergency Source Side 6

 3.2.3 Return to Normal Source Side 6

3.3 Voltage Checks..... 6

 3.3.1 Utility Voltage Checks 6

 3.3.2 Generator Voltage Checks..... 6

3.4 Generator Tests Under Load 7

Section 4 – Installation Diagram8

Section 5 – Electrical Data9

Section 6 – Exploded Views & Parts Lists12

Section 7 – Warranty Back Cover

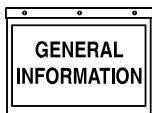

Section 1 – General Information

RTS "W" Type Transfer Switch

1.1 INTRODUCTION

This manual has been prepared especially for the purpose of familiarizing personnel with the design, application, installation, operation and servicing of the applicable equipment. Read the manual carefully and comply with all instructions. This will help to prevent accidents or damage to equipment that might otherwise be caused by carelessness, incorrect application, or improper procedures.

Every effort has been expended to make sure that the contents of this manual are both accurate and current. The manufacturer reserves the right to change, alter or otherwise improve the product at any time without prior notice.

1.2 EQUIPMENT DESCRIPTION

The automatic transfer switch is used for transferring critical electrical loads from a UTILITY (NORMAL) power source to an EMERGENCY (GENERATOR) power source.

The transfer switch prevents electrical feedback between the UTILITY and EMERGENCY sources. For that reason, electrical codes require a transfer switch in all standby electric system installations.

When the transfer switch is connected to the engine generator control panel, the control panel constantly monitors the UTILITY voltage and controls the operation of the transfer switch.

Should the UTILITY voltage drop below a preset value, and remain at this low voltage for a preset amount of time, the generator cranks and starts. After the generator starts, the transfer switch transfers the load circuits to the generator, the generator then supplies the loads. When UTILITY returns above a preset level the load is transferred back to the UTILITY and the generator shuts down.

1.3 TRANSFER SWITCH DATA LABEL

A DATA LABEL is permanently affixed to the transfer switch enclosure. Use this transfer switch only with the specific limits shown on the DATA LABEL and on other decals and labels that may be affixed to the switch. This will prevent damage to equipment and property.

When requesting information or ordering parts for this equipment, make sure to include all information from the DATA LABEL.

Record the Model and Serial numbers in the space provided below for future reference.

MODEL #
SERIAL #

1.4 TRANSFER SWITCH ENCLOSURE

The standard switch enclosure is a National Electrical Manufacturer's Association (NEMA) and UL 3R type. UL and NEMA 3R type enclosures primarily provide a degree of protection against falling rain and sleet; undamaged by the formation of ice on the enclosure.

1.5 SAFE USE OF TRANSFER SWITCH

Before installing, operating or servicing this equipment, read the SAFETY RULES (inside front cover) carefully. Comply strictly with all SAFETY RULES to prevent accidents and/or damage to the equipment. The manufacturer recommends a copy of the SAFETY RULES are made and posted near the transfer switch. Also, be sure to read all instructions and information found on tags, labels and decals affixed to the equipment.

Two publications that outline the safe use of transfer switches are the following:

- NFPA 70; National Electrical Code
- UL 1008, STANDARD FOR SAFETY-AUTOMATIC TRANSFER SWITCHES

NOTE:

It is essential to use the latest version of any standard to ensure correct and current information.



2.1 INTRODUCTION TO INSTALLATION

This equipment has been wired and tested at the factory. Installing the switch includes the following procedures:

- Mounting the enclosure.
- Connecting utility and generator power source leads.
- Connecting the load leads.
- Connecting any auxiliary contact (if needed)
- Installing/connecting any options and accessories.
- Testing functions.

2.2 UNPACKING

Carefully unpack the transfer switch. Inspect closely for any damage that might have occurred during shipment. The purchaser must file with the carrier any claims for loss or damage incurred while in transit.

Check that all packing material is completely removed from the switch prior to installation.

2.3 MOUNTING

Mounting dimensions for the transfer switch enclosure are in this manual. Enclosures are typically wall-mounted. See the “Mounting Dimensions” drawing.



- ⚠ Handle transfer switches carefully when installing. Do not drop the switch. Protect the switch against impact at all times, and against construction grit and metal chips. Never install a transfer switch that has been damaged.

Install the transfer switch as close as possible to the electrical loads that are to be connected to it. Mount the switch vertically to a rigid supporting structure. To prevent switch distortion, level all mounting points. If necessary, use washers behind mounting holes to level the unit.

2.4 CONNECTING POWER SOURCE AND LOAD LINES



- ⚠ Make sure to turn OFF both the UTILITY (Normal) and EMERGENCY (Standby generator) power supplies before trying to connect power source and load lines to the transfer switch. Supply voltages are extremely high and dangerous. Contact with such high voltage power supply lines causes extremely hazardous, possibly lethal, electrical shock.

Wiring diagrams and electrical schematics are provided in this manual. Power source and load connections are made at the transfer mechanism, inside the switch enclosure.

◆ 2.4.1 2-POLE MECHANISM

These switches (Figure 2.1) are used with a single phase system, when the single phase NEUTRAL line is to be connected to a Neutral Lug and is not to be switched.

Figure 2.1 — Typical 2-Pole Transfer Mechanism (400 Amp Shown)

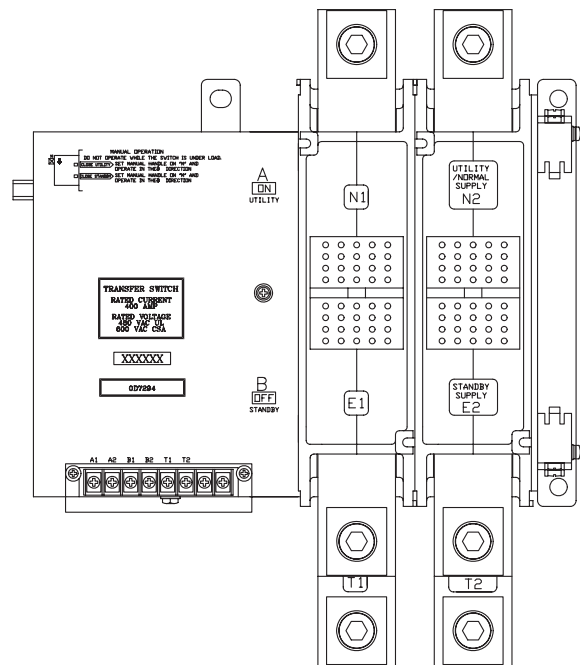

Solderless, screw-type terminal lugs are standard.

The conductor size range is as follows:

Switch Rating	Wire Range
400A	(1) #4-600 MCM or (2) 1/0-250 MCM

Conductor sizes must be adequate to handle the maximum current to which they will be subjected; based on the 75°C column of tables, charts, etc. used to size conductors. The installation must comply fully with all applicable codes, standards and regulations.

Before connecting wiring cables to terminals, remove any surface oxides from the cable ends with a wire brush. All power cables should enter the switch next to transfer mechanism terminals. If ALUMINUM conductors are used, apply corrosion inhibitor to conductors. Tighten terminal lugs to the torque values as noted on the decal located on the inside of the door. After tightening terminal lugs, carefully wipe away any excess corrosion inhibitor.

All power cables should enter the switch next to the transfer mechanism terminals.

OPERATION

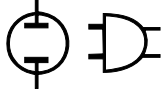

Section 3 – Operation RTS "W" Type Transfer Switch



- ⚠ Use a torque wrench to tighten the conductors, being sure not to overtighten, or damage to the switch base could occur. If undertightened, a loose connection would result, causing excess heat which could damage the switch base.

Connect power source load conductors to clearly marked transfer mechanism terminal lugs as follows

1. Connect UTILITY (NORMAL) power source cables to switch terminals N1, N2, (N3).
2. Connect EMERGENCY (STANDBY) source power cables to transfer switch terminals E1, E2, (E3).
3. Connect customer LOAD leads to switch terminals T1, T2, (T3).
4. Connect neutral conductors of UTILITY, EMERGENCY and customer LOAD to the neutral block.

Conductors must be properly supported, of approved insulative qualities, protected by approved conduit, and of the correct wire gauge size in accordance with applicable codes.

Be sure to maintain proper electrical clearance between live metal parts and grounded metal. Allow at least 1/2 inch for 100-400 amp circuits.

2.5 CONNECTING START CIRCUIT WIRES

Control system interconnections consist of UTILITY 1 and 2, and leads 23 and 194. Control system interconnection leads must be run in a conduit that is separate from the AC power lead. Recommended wire gauge sizes for this wiring depends on the length of the wire, as recommended below:

MAXIMUM WIRE LENGTH	RECOMMENDED WIRE SIZE
460 feet (140m)	No. 18 AWG.
461 to 730 feet (223m)	No. 16 AWG.
731 to 1,160 feet (354m)	No. 14 AWG.
1,161 to 1,850 feet (565m)	No. 12 AWG.

2.6 AUXILIARY CONTACTS

If desired, there are Auxiliary Contacts on the transfer switch to operate customer accessories, remote advisory lights, or remote annunciator devices. A suitable power source must be connected to the COMMON (C) terminal. See Figure 2.3.

Contact operation is shown in the following chart:

	Switch Position	
	Utility	Standby
Common to Normally Open	Open	Closed
Common to Normally Closed	Closed	Open

NOTE:

Auxiliary Contacts are rated 10 amps at 125 or 250 volts AC. DO NOT EXCEED THE RATED VOLTAGE AND CURRENT OF THE CONTACTS.

Figure 2.3 – Auxiliary Contacts

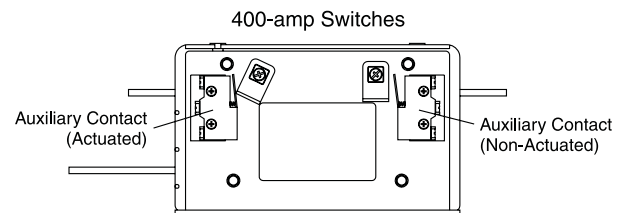

Side views shown in Utility position

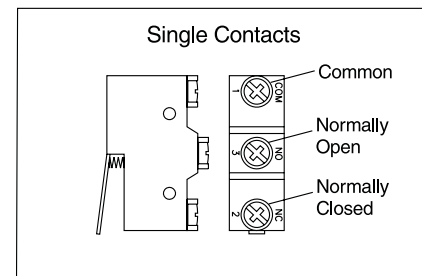

3.1 FUNCTIONAL TESTS AND ADJUSTMENTS

Following transfer switch installation and interconnection, inspect the entire installation carefully. A competent, qualified electrician should inspect it. The installation should comply strictly with all applicable codes, standards, and regulations. When absolutely certain the installation is proper and correct, complete a functional test of the system.



- ⚠ Perform functional tests in the exact order presented in this manual, or damage to the switch could be done.

IMPORTANT: Before proceeding with functional tests, read and make sure you understand all instructions and information in this section. Also read the information and instructions of labels and decals affixed to the switch. Note any options or accessories that might be installed and review their operation.

3.2 MANUAL OPERATION



⚠ Do NOT manually transfer under load. Disconnect transfer switch from all power sources by approved means, such as a main circuit breaker(s).

A manual HANDLE is shipped with the transfer switch. Manual operation must be checked BEFORE the transfer switch is operated electrically. To check manual operation, proceed as follows:

1. Turn the generator’s AUTO/OFF/MANUAL switch to OFF.
2. Turn OFF both UTILITY and EMERGENCY power supplies to the transfer switch, with whatever means provided (such as the main line circuit breakers).
3. Note position of transfer mechanism main contacts by observing display windows in “A” and “B” in Figure 3.1 on page 6 as follows:
 - Window “A” ON, Window “B” OFF - LOAD terminals (T1, T2, T3) are connected to utility terminals (N1, N2, N3).

- Window “A” OFF, Window “B” ON - LOAD terminals (T1, T2, T3) are connected to emergency terminals (E1, E2, E3).



⚠ Do not use excessive force when operating the transfer switch manually or the manual handle could be damaged.

◆ 3.2.1 CLOSE TO NORMAL SOURCE SIDE

Before proceeding, verify the position of the switch by observing window “A” in Figure 3.1. If window “A” reads “ON”, the contacts are closed in the normal position, no further action is required. If it reads “OFF”, proceed with Step 1.

Step 1: With the handle attached to the actuating shaft, move handle in the direction of the arrow on the switch cover until it stops — DO NOT FORCE. Release handle slowly to allow the spring in the switch box to relax. “ON” now appears in Window “A” and “OFF” appears in Window “B”.

Figure 3.1 — Actuating Transfer Switch



DANGER: Do NOT manually transfer under load. Disconnect transfer switch from all power sources by approved means, such as a main circuit breaker(s).

Detail of instructions printed on transfer switch

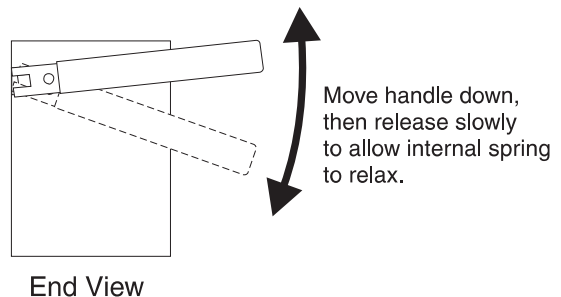
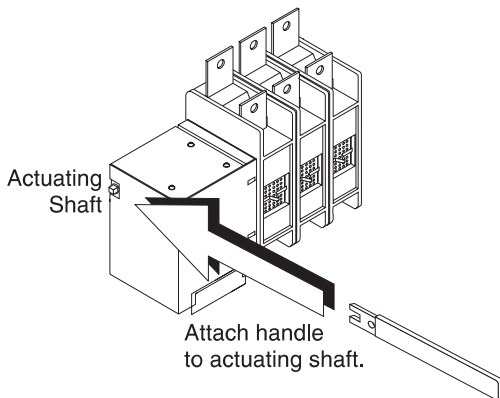
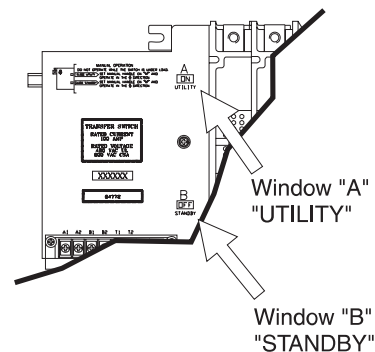
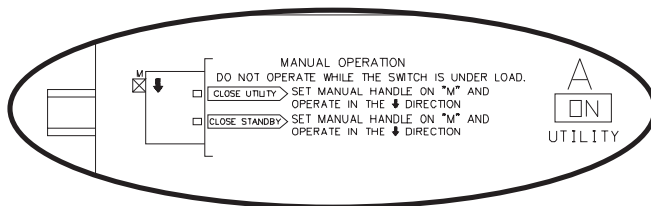

NOTE: Return handle to storage position in enclosure when finished with manual transfer

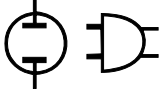

◆ **3.2.2 CLOSE TO EMERGENCY SOURCE SIDE**

Before proceeding, verify the position of the switch by observing window "B" in Figure 3.1. If window "B" reads "ON", the contacts are closed in the EMERGENCY (STANDBY) position. No further action is required. If it reads "OFF", proceed with Step 1.

Step 1: With the handle attached to the actuating shaft, move the handle in the direction of the arrow on the switch cover until it stops - DO NOT FORCE. Release handle slowly to allow the spring in the switch box to relax. "OFF" now appears in Window "A" and "ON" appears in Window "B".

◆ **3.2.3 RETURN TO NORMAL SOURCE SIDE**

Manually actuate switch to return Window "A" to the "ON" position.

3.3 VOLTAGE CHECKS

◆ **3.3.1 UTILITY VOLTAGE CHECKS**

1. Turn ON the UTILITY power supply to the transfer switch with whatever means provided (such as the UTILITY main line circuit breaker).



⚠ **PROCEED WITH CAUTION. THE TRANSFER SWITCH IS NOW ELECTRICALLY HOT. CONTACT WITH LIVE TERMINALS RESULTS IN EXTREMELY HAZARDOUS AND POSSIBLY FATAL ELECTRICAL SHOCK.**

2. With an accurate AC voltmeter, check for correct voltage.

Single-phase utility supply:

Measure across ATS terminal lugs N1 and N2; N1 to NEUTRAL and N2 to NEUTRAL.



⚠ **FAILURE TO TURN OFF THE UTILITY SUPPLY BEFORE WORKING ON THE UTILITY CONNECTIONS OF THE ATS WILL RESULT IN EXTREMELY DANGEROUS AND POSSIBLY FATAL ELECTRICAL SHOCK.**

5. When certain that UTILITY supply voltage is correct and compatible with transfer switch ratings, turn OFF the UTILITY supply to the transfer switch.

◆ **3.3.2 GENERATOR VOLTAGE CHECKS**

1. On the generator panel, set the AUTO/OFF/MANUAL switch to MANUAL position. The generator should crank and start.
2. Let the generator stabilize and warm up at no-load for at least five minutes.
3. Set the generator's main circuit breaker (CB1) to its ON or CLOSED position.



⚠ **PROCEED WITH CAUTION. GENERATOR OUTPUT VOLTAGE IS NOW BEING DELIVERED TO TRANSFER SWITCH TERMINALS. CONTACT WITH LIVE TERMINALS RESULTS IN EXTREMELY DANGEROUS AND POSSIBLY FATAL ELECTRICAL SHOCK.**

4. With an accurate AC voltmeter and frequency meter, check the no-load, voltage and frequency.

Single-phase generator supply:

Measure across ATS terminal lugs E1 to E2; E1 to NEUTRAL and E2 to NEUTRAL.

- a. Frequency 60-62 Hz
 - b. Terminals E1 to E2 240-246 VAC
 - c. Terminals E1 to NEUTRAL 120-123 VAC
 - d. Terminals E2 to NEUTRAL 120-123 VAC
5. When certain that UTILITY supply voltage is correct and compatible with transfer switch ratings, turn OFF the UTILITY supply to the transfer switch.
 6. Set the generator's main circuit breaker (CB1) to its OFF or OPEN position.
 7. Set the AUTO/OFF/MANUAL switch to the OFF position to shut down the generator.

NOTE:

Do NOT proceed until generator AC output voltage and frequency are correct and within stated limits. If the no-load voltage is correct but no-load frequency is incorrect, the engine governed speed probably requires adjustment. If no-load frequency is correct but voltage is not, the voltage regulator may require adjustment.

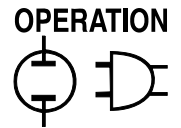

3.4 GENERATOR TESTS UNDER LOAD

1. Set the generator's main circuit breaker to its OFF or OPEN position.
2. Manually actuate the transfer switch main contacts to their EMERGENCY (STANDBY) position. Refer to “Manual Operation” section.
3. To start the generator, set the AUTO/OFF/MANUAL switch to MANUAL. When engine starts, let it stabilize for a few minutes.
4. Turn the generator's main circuit breaker to the ON or CLOSED position. The generator now powers all LOAD circuits. Check generator operation under load as follows:
 - Turn ON electrical loads to the full rated wattage/ampere capacity of the generator. DO NOT OVERLOAD.
 - With maximum rated load applied, check voltage and frequency across transfer switch terminals E1 and E2. Voltage should be greater than 200 volts (208VAC system) or 230 volts (240VAC system); frequency should be greater than 59 Hz.
 - Let the generator run under rated load for at least 30 minutes. With unit running, listen for unusual noises, vibration, overheating, etc., that might indicate a problem.
5. When checkout under load is complete, set main circuit breaker of the generator to the OFF or OPEN position.
6. Let the generator run at no-load for several minutes. Then, shut down by setting the AUTO/OFF/MANUAL switch to its OFF position.
7. Move the switch's main contacts back to the UTILITY position. For example, load connected to utility power supply. Refer to “Manual Operation”. Handle and operating lever of transfer switch should be in down position.
8. Turn on the utility power supply to transfer switch, using whatever means provided (such as a utility main line circuit breaker). The utility power source now powers the loads.
9. Set the generator's AUTO/OFF/MANUAL switch to its AUTO position. The system is now set for fully automatic operation.

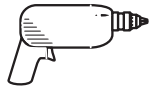

Section 4 – Installation Diagram

RTS "W" Type Transfer Switch

Installation Diagram – Drawing No. 0F6401

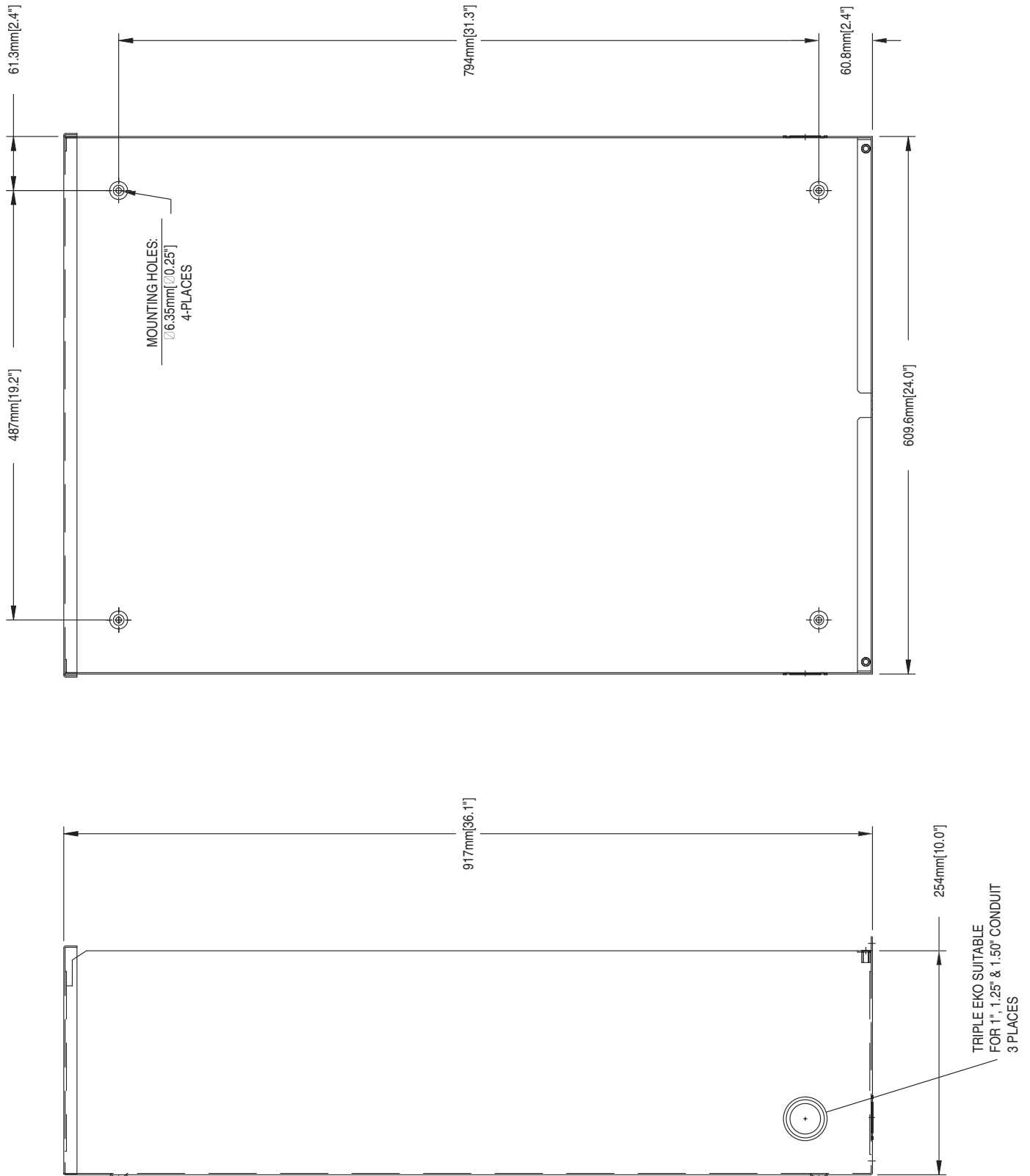

Section 5 – Electrical Data
 RTS "W" Type Transfer Switch
 Interconnection Diagram - Drawing No. 0G1944

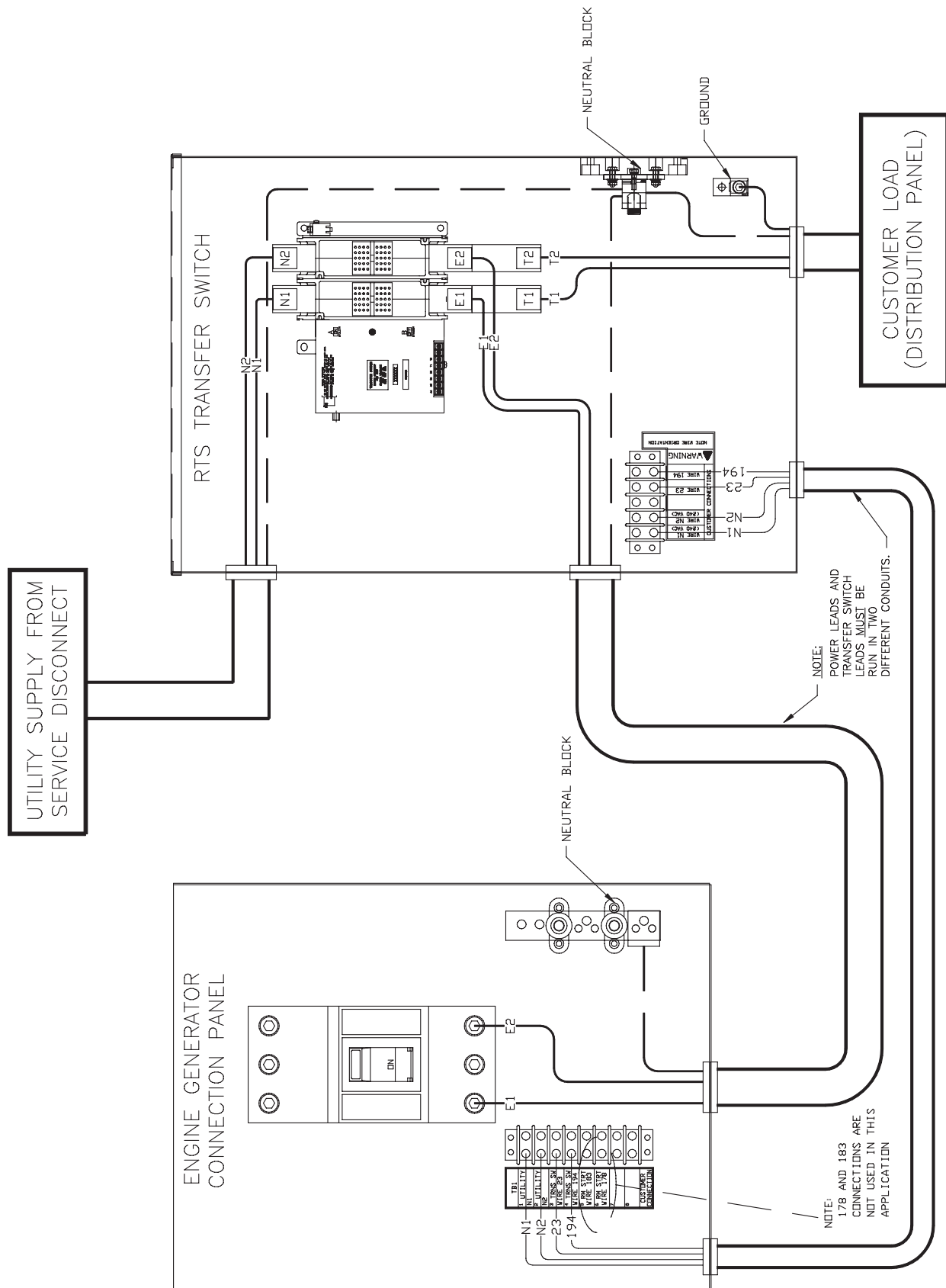
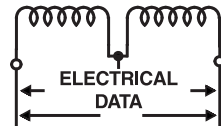

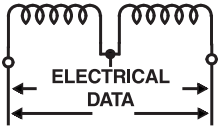

Section 5 – Electrical Data

RTS "W" Type Transfer Switch

Wiring Diagram/Schematic – Drawing No. 0D3819-A

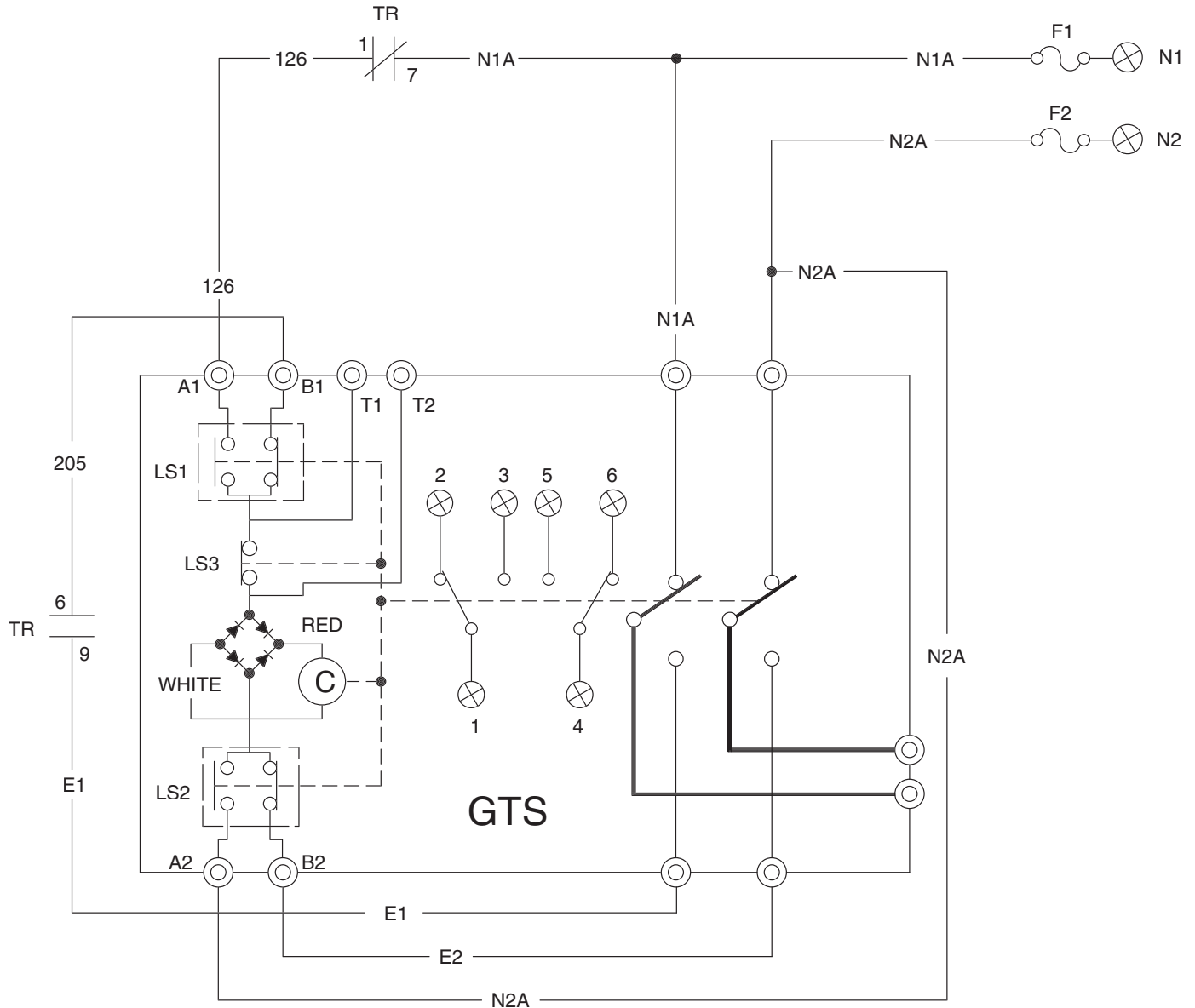

LEGEND	
C	- CONTACTOR ACTUATING COIL
GTS	- TRANSFER SWITCH CONTACTOR
TR	- RELAY, TRANSFER
TS	- TERMINAL STRIP (CUSTOMER CONNECTION)
LS1,LS2,LS3	- LIMIT SWITCHES, ACTUATOR
F1,F2	- FUSE 5A SENSING

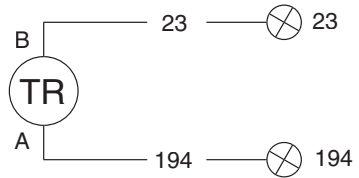

NOTES:
 ALL CONTACTS SHOWN WITH
 TRANSFER SWITCH IN UTILITY
 POSITION.

Section 5 – Electrical Data
RTS "W" Type Transfer Switch
Wiring Diagram/Schematic – Drawing No. OD3819-A

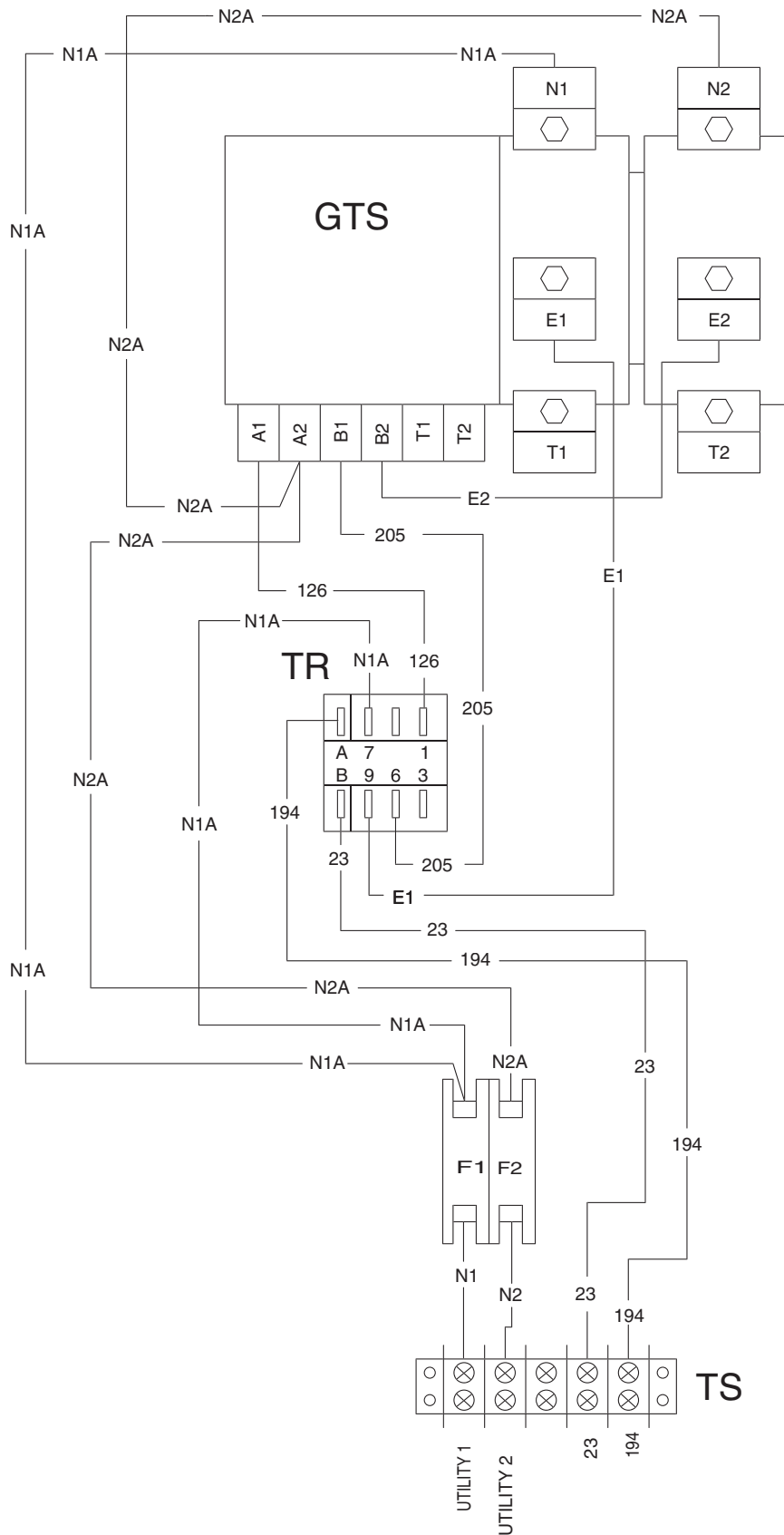
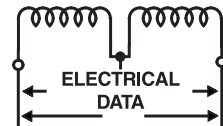

Section 6 – Exploded Views and Parts List

RTS "W" Type Transfer Switch

400 A Switch Assembly – Drawing No. 0G1510\$

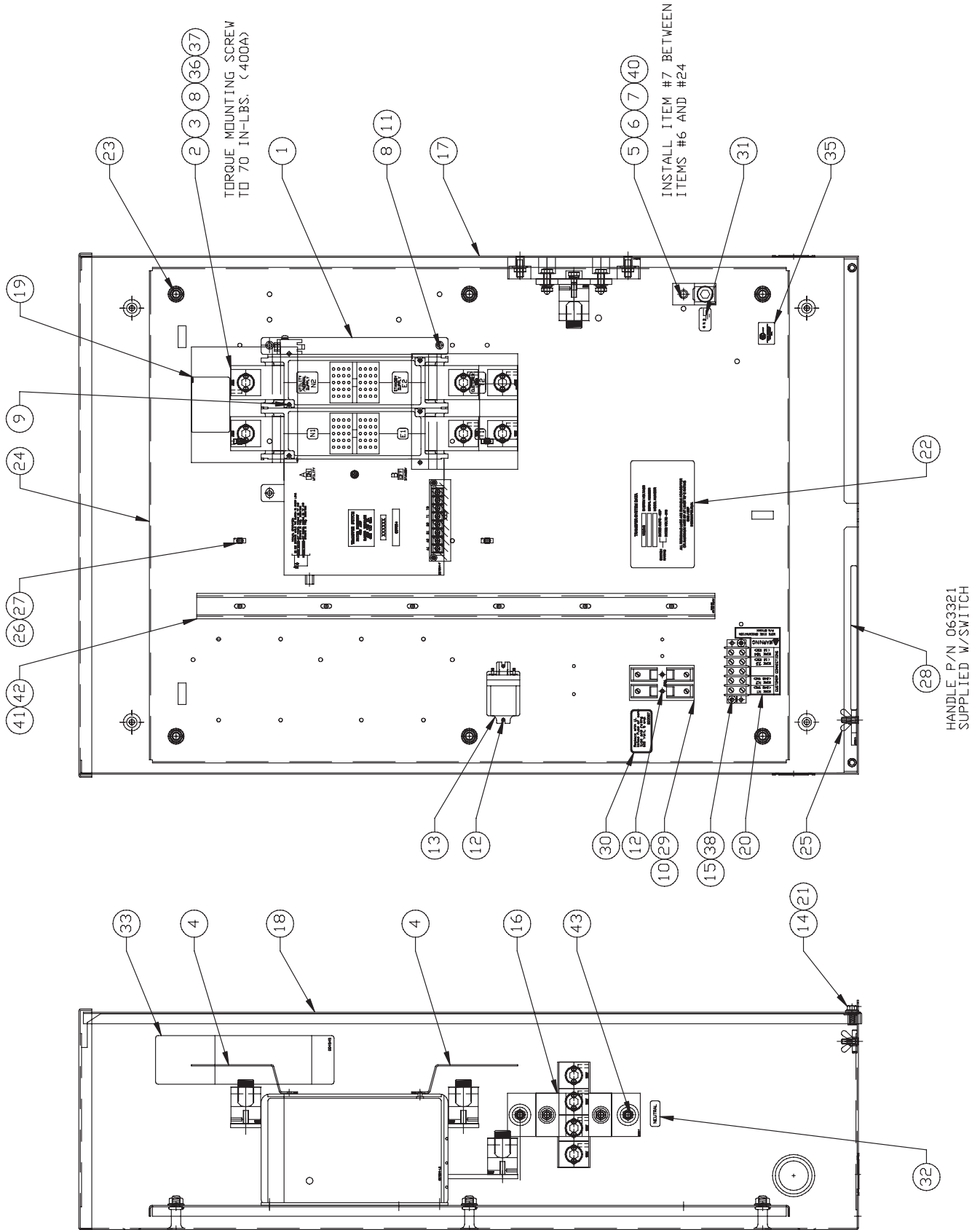

Section 6 – Exploded Views and Parts List

RTS "W" Type Transfer Switch

400 A Switch Assembly – Drawing No. 0G1510\$

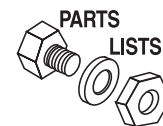

ITEM	PART NO.	QTY.	DESCRIPTION
1	0D7294	1	XFER SW-W 400A600V2P
2	0A7822	6	LUG, SLDLSS 600/250-1/0X1/4-28
3	026902	5	SCREW TAPTITE #8-32X1/4 BP
4	0C7907J	2	COVER LUG 2P 400AMP
5	024526	1	SCREW HHTT 5/16-18 X 3/4 CZ
6	057329	1	LUG, SOLDERLESS 350-#6X13/32 AL/CU
7	027482	1	WASHER SHAKEPROOF EXT 5/16 STEEL
8	022097	9	WASHER LOCK M6-1/4
9	0C8275	4	SCREW PPHM DSEMS M4-.7 X 10 ZNC
(2) 10	0D2806	1	FUSEBLOCK 30A 600V 2POS W/SQ
11	090388	3	SCREW TAPTITE M6-1.0 X 12 MM
12	0A1495	6	SCREW TAPTITE M4-.7 X 10 MM
(2) 13	063617	1	RELAY PNL 12VDC DPDT 10A@240VA
14	047411	2	SCREW HHC M6-1.0 X 16 G8.8
15	0A1661	2	RIVET, POP
16	0F4034	1	ASSY. NEUTRAL BLOCK 300/400A
17	0F5935	1	RTS 3R ENCLOSURE 24X36X10
18	0F5939	1	COVER TRANSFER SWITCH
19	0C8308	2	DECAL TERMINAL SHOCK HAZARD
20	0C2262	1	DECAL TERMINAL STRIP
21	0F6165	2	WASHER, NYLON
22	0G1520	1	DECAL,DATA XFER SW 400A,240V
23	064101	6	NUT HEX FL WHIZ 3/8-16
24	0F5940	1	SUBPLATE,100A TS 3R 480V
25	087680	1	NUT WING M6-1.0
26	063378	4	HOLDER CABLE TIE
27	064761	4	TIE WRAP UL 5.6" X .10" NATL
28	063321	1	HANDLE TRANSFER SWITCH 1-400A
29	073590A	2	FUSE 5A X BSS HLDR73591
30	0D3587	1	DECAL,FUSE REPLACEMENT
31	067210A	1	DECAL GROUND LUG
32	0A9457	1	DECAL NEUTRAL
33	0D4545	1	DECAL MANUAL OPERATION
(1) 34	0F6129	1	DECAL, TEST SEQUENCE
35	081221	1	DECAL, UL NAMEPLATE
36	0A8261	6	SCREW, HHCS 1/4-28 X 5/8"
37	022473	6	WASHER, FLAT 1/4-6M ZINC
(2) 38	048850	1	BLOCK TERM 20A 5 X 6 X 1100V
39	0F6273A	1	HARNESS 400A 2 POLE RTS (NOT SHOWN)
40	022129	1	WASHER LOCK M8-5/16
41	091472	2'	DUCT WIRING 1X1.5
42	091472A	2'	COVER WIRE DUCT 1 IN
43	067989	2	NUT HEX FL WHIZ M8-1.25

(1) CENTER DECAL ON INSIDE OF THE COVER (ITEM #18)

(2) ITEMS INCLUDED WITH HARNESS



Section 8 – Warranty

RTS "W" Type Transfer Switch

CARRIER WARRANTY/SERVICE

Carrier will warrant that from the date of purchase, our transfer switch will be free from defects in material and workmanship for the items and periods set forth in the warranty statement found in the owners manual of the Carrier generator that this transfer switch will be utilized with.

Any equipment that the purchaser/owner claims to be defective must be examined by the nearest Carrier Dealer.

THIS WARRANTY IS IN PLACE OF ALL OTHER WARRANTIES, EXPRESSED OR IMPLIED, SPECIFICALLY, CARRIER MAKES NO OTHER WARRANTIES AS TO THE MERCHANTABILITY OR FITNESS FOR A PARTICULAR PURPOSE.

Some states do not allow limitations on how long an implied warranty lasts, so the above limitation may not apply to you.

CARRIER'S ONLY LIABILITY SHALL BE THE REPAIR OR REPLACEMENT OF PART(S) AS STATED ABOVE. IN NO EVENT SHALL CARRIER BE LIABLE FOR ANY INCIDENTAL, OR CONSEQUENTIAL DAMAGES, EVEN IF SUCH DAMAGES ARE A DIRECT RESULT OF CARRIER'S NEGLIGENCE.

Some states do not allow the exclusion or limitation of incidental or consequential damages, so the above limitations may not apply to you.

This warranty gives you specific legal rights. You also may have other rights that vary from state to state.

Free Manuals Download Website

<http://myh66.com>

<http://usermanuals.us>

<http://www.somanuals.com>

<http://www.4manuals.cc>

<http://www.manual-lib.com>

<http://www.404manual.com>

<http://www.luxmanual.com>

<http://aubethermostatmanual.com>

Golf course search by state

<http://golfingnear.com>

Email search by domain

<http://emailbydomain.com>

Auto manuals search

<http://auto.somanuals.com>

TV manuals search

<http://tv.somanuals.com>