

2-CHANNEL DSM AMPLIFIERS

PUNCH 40ix / PUNCH 60ix

PUNCH 100ix / PUNCH 200ix

**INSTALLATION & OPERATION
MANUAL**



Dear Customer,

Congratulations on your purchase of the world's finest brand of car audio amplifiers. At Rockford Fosgate we are committed to musical reproduction at its best, and we are pleased you chose our product. Through years of engineering expertise, hand craftsmanship and critical testing procedures, we have created a wide range of products that reproduce music with all the clarity and richness you deserve.

For maximum performance we recommend you have your new Rockford Fosgate product installed by an Authorized Rockford Fosgate Dealer, as we provide specialized training through Rockford Technical Training Institute (RTTI). Please read your warranty and retain your receipt and original carton for possible future use.

To add the finishing touch to your new Rockford Fosgate image order your Rockford accessories, which include everything from T-shirts and jackets to hats and sunglasses.

To get a free brochure on Rockford Fosgate products and Rockford accessories, in the U.S. call 602-967-3565 or FAX 602-967-8132. For all other countries, call +001-602-967-3565 or FAX +001-602-967-8132.

PRACTICE SAFE SOUND™

CONTINUOUS EXPOSURE TO SOUND PRESSURE LEVELS OVER 100dB MAY CAUSE PERMANENT HEARING LOSS. HIGH POWERED AUTO SOUND SYSTEMS MAY PRODUCE SOUND PRESSURE LEVELS WELL OVER 130dB. USE COMMON SENSE AND PRACTICE SAFE SOUND.

If, after reading your manual, you still have questions regarding this product, we recommend that you see your Rockford Fosgate dealer. If you need further assistance, you can call us direct at 1-800-795-2385. Be sure to have your serial number, model number and date of purchase available when you call.

The serial number can be found on the outside of the box. Please record it in the space provided below as your permanent record. This will serve as verification of your factory warranty and may become useful in recovering your amplifier if it is ever stolen.

Serial Number: _____

Model Number: _____

TABLE OF CONTENTS

Introduction	1
Punch 2-Channel Amplifier Accessory Pack	1
Rockford Fosgate Accessories	2
Technical Design Features	3
Design Features	6
Installation Considerations	8
Mounting Location	9
Battery and Charging	10
Wiring the System	10
Using the XCard	13
Basic Connections	14
System Diagrams	18
Troubleshooting	22
Dynamic Power Measurements	24
Specifications	26
Warranty Information	28

GETTING STARTED

Welcome to Rockford Fosgate! This manual is designed to provide information for the owner, salesperson and installer. For those of you who want quick information on how to install this product, please turn to the Basic System Diagrams in the Installation section of this manual. Other information can be located by using the Table of Contents. We, at Rockford Fosgate, have worked very hard to make sure all the information in this manual is current. But, as we are constantly finding new ways to improve our product, this information is subject to change without notice.

INTRODUCTION

Rockford engineers designed the Punch 2-channel amplifiers to withstand the rugged automotive environment while delivering superior sound quality in a flexible, reliable, and efficient package. A grounding technique called TOPAZ was used to eliminate noise problems associated with car audio systems, while flexibility was accomplished with the use of a built-in XCard. Reliability was accomplished with the use of protection circuits called RTP and NOMAD, while MOSFET and DSM technology improve amplifier efficiency. The result of these components give the Punch amplifier awesome sound quality in a "Bullet Proof" package. An explanation of these technologies, some exclusively designed by Rockford, are described in the Technical Design Features.

PUNCH 2-CHANNEL AMPLIFIER ACCESSORY PACK

The accessory pack shipped with the Punch 2-channel amplifiers includes the mounting hardware necessary to secure them to the vehicle as well as attaching the end caps.

Installation & Operation Manual

Punch Verification Certificate

- (1) 17' (518.16cm) Red Power Wire
- (1) 12' (365.76cm) Remote Turn-On Wire
- (1) 1.5' (45.72cm) Black Grounding Wire
- (1) Female Connector for Remote Turn-On Wire
- (1) Ring Terminal for Ground Wire
- (1) Ring Terminal for Battery Post
- (1) ATC Inline Fuseholder (Punch 40ix, 60ix, 100ix)
- (1) AGU Inline Fuseholder (Punch 200ix)
- (6) Hex Head Screws for speaker and power connectors
- (4) Mounting Screws for end caps
- (4) Mounting Screws for amplifier
- (1) Allen Wrench 7/64"
- (1) Allen Wrench 3/32"

ROCKFORD FOSGATE ACCESSORIES

The following accessories were designed to enhance the performance of the Punch 2-channel amplifiers.

Energy Storage Capacitor

The Punch capacitors are used to provide extra current needed by amplifiers to reproduce musical transients. The Punch Caps also have the natural ability to filter AC ripple caused by the alternator, reducing the chance of noise in the system. The Punch Caps will maximize both the sound quality and performance that Rockford Fosgate amplifiers can deliver.

Punch Link (FG-LINK)

The Punch Link is a specially cast heatsink interconnect which allows you to join any of our current Punch or Punch Power amplifiers together. While providing additional cooling through the coupling process, the Punch Link adds the finishing touch by giving you the look of one awesome amplifier.

XCard

Additional crossover card frequencies are available for specialized requirements. You can get the following XCards from your Authorized Rockford Fosgate Dealer.

XM50 = 50Hz	XM275 = 275Hz
XM70 = 70Hz	XM400 = 400Hz
XM100 = 100Hz	XM4.5k = 4,500Hz
XM150 = 150Hz	XM6.5k = 6,500Hz
XM200 = 200Hz	XM00 = Blank card for custom crossover

TECHNICAL DESIGN FEATURES

◆ TOPAZ (Tracking Operation Pre-Amplifier Zone)

The **TOPAZ** (Tracking Operation Pre-Amplifier Zone) circuitry solves ground loop noise problems common to automotive amplifier design. This innovative new development allows vastly improved isolation of the input signal grounds from the power supply ground of the amplifier. This is accomplished by allowing the source unit to control the potential “environment” of the entire input structure or “zone” of the amplifier. This process improves the noise rejection of the amplifier by 30-40dB – an astounding 30-100 times better than amplifiers without TOPAZ.

THE RESULT: Elimination of troublesome ground loop noise between source and amplifier.

◆ RTP (Real Time Protection) NOMAD (NON-Multiplying Advanced Decision)

The Punch and Power amplifiers use an ***analog computer process*** to maximize safe output power under all operating conditions. Rockford Fosgate pioneered and developed **RTP** (Real Time Protection), a crucial element in the performance edge of our amplifiers. The innovative **NOMAD (NON-Multiplying Advanced Decision)** system is the most sophisticated version of this technique ever used, bringing previously unavailable levels of accuracy, stability, temperature immunity and reliability to this critical process. NOMAD makes advanced decisions based on device voltages to precisely control the awesome levels of current available in the output MOSFETs to safe values – but only when absolutely needed.

THE RESULT: Extremely fast protection system that always protects the amplifier and never degrades the sound.

◆ DSM (Discrete Surface Mount) Technology

The *DSM* (Discrete Surface Mount) manufacturing process combines the advantages of both discrete components and integrated circuitry. Rockford Fosgate is the only American amplifier manufacturer to have invested millions into this process. DSM components differ from conventional discrete components in three different ways. They are more compact, more rugged, and they take much better advantage of the PC board to allow them to get rid of any heat they generate. Using them wherever appropriate allows the advantages associated with discrete circuitry to be retained while also providing room for both highly advanced processing features and generous PC board copper paths where needed. Their short lead-out structures allow maximum audio performance and highest signal-to-noise ratios to be obtained in amplifiers of desirable package size without resorting to “amplifier-on-a-chip” shortcuts. These advantages are shown below in Figure 1.

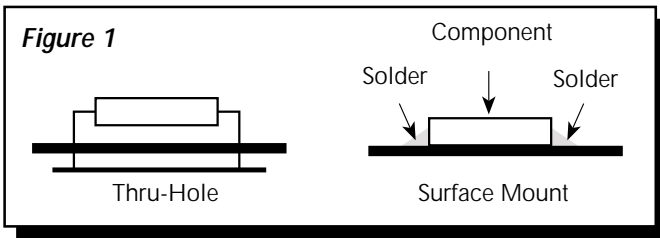

THE RESULT: Fewer connections, improved reliability, shorter signal paths, superior signal-to-noise ratio and awesome sonic performance.

◆ XCard (Internal Crossover)

The Punch and Power amplifiers utilize internal active crossovers. These crossovers have many performance advantages such as using discrete components for exact frequency adjustments which are far superior to potentiometers. Additionally, the **XCard** can be configured for high-pass, low-pass and full range operation. With slight modifications, many crossover frequencies and slope configurations can be achieved.

THE RESULT: Increased system design flexibility with a precise electronic crossover without the limitations of conventional potentiometer designs.

◆ MOSFET Devices

Rockford Fosgate is one of the few manufacturers in the sound community to utilize MOSFET devices in both the **power supply** and the **output stages**. **MOSFET (Metal Oxide Semiconductor Field Effect Transistor)** devices offer several important inherent advantages over the 30 year old technology of bi-polar design. These advantages include: thermal stability, switching speed, ultra low output impedance and wider bandwidth linearity. In addition, MOSFETs and vacuum tubes share many important operating characteristics. However, the MOSFET device is much faster, wider in bandwidth, measurably lower in distortion and far more linear than vacuum tubes.

THE RESULT: Operational characteristics of vacuum tubes without the performance limitations of tube design.

DESIGN FEATURES

1. **Cast Aluminum Heatsink** – The cast aluminum heatsink of the Punch amplifier dissipates heat generated by the amplifier's circuitry. The inherent advantage of casting provides a 30% improvement of cooling over conventional extrusion heatsink designs.
2. **End Caps** – Interchangeable end caps conceal the wiring and input cables, giving the amplifier a clean "stealth" look.

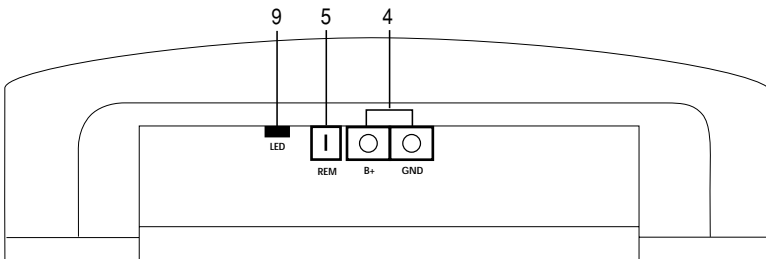
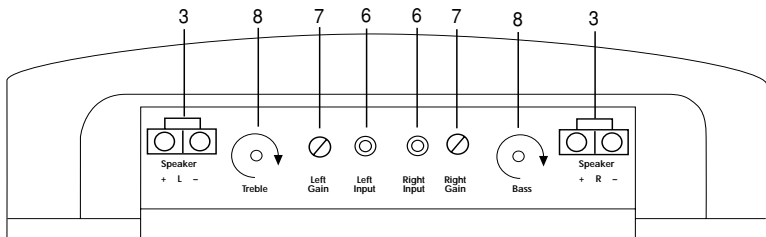

3. **Speaker Terminals** – The heavy duty, gold-plated terminal block connectors (+ and -) will accept wire sizes from 8 AWG to 18 AWG. These gold-plated connectors are immune to corrosion that can cause signal deterioration.
4. **Power Terminals** – The power and ground connectors on the Punch amplifier are gold-plated and will accommodate up to 8 AWG wire maximizing the input current capability of the amplifier.
5. **REM Terminal** – This spade terminal is used for the AP (auto power) or remote turn on of the Punch amplifier.

6. **RCA Input Jacks** – The industry standard RCA jacks provide easy connections for signal level input. They are gold-plated to resist the signal degradation caused by corrosion.
7. **Input Sensitivity Controls** – The input level controls are preset for 825mV which will match the output of most source units. They can be adjusted to match input levels ranging from 150mV to 3V.
8. **Punch Equalization Controls** – The Punch EQ helps correct for acoustical deficiencies of the listening environment. The Bass control allows a narrow band adjustment of up to 18dB centered at 45Hz. The Treble control is a wide band hinged adjustment with a maximum of 18dB at 20kHz. The Punch EQ can be bypassed by turning the controls to their minimum or counterclockwise position.
9. **LED Power Indicator** – The LED illuminates when the unit is turned on.
10. **XCard (Internal Crossover)** – This built-in crossover card is configurable for a multitude of operating frequencies. The orientation of the card in its socket determines the function of high-pass, low-pass, or full range operation.

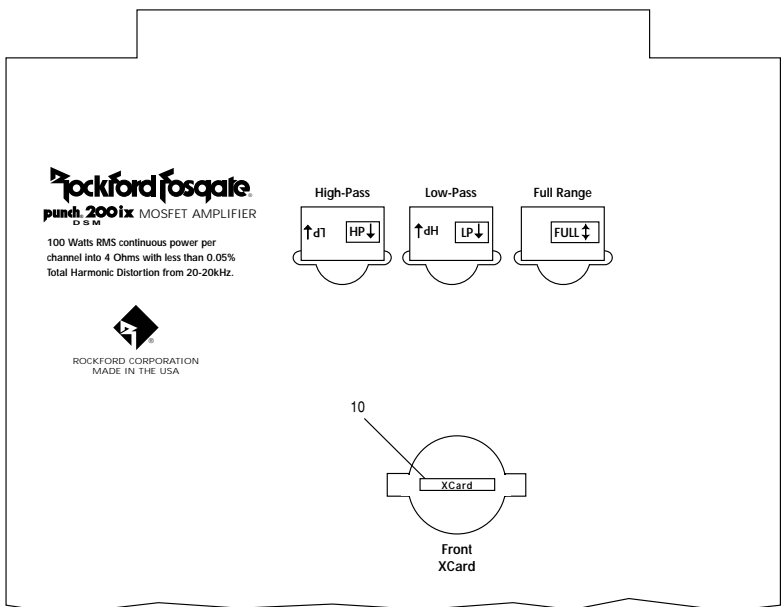

INSTALLATION CONSIDERATIONS

The following is a list of tools you will need for installing the Punch amplifier:

Allen wrenches 7/64" & 3/32" (included)	Voltmeter
Wire strippers	Battery post wrench
Electric hand drill w/assorted bits	Wire cutters
Wire crimpers	Assorted connectors

This section focuses on some of the vehicle considerations for installing your new Punch amplifier. Checking your battery and present sound system, as well as pre-planning your system layout and best wiring routes will save installation time. When deciding how to lay out your new system, be sure that each component will be easily accessible for making adjustments.

Before beginning any installation, be sure to follow these simple rules:

1. Be sure to carefully read and understand the instructions before attempting to install the amplifier.
2. **For safety**, disconnect the negative lead from the battery prior to beginning the installation.
3. For easier assembly, we suggest you run all wires prior to mounting your amplifier in place.
4. Route all of the RCA cables close together and away from any high current wires.
5. Use high quality connectors for a reliable installation and to minimize signal or power loss.
6. **Think before you drill!** Be careful not to cut or drill into gas tanks, fuel lines, brake or hydraulic lines, vacuum lines or electrical wiring when working on any vehicle.
7. Never run wires underneath the vehicle. Running the wires inside the vehicle provides the best protection.
8. Avoid running wires over or through sharp edges. Use rubber or plastic grommets to protect any wires routed through metal, especially the firewall.
9. **ALWAYS** protect the battery and electrical system from damage with proper fusing. Install a fuseholder and appropriate fuse on the +12V power wire within 18" (45.7 cm) of the battery terminal.
10. When grounding to the chassis of the vehicle, scrape all paint from the metal to ensure a good, clean ground connection. Grounding connections should be as short as possible and always be connected to metal that is welded to the main body, or chassis, of the vehicle.

MOUNTING LOCATION

The mounting location and position of your amplifier will have a great effect on its ability to dissipate the heat generated during normal operation. The design of our cast aluminum heatsink serves to easily dissipate the heat generated over a wide range of operating conditions. However, to maximize the performance of your amplifier, care should be taken to ensure adequate ventilation.

Trunk Mounting

Mounting the amplifier vertically on a surface with the fin grooves running up and down will provide the best cooling of the amplifier.

Mounting the amplifier on the floor of the trunk will work but provides less cooling capability than vertical mounting.

Mounting the amplifier upside down to the rear deck of the trunk will not provide proper cooling and will severely affect the performance of the amplifier and is strongly **not** recommended.

Passenger Compartment Mounting

Mounting the amplifier in the passenger compartment will work as long as you provide a sufficient amount of air for the amplifier to cool itself. If you are going to mount the amplifier under the seat of the vehicle, you must have at least 1" (2.54cm) of air gap around the amplifier's heatsink.

Mounting the amplifier with less than 1" (2.54cm) of air gap around the amplifier's heatsink in the passenger compartment will not provide proper cooling and will severely affect the performance of the amplifier and is strongly **not** recommended.

Engine Compartment Mounting

Rockford Fosgate amplifiers should **never** be mounted in the engine compartment. Not only will this void your warranty but could create an embarrassing situation caused by the ridicule from your friends.

BATTERY AND CHARGING

Amplifiers will put an increased load on the vehicle's battery and charging system. We recommend checking your alternator and battery condition to ensure that the electrical system has enough capacity to handle the increased load of your stereo system. Stock electrical systems which are in good condition should be able to handle the extra load of any Rockford amplifier without problems, although battery and alternator life can be reduced slightly. To maximize the performance of your Rockford Fosgate amplifier, we suggest the use of a heavy duty battery, high output alternator and an energy storage capacitor.

WIRING THE SYSTEM

CAUTION: Avoid running power wires near the low level input cables, antenna, power leads, sensitive equipment or harnesses. The power wires carry substantial current and could induce noise into the audio system.

- **For safety**, disconnect the negative lead from the battery prior to beginning the installation.

1. Plan the wire routing. Take care when running signal level RCA cables to keep them close together but isolated from the amplifier's power cables and any high power auto accessories, especially electric motors. This is done to prevent coupling the noise from radiated electrical fields into the audio signal. When feeding the wires through the firewall or any metal barrier, protect them with plastic or rubber grommets to prevent short circuits. Leave the wires long at this point to adjust for a precise fit at a later time.
2. Prepare the **Power** cable for attachment to the amplifier by stripping 5/8" of insulation from the end of the wire. The use of 8 gauge power cable can interfere with the installation of the end caps. Proper wire dress can prevent this from occurring. To prevent the wire from fraying, strip the insulation at a 45° angle. Insert the bared wire into the B+ terminal with the long side of the insulation on the top. Bend the cable down at a 90° angle. Tighten the set screw to secure the cable in place.

Punch 40ix, 60ix, 100ix

Trim the power cable to within 18" of the battery and install the protective rubber boot, which is packed with the fuseholder, over the end of the wire. Strip 3/8" of insulation from the wire and insert into the end of the fuseholder, then crimp it in place. Slide the rubber boot into place to cover the connection. Use the section of cable that was trimmed earlier and connect it to the other end of the fuseholder.

Punch 200ix

Mount the fuseholder within 18" of the battery using two (2) #8 screws. Disassemble the fuseholder. You should have 2 black plastic end caps, 2 gold-plated fuse clips, a plastic spacer and the fuseholder body. Trim the amplifier power cable to reach the fuseholder and strip the wire 3/8". Slide one of the end caps over the wire (narrow end first) and insert the wire into one of the fuse clips. Tighten the set screw. Screw the black end cap to the fuseholder body to secure the cable. Use the section of cable that was trimmed earlier and connect it to the other end of the fuseholder. Install the plastic spacer in the fuseholder and attach the cable to the fuseholder body.

NOTE: The B+ cable **MUST** be fused 18" or less from the vehicle's battery. Install the fuseholder under the hood and prepare the cable ends as stated above. Connections should be water tight.

3. Strip 3/8" from the battery end of the power cable and crimp the large ring terminal to the cable. Use the ring terminal to connect to the battery positive terminal. **Do not install the fuse at this time.**
4. Prepare a length of cable to be used for the ground connection. Strip 5/8" of insulation from the end of the cable as described previously and connect to the appropriate terminal of the amplifier. Prepare the chassis ground by scraping any paint from the metal surface and thoroughly clean the area of all dirt and grease. Strip the other end of the wire and attach a ring connector. Fasten the cable to the chassis using a non-anodized screw and star washers.

5. Prepare the REM turn-on wire for connection to the amplifier by stripping 5/8" of insulation from the wire end and crimping an insulated spade connector in place. Slide the connector over the REM terminal on the amplifier. Connect the other end of the REM wire to a switched 12 volt positive source. The switched signal is usually taken from the source unit's auto antenna or the accessory lead. If the source unit does not have these outputs available, the recommended solution is to wire a mechanical switch in line with a 12 volt source to activate the amplifier.
6. Connect the source signal to the amplifier by plugging the RCA cables into the input jacks at the amplifier.
7. Connect the speakers. Strip the speaker wires 5/8" and insert into the appropriate terminal on the amplifier. Insert the bared wire into the speaker terminal and tighten the set screw to secure into place. Be sure to maintain proper speaker polarity. ***DO NOT chassis ground any of the speaker leads as unstable operation may result.***
8. Perform a final check of the completed system wiring to ensure that all connections are accurate. Check all power and ground connections for frayed wires and loose connections which could cause problems.
9. After the final inspection is complete, install the power fuse and enjoy listening. During the initial listening period, you may need to "fine tune" any phasing and level settings within your particular vehicle. To aid in this procedure, play a track with high musical content and cruise around your neighborhood. After fully evaluating the transient response of your system and making any final adjustments, all your neighbors within a 1 mile radius will assume that you have just successfully completed another upgrade to your audio system for which they will probably spill thumbtacks on your driveway.

USING THE XCARD

The crossover functions are controlled through the use of an XCard and can be set for high-pass, low-pass or full range operation. Each crossover card has two faces: one face operates **Full Range**, the other has arrows to indicate the edge for selecting **HP** (high-pass) or **LP** (low-pass) operation. Orient the card with the desired operating edge, indicated by the arrow, toward the socket terminals inside the amplifier. Firmly, but carefully, plug the card into the socket.

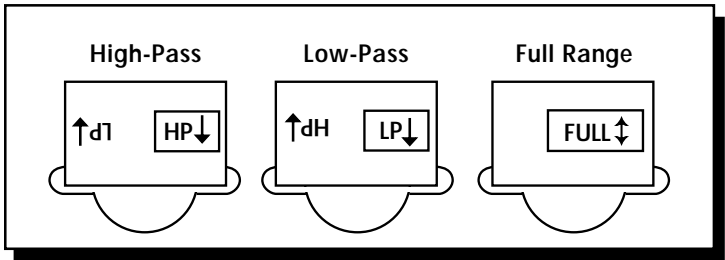

The crossover point can be altered by changing the resistor value. Use the following formula to select the appropriate resistor value to be placed on the XCard.

$$\frac{3386}{f_o} = R \text{ (in } k\Omega \text{) for } .047\mu\text{f cap}$$

The actual formula is:

$$\frac{7234}{f_o} = R \text{ (in } k\Omega \text{) for } .022\mu\text{f cap}$$

$$R = \frac{1}{2\pi f_o c}$$

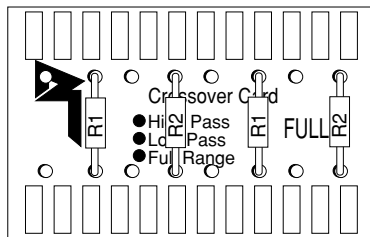

Where: $R = \Omega$

f_o = desired crossover frequency

c = capacitor in farads

ex: $.047 \times 10^{-6}$ for .047mf cap

BASIC CONNECTIONS

Power Connections

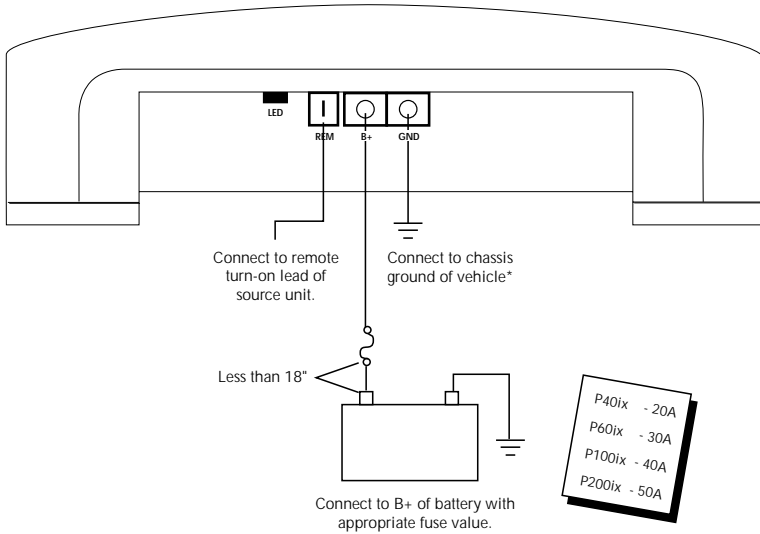

*Keep grounds as short as possible.

Stereo Operation

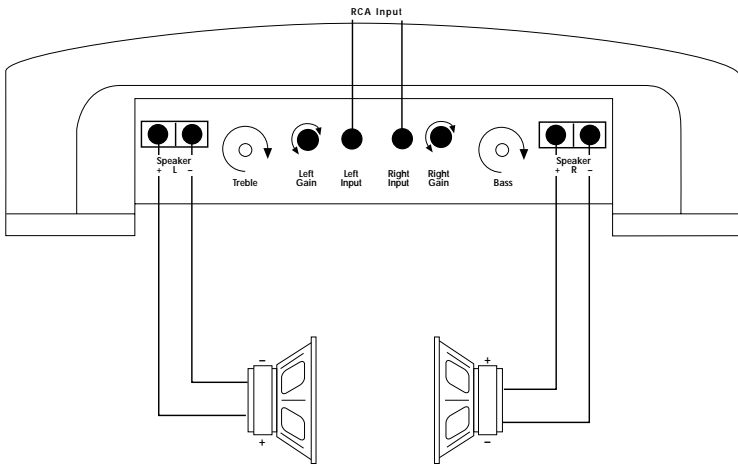

- **RCA** inputs are connected to both left and right channels.
- **Gain** for left and right channels operate independently.
- **Impedance** for each channel should be 2Ω minimum.
- **XCard** can be set for High-Pass, Low-Pass or Full Range.

Mono Operation

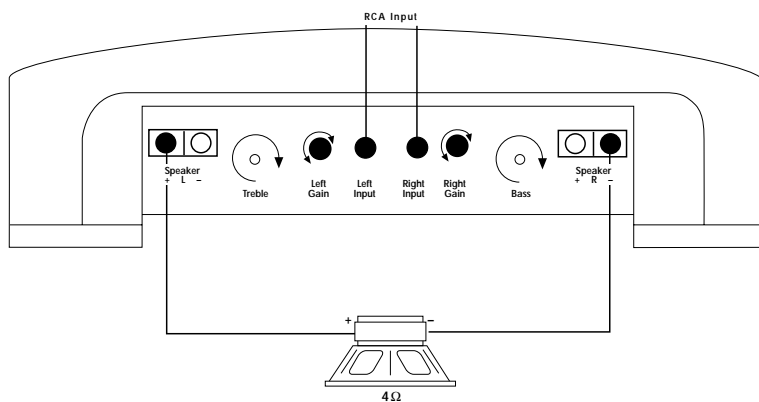

- **RCA** inputs are connected to both left and right channels.
- **Gain** for left and right channels are set equally to balance the subwoofer.
- **Impedance** for mono channel should be 4Ω minimum.
- **XCard** can be set for High-Pass, Low-Pass or Full Range.

Stereo/Mono Operation

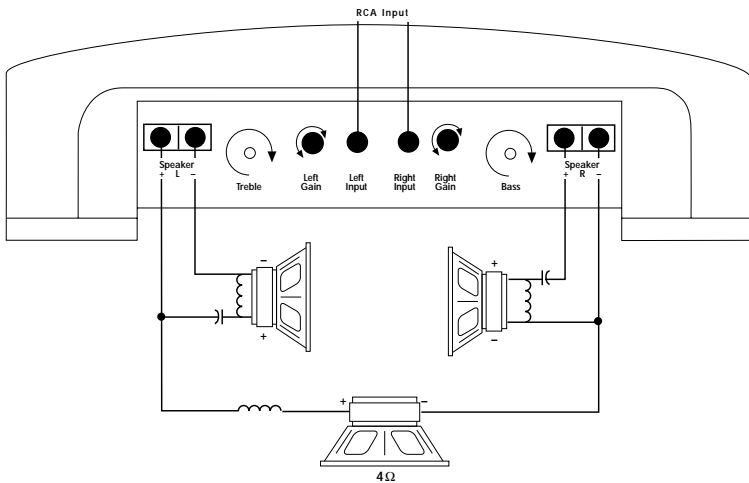

- **RCA** inputs are connected to both left and right channels.
- **Gain** for left and right channels are set equally to balance the subwoofer.
- **Impedance** for each channel should be 2Ω minimum.
- **Impedance** for mono channel should be 4Ω minimum.
- **XCard** is set for Full Range

SYSTEM DIAGRAMS

2-Way System

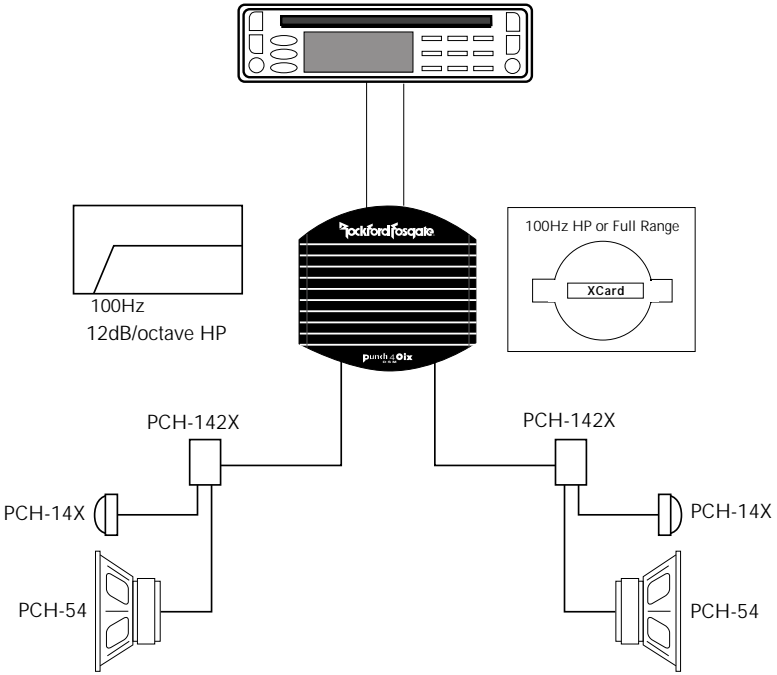

3-Way System

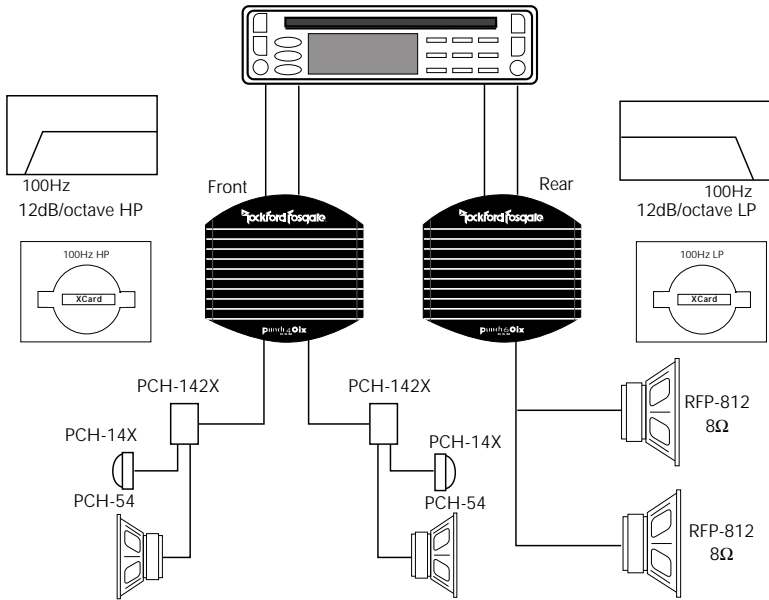

4-Way System

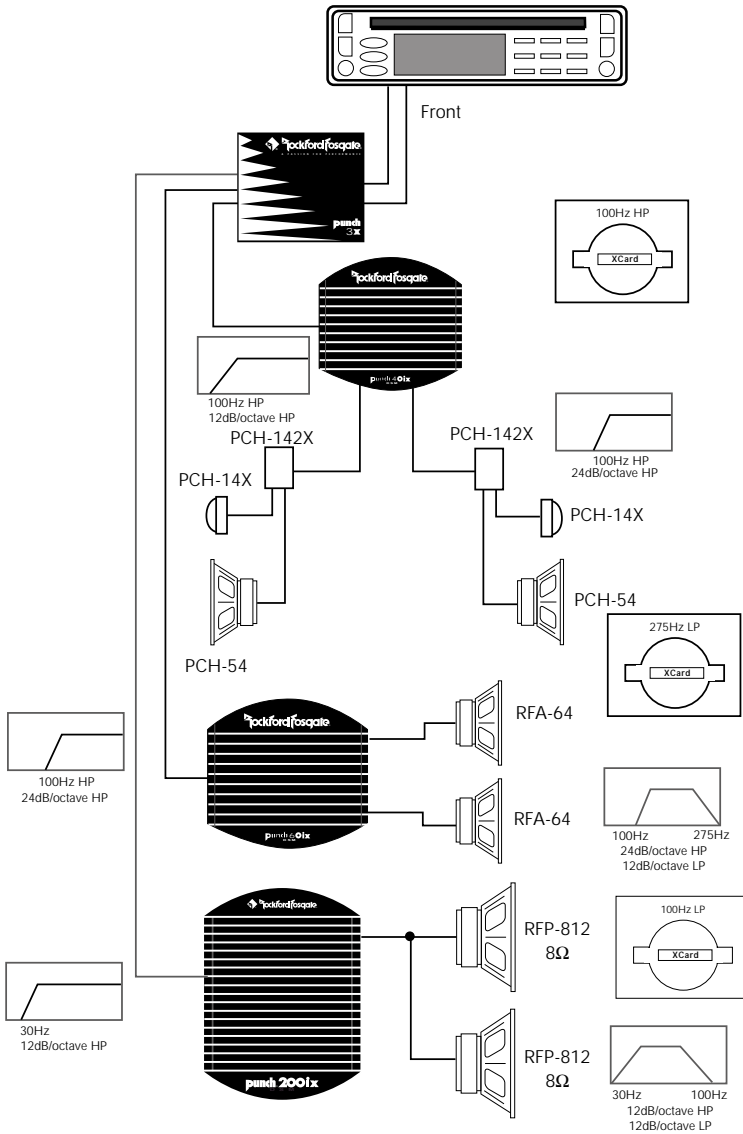

4-Way System w/Fadable Rear Stage

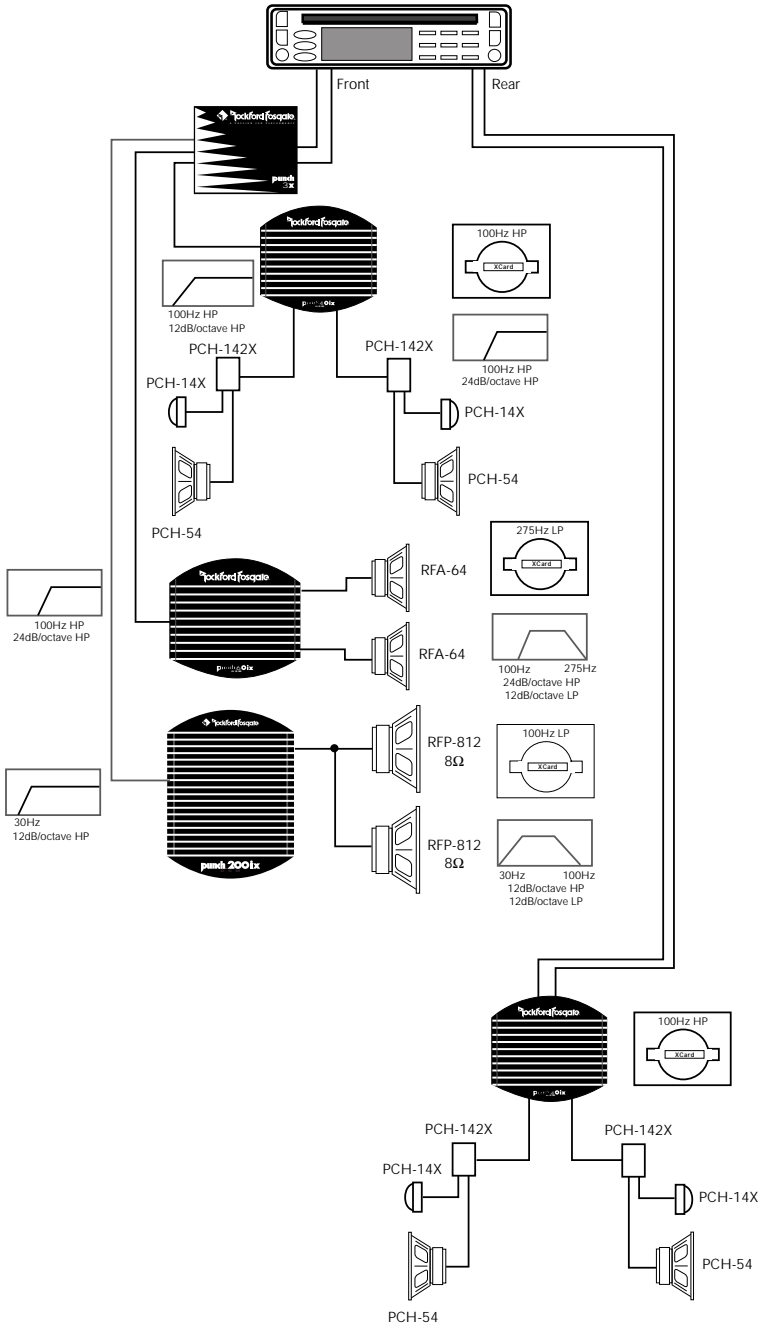

TROUBLESHOOTING

Symptom	Diagnosis	Remedy
Amplifier does not turn on (Power LED is off)	Voltage applied to the REM terminal of the amplifier is not between 10.5 and 15.5 volts or there is no voltage present.	Check the alternator, battery, fuse, and wiring and repair as necessary. If the voltage is above 15.5 volts, have the electrical system inspected by an authorized car service center.
	Voltage to the B+ terminal of the amplifier is not between 10.5 and 15.5 volts or there is no voltage present.	Check the alternator, battery, fuse, and wiring and repair as necessary. If the voltage is above 15.5 volts, have the electrical system inspected by an authorized car service center.
	Amplifier is not properly grounded.	Check wiring and repair as necessary.
Amplifier has no sound (Power LED is on)	RCA Input from source unit is not connected or not functioning properly.	Check connections, substitute with known working source and cables and repair or replace as necessary.
	XCard is missing or not placed properly in crossover slots.	Check XCard position and repair or replace as necessary.
	Speaker leads are shorted to each other or to the chassis of the vehicle.	Disconnect existing speakers and test with known working speakers and wires. If amplifier plays, check and repair wiring and installation of speakers as necessary.
	Speakers are defective.	Disconnect existing speakers and test with known working speakers. If amplifier plays, check and repair speakers as necessary.

Symptom	Diagnosis	Remedy
Speaker Output Low or Distorted	Input gain signal for amplifier is incorrectly set.	Readjust input gains of amplifier.
	Source unit output too low or source unit has no output.	Check system with known working source and repair or replace original source as needed.
	XCard is missing or not placed properly in cross-over slots.	Check XCard position and repair or replace as necessary.
	Low battery voltage or large voltage drops to the amplifier under load.	Check the alternator, battery, fuse, and power and ground wiring. Repair as necessary.
Amplifier Noise (Turn-on Pop)	Voltage spike from output of preceding component is entering amplifier through input signal.	Disconnect input signal to amplifier and turn amplifier on and off. If noise is eliminated, connect REM lead of amplifier to source unit with a delay turn-on module.
	Voltage spike from remote turn-on lead is entering through REM input terminal.	Use a different 12 volt source for REM lead of amplifier. (i.e., battery direct) If noise is eliminated, use a relay to isolate amplifier from noisy turn-on output.

Symptom	Diagnosis	Remedy
Engine Noise	Noise is radiating into RCA signal cable.	Check connections, run the RCA cables on a different route away from sources of high voltage.
	Bad component in the signal chain.	Check connections, bypass additional components (crossovers and equalizers) between the source unit and the amplifier. Connect one component at a time to determine the culprit. Repair or replace components as necessary.
	Noise is radiating into speaker cables.	Disconnect existing speakers and connect a test speaker to the output terminals of the amplifier. If noise is gone, reroute the speaker cables away from sources of high voltage.
	Multiple grounds in the audio system.	Check ground connections and connect amplifiers, signal processors, and other components to a central location or try a different grounding point on the chassis.
	Ground loop between source unit and antenna.	Check connections, disconnect antenna from source unit. If noise is gone, install an antenna ground loop isolator.

- If noise persists, see your Authorized Rockford Fosgate Dealer.

DYNAMIC POWER MEASUREMENTS

About the Dynamic Power Measurements

The Audio Graph PowerCube is a test instrument used to measure the output of an amplifier in accordance with IHF-202 industry standards. The IHF-202 standard is a dynamic power measurement and was developed as a means of measuring power in a manner that best represents the Real World operation of an amplifier. Many manufacturers, including Rockford Fosgate, at times will measure amplifier power into a fixed resistor (4 Ohm, 2 Ohm). While this method is useful in some types of evaluation and testing, it is not representative of an amplifier that is connected to a speaker and playing music.

Music

Music is dynamic; the sound waves are complex and constantly changing. In order to simulate this, the IHF-202 standard calls for the input signal to the amplifier to be a 1kHz burst tone. This signal is input (on for 20 milliseconds) and reduced 20dB for 480 milliseconds. The signal is gradually increased in level until the amplifier's output exceeds 1% Total Harmonic Distortion (THD). At 1% distortion becomes audible, therefore, any power produced above that level is considered *not usable*. Many manufacturers represent their amplifiers' output power in excess of 10% distortion. They use many names for this measurement, such as Total Maximum Power or Maximum Output Power. This is not indicative of the *actual usable output power*.

Listening to Loudspeakers - Not Resistors

A loudspeaker is not a resistor. A resistor's value (resistance measured in ohms) is fixed. A loudspeaker's impedance is dynamic. It is constantly changing in value, dependent upon the frequency of the input signal. Therefore, measuring power with the amplifier loaded into a 4 ohm resistor is not the same as measuring power with the amplifier connected to a 4 ohm speaker. Most people do not listen to music through a resistor.

A 4 Ohm speaker may experience a drop in impedance 4-6 times lower than its nominal (printed) impedance. A speaker will also create phase shifts in the signal that is passed through it. These phase shifts happen because a speaker is an inductor (voice coil) and a capacitor (compliance of the surround/spider), as well as a resistor (voice coil wire).

To simulate a speaker the Audio Graph PowerCube measures output power into 20 different loads. It tests at 8 Ohms, 4 Ohms, 2 Ohms and 1 Ohm. Each of these impedances is also tested at -60° , -30° , 0° , $+30^\circ$ and $+60^\circ$ phase angles. These different impedances and phase angles represent the shifts in impedance and phase that can occur in a typical loudspeaker.

Information Cubed

The data acquired in the testing procedure is then graphed in the form of a 3-dimensional cube. Hence the name **PowerCube**.

The *Phase Angle* is expressed on the horizontal axis, the *Output Voltage* is presented on the vertical axis and the *Impedance* is displayed on the Z axis. *Output Power*, in watts, is listed on the left hand side for each impedance at each phase angle.

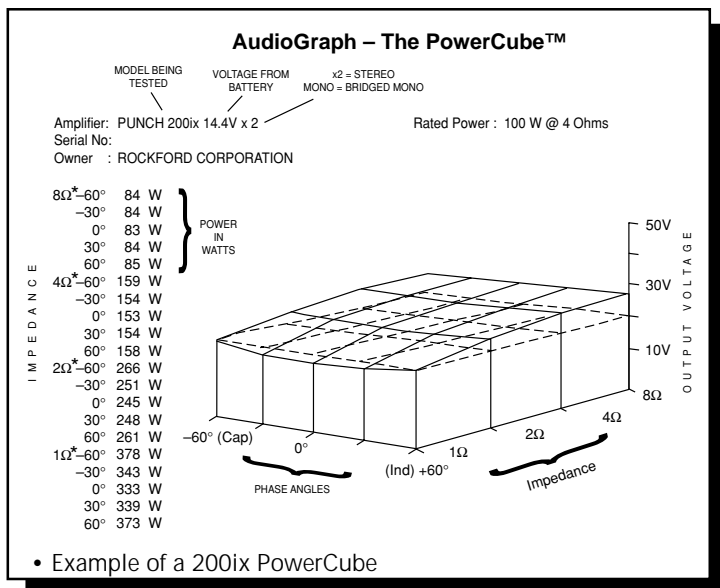

What is an Amplifier?

An amplifier by definition is a voltage generating device, recreating the signal which is input to it identically but with increased volume. It will be connected to a reactive load (the speaker). The impedance of this load and phase of the signal passing through the load will vary, dependent upon the frequency of the input signal (music).

Therefore, a perfect amplifier will be able to maintain the same output voltage regardless of load characteristics and will not alter the signal it is reproducing. A perfect amplifier when measured by the AudioGraph PowerCube would present data that forms a perfect cube. Unfortunately, amplifiers are not perfect. The laws of physics generally prevent it. A great amplifier is about the best one can hope to attain.

As you can see by the PowerCube and as you will experience by listening, your Punch amplifier is a GREAT AMPLIFIER!

SPECIFICATIONS

	PUNCH 40ix	PUNCH 60ix	PUNCH 100ix	PUNCH 200ix
Dynamic Power Rating (IHF-202 Standard) - Measured at 14.4 Volts				
Mono into a 4Ω Load	160 Watts	260 Watts	420 Watts	500 Watts
Per channel into a 2Ω Load	75 Watts	130 Watts	200 Watts	240 Watts
Per channel into a 4Ω Load	40 Watts	80 Watts	110 Watts	150 Watts
Continuous Power Rating (Competition Standard) - Measured at 12.6 Battery Volts				
RMS continuous power per channel , both channels driven into a 4Ω load from 20 to 20,000 Hz with less than 0.05% Total Harmonic Distortion (THD)	20 Watts	30 Watts	50 Watts	100 Watts
RMS continuous power per channel , both channels driven into a 2Ω load from 20 to 20,000 Hz, with less than 0.1% Total Harmonic Distortion (THD)	40 Watts	60 Watts	100 Watts	200 Watts
RMS continuous power mono into a 4Ω load from 20 to 20,000 Hz, with less than 0.1% Total Harmonic Distortion (THD)	80 Watts	120 Watts	200 Watts	400 Watts
Signal-to-Noise Ratio				> 100dB A-weighted

	PUNCH 40ix	PUNCH 60ix	PUNCH 100ix	PUNCH 200ix
Dimensions	9-5/8" (24.4cm) W 9-5/8" (24.4cm) L 2-5/8" (6.6cm) H	9-5/8" (24.4cm) W 10-5/8" (27.0cm) L 2-5/8" (6.6cm) H	9-5/8" (24.4cm) W 11-5/8" (29.5cm) L 2-5/8" (6.6cm) H	9-5/8" (24.4cm) W 12-5/8" (32.0cm) L 2-5/8" (6.6cm) H

Bandwidth 10Hz to 200kHz \pm 3dB

Damping Factor @ 4 Ω At output connector - Over 200

Frequency Response 20Hz to 20kHz \pm 1.0dB / 10Hz to 100kHz \pm 0.5dB

Slew Factor 50 Volts μ s

IM Distortion (IHF) Less than 0.05%

Input Sensitivity Variable from 150mV to 3V
Preset at the factory for 500mV

Protection RTP/NOMAD - Internal analog-computer output protection circuitry limits power in case of overload. Thermal switch shuts down the amplifier in case of overheating.

Battery Fusing Rates (External to Amplifier) 20 Amps 30 Amps 40 Amps 50 Amps

Fuse Type ATC ATC ATC ATC

Equalization Bass: +18dB Maximum at 45Hz
Treble: +12dB Maximum at 20kHz

Input Impedance 20,000 Ohms

Specifications subject to change without notice.

WARRANTY INFORMATION

Rockford Fosgate warrants all electronics to the original consumer/purchaser to be free from defects in materials or workmanship for a period of three (3) years. We will cover parts and labor provided the product was purchased from an Authorized Rockford Fosgate Dealer. This warranty does not apply to any product on which the seals and/or serial number have been broken, removed, tampered with, defaced or altered in any manner. This warranty only applies to the original consumer/purchaser and is not transferable.

Electronics found to be defective during the warranty period will be repaired or replaced at Rockford Fosgate's discretion. Repaired or replaced electronics will be covered by the balance of the original warranty period only. Rockford Fosgate shall not be responsible for any incidental or consequential damages resulting from a defect in electronics. Some states do not allow the exclusion or limitation of incidental or consequential damages, so the previous limitation may not be applicable.

The warranty does not cover any appearance item, any cost or expense related to the removal or reinstallation of the product, any accessory used in conjunction with the product, damage to the product resulting from alteration, accident, misuse or abuse, or improper installation. This warranty does not apply if the parts or labor, which would otherwise be provided without charge under this warranty, are obtained from any source other than Rockford Fosgate or an Authorized Rockford Fosgate Service Center.

This warranty is the only express warranty and does not create any implied warranties. Rockford Fosgate limits its obligations under any implied warranties under state laws to a period not to exceed the written warranty period. Some states do not allow limitation on how long an implied warranty lasts, so the above limitation may not apply. This warranty applies only to products sold in the United States of America or its possessions. For warranty outside the U.S.A., please contact the nearest Authorized Rockford Fosgate Dealer. This warranty gives the consumer specific legal rights, and the consumer may have other rights which vary from state to state.

A defective product must be shipped prepaid to the Authorized Rockford Fosgate Dealer from which the consumer purchased the product or to the Rockford Fosgate factory in Tempe, Arizona in the original factory carton or equivalent. Any shipping loss or damage will be borne by the consumer or the consumer's shipper. A consumer returning a product to the factory must call (800) 669-9899 for a Return Authorization Number. All shipments shall be clearly marked with the Return Authorization Number on the outside of the shipping carton.

Ship to:
Rockford Corporation
Warranty Repair Department
2055 E. 5th Street
Tempe, AZ 85281 U.S.A.
Return Authorization Number: _____

NOTES

NOTES

Rockford Fosgate
Rockford Corporation
546 South Rockford Drive
Tempe, Arizona 85281 U.S.A.
In U.S.A., (602) 967-3565
In Canada, Fax Korbon (905) 567-1929
In Europe, Fax (49) 4207-801250
In Japan, Fax (81) 559-79-1265

Free Manuals Download Website

<http://myh66.com>

<http://usermanuals.us>

<http://www.somanuals.com>

<http://www.4manuals.cc>

<http://www.manual-lib.com>

<http://www.404manual.com>

<http://www.luxmanual.com>

<http://aubethermostatmanual.com>

Golf course search by state

<http://golfingnear.com>

Email search by domain

<http://emailbydomain.com>

Auto manuals search

<http://auto.somanuals.com>

TV manuals search

<http://tv.somanuals.com>