

BI-AMP MONITOR DS-8/7/5

24-BIT/192 KHZ

OWNER'S MANUAL

Thank you for purchasing the Roland Bi-Amp Monitor DS-8/7/5.

Before using this unit, carefully read the sections entitled: "IMPORTANT SAFETY INSTRUCTIONS" (p. 2), "USING THE UNIT SAFELY" (p. 3, 4), and "IMPORTANT NOTES" (p. 5). These sections provide important information concerning the proper operation of the unit. Additionally, in order to feel assured that you have gained a good grasp of every feature provided by your new unit, Owner's manual should be read in its entirety. The manual should be saved and kept on hand as a convenient reference.

Main Features

● In Pursuit of High Sound Quality

The DS-8/7/5 powered monitor uses a two-way, bi-amplifier design to achieve high sound quality.

The LF driver and dome HF driver use separate amps sections for LF and HF, ensuring optimal sound quality.

In particular, the DS-8/7 feature completely discrete DC power amps for the highest possible quality.

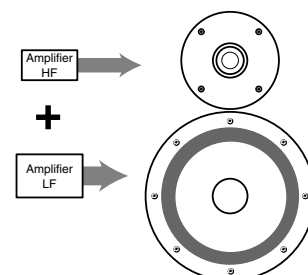

● Analog Input

In addition to an XLR connector, which provides for balanced input, a 1/4" TRS phone jack accommodating either balanced or unbalanced input is also provided. This assures broad-ranging connectivity.

● Digital Input

The digital inputs (coaxial and optical) support 24-bit digital audio data at sampling rates up to 192 kHz. AES/EBU professional audio format digital input is also provided.

Digitally input signals are reproduced faithfully through 24-bit D/A conversion, thus preventing noise or a drop in sound quality.

You can use the monitors with a wide variety of equipment and applications through selective use of the analog and digital settings.



● Magnetically Shielded Low- and High-Frequency Drivers

This allows you to use the speakers next to CRT displays.

Copyright © 2004 ROLAND CORPORATION

All rights reserved. No part of this publication may be reproduced in any form without the written permission of ROLAND CORPORATION.

WARNING: To reduce the risk of fire or electric shock, do not expose this apparatus to rain or moisture.

  
ATTENTION: RISQUE DE CHOC ELECTRIQUE NE PAS OUVRIR
CAUTION: TO REDUCE THE RISK OF ELECTRIC SHOCK, DO NOT REMOVE COVER (OR BACK). NO USER-SERVICEABLE PARTS INSIDE. REFER SERVICING TO QUALIFIED SERVICE PERSONNEL.



The lightning flash with arrowhead symbol, within an equilateral triangle, is intended to alert the user to the presence of uninsulated "dangerous voltage" within the product's enclosure that may be of sufficient magnitude to constitute a risk of electric shock to persons.



The exclamation point within an equilateral triangle is intended to alert the user to the presence of important operating and maintenance (servicing) instructions in the literature accompanying the product.

INSTRUCTIONS PERTAINING TO A RISK OF FIRE, ELECTRIC SHOCK, OR INJURY TO PERSONS.

IMPORTANT SAFETY INSTRUCTIONS SAVE THESE INSTRUCTIONS

WARNING - When using electric products, basic precautions should always be followed, including the following:

1. Read these instructions.
2. Keep these instructions.
3. Heed all warnings.
4. Follow all instructions.
5. Do not use this apparatus near water.
6. Clean only with a dry cloth.
7. Do not block any of the ventilation openings. Install in accordance with the manufacturers instructions.
8. Do not install near any heat sources such as radiators, heat registers, stoves, or other apparatus (including amplifiers) that produce heat.
9. Do not defeat the safety purpose of the polarized or grounding-type plug. A polarized plug has two blades with one wider than the other. A grounding type plug has two blades and a third grounding prong. The wide blade or the third prong are provided for your safety. If the provided plug does not fit into your outlet, consult an electrician for replacement of the obsolete outlet.
10. Protect the power cord from being walked on or pinched particularly at plugs, convenience receptacles, and the point where they exit from the apparatus.
11. Only use attachments/accessories specified by the manufacturer.
12. Unplug this apparatus during lightning storms or when unused for long periods of time.
13. Refer all servicing to qualified service personnel. Servicing is required when the apparatus has been damaged in any way, such as power-supply cord or plug is damaged, liquid has been spilled or objects have fallen into the apparatus, the apparatus has been exposed to rain or moisture, does not operate normally, or has been dropped.

For the U.K.

WARNING: THIS APPARATUS MUST BE EARTHED

IMPORTANT: THE WIRES IN THIS MAINS LEAD ARE COLOURED IN ACCORDANCE WITH THE FOLLOWING CODE.
GREEN-AND-YELLOW: EARTH, BLUE: NEUTRAL, BROWN: LIVE

As the colours of the wires in the mains lead of this apparatus may not correspond with the coloured markings identifying the terminals in your plug, proceed as follows:

The wire which is coloured GREEN-AND-YELLOW must be connected to the terminal in the plug which is marked by the letter E or by the safety earth symbol  or coloured GREEN or GREEN-AND-YELLOW.

The wire which is coloured BLUE must be connected to the terminal which is marked with the letter N or coloured BLACK.

The wire which is coloured BROWN must be connected to the terminal which is marked with the letter L or coloured RED.

USING THE UNIT SAFELY

INSTRUCTIONS FOR THE PREVENTION OF FIRE, ELECTRIC SHOCK, OR INJURY TO PERSONS

About ⚠ WARNING and ⚠ CAUTION Notices

⚠ WARNING	Used for instructions intended to alert the user to the risk of death or severe injury should the unit be used improperly.
⚠ CAUTION	Used for instructions intended to alert the user to the risk of injury or material damage should the unit be used improperly. * Material damage refers to damage or other adverse effects caused with respect to the home and all its furnishings, as well to domestic animals or pets.

About the Symbols

	The ⚠ symbol alerts the user to important instructions or warnings. The specific meaning of the symbol is determined by the design contained within the triangle. In the case of the symbol at left, it is used for general cautions, warnings, or alerts to danger.
	The ⚡ symbol alerts the user to items that must never be carried out (are forbidden). The specific thing that must not be done is indicated by the design contained within the circle. In the case of the symbol at left, it means that the unit must never be disassembled.
	The ● symbol alerts the user to things that must be carried out. The specific thing that must be done is indicated by the design contained within the circle. In the case of the symbol at left, it means that the power-cord plug must be unplugged from the outlet.

ALWAYS OBSERVE THE FOLLOWING

⚠ WARNING

- Before using this unit, make sure to read the instructions below, and the Owner's Manual.
- Connect mains plug of this model to a mains socket outlet with a protective earthing connection.
- Do not open or perform any internal modifications on the unit.
- Do not attempt to repair the unit, or replace parts within it (except when this manual provides specific instructions directing you to do so). Refer all servicing to your retailer, the nearest Roland Service Center, or an authorized Roland distributor, as listed on the "Information" page.
- Never use or store the unit in places that are:
 - Subject to temperature extremes (e.g., direct sunlight in an enclosed vehicle, near a heating duct, on top of heat-generating equipment); or are
 - Damp (e.g., baths, washrooms, on wet floors); or are
 - Humid; or are
 - Exposed to rain; or are
 - Dusty; or are
 - Subject to high levels of vibration.
- Make sure you always have the unit placed so it is level and sure to remain stable. Never place it on stands that could wobble, or on inclined surfaces.

⚠ WARNING

- The unit should be connected to a power supply only of the type described in the operating instructions, or as marked on the rear side of unit.
- Use only the attached power-supply cord. Also, the supplied power cord must not be used with any other device.
- Do not excessively twist or bend the power cord, nor place heavy objects on it. Doing so can damage the cord, producing severed elements and short circuits. Damaged cords are fire and shock hazards!
- This unit, either alone or in combination with an amplifier and headphones or speakers, may be capable of producing sound levels that could cause permanent hearing loss. Do not operate for a long period of time at a high volume level, or at a level that is uncomfortable. If you experience any hearing loss or ringing in the ears, you should immediately stop using the unit, and consult an audiologist.
- Do not allow any objects (e.g., flammable material, coins, pins); or liquids of any kind (water, soft drinks, etc.) to penetrate the unit.
- In households with small children, an adult should provide supervision until the child is capable of following all the rules essential for the safe operation of the unit.



⚠ WARNING

- Immediately turn the power off, remove the power cord from the outlet, and request servicing by your retailer, the nearest Roland Service Center, or an authorized Roland distributor, as listed on the "Information" page when:
 - The power-supply cord, or the plug has been damaged; or
 - If smoke or unusual odor occurs
 - Objects have fallen into, or liquid has been spilled onto the unit; or
 - The unit has been exposed to rain (or otherwise has become wet); or
 - The unit does not appear to operate normally or exhibits a marked change in performance.
- Protect the unit from strong impact. (Do not drop it!)
- Do not force the unit's power-supply cord to share an outlet with an unreasonable number of other devices. Be especially careful when using extension cords—the total power used by all devices you have connected to the extension cord's outlet must never exceed the power rating (watts/amperes) for the extension cord. Excessive loads can cause the insulation on the cord to heat up and eventually melt through.
- Before using the unit in a foreign country, consult with your retailer, the nearest Roland Service Center, or an authorized Roland distributor, as listed on the "Information" page.







WARNING

- Do not put anything that contains water (e.g., flower vases) on this unit. Also, avoid the use of insecticides, perfumes, alcohol, nail polish, spray cans, etc., near the unit. Swiftly wipe away any liquid that spills on the unit using a dry, soft cloth. 

CAUTION

- The unit should be located so that its location or position does not interfere with its proper ventilation. 
- Always grasp only the plug on the power-supply cord when plugging into, or unplugging from, an outlet or this unit. 
- At regular intervals, you should unplug the power plug and clean it by using a dry cloth to wipe all dust and other accumulations away from its prongs. Also, disconnect the power plug from the power outlet whenever the unit is to remain unused for an extended period of time. Any accumulation of dust between the power plug and the power outlet can result in poor insulation and lead to fire. 

CAUTION

- Try to prevent cords and cables from becoming entangled. Also, all cords and cables should be placed so they are out of the reach of children. 
- Never climb on top of, nor place heavy objects on the unit. 
- Never handle the power cord or its plugs with wet hands when plugging into, or unplugging from, an outlet or this unit. 
- Before moving the unit, disconnect the power plug from the outlet, and pull out all cords from external devices. 
- Before cleaning the unit, turn off the power and unplug the power cord from the outlet (p. 5). 
- Whenever you suspect the possibility of lightning in your area, pull the plug on the power cord out of the outlet. 
- The top of the unit may become hot, so take care to avoid burns. 



This product complies with the requirements of European Directives EMC 89/336/EEC and LVD 73/23/EEC.

For EU Countries

FEDERAL COMMUNICATIONS COMMISSION RADIO FREQUENCY INTERFERENCE STATEMENT

This equipment has been tested and found to comply with the limits for a Class B digital device, pursuant to Part 15 of the FCC Rules. These limits are designed to provide reasonable protection against harmful interference in a residential installation. This equipment generates, uses, and can radiate radio frequency energy and, if not installed and used in accordance with the instructions, may cause harmful interference to radio communications. However, there is no guarantee that interference will not occur in a particular installation. If this equipment does cause harmful interference to radio or television reception, which can be determined by turning the equipment off and on, the user is encouraged to try to correct the interference by one or more of the following measures:

- Reorient or relocate the receiving antenna.
- Increase the separation between the equipment and receiver.
- Connect the equipment into an outlet on a circuit different from that to which the receiver is connected.
- Consult the dealer or an experienced radio/TV technician for help.

This device complies with Part 15 of the FCC Rules. Operation is subject to the following two conditions:

- (1) This device may not cause harmful interference, and
- (2) This device must accept any interference received, including interference that may cause undesired operation.

Unauthorized changes or modification to this system can void the users authority to operate this equipment. This equipment requires shielded interface cables in order to meet FCC class B Limit.

For Canada

NOTICE

This Class B digital apparatus meets all requirements of the Canadian Interference-Causing Equipment Regulations.

AVIS

Cet appareil numérique de la classe B respecte toutes les exigences du Règlement sur le matériel brouilleur du Canada.

IMPORTANT NOTES

In addition to the items listed under “IMPORTANT SAFETY INSTRUCTIONS” and “USING THE UNIT SAFELY” on pages 2 ~ 4, please read and observe the following:

Power Supply

- Do not connect this unit to same electrical outlet that is being used by an electrical appliance that is controlled by an inverter (such as a refrigerator, washing machine, microwave oven, or air conditioner), or that contains a motor. Depending on the way in which the electrical appliance is used, power supply noise may cause this unit to malfunction or may produce audible noise. If it is not practical to use a separate electrical outlet, connect a power supply noise filter between this unit and the electrical outlet.
- Before connecting this unit to other devices, turn off the power to all units. This will help prevent malfunctions and/or damage to speakers or other devices.
- Although the LCD and LEDs are switched off when the POWER switch is switched off, this does not mean that the unit has been completely disconnected from the source of power. If you need to turn off the power completely, first turn off the POWER switch, then unplug the power cord from the power outlet. For this reason, the outlet into which you choose to connect the power cord’s plug should be one that is within easy reach and readily accessible.

Placement

- Using the unit near power amplifiers (or other equipment containing large power transformers) may induce hum. To alleviate the problem, change the orientation of this unit; or move it farther away from the source of interference.
- This device may interfere with radio and television reception. Do not use this device in the vicinity of such receivers.
- Noise may be produced if wireless communications devices, such as cell phones, are operated in the vicinity of this unit. Such noise could occur when receiving or initiating a call, or while conversing. Should you experience such problems, you should relocate such wireless devices so they are at a greater distance from this unit, or switch them off.
- Do not expose the unit to direct sunlight, place it near devices that radiate heat, leave it inside an enclosed vehicle, or otherwise subject it to temperature extremes. Also, do not allow lighting devices that normally are used while their light source is very close to the unit (such as a piano light), or powerful spotlights to shine upon the same area of the unit for extended periods of time. Excessive heat can deform or discolor the unit.
- When moved from one location to another where the temperature and/or humidity is very different, water droplets (condensation) may form inside the unit. Damage or malfunction may result if you attempt to use the unit in this condition. Therefore, before using the unit, you must allow it to stand for several hours, until the condensation has completely evaporated.
- Do not allow rubber, vinyl, or similar materials to remain on the unit for long periods of time. Such objects can discolor or otherwise harmfully affect the finish.

- Do not paste stickers, decals, or the like to this instrument. Peeling such matter off the instrument may damage the exterior finish.

Maintenance

- For everyday cleaning wipe the unit with a soft, dry cloth or one that has been slightly dampened with water. To remove stubborn dirt, use a cloth impregnated with a mild, non-abrasive detergent. Afterwards, be sure to wipe the unit thoroughly with a soft, dry cloth.
- Never use benzene, thinners, alcohol or solvents of any kind, to avoid the possibility of discoloration and/or deformation.

Additional Precautions

- Use a reasonable amount of care when using the unit’s buttons, sliders, or other controls; and when using its jacks and connectors. Rough handling can lead to malfunctions.
- When connecting / disconnecting all cables, grasp the connector itself—never pull on the cable. This way you will avoid causing shorts, or damage to the cable’s internal elements.
- A small amount of heat will radiate from the unit during normal operation.
- To avoid disturbing your neighbors, try to keep the unit’s volume at reasonable levels (especially when it is late at night).
- When you need to transport the unit, package it in the box (including padding) that it came in, if possible. Otherwise, you will need to use equivalent packaging materials.
- Use a cable from Roland to make the connection. If using some other make of connection cable, please note the following precautions.
 - Some connection cables contain resistors. Do not use cables that incorporate resistors for connecting to this unit. The use of such cables can cause the sound level to be extremely low, or impossible to hear. For information on cable specifications, contact the manufacturer of the cable.
- Avoid inserting fingers into the bass reflex ducts when transporting or handling the unit. Otherwise, you risk getting your fingers stuck.



Panel Descriptions

Front

Power Switch

This switch turns the power on/off.



If you need turn off the power supply completely, first turn off the POWER switch, then unplug the power cord from the power outlet. Refer to **Power Supply** (p. 5).

HF Driver

* Do not touch the diaphragm.

LF Driver

* Do not touch the speaker cone.



Bass-reflex Ducts

These are conduits for rich, bass-range reproduction.

Digital In Indicator

This lights up when output is received from a connected digital device.

Connect the digital-signal output device, set the "Input Select switch" to DIGITAL INPUT, and set the "Digital Input select switch" according to the connector to which the device is attached (Coaxial, Optical or XLR (AES/EBU)).

* When the connected digital-signal output device is not powered up, the Digital In indicator does not light up.

Power Indicator

Lights when power is on.



Before turning the power on or off, you must lower the volume of this unit and your connected device etc. This unit is equipped with a protection circuit. A brief interval (a few seconds) after power up is required before the unit will operate normally.

Rear

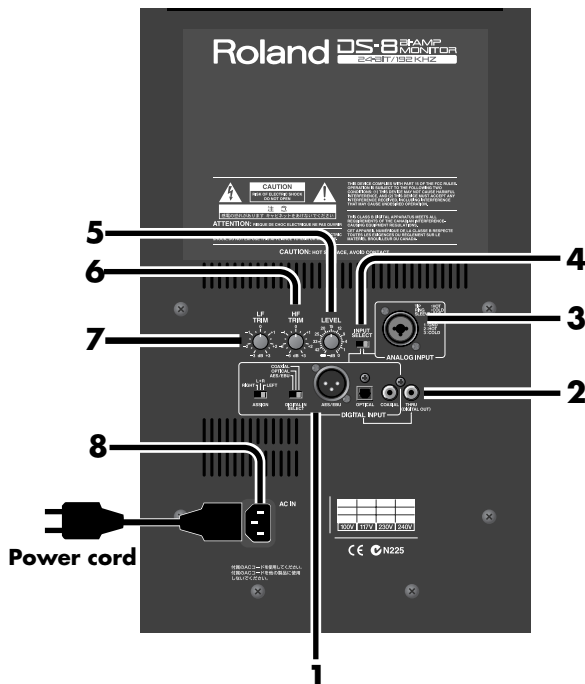

1 Digital Input

Coaxial Input Connector (Digital Input)

This is the digital input connector for coaxial cable.



It cannot be used for input of analog audio signals (no sound is produced).

Optical Input Connector (Digital Input)

This is the digital input connector for optic-fiber cable. Use commercially available optical cable for audio equipment to make the connection.

XLR Input Connector (Digital Input)

This is a digital input for AES/EBU professional format digital audio.



It cannot be used for input of analog audio signals (no sound is produced).

Digital Input Select Switch

This switch selects AES/EBU, Optical or Coaxial. Select the connector used for the input signal.

Assign Switch

This switch selects the stereo position of the digital signal. It selects Right, L+R, or Left when using two DS-8/7/5 monitors for stereo sound (with digital signals). Choose the setting appropriate for your setup.

MEMO

With the DS-8/7/5, there is no difference between L and R. When using the digital input connectors of two DS-8/7/5 monitors for stereo sound, the digital signal can be input to either L or R.

2 Thru (Digital Out) Connector

When connecting multiple DS-8/7/5 monitors with digital signals, this connector is used for output to the second DS-8/7/5.

HINT

Refer to **Connection Examples** (p. 8).

3 Analog Input

XLR/TRS Phone Input Connector (Analog Input)

This is for connecting XLR or TRS phone plugs.

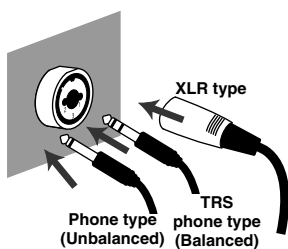

Both balanced and unbalanced connections are possible.

This instrument is equipped with balanced (XLR/TRS) type input jacks. Wiring diagrams for these jacks are shown below. Make connections after first checking the wiring diagrams of other equipment you intend to connect.

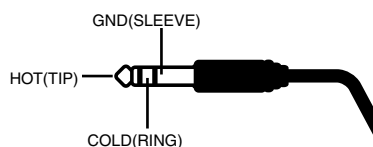

4 Input Select Switch

Used to select Digital Input or Analog Input. Select the connector used for the input signal.

5 Level Control

This adjusts the input level. Turning the control clockwise increases the sound from the speakers.

6 HF Trim Control

This adjusts the sound quality of the treble range. It adjusts the output level of the HF driver. (+/-3 dB above the crossover frequency)

7 LF Trim Control

This adjusts the sound quality of the bass range (80 Hz, +/-3 dB).

MEMO

The LF Trim and HF Trim controls on the DS-8/7/5 are designed to correct the sound quality of the sonic field. Use these to make fine adjustments to match the usage conditions.

8 AC Inlet

Connect the included Power cord here. Plug it firmly in, so that the cable does not accidentally become disconnected.

Connection Examples

Using Two DS-8/7/5 Monitors for Stereo Sound

Example for Using Analog Input Connectors

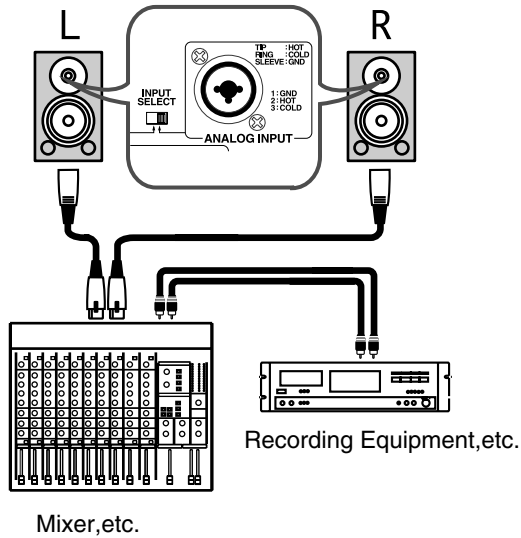

Example for Using Digital Input Connectors

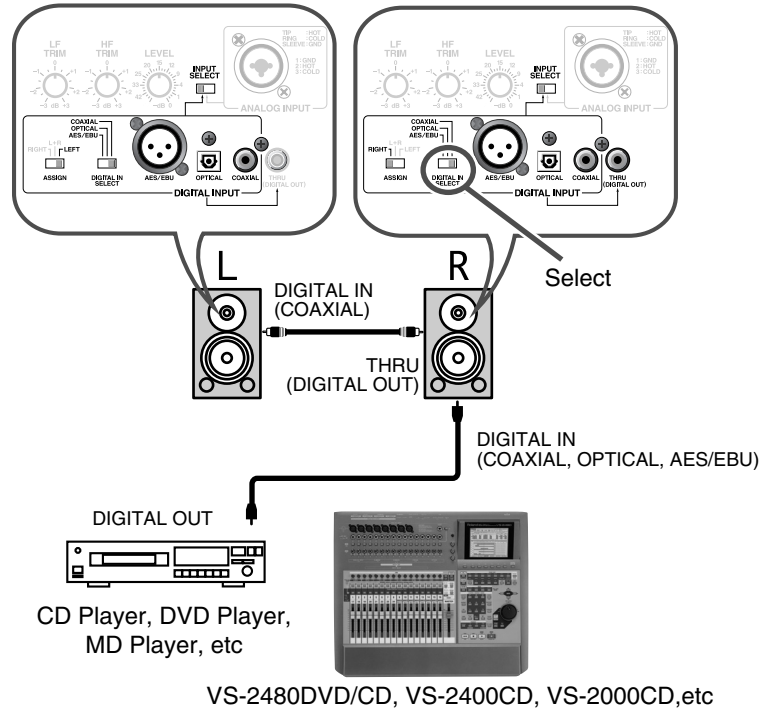

Tips about high sound quality playback

- Please pay careful attention to the placement location. In order to take full advantage of the low-frequency playback capabilities of this device, we recommend that you place it on a hard and strong base.
- When using digital in connections, turn down the LEVEL knob of this device and raise the output level of the connected device. This will take advantage of the full number of bits in the digital signal, improving the audio quality.

Important Notes on Placement

- During setup and transport, be careful not to damage the vibrating portions (the speaker cone and diaphragm).
- Be sure to place the monitor so that the slits on the top to radiate the heat is not obstructed. Also, make sure the monitor does not touch any curtains or other fabrics.
- This unit performs cooling when the monitor is placed as shown below. Do not place the monitor on its side or upside down.

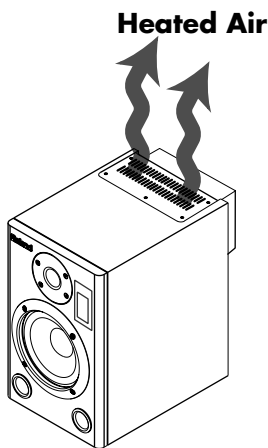

- When this unit is in operation, the top side will become hot. Take care not to touch it.
- Do not put anything on the unit.
- During operation, this unit must be placed at a distance of no less than 20 cm (7-7/8 inches) from any walls.

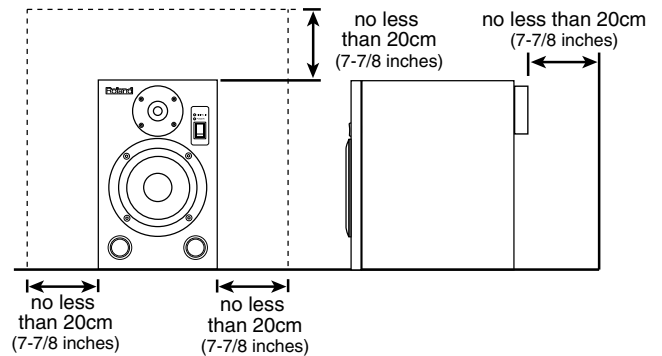

* Please also refer to "Placement" in **IMPORTANT NOTES** (p. 5).

Precautions When Connecting and Turning on the Power

- To prevent malfunction and/or damage to speakers or other devices, always turn down the volume, and turn off the power on all devices before making any connections.
- Once the connections have been completed, turn on power to your various devices in the order specified. By turning on devices in the wrong order, you risk causing malfunction and/or damage to speakers and other devices. (When turning the power off, reverse this procedure.)
 1. Turn on the power on the devices connected to the DS-8/7/5.
 2. Turn off the power on the DS-8/7/5.
- This unit is equipped with a protection circuit. A brief interval (a few seconds) after power up is required before the unit will operate normally.
- When connection cables with resistors are used, the volume level of equipment connected to the inputs (Analog Input) may be low. If this happens, use connection cables that do not contain resistors, such as those from the Roland PCS series.

Reference

Troubleshooting

If there is no sound or if the unit does not operate as you expect, please check the following points first. If this does not resolve the problem, contact the nearest Roland service center or authorized Roland distributor.

There's No Sound

- Make sure the Input Level control has not been turned fully counterclockwise.
- Make sure the Input Select switch has been set to the connector where the input signal is connected (Digital Input or Analog Input).
- Make sure the Digital Input select switch has been set to the connector where the input signal is connected (AES/EBU, Optical or Coaxial).
- Input a digital signal to the Digital Input connector. No sound is produced when an analog signal is input.

The volume level of the instrument connected to ANALOG INPUT is too low

- Could you be using a connection cable that contains a resistor? Use a connection cable that does not contain a resistor.

During Digital Signal Input, the Stereo Image Is Reversed or Sounds Unnatural, or Output Doesn't Sound Like Stereo

- Check the setting of the Assign switch (Right, L+R, or Left). The DS-8/7/5 uses an identical construction for the left and right monitors, and makes no distinction between left and right. During digital signal input, set the Assign switch L or R as appropriate for your setup.

Dimensions

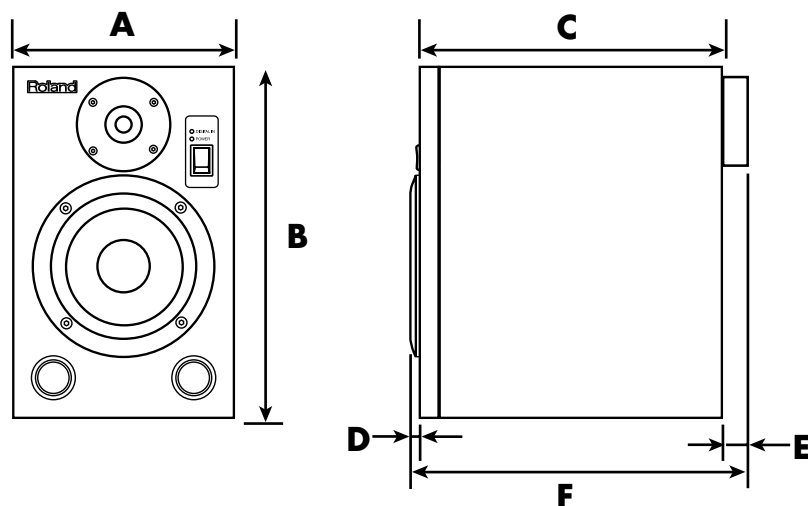

* Not include the power cord.

	DS-8	DS-7	DS-5
A	254 mm (10 inches)	209 mm (8-1/4 inches)	184 mm (7-1/4 inches)
B	406 mm (16 inches)	336 mm (13-1/4 inches)	295 mm (11-5/8 inches)
C	317.5 mm (12-1/2 inches)	262 mm (10-3/8 inches)	228.6 mm (9 inches)
D	7.5 mm (5/16 inches)	7.5 mm (5/16 inches)	7 mm (5/16 inches)
E	42 mm (1-11/16 inches)	37 mm (1-1/2 inches)	32 mm (1-5/16 inches)
F	367 mm (14-1/2 inches)	306.5 mm (12-1/8 inches)	267.6 mm (10-9/16 inches)

Frequency Response

DS-8

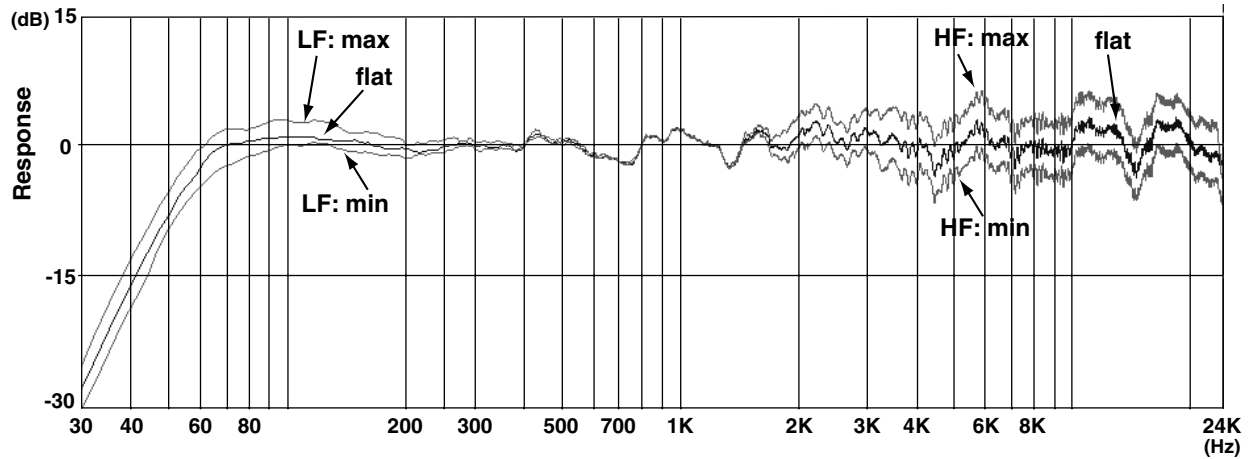

DS-7

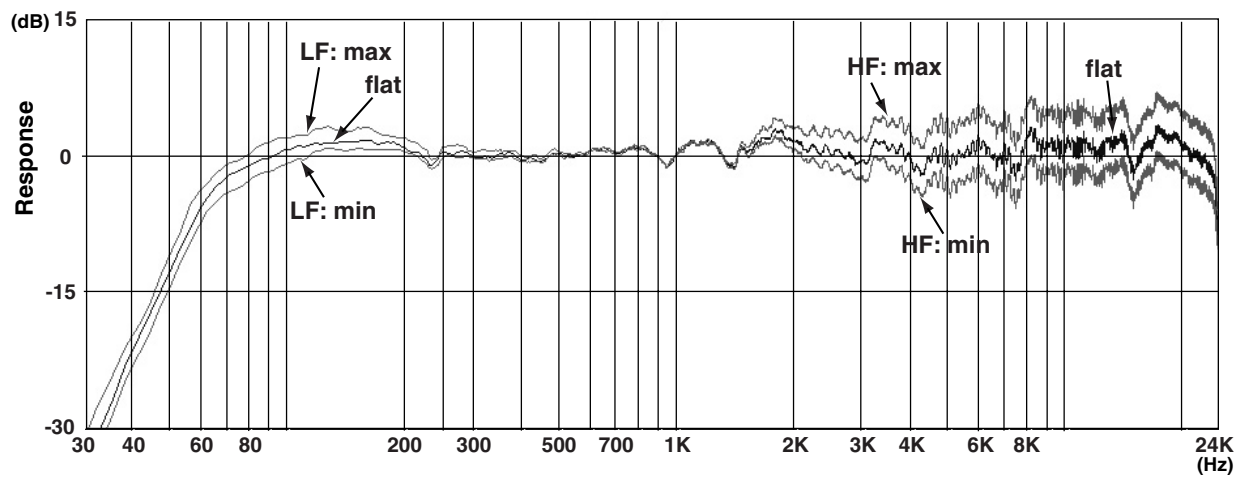

DS-5

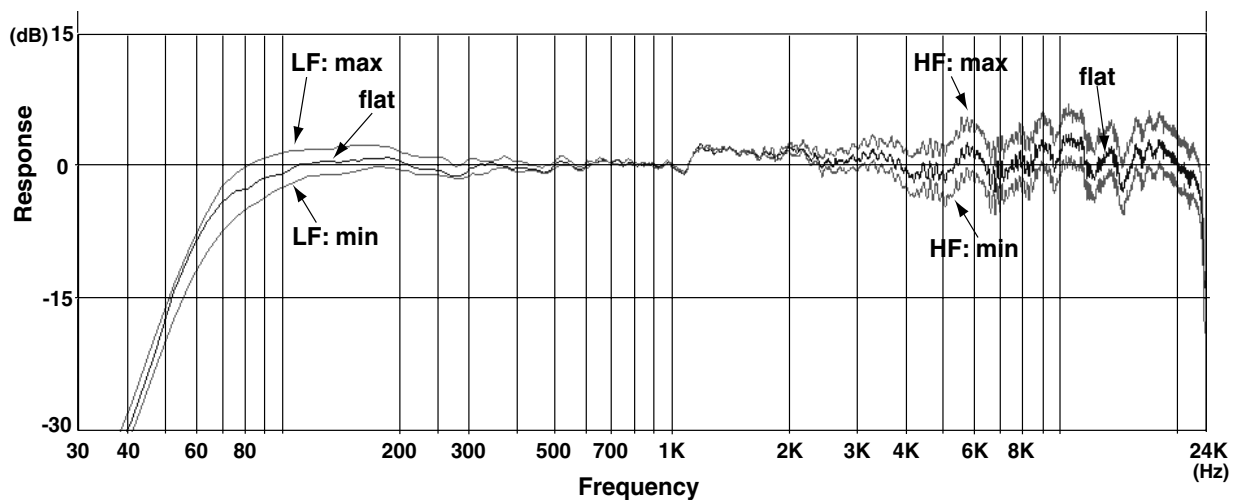

Specifications

	DS-8	DS-7	DS-5
System	2-Way Bi-Amplified Monitor		
Enclosure	Bass-reflex type		
Cabinet	3/4" MDF (Baffle: 1" MDF)	5/8" MDF (Baffle: 3/4" MDF)	1/2" MDF (Baffle: 5/8" MDF)
LF Driver	200 mm (8") Polypropylene cone type, magnetically shielded	160 mm (6-1/2") Polypropylene cone type, magnetically shielded	130 mm (5-1/4") Polypropylene cone type, magnetically shielded
HF Driver	25 mm (1") Soft dome type, magnetically shielded	19 mm (3/4") Soft dome type, magnetically shielded	19 mm (3/4") Soft dome type, magnetically shielded
Frequency Response	58 Hz to 24 kHz (+/-3 dB)	68 Hz to 23 kHz (+/-3 dB)	78 Hz to 23 kHz (+/-3 dB)
Crossover Frequency	2.3 kHz (active fourth order)	2.7 kHz (active fourth order)	3.3 kHz (active fourth order)
LF Amplifier Power	80 W	40 W	30 W
HF Amplifier Power	40 W	20 W	15 W
Analog In Input Sensitivity	0 dBu (0.775 Vrms)		
Input Impedance	20 k ohms (Balanced/Unbalanced)		
Digital In Format	Conformity with AES/EBU and IEC60958		
Sample Rate	32 kHz to 192 kHz (automatically) (de-emphasis: OFF)		
Word Length	24 bit		
DA Converter	24 bit		
Controls	LEVEL Knob, LF TRIM Knob, HF TRIM Knob INPUT SELECT SW (Analog In/Digital In) ASSIGN SW (Right/L+R/Left) DIGITAL INPUT SELECT SW (AES/EBU / Optical / Coaxial) POWER SW		
Indicators	POWER, DIGITAL IN		
Connectors	ANALOG INPUT (XLR, 1/4 inch TRS phone type) DIGITAL INPUT (XLR, Optical, Coaxial) DIGITAL THRU OUT (Coaxial)		
Power Supply	AC 117 V, AC 220 V, AC 230 V, AC 240 V (50/60 Hz)		
Power Consumption	125 W	75 W	55 W
Dimensions	254 (W) x 367 (D) x 406 (H) mm 10 (W) x 14-1/2 (D) x 16 (H) inches	209 (W) x 306.5 (D) x 336 (H) mm 8-1/4 (W) x 12-1/8 (D) x 13-1/4 (H) inches	184 (W) x 267.6 (D) x 295 (H) mm 7-1/4 (W) x 10-9/16 (D) x 11-5/8 (H) inches
Weight	17.2 kg / 37 lbs 15 oz	9.7 kg / 21 lbs 7 oz	7.2 kg / 15 lbs 14 oz
Accessories	Owner's Manual, Power Cord		

* In the interest of product improvement, the specifications and/or appearance of this unit are subject to change without prior notice.

For EU Countries



UK This symbol indicates that in EU countries, this product must be collected separately from household waste, as defined in each region. Products bearing this symbol must not be discarded together with household waste.

DE Dieses Symbol bedeutet, dass dieses Produkt in EU-Ländern getrennt vom Hausmüll gesammelt werden muss gemäß den regionalen Bestimmungen. Mit diesem Symbol gekennzeichnete Produkte dürfen nicht zusammen mit dem Hausmüll entsorgt werden.

FR Ce symbole indique que dans les pays de l'Union européenne, ce produit doit être collecté séparément des ordures ménagères selon les directives en vigueur dans chacun de ces pays. Les produits portant ce symbole ne doivent pas être mis au rebut avec les ordures ménagères.

IT Questo simbolo indica che nei paesi della Comunità europea questo prodotto deve essere smaltito separatamente dai normali rifiuti domestici, secondo la legislazione in vigore in ciascun paese. I prodotti che riportano questo simbolo non devono essere smaltiti insieme ai rifiuti domestici. Ai sensi dell'art. 13 del D.Lgs. 25 luglio 2005 n. 151.

ES Este símbolo indica que en los países de la Unión Europea este producto debe recogerse aparte de los residuos domésticos, tal como está regulado en cada zona. Los productos con este símbolo no se deben depositar con los residuos domésticos.

PT Este símbolo indica que nos países da UE, a recolha deste produto deverá ser feita separadamente do lixo doméstico, de acordo com os regulamentos de cada região. Os produtos que apresentem este símbolo não deverão ser eliminados juntamente com o lixo doméstico.

NL Dit symbool geeft aan dat in landen van de EU dit product gescheiden van huishoudelijk afval moet worden aangeboden, zoals bepaald per gemeente of regio. Producten die van dit symbool zijn voorzien, mogen niet samen met huishoudelijk afval worden verwijderd.

DK Dette symbol angiver, at i EU-lande skal dette produkt opsamlles adskilt fra husholdningsaffald, som defineret i hver enkelt region. Produkter med dette symbol må ikke smides ud sammen med husholdningsaffald.

NO Dette symbolet indikerer at produktet må behandles som spesialavfall i EU-land, iht. til retningslinjer for den enkelte regionen, og ikke kastes sammen med vanlig husholdningsavfall. Produkter som er merket med dette symbolet, må ikke kastes sammen med vanlig husholdningsavfall.

SE Symbolen anger att i EU-länder måste den här produkten kasseras separat från hushållsavfall, i enlighet med varje regions bestämmelser. Produkter med den här symbolen får inte kasseras tillsammans med hushållsavfall.

FI Tämä merkintä ilmaisee, että tuote on EU-maissa kerättävä erillään kotitalousjätteistä kunkin alueen voimassa olevien määräysten mukaisesti. Tällä merkinnällä varustettuja tuotteita ei saa hävittää kotitalousjätteiden mukana.

HU Ez a szimbólum azt jelenti, hogy az Európai Unióban ezt a terméket a háztartási hulladéktól elkülönítve, az adott régióban érvényes szabályozás szerint kell gyűjteni. Az ezzel a szimbóllumal ellátott termékeket nem szabad a háztartási hulladék közé dobni.

PL Symbol oznacza, że zgodnie z regulacjami w odpowiednim regionie, w krajach UE produktu nie należy wyrzucać z odpadami domowymi. Produktów opatrzonych tym symbolem nie można utylizować razem z odpadami domowymi.

CZ Tento symbol udává, že v zemích EU musí být tento výrobek sbírán odděleně od domácího odpadu, jak je určeno pro každý region. Výrobky nesoucí tento symbol se nesmí vyhadzovat spolu s domácím odpadem.

SK Tento symbol vyjadruje, že v krajinách EÚ sa musí zber tohto produktu vykonávať oddelene od domového odpadu, podľa nariadení platných v konkrétnej krajine. Produkty s týmto symbolom sa nesmú vyhadzovať spolu s domovým odpadom.

EE See sümbol näitab, et EL-i maades tuleb see toode olmeprügist eraldi koguda, nii nagu on igas piirkonnas määratletud. Selle sümboliga märgitud tooteid ei tohi ära visata koos olmeprügiga.

LT Šis simbolis rodo, kad ES šalyse šis produktas turi būti surenkamas atskirai nuo buitinių atliekų, kaip nustatyta kiekviename regione. Šiuo simboliu paženklinyti produktai neturi būti išmetami kartu su buitiniemis atliekomis.

LV Šis simbols norāda, ka ES valstīs šo produktu jāievāc atsevišķi no mājsaimniecības atkritumiem, kā noteikts katrā reģionā. Produktus ar šo simbolu nedrīkst izmest kopā ar mājsaimniecības atkritumiem.

SI Ta simbol označuje, da je treba proizvod v državah EU zbirati ločeno od gospodinjjskih odpadkov, tako kot je določeno v vsaki regiji. Proizvoda s tem znakom ni dovoljeno odlagati skupaj z gospodinjjskimi odpadki.

GR Бхф фп уэмвпш дзлюней бфп уфйт чюсет фэт ЕЕ, фп рспьнх бхф рсЭрей нб ухллЭгэфбй оечсйуфь брь фб пйкйбкь брпсЯммбфб, уэмцнб ме фб нмппеуЯб фэт фые респчЮт. Фб рспьнфб рпх цЭспхн бхф фп уэмвпш ден рсЭрей нб брпсЯрфпнфбй мбжЯ ме фб пйкйбкь брпсЯммбфб.

Free Manuals Download Website

<http://myh66.com>

<http://usermanuals.us>

<http://www.somanuals.com>

<http://www.4manuals.cc>

<http://www.manual-lib.com>

<http://www.404manual.com>

<http://www.luxmanual.com>

<http://aubethermostatmanual.com>

Golf course search by state

<http://golfingnear.com>

Email search by domain

<http://emailbydomain.com>

Auto manuals search

<http://auto.somanuals.com>

TV manuals search

<http://tv.somanuals.com>