

# DR-55 SERVICE NOTES

## SPECIFICATIONS

OUTPUT DBS : +5 V (8 ms) CSQ : +4 V (10 ms)  
 VOICE : (at OUTPUT Jack, Power source 6 V)  
 VOLUME, TONE : at max. ACCENT : at min.

	Amplitude (Vpp)			Frequency (Hz)			Decay (ms)		
	min.	avr.	max.	min.	avr.	max.	min.	avr.	max.
BD	1.0	1.3	1.6	14	62 (16 ms)	18			
RS	0.7	0.9	1.2	0.65	0.75 (1330 ms)	0.85	5	7	10
SD (noise)	0.3	0.4 1.2	0.6	2.7	3.1 (320 ms)	3.5	55	75	100
HH		1.2					35	50	70

POWER REQUIREMENTS -- 4.5 V-6.5 V. (Current draw 5.5 mA @6 V)  
 DIMENSIONS ----- 211 (W) x 116 (D) x 53 (H) mm  
 WEIGHT ----- 850 g

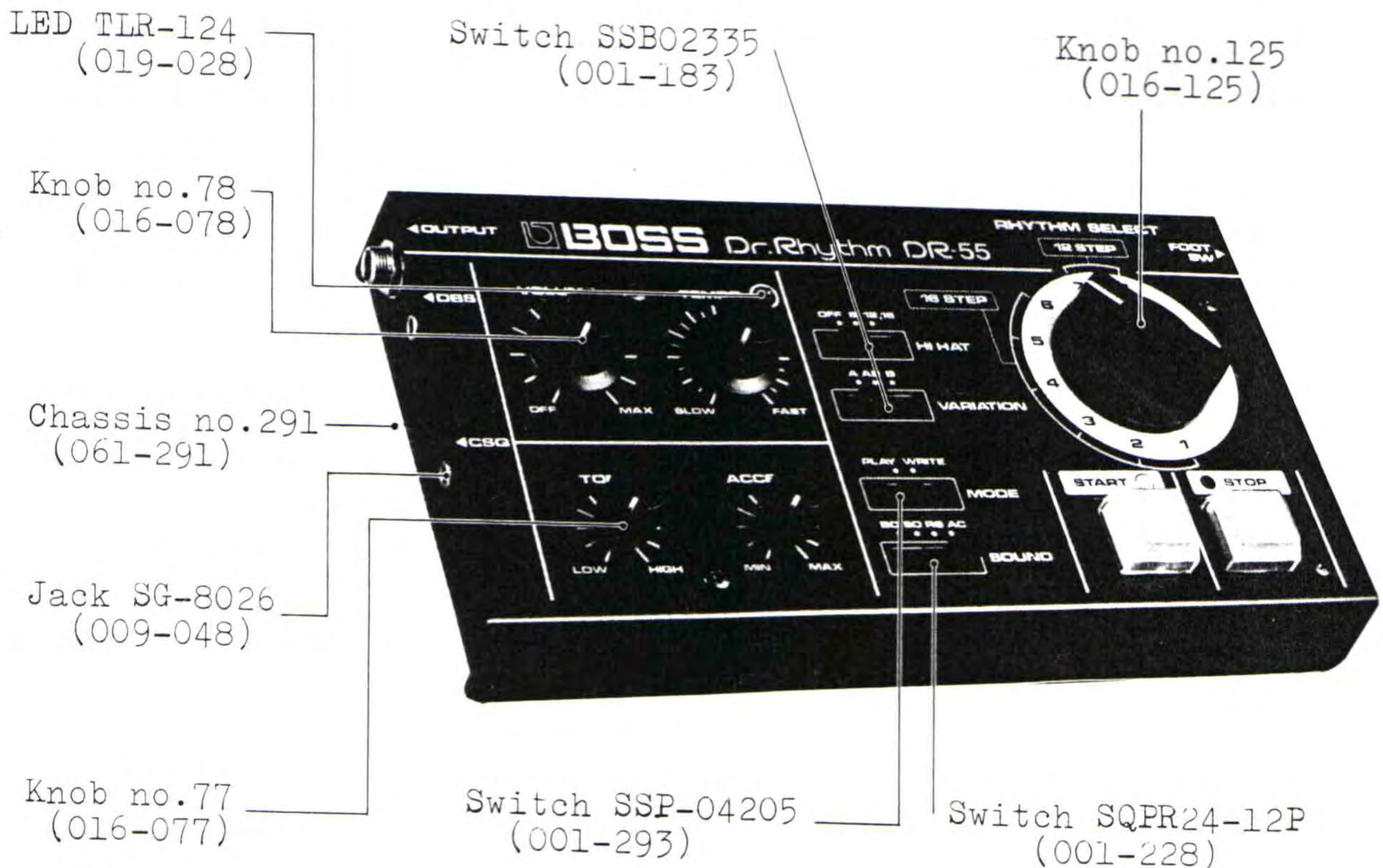

\* For the START and STOP switches, refer to the Parts List



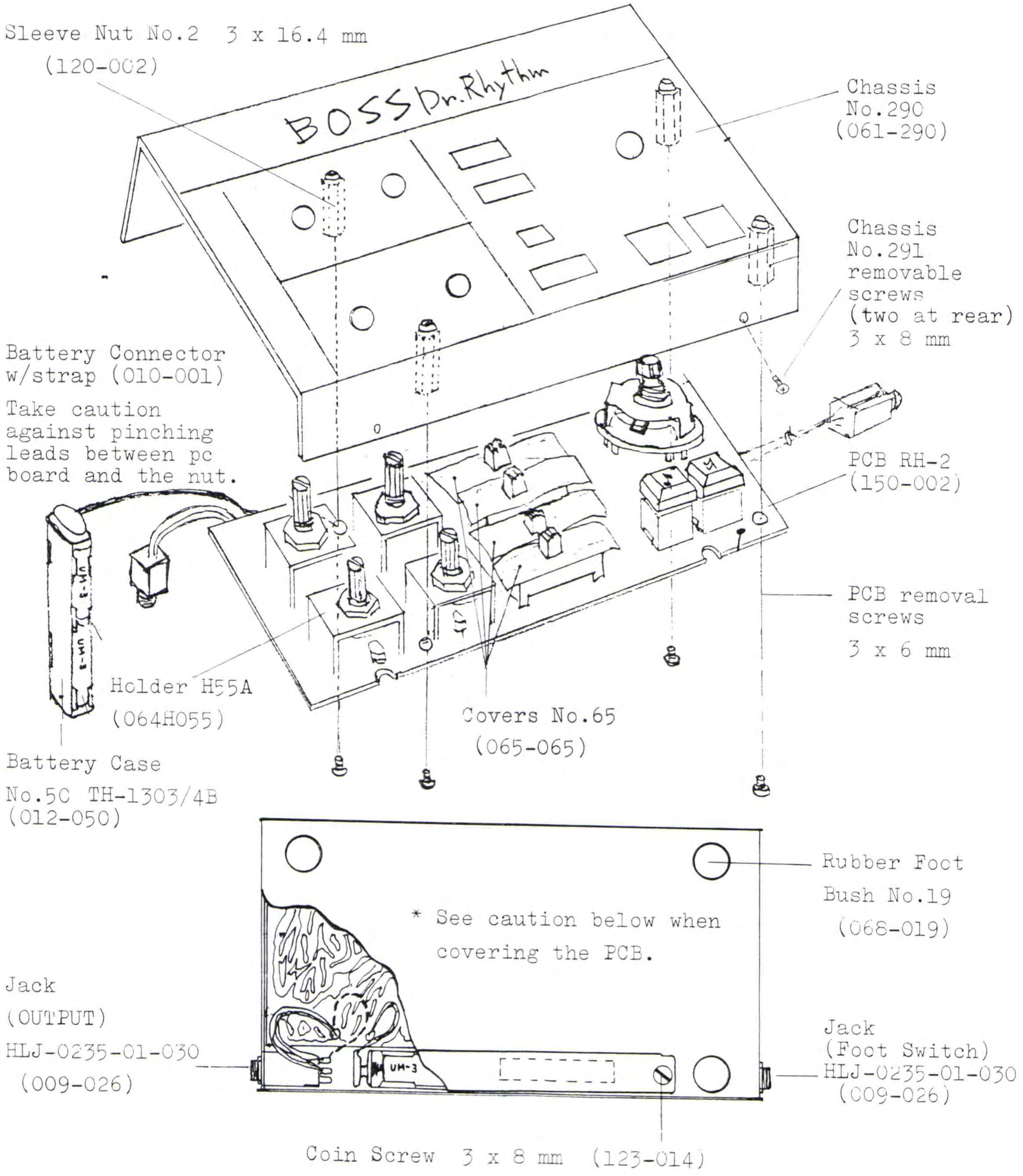

\* CAUTION: Do not lay jack leads over the PCB as shown in dotted line. Since high gain stage is located on that area, the leads will provide feedback loop.



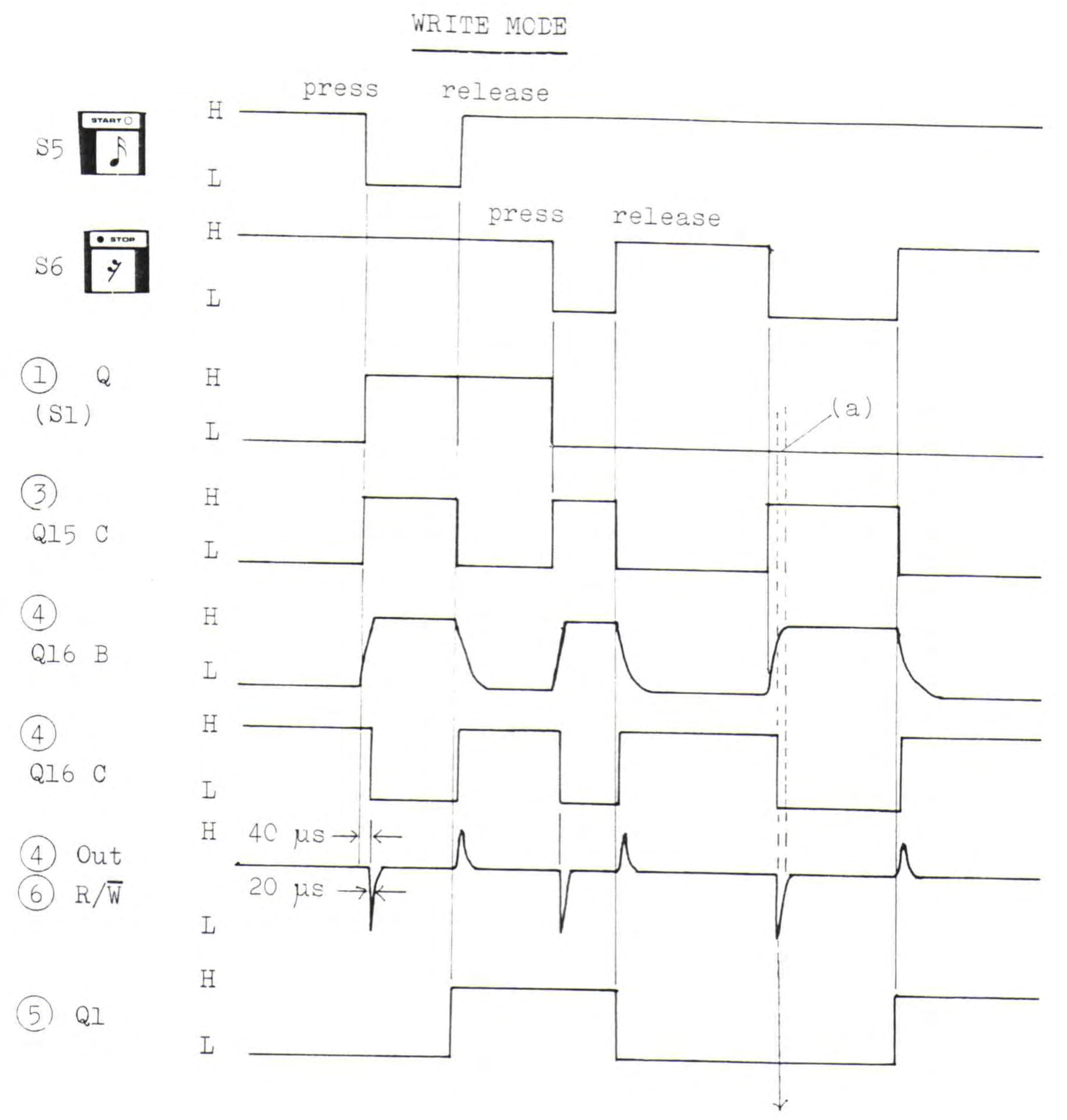
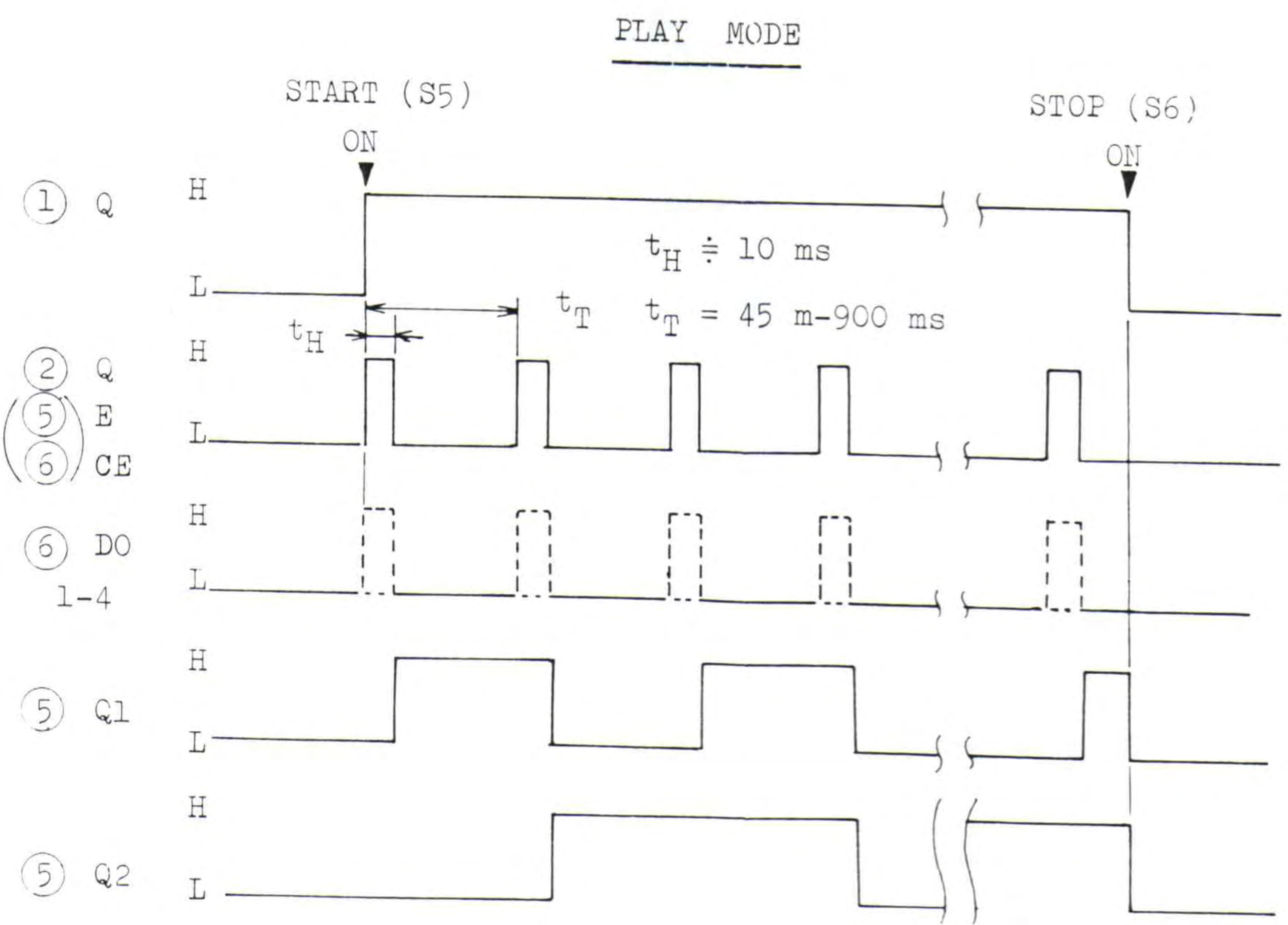
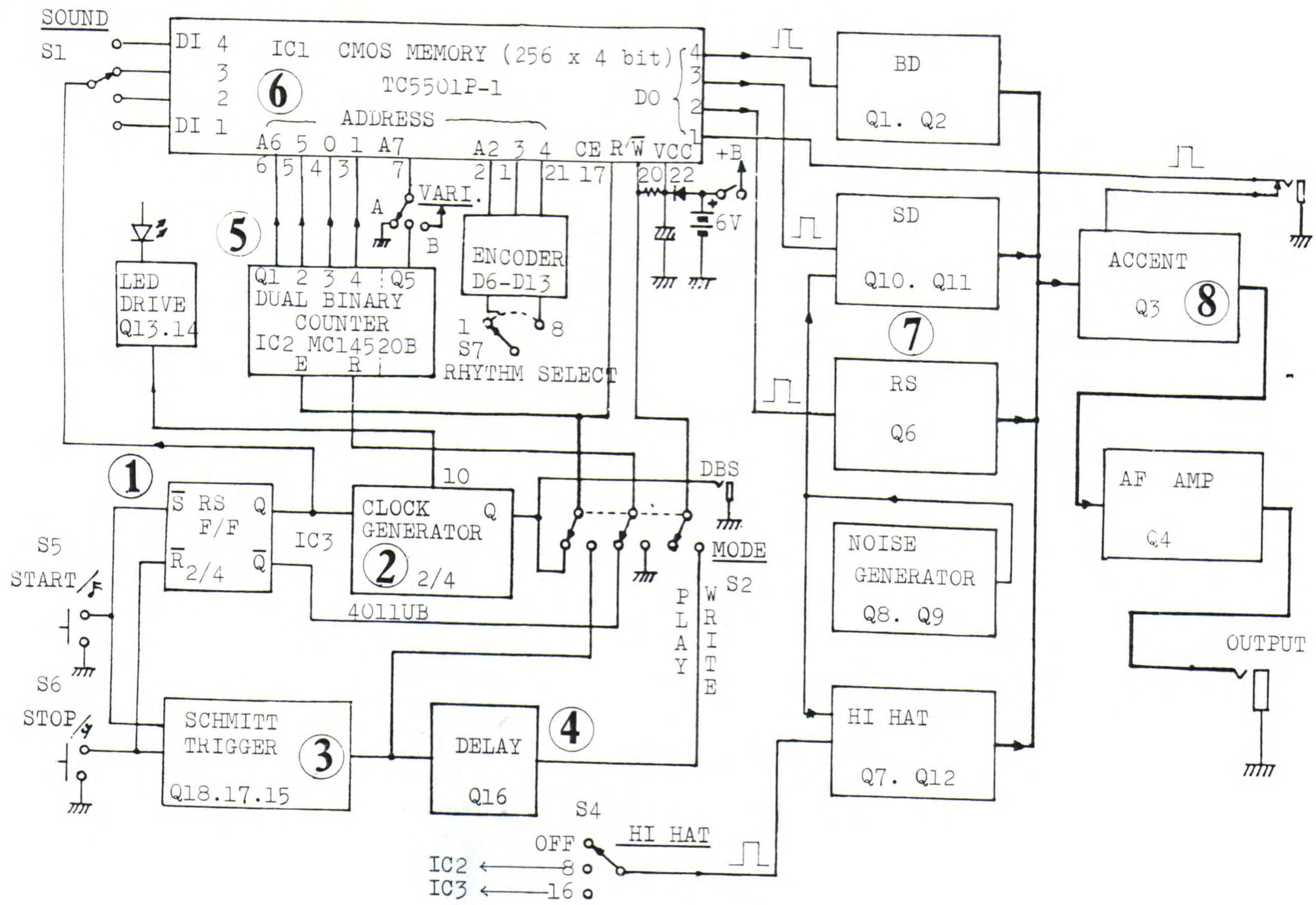

Data (a) is written during this time.

**CIRCUIT DESCRIPTION**

The heading numbers of this circuit description correspond to those in the block diagram above.



FEB. 21,1980

1 RS FLIP FLOP (2/4 IC3)

(a) PLAY Mode

When the START switch S5 is turned ON, the Q output goes to H and triggers the Clock Generator (2). When the STOP switch S6 is turned ON, the Q output goes to L and the Clock Generator stops oscillation. At this time, the Q output goes to H and resets the Binary Counter (5)

(b) WRITE Mode

The Q output goes to H when S5 is turned ON, and goes to L when S6 is turned ON. This condition is written in the Memory IC1 as a data.

2 CLOCK GENERATOR (2/4 IC3)

The frequency of this oscillator is controlled with TEMPO VR-5. This oscillator functions in PLAY mode only, and feeds clock pulses to the Counter (5)

3 SCHMITT TRIGGER (Q15, 17, 18)

This circuit functions in WRITE mode only. The collector of Q15 goes H when either the START switch S5 or the STOP switch S6 is turned ON, and goes to L when the switch set to ON is turned OFF.

4 DELAY CIRCUIT (Q16)

The output from the Schmitt circuit (3) is intergrated, and fed to the base of Q16. Then the signal is trimmed to square wave at collector of Q16. This output signal is differentiated and becomes pulses, and then is applied to the R/~W terminal of IC1. The two pulses lag a little behind edges of Scmitt (3) output pulse.

5 DUAL BINARY COUNTER (IC2)

This circuit counts pulses from the clock generator (2) in PLAY mode, and counts pulses from the Schmitt trigger (3) in WRITE mode, and then outputs binary-coded signals from the terminals Q1-Q5; Q1-Q4 denote 16 steps composing each rhythm. Signal from Q5 is applied to A7 only when the VARIATION switch is set to AB.

To the terminal A7, the L level voltage is given when the switch is set to A and H when switch is set to B.

## 6 256 x 4 BIT CMOS MEMORY (IC1)

Reading/writing from/to this memory is as described below. The upper 3 bits designate rhythms 1-8, the next one bit designates VARIATION A and B, and the lower 4 bits 16 steps in one rhythm. In PLAY mode, the terminal CE2 is connected to the Clock generator output. The memory functions only when the clock is H, and outputs H's or L's from DO 1-4. (When the clock is L, DO 1-4 becomes high impedance.)

In WRITE mode, when the terminal R/~W becomes L, a data from the flip flop is written in one of DI 1-4 via S1. A previously stored data is rewritten from DO via R61-R64 to the remaining three DI's.

The Vcc of this memory chip is directly connected to the dry cells regardless of power switch positions, since the chip draws only a very slight idling current during stand-by. As a result, the data is guaranteed to be stored as long as the dry cells maintain voltage value higher than a specified level. The capacitor C39 (22 mfd.) connected to the terminal Vcc can substitute for the dry cells by its charge for several minutes when the cells are absent during replacement.

## 7 VOICE GENERATOR (Q1, 2, 3, 7, 8, 9, 10, 11)

BD, SD and RS are triggered by pulses from the respective DO's. HI HAT is triggered by pulses from the counter IC2 or the Clock generator IC3 by every step or every other step.

## 8 ACCENT (Q3)

Each sound source output is mixed and outputted through the resistor network in which Q3 is connected in parallel. When ACCENT pulse is outputted from DO 1, Q3 turned ON, and in this ON period the signal amplitude increases. The DO 1 pulse can be externally outputted through the CSQ jack. When this jack is engaged,

however, the  
ACCENT function of the DR-55 proper becomes invalid.





VR5, VR6, 2SK30A-Y  
Serial number up to 912800.

R77, R100:  
on foil side

Serial number up to 923500  
 IC3 -- CD4011UB only  
 VR-3 -- 500KC  
 C42 -- 1mfd N.P.  
 R79 -- 6.8K  
 R81 -- 22K

with 923600  
 IC3 -- TC4011UBP or CD4011UB  
 VR-3 -- 1MC  
 C42 -- 0.47mfd N.P.  
 R79 -- 15K  
 R81 -- 47K

Q13-17 : 2SC945- P or Q



## PARTS LIST

061-290 Chassis no.290 (panel)  
 061-291 Chassis no.291  
 061-292 Chassis no.292(battery compartment lid)  
 111-019 Bush no.19 (rubber foot)

016-077 Knob no.77 TONE, ACCENT  
 016-078 Knob no.78 VOLUME, TEMPO  
 016-125 Knob no.125 RHYTHM SELECT

009-026 Jack HLJ-0235-01-030 1/4"  
 009-048 Jack SG-8026 mini. DBS, CSQ

## PCB

150-002 RH-2 (PCB 052-537)

## SWITCH

001-183 SSB02335 slide HI HAT, VARIATION  
 001-228 SQPR24-12P slide SOUND  
 001-293 SSP-04205 rotary RHYTHM SELECT  
 001-299-1 KED-10903-1 START assy w/key top,  
 001-299-2 KED-10903-2 STOP cap and mark

\*Cap and mark are available separately.

## POTENTIOMETER

028-755 VM10RC38C 1MA VR1 TONE  
 028-372 VM11R5M1411 10KA w/sw VR2 VOLUME  
 028-776 VM10RC38C 500KC VR4 ACCENT  
 VR3 TEMPO--S/N up to 923500

028-777 VM10RC38C 1MC VR3 with S/N 923600

030-519 EVNK4AA00B13 1K trimmer  
 030-522 EVNK4AA00B54 50K  
 030-521 EVNK4AA00B14 10K S/N up to 912800

## SEMICONDUCTOR

017-023 2SC945-P transistor  
 017-091 2SK30A -0 or -Y see circuit dia.FET  
 017-024 2SA733-P transistor  
 018-014 1S2473 or equiv. diode  
 019-028 TLR-124 red LED  
 020-030 TC-5501P-1 1024-bit CMOS RAM  
 020-081 CD-4011UBE or TC4011UBP  
 refer to circuit diagram  
 020-166 MC-14520P dual binary up counter

## OTHERS

022-030 Choke coil no.30 45mH  
 120-002 Sleeve nut no.2 3 x 16.4 mm  
 064H55A Holder H55A potentiometer  
 012-050 Battery case TH-1303/4B  
 010-001 Battery connector w/strap  
 123-014 Screw 3x8mm battery compartment lid  
 107-050 Cushion no.59 battery  
 Cover (felt strip) slide switch

## RH-2(150-002) (PCB 052-537)

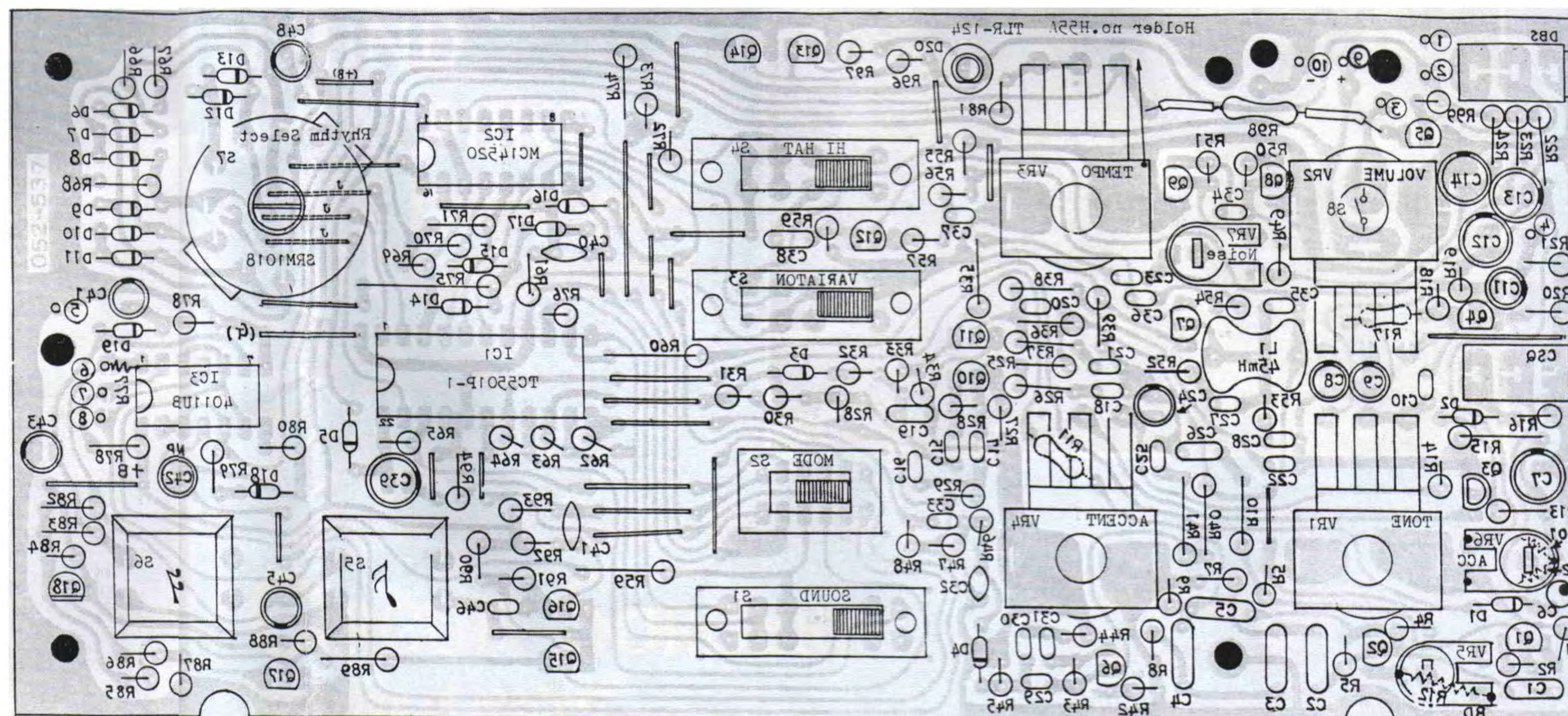
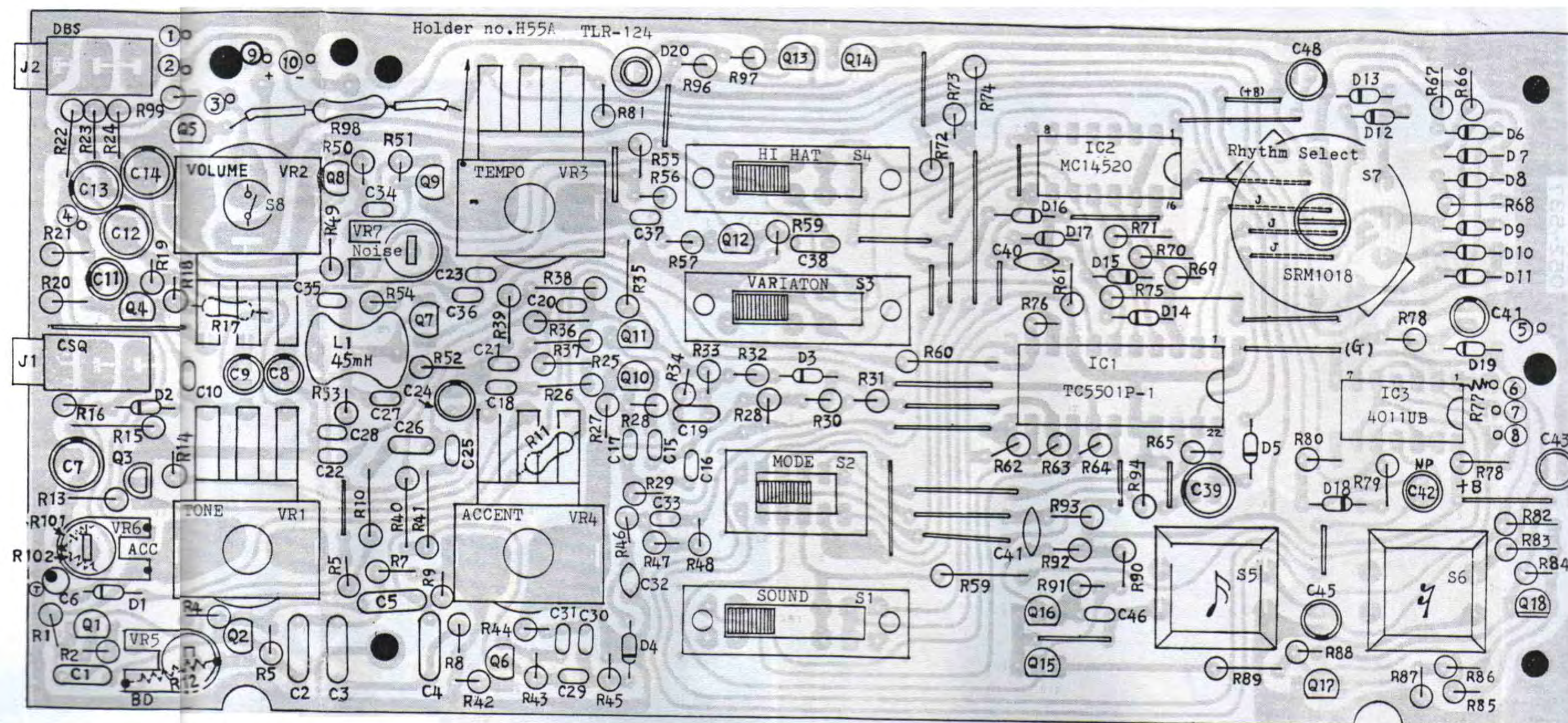



(For writing rhythm patterns, refer to page 4 of the DR-55 OWNER'S Manual.)

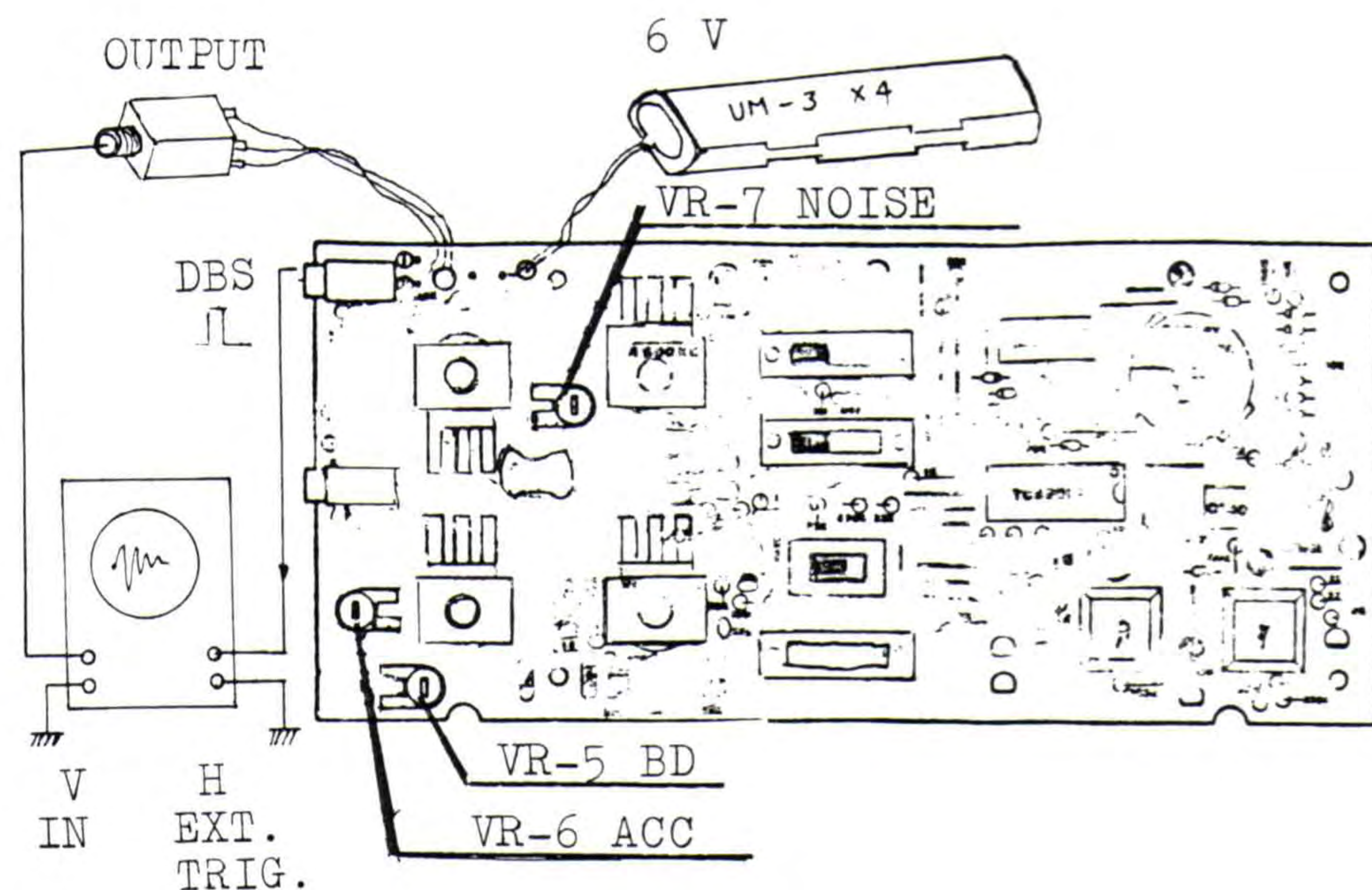

BD (Bass Drum)

No adjustment is needed for the units with serial numbers 912900 and subsequent, -just check.

With following settings, write pattern into DB channel.

- |                  |             |
|------------------|-------------|
| RHYTHM SELECT: 1 | VOLUME: MAX |
| VARIATION: A     | MODE: WRITE |
| HI HAT: OFF      | SOUND: BD   |

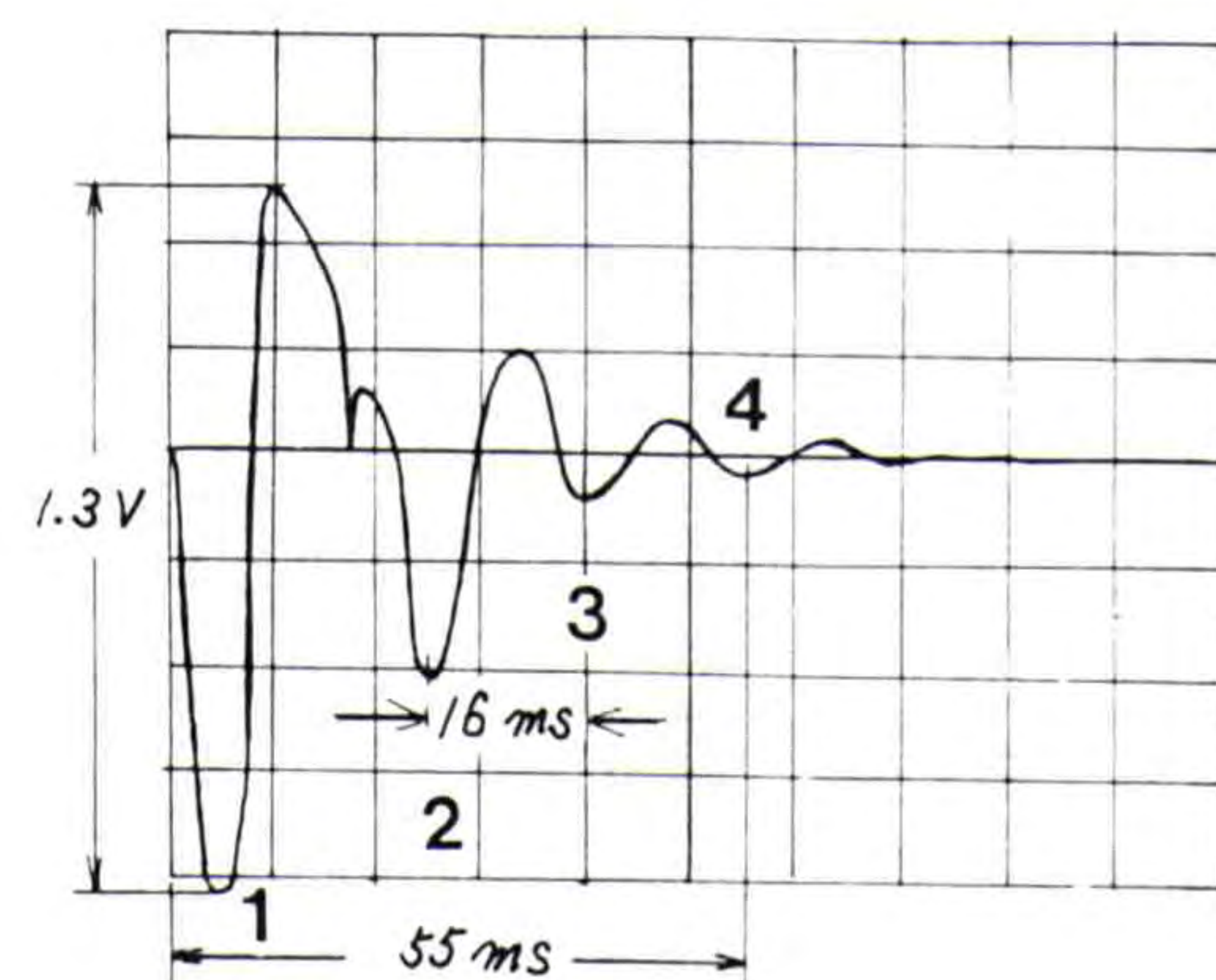
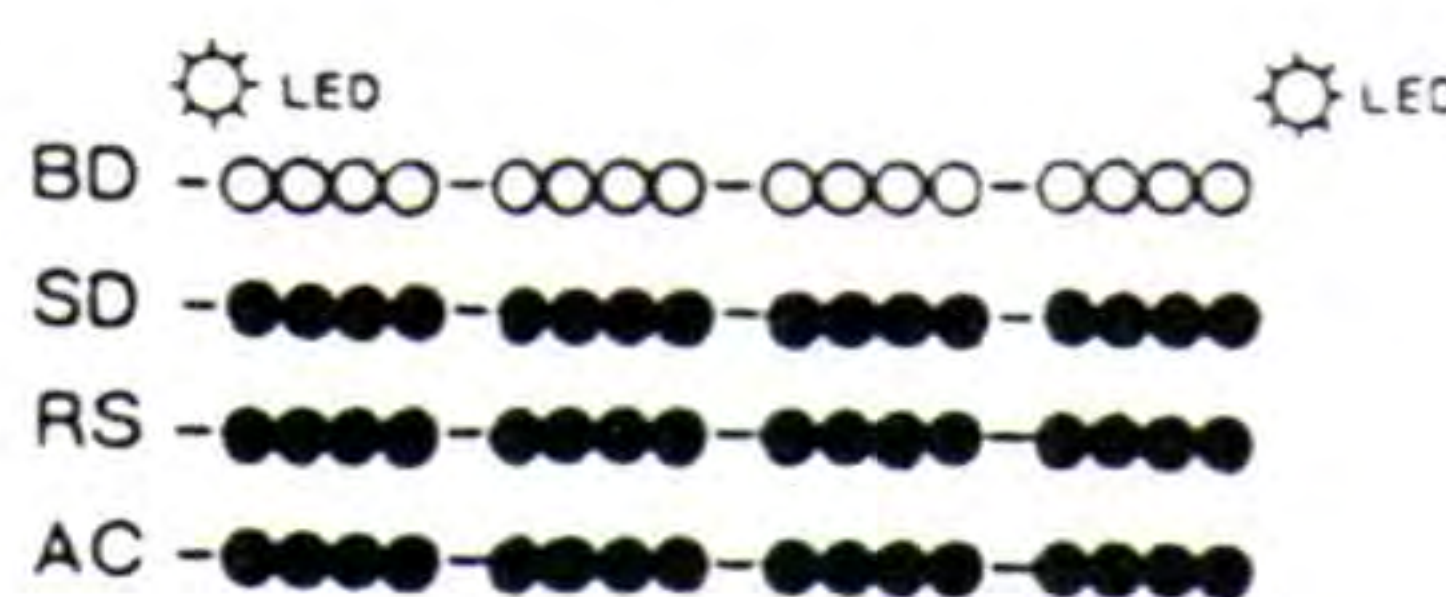

Set MODE to PLAY.  
Press START.  
Set TEMPO for 100 ms DBS pulse interval.  
Adjust VR-5 for 55 ms decay time.

The waveforms in this page will be observed when DR-55 operates from 6 V dc and will vary with different supply voltages.

RS (Rim Shot) Check only

With panel controls set as below, write and reproduce RS sound.

- |                  |             |
|------------------|-------------|
| RHYTHM SELECT: 1 | HI HAT: OFF |
| VOLUME: MAX      | TONE: MAX   |
| ACCENT: MIN      | SOUND: RS   |
|                  | AC          |

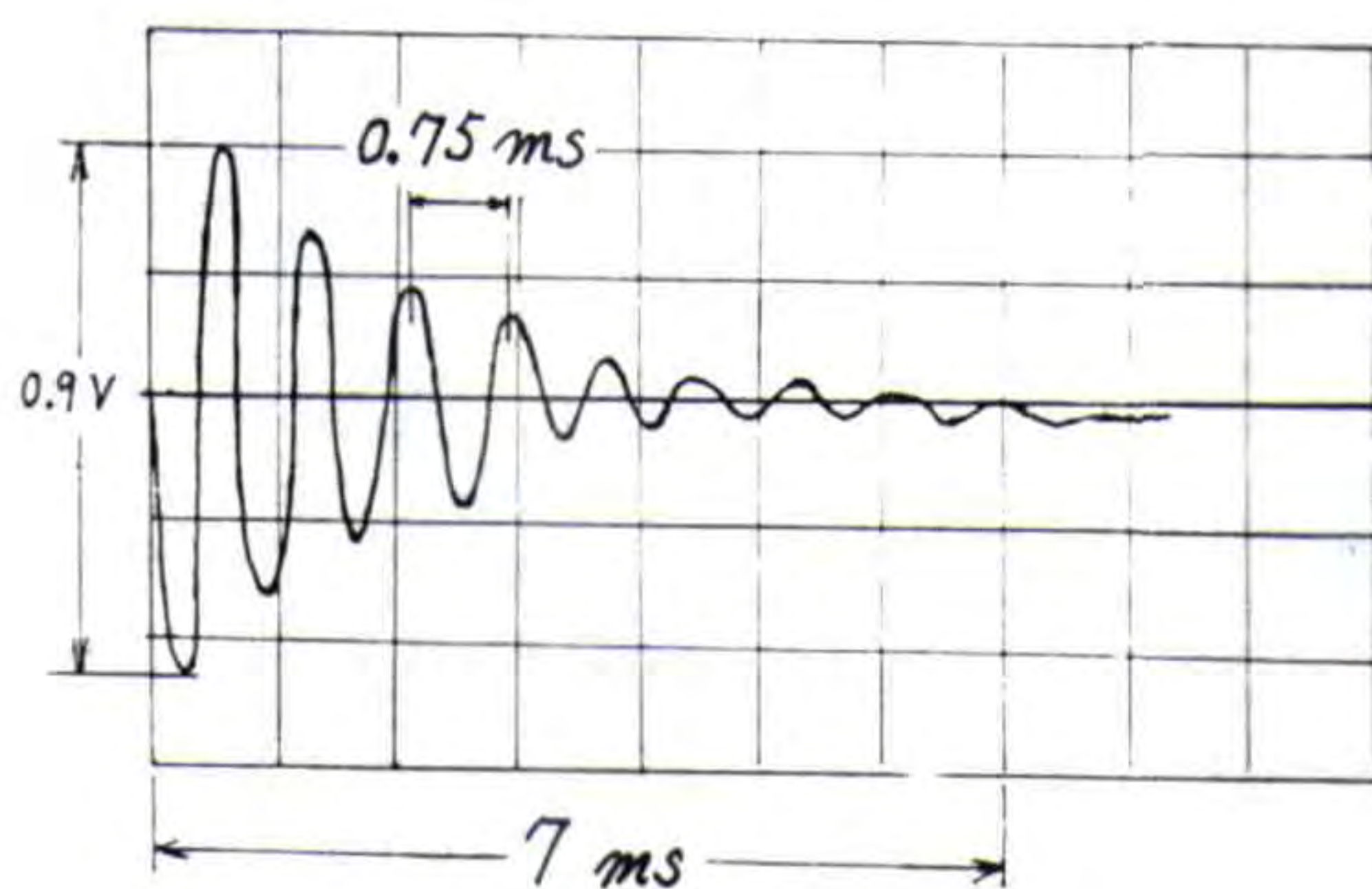

AC (Accent)

(No need for the units with serial numbers 912900 and subsequent.)

While sounding RS in the same manner as above, set controls:

- |             |                           |
|-------------|---------------------------|
| ACCENT: MAX | VARIATION: A              |
| TEMPO: MAX  | SCOPE's Time Base: 0.5 ms |
| HI HAT: OFF |                           |

Turn VR-6 slowly -- in the direction AC increases-- until accentuated RS becomes double normal RS amplitude.  
Note: Turning effect of VR-6 is delayed because of time constant in that circuit.

SD (Snare Drum) check only

With the following settings, write into SD channel.

- |                  |              |
|------------------|--------------|
| RHYTHM SELECT: 1 | VARIATION: A |
| HI HAT: OFF      | VOLUME: MAX  |
| ACCENT: MIN      |              |

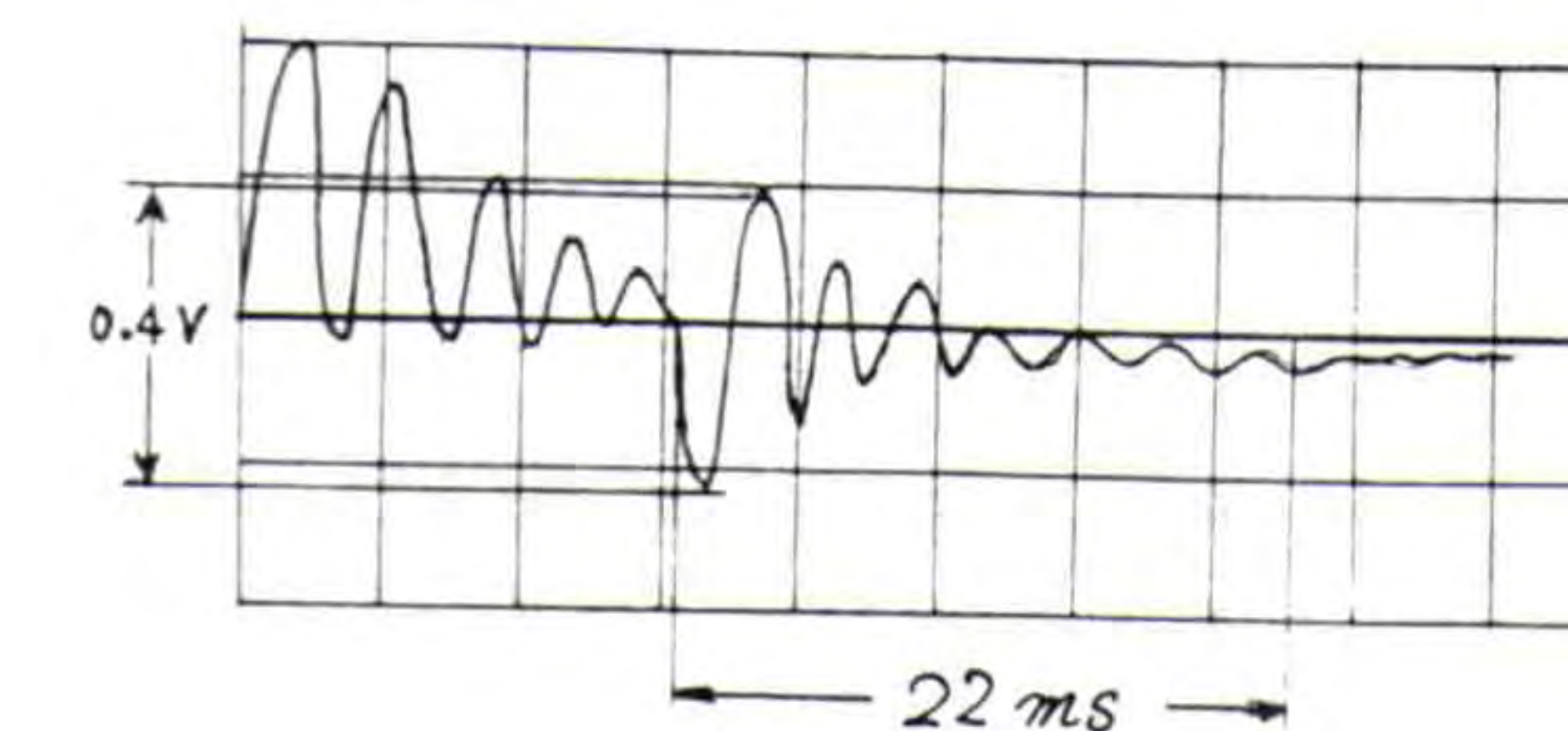
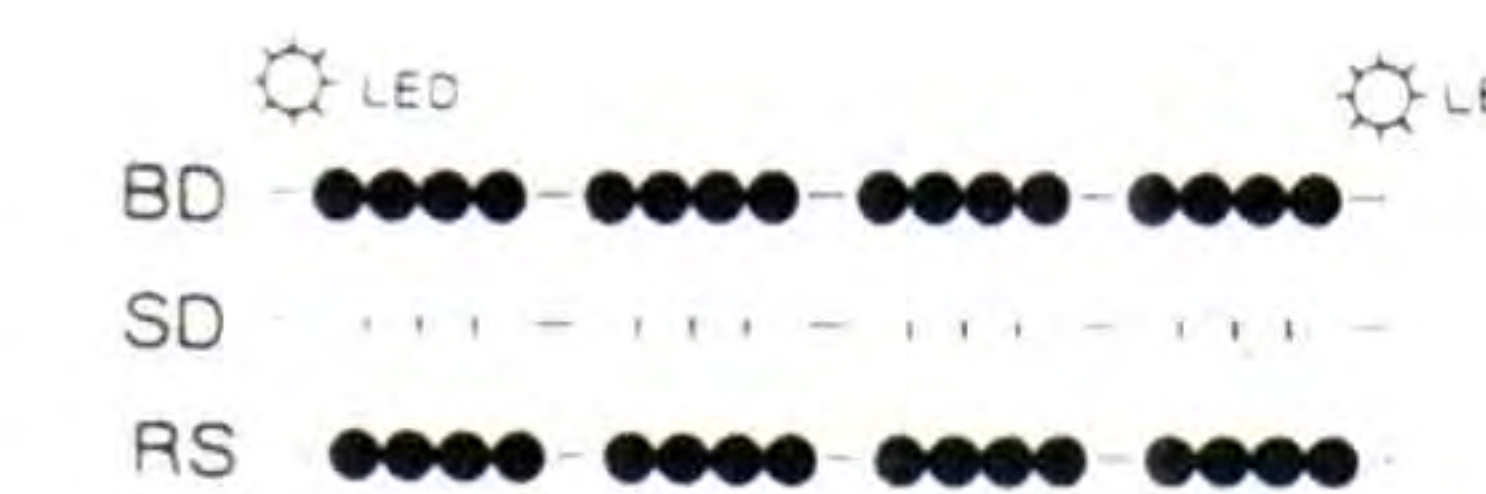

Set MODE to PLAY.  
Press START.  
Minimize NOISE by turning VR-7.

Adjust TEMPO for 100 ms DBS pulse interval.  
Check displayed waveform for the figure above.

HI HAT

Clear all the memories in BD, SD, and RS channels.

- |                     |
|---------------------|
| Set panel controls: |
| RHYTHM SELECT: 1    |
| VARIATION: A        |
| HI HAT: 12-16       |
| VOLUME: MAX         |
| ACCENT: MIN         |

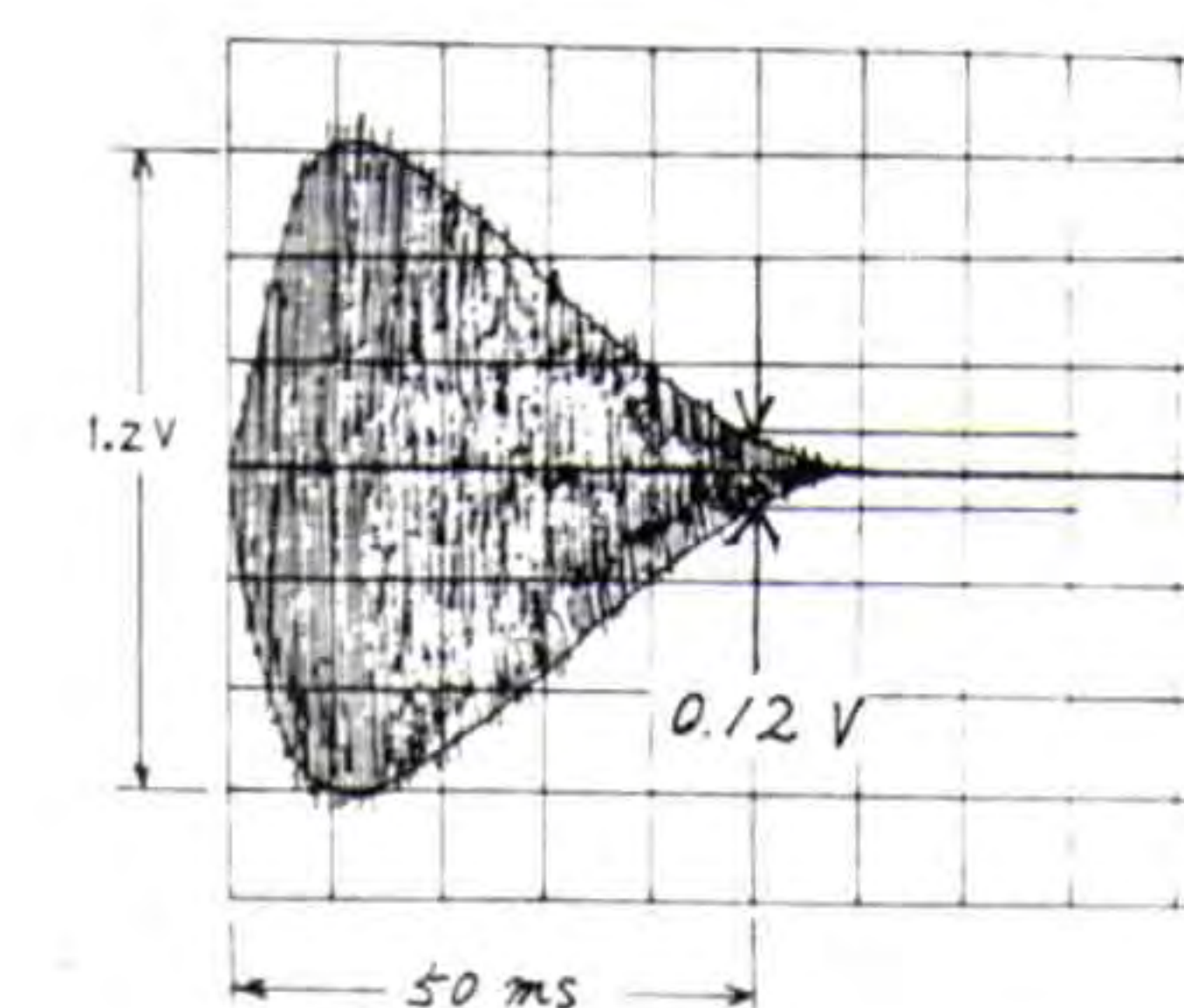
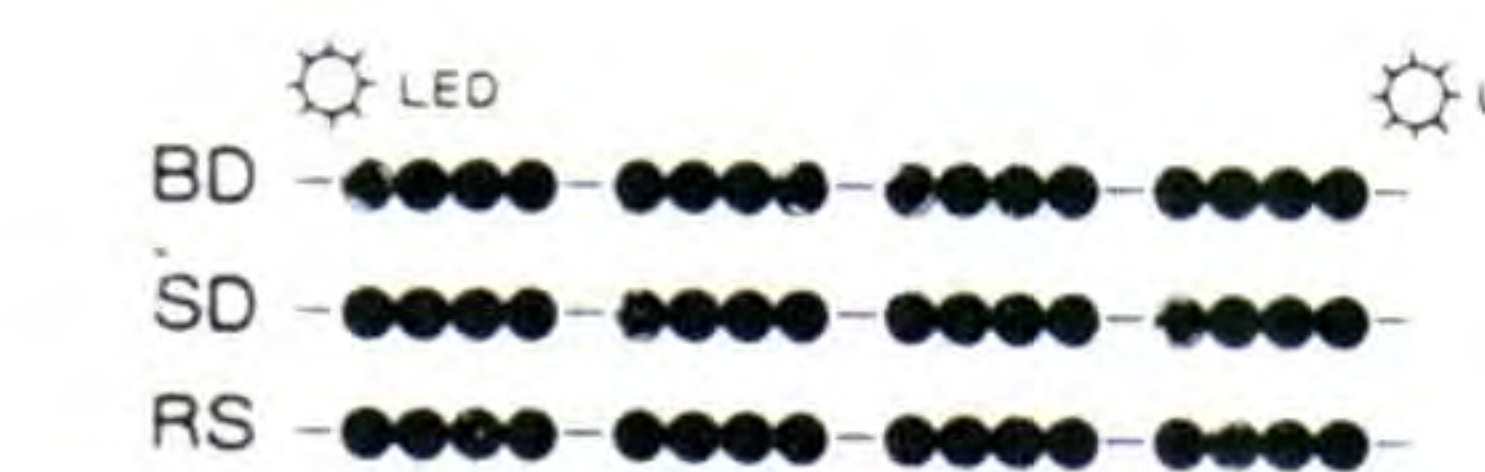

Press START.  
Adjust VR-7 for 1.2 Vpp.

CSQ and DBS (observed at jacks)

TEMPO MAX: 9 ms  
MIN: 12 ms

TEMPO MAX: 12 ms  
MIN: 18 ms

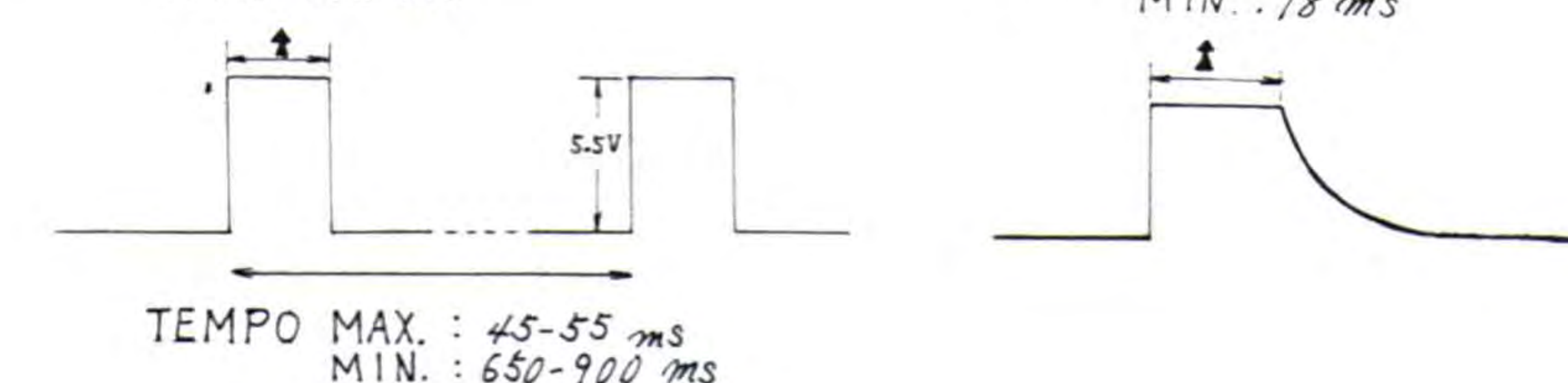



## Free Manuals Download Website

<http://myh66.com>

<http://usermanuals.us>

<http://www.somanuals.com>

<http://www.4manuals.cc>

<http://www.manual-lib.com>

<http://www.404manual.com>

<http://www.luxmanual.com>

<http://aubethermostatmanual.com>

Golf course search by state

<http://golfingnear.com>

Email search by domain

<http://emailbydomain.com>

Auto manuals search

<http://auto.somanuals.com>

TV manuals search

<http://tv.somanuals.com>