

# PERCUSSION SOUND MODULE **TD-10**

## OWNER'S MANUAL

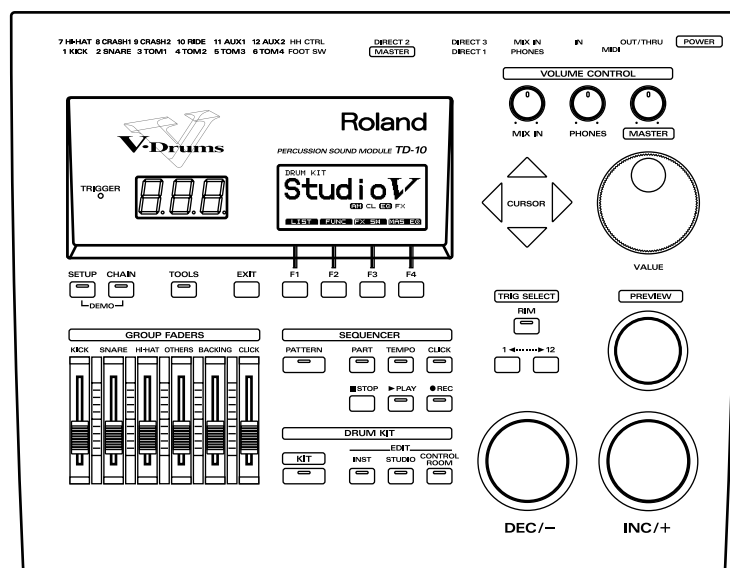

We'd like to take a moment to thank you for purchasing the Roland Percussion Sound Module TD-10.

Before using this unit, carefully read the sections entitled: "IMPORTANT SAFETY INSTRUCTIONS" (p. 2), "USING THE UNIT SAFELY" (p. 3, 4), and "IMPORTANT NOTES" (p. 17). These sections provide important information concerning the proper operation of the unit. Additionally, in order to feel assured that you have gained a good grasp of every feature provided by your new unit, this manual should be read in its entirety. The manual should be saved and kept on hand as a convenient reference.



Copyright © 1997 ROLAND CORPORATION

All rights reserved. No part of this publication may be reproduced in any form without the written permission of ROLAND CORPORATION.

	<b>CAUTION</b> RISK OF ELECTRIC SHOCK DO NOT OPEN	
ATTENTION: RISQUE DE CHOC ELECTRIQUE NE PAS OUVRIR		
<b>CAUTION:</b> TO REDUCE THE RISK OF ELECTRIC SHOCK, DO NOT REMOVE COVER (OR BACK). NO USER-SERVICEABLE PARTS INSIDE. REFER SERVICING TO QUALIFIED SERVICE PERSONNEL.		



The lightning flash with arrowhead symbol, within an equilateral triangle, is intended to alert the user to the presence of uninsulated "dangerous voltage" within the product's enclosure that may be of sufficient magnitude to constitute a risk of electric shock to persons.



The exclamation point within an equilateral triangle is intended to alert the user to the presence of important operating and maintenance (servicing) instructions in the literature accompanying the product.

INSTRUCTIONS PERTAINING TO A RISK OF FIRE, ELECTRIC SHOCK, OR INJURY TO PERSONS.

## IMPORTANT SAFETY INSTRUCTIONS SAVE THESE INSTRUCTIONS

**WARNING** - When using electric products, basic precautions should always be followed, including the following:

1. Read all the instructions before using the product.
2. Do not use this product near water — for example, near a bathtub, washbowl, kitchen sink, in a wet basement, or near a swimming pool, or the like.
3. This product should be used only with a cart or stand that is recommended by the manufacturer.
4. This product, either alone or in combination with an amplifier and headphones or speakers, may be capable of producing sound levels that could cause permanent hearing loss. Do not operate for a long period of time at a high volume level or at a level that is uncomfortable. If you experience any hearing loss or ringing in the ears, you should consult an audiologist.
5. The product should be located so that its location or position does not interfere with its proper ventilation.
6. The product should be located away from heat sources such as radiators, heat registers, or other products that produce heat.
7. The product should be connected to a power supply only of the type described in the operating instructions or as marked on the product.
8. The power-supply cord of the product should be unplugged from the outlet when left unused for a long period of time.
9. Care should be taken so that objects do not fall and liquids are not spilled into the enclosure through openings.
10. The product should be serviced by qualified service personnel when:
  - A. The power-supply cord or the plug has been damaged; or
  - B. Objects have fallen, or liquid has been spilled into the product; or
  - C. The product has been exposed to rain; or
  - D. The product does not appear to operate normally or exhibits a marked change in performance; or
  - E. The product has been dropped, or the enclosure damaged.
11. Do not attempt to service the product beyond that described in the user-maintenance instructions. All other servicing should be referred to qualified service personnel.

For the USA

### GROUNDING INSTRUCTIONS

This product must be grounded. If it should malfunction or breakdown, grounding provides a path of least resistance for electric current to reduce the risk of electric shock.

This product is equipped with a cord having an equipment-grounding conductor and a grounding plug. The plug must be plugged into an appropriate outlet that is properly installed and grounded in accordance with all local codes and ordinances.

**DANGER:** Improper connection of the equipment-grounding conductor can result in a risk of electric shock. Check with a qualified electrician or serviceman if you are in doubt as to whether the product is properly grounded. Do not modify the plug provided with the product — if it will not fit the outlet, have a proper outlet installed by a qualified electrician.

For the U.K.

**WARNING:** THIS APPARATUS MUST BE EARTHED

**IMPORTANT:** THE WIRES IN THIS MAINS LEAD ARE COLOURED IN ACCORDANCE WITH THE FOLLOWING CODE.  
GREEN-AND-YELLOW: EARTH, BLUE: NEUTRAL, BROWN: LIVE

As the colours of the wires in the mains lead of this apparatus may not correspond with the coloured markings identifying the terminals in your plug, proceed as follows:

The wire which is coloured GREEN-AND-YELLOW must be connected to the terminal in the plug which is marked by the letter E or by the safety earth symbol  or coloured GREEN or GREEN-AND-YELLOW.

The wire which is coloured BLUE must be connected to the terminal which is marked with the letter N or coloured BLACK.



The wire which is coloured BROWN must be connected to the terminal which is marked with the letter L or coloured RED.

The product which is equipped with a THREE WIRE GROUNDING TYPE LINE PLUG must be grounded.







# USING THE UNIT SAFELY

## INSTRUCTIONS FOR THE PREVENTION OF FIRE, ELECTRIC SHOCK, OR INJURY TO PERSONS

### About WARNING and CAUTION Notices







 <b>WARNING</b>	Used for instructions intended to alert the user to the risk of death or severe injury should the unit be used improperly.
 <b>CAUTION</b>	Used for instructions intended to alert the user to the risk of injury or material damage should the unit be used improperly. * Material damage refers to damage or other adverse effects caused with respect to the home and all its furnishings, as well to domestic animals or pets.

### About the Symbols





	The  symbol alerts the user to important instructions or warnings. The specific meaning of the symbol is determined by the design contained within the triangle. In the case of the symbol at left, it is used for general cautions, warnings, or alerts to danger.
	The  symbol alerts the user to items that must never be carried out (are forbidden). The specific thing that must not be done is indicated by the design contained within the circle. In the case of the symbol at left, it means that the unit must never be disassembled.
	The  symbol alerts the user to things that must be carried out. The specific thing that must be done is indicated by the design contained within the circle. In the case of the symbol at left, it means that the power-cord plug must be unplugged from the outlet.

### ALWAYS OBSERVE THE FOLLOWING

#### **WARNING**

- Before using this unit, make sure to read the instructions below, and the Owner's Manual. 
- Do not open or perform any internal modifications on the unit. (The only exception would be where this manual provides specific instructions which should be followed in order to put in place user-installable options; see p. 43.) 
- When using the unit with a rack or stand recommended by Roland, the rack or stand must be carefully placed so it is level and sure to remain stable. If not using a rack or stand, you still need to make sure that any location you choose for placing the unit provides a level surface that will properly support the unit, and keep it from wobbling. 
- Use only the attached power-supply cord. 
- Avoid damaging the power cord. Do not bend it excessively, step on it, place heavy objects on it, etc. A damaged cord can easily become a shock or fire hazard. Never use a power cord after it has been damaged. 
- In households with small children, an adult should provide supervision until the child is capable of following all the rules essential for the safe operation of the unit. 









#### **WARNING**

- Protect the unit from strong impact. (Do not drop it!) 
- Do not force the unit's power-supply cord to share an outlet with an unreasonable number of other devices. Be especially careful when using extension cords—the total power used by all devices you have connected to the extension cord's outlet must never exceed the power rating (watts/amperes) for the extension cord. Excessive loads can cause the insulation on the cord to heat up and eventually melt through. 
- Before using the unit in a foreign country, consult with your dealer, or qualified Roland service personnel. 
- Always turn the unit off and unplug the power cord before attempting installation of the circuit board (WAVE & SYSTEM EXPANSION BOARD TDW series; p. 43). 
- Do not put anything that contains water (e.g., flower vases) on this unit. Also, avoid the use of insecticides, perfumes, alcohol, nail polish, spray cans, etc., near the unit. Swiftly wipe away any liquid that spills on the unit using a dry, soft cloth. 

## USING THE UNIT SAFELY

---

### CAUTION

- Always grasp only the plug on the power-supply cord when plugging into, or unplugging from, an outlet or this unit. 
- Try to prevent cords and cables from becoming entangled. Also, all cords and cables should be placed so they are out of the reach of children. 
- Never climb on top of, nor place heavy objects on the unit. 
- Never handle the power cord or its plugs with wet hands when plugging into, or unplugging from, an outlet or this unit. 
- Before moving the unit, disconnect the power plug from the outlet, and pull out all cords from external devices. 
- Before cleaning the unit, turn off the power and unplug the power cord from the outlet (p. 27). 
- Whenever you suspect the possibility of lightning in your area, pull the plug on the power cord out of the outlet. 
- Install only the specified circuit board(s) (WAVE & SYSTEM EXPANSION BOARD TDW series). Remove only the specified screws (p. 43). 

# How to read this owner's manual

This owner's manual is organized as follows.

## Quick Start

This section is intended for those using the TD-10 for the first time, and explains how to use various functions in a simple way. Please read **Quick Start** and follow along by actually operating the TD-10. This will help you understand most of what you need to know for basic operations. If you find unfamiliar words or terms, refer to the "Glossary" on p. 169. More advanced ways of using the TD-10, or details of other operations are explained the **Reference** section.

## Advanced Use

This section explains all functions of the TD-10 in detail and is divided into specific parts. Basic panel operations and displays are covered in the **Quick Start**. The **Advanced Use** section assumes you already understand basic procedures, so if anything's unclear, refer to the "Quick Start."

### Chapter 1. Overview of the TD-10 V-drums

This chapter explains the concept of the TD-10 and how it is organized. Read this chapter in order to understand what the TD-10 is.

### Chapters 2–5. Functions for creating sound

If you wish to learn more about the sound creation possibilities introduced in the "Quick Start," refer to chapters 2–5.

### Chapter 6. Using a sequencer and related functions

This chapter explains sequencer functions such as performance, recording, click settings, and pattern editing.

### Chapter 7. Settings for the entire TD-10

This chapter explains settings that affect the entire TD-10, such as adjusting the overall sound, saving data to a memory card etc.

### Chapters 8 and 9. Convenient functions and how to use them

These chapters explain how to use pads or pedals for pattern play back, and other functions, and about time-saving operations such as copy and help.

### Chapter 10. Functions using MIDI

This chapter explains how to use MIDI—whether it be for saving data to an external device, or for using the TD-10 as a sound module.

## Appendices

If you run into problems, refer to "Troubleshooting" to make sure that the settings are correct. If an error message appears during operation, refer to "Message/Error Message List" and take appropriate action. This section also provides information related to sound editing, MIDI, various lists, and the MIDI implementation charts.

\* *The display screens printed in this owner's manual are based on the factory settings. However, please be aware that in some cases they may differ from the actual factory settings.*

# Contents

IMPORTANT SAFETY INSTRUCTIONS .....	2
USING THE UNIT SAFELY .....	3
How to read this owner's manual .....	5
Features .....	12
Front and rear panel .....	14
Important notes .....	17
About button operations and the screen displays .....	18

## **Quick Start .....21**

### **Before you begin playing.....22**

Mounting the TD-10 to the stand .....	22
Connect your audio system or amp .....	23
Connecting pads and pedals .....	24
Turning on the power .....	26
To turn the power off .....	27
Listening to the internal demo playback .....	28
Specify the pads that the TD-10 will use .....	29
If you have purchased the "V-Basic Kit" or "V-Standard Kit" .....	29
If you have purchased the PD-5, PD-7, PD-9, PD-100 or PD-120 individually .....	30
Using triggers on an acoustic drum to play the TD-10 .....	33
Check the settings .....	34

### **For a better performance .....35**

Concerning the performance & expressiveness of the pads .....	35
Rim shots .....	35
Choking .....	35
Positional sensing .....	36
Playing with brushes .....	36
Hi-hat control pedal .....	36
TD-10 operating procedure .....	37
Adjusting the volume .....	37
Selecting a drum kit .....	38
Adjusting the sensitivity of a pad .....	39
Master equalizer .....	40
Effect on/off .....	41
Help function .....	42
About expansion boards .....	43
À propos des cartes d'extension .....	44
(French language for Canadian Safety Standard)	
Troubleshooting connections and settings .....	45

### **Features of the preset drum kits.....47**

How sounds are created on the V-drums .....	47
No.36: 70's Rock drum kit .....	48
No.37: Brush Kit .....	50
No.38: Electronic drum kit .....	52

## **Modifying a drum kit .....54**

[INST]: Creating drum sounds .....	55
Selecting an instrument.....	55
Modify the material and depth of the body.....	56
Change the material and tuning of the head .....	58
Adjust the muffling (muting) and snare strainer tension.....	60
[STUDIO]: Adjusting the acoustics of the room.....	62
Decide “where” the drums are played.....	63
Change the size of the room.....	64
[CONTROL ROOM]: Adding finishing touches to the sound.....	65
Using the equalizer to modify the sound.....	65
Adjusting the volume balance of the instruments.....	67

## **Examples and convenient tips .....68**

Perform with the on-board sequencer .....	68
Playing back a preset pattern.....	68
Play the pads along with a preset pattern.....	69
Drum Kit Chain—Selecting drum kits in the desired order .....	70
Using a foot switch to select kits .....	72
Using a pad to playback patterns .....	72
Using headphones to hear the click sound .....	73
Using the TD-10 as a MIDI sound module .....	74

# **Advanced Use .....75**

## **Chapter 1. Overview of the TD-10 V-drums.....76**

How the V-drums system is organized.....	76
How to select pads .....	77
Using pads to select the pad/sound for editing .....	77
Using the TD-10 to select the pad/sound for editing.....	77

## **Chapter 2. Settings for the entire drum kit ....78**

Selecting a kit.....	78
Selecting kits from the list display .....	78
Naming a kit .....	78
Making settings for brush performance .....	79
Effect switches for the entire kit.....	79

---

## Chapter 3. Instrument settings .....80

Selecting an instrument.....	80
Selecting instruments from the list display .....	80
Editing an acoustic drum kit (V-EDIT) .....	81
Selecting the shell material.....	81
Changing the shell depth.....	82
Selecting the head material.....	82
Tuning the head .....	82
Muffling settings (muting) .....	83
Adjusting the snare strainer tension .....	83
Editing an electronic drum kit (V-EDIT) .....	84
Editing a TR-808/909 (V-EDIT) .....	85
Editing hi-hat, cymbals and percussion.....	86

---

## Chapter 4. Studio settings .....87

Settings for the entire drum kit .....	87
Selecting the studio/room.....	87
Changing the size of the room.....	87
Changing the wall material.....	87
Selecting the ambience mike location.....	87
Adjusting the volume and output assignments of the ambience .....	88
Settings for each instrument.....	88
Adjusting the amount of ambience .....	88
Selecting the type of mike and its location.....	88
Settings for each group .....	89
Adjusting the amount of ambience send level for each group .....	89

---

## Chapter 5. Control room settings.....90

Settings for each instrument.....	90
Adjusting volume (level) .....	90
Adjusting pan (stereo location).....	90
Adjusting effect send level .....	90
Selecting output assignments.....	91
Controlling variations in volume (Compressor) .....	91
Customizing the tone (Equalizer).....	92
Settings for the entire drum kit .....	93
Adjusting effect Return level .....	93
Selecting the type of effect.....	93
Editing the effects .....	94
Settings for an entire group .....	96
Adjusting effect send level for an entire group.....	96
Adjusting the volume by group .....	96



## Chapter 6. Sequencer .....97

Basic sequencer operation.....	97
Using Preset Patterns .....	97
Setting the tempo .....	97
Setting the tempo for each pattern.....	97
Temporarily changing the tempo of the currently-playing pattern.....	97
Playback functions .....	98
Selecting a pattern.....	98
Selecting patterns from the list .....	98
Selecting how a pattern will playback.....	98
Click settings .....	99
Click on/off and volume settings .....	99
Setting the tempo .....	99
Setting the time signature and click interval .....	99
Selecting the click sound.....	100
Using ambience.....	100
Using effects .....	100
Adjusting the pan (stereo location) .....	100
Selecting the output destination.....	100
Recording .....	101
Basic recording procedure.....	101
The Rehearsal function .....	102
Using a count-in.....	102
Start recording the moment that you strike a pad.....	102
Correcting timing as you record (Quantize).....	103
Importing data from another sequencer into the TD-10 .....	103
Editing a pattern .....	103
Naming a pattern.....	103
Erasing a pattern .....	104
Erasing selected measures of a pattern.....	104
Copying a pattern .....	104
Copying selected measures of a pattern.....	105
Clearing a pattern .....	105
Clearing selected measures of a pattern.....	105
Connecting two patterns.....	106
Settings for part instruments .....	106
Adjusting the master tuning .....	106
Instrument selection and settings for each part .....	106
Mixer settings for each part.....	107
Muting a specific part.....	107

---

## Chapter 7. Settings for the entire TD-10...108

Changing output assignment for audio received by the MIX IN jack.....	108
Specifying the type of pad.....	108
Basic settings for the trigger parameters (BASIC) .....	109
Detailed settings for the trigger parameters (ADVNCB).....	111
The order in which trigger parameters should be set when using drum triggers.....	112
Adjusting the brightness of the display.....	113
Setting the master equalizer.....	113
Saving data to a memory card .....	114
Loading data from a memory card .....	115
Automatically switching the display (Note Chase).....	115

---

## Chapter 8. Convenient functions.....116

Selecting kits in the desired order (Drum Kit Chain) .....	116
Specifying a Drum Kit Chain.....	116
Naming a Drum Kit Chain.....	116
Copying .....	117
The UNDO function.....	117
Getting help .....	118
Specifying how the Preview button functions.....	118

---

## Chapter 9. Operations using pads and foot switches .....119

Using pads to play patterns (Pad Pattern) .....	119
Using pads to perform button operations (Pad Switch) .....	119
Using foot switches to perform button operations (Foot Switch).....	120

---

## Chapter 10. Functions using MIDI .....121

Saving/Loading data to/from an external device (Bulk Dump) .....	121
Saving data .....	121
Loading saved data to the TD-10.....	121
Setting the Device ID—Transmitting saved data to two or more TD-10 units.....	122
Using pads to play an external MIDI sound module.....	122
Selecting the note number transmitted by each pad .....	122
Setting the Gate Time .....	123
Setting the MIDI channel.....	123
Using the TD-10 with the Roland SPD-11 .....	123
MIDI settings for the entire TD-10 .....	124
Setting the MIDI channels for each Part.....	124
Turning off Local Control.....	124
Disabling reception or transmission of Program Changes.....	124
Reducing the amount of data transmitted by the FD-7 (Pedal Data Thin) .....	124
Using the TD-10 as a sound module.....	125
Setting the instrument for each part .....	125
Adjusting the mixer settings for each part.....	125
Regarding note numbers for the drum kit sounds .....	125
Using the percussion group .....	126
Changing the kit number that is selected by a program change .....	128

MIDI messages for detailed performance expressions .....128  
     Messages for hi-hat control .....128  
     Messages for positional sensing (snare drum and ride cymbal only).....129  
 Synchronization with external MIDI devices.....129

**Appendices ..... 131**

Troubleshooting.....132  
 Instruments that can be used with each trigger.....136  
 Restoring the factory settings (INITIALIZE).....137  
 Message / error message list .....138  
 About MIDI .....140  
 Using drum triggers .....142  
 Preset list.....143  
 MIDI implementation .....154  
 MIDI implementation chart .....165  
 Specifications .....168  
 Glossary .....169  
 Index of screen displays.....173  
 Index.....176

\* *PinStripe* is a registered trademark of Remo Inc. U.S.A.

# Features

## ● Enhanced tonal quality and expressiveness that rivals acoustic drums

The TD-10 features a newly developed modeling sound module that relies on COSM technology. The force and position of the hit are detected, providing sensitive and dynamic expression that is extremely close to that of acoustic drums. In addition, when PD-100 or PD-120 (optional) pads are used, you can enjoy excellent response when playing rolls.

\* *COSM (Composite Object Sound Modeling) is a Roland technology which combines multiple sound modeling processes to create new sounds.*

\* *Positional detection is possible on snare drums and ride cymbals.*

## ● With 600 drum sounds and 54 backing instrument provided

A rich array of instrumental sounds are provided, sufficient to cover all styles of music.

## ● A user interface comfortable for drummers

You can create sounds much in the same way that you would using acoustic drums when you select a preferred drum head, tune it, and attach muffling (muting) material. With the large display, the use of graphics and icons to portray parameters being set and their meanings, operation is intuitive and easily understood.

## ● High-speed trigger response

The triggering time (time delay from hitting the pad until you hear the sound) is faster than ever, allowing expressiveness and dynamics to be reproduced accurately.

## ● Twelve pads can be used simultaneously

Since up to twelve pads can be used simultaneously, you can create large-scale setups bigger than ever before. This also gives you flexibility for extended applications, such as using pads as switches (Pad Switch) or for pattern playback (Pad Pattern).

## ● Simulate the entire process of actual recording

By being able to choose drum materials, sizes, studio location, mike types and their settings, effects and mixer parameters, the TD-10 allows total flexibility for recording or live applications. All of these settings can be stored as part of a drum kit, for instant recall at any time.

## ● Perform using brushes

If you use the PD-100 or PD-120 pads, you can play with brushes, something not possible with any previous electronic drum system. (Nylon brush only please!).

## ● Sound processing specially selected for drums

For each instrument assigned to trigger inputs 1–10, individual two-band equalizers and compressors are provided. In addition, (in the control room) —there are digital effects: reverbs, flanger, chorus, delays, pitch shift delay, and phaser. A three-band equalizer is also provided for processing the sound at the MASTER OUT. Ambience (in the Studio) lets you choose WHERE the drums are being played. You can change the sound of that space by changing the material of the walls, size of the room and the position of the ambient mikes. There are individual ambience send levels for all instruments.

## ● Functions and operations perfect for live performances

The group faders on the front panel let you make quick changes as needed during performance. You can play drum kits in any desired order (Drum Kit Chain). The INC/DEC buttons are large enough to be pressed with a drum stick. (Don't HIT them!) Another very useful function allows you to send the click sound ONLY to the headphones if desired. An audio input (stereo) for custom monitoring (MIX IN jack) is also provided.

## ● Easy-operation sequencer is built-in

With easy, tape recorder-like operations, you can record or play back patterns. In addition to the drums, three backing parts can be added for ensemble practice or for creating backing patterns via MIDI keyboard, external sequencer etc.

\* *Brush swish/sweeping and choke cannot be recorded.*

## ● Previous models of pads can be used

Previous pad models (PD-5, PD-7, PD-9), kick trigger units (KD-5, KD-7) and the hi-hat control pedal (FD-7) are all compatible. Also, the PD-7 and PD-9 allow positional sensing for the snare drum and ride cymbal.

## ● User Installable Expansion boards allow extended functionality

WAVE & SYSTEM EXPANSION BOARD TDW series will bring more instruments and drum kits to the TD-10, and allows the system to be upgraded through Flash ROM. A memory card (M-512E) can be used to store all kits and patterns for the TD-10.

## ● Usable as a MIDI sound module

Percussion groups are provided so these sounds can be accessed via MIDI as with a dedicated module, so in addition to sounds assigned to the 12 trigger inputs, a special note map for percussion allows 72 types of instruments to be accessed simultaneously.

# Front and rear panel

## Front Panel

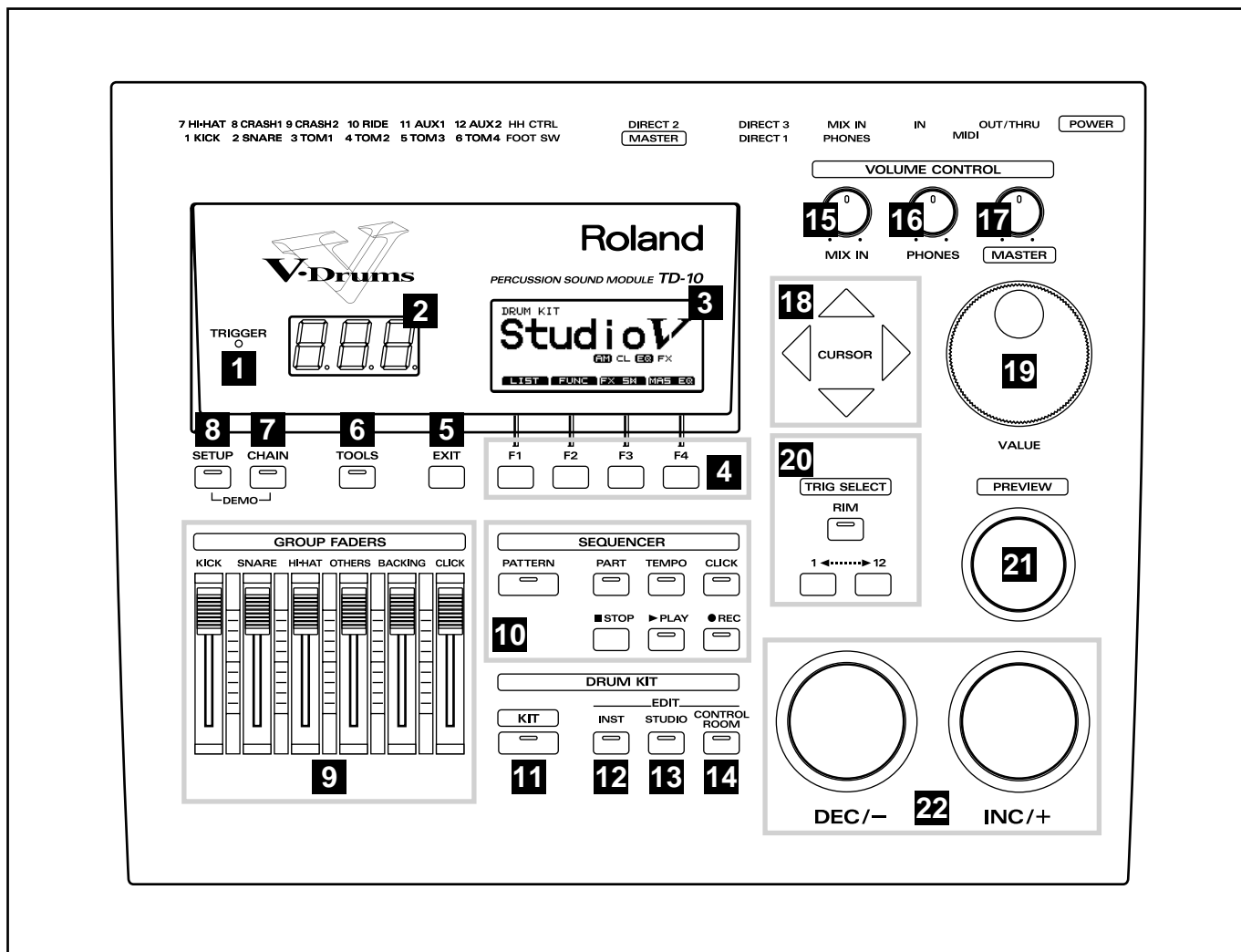

### 1 Trigger Indicator

This will light when a trigger signal (signal produced when pad is struck) is received from a pad. It allows you to check whether the pad has been connected correctly.

### 2 LED Display

Displays the number of the currently selected drum kit.

### 3 Graphic Display

During performance, this indicates the drum kit name and other important information. During editing, various graphics and text relative to the editing process is indicated.

\* In this owner's manual, this will be referred to simply as "the display."

### 4 F1-F4 Buttons

These buttons change their function depending on the contents of the display. The lower part of the display will indicate the function of each button (p. 18).

### 5 EXIT Button

Press this button and you will return to the screen one level higher in the hierarchy. Repeated pressing takes you back to the "DRUM KIT" page.

### 6 TOOLS Button

Provides access to functions such as Copy, Undo, and Help. (p. 42, 117)

### 7 CHAIN Button

Lets you make Drum Kit Chain settings (a function that arranges drum kits in a desired order for successive selection) (p. 70, 116).

### 8 SETUP Button

Here you can make settings that affect the entire TD-10, such as trigger parameters and MIDI settings (p. 108).

**9 GROUP FADERS**

These allow you to adjust the volume of the kick, snare, hi-hat, other percussion instruments, backing instruments, and the click sound (p. 37).

**10 SEQUENCER**

Here are the buttons that control sequencer functions (playback/recording of performance patterns) (p. 68, 97).

**11 KIT Button**

Provides access to the basic display page used when playing the TD-10.

**12 INST (Instrument) Button**

Provides access to the display page in which you can edit instruments (p. 55, 80).

**13 STUDIO Button**

Provides access to the display page where you can choose mike types, their positions, ambience types and ambient mike positions (p. 62, 87).

**14 CONTROL ROOM Button**

Allows you to edit mixer, EQ, compressor and effect parameters (p. 65, 90).

**15 MIX IN Knob**

This adjusts the volume of the device connected to the MIX IN jack. The sound from the MIX IN will be output from the MASTER out and/or the PHONES jack.

**16 PHONES Knob**

Adjusts the headphone volume. Even when headphones are connected, sound will still be output from the various output jacks.

**17 MASTER Knob**

Adjusts the volume of the MASTER OUT jacks. The volume of the PHONES jack is adjusted by the PHONES knob.

**18 CURSOR Buttons**

Used to move the cursor in the display, or to access the next display page (p. 18).

**19 VALUE Dial**

This dial has the same function as the INC and DEC buttons. Use this dial when you wish to make large changes in drum kit settings or edited values (p. 19).

**20 TRIG SELECT**

Use the lower two buttons to select the pad (trigger number) for which you wish to make settings. To select the rim of a pad, press the RIM button, then the RIM indicator is lit. If pads are connected to the TD-10, you can also select a pad by striking it. The PREVIEW button lets you audition the instrument that is assigned to the selected pad or the sound appearing in the display when editing a percussion group (p. 20).

**21 PREVIEW Button**

Used to audition an instrument. By using TRIG SELECT buttons to select a pad, you can play and edit sound even if no pads are connected to the TD-10. The button is velocity sensitive (p. 20).

**22 INC Button, DEC Button**

These buttons are used to switch drum kits or to modify values. Pressing the INC button increases the value, and pressing the DEC button decreases it. Since these buttons are large, you can also use the tip of your drum stick to press them (p. 19).

*\* Please be aware that hitting the buttons with a stick can cause malfunctions.*

## Rear Panel

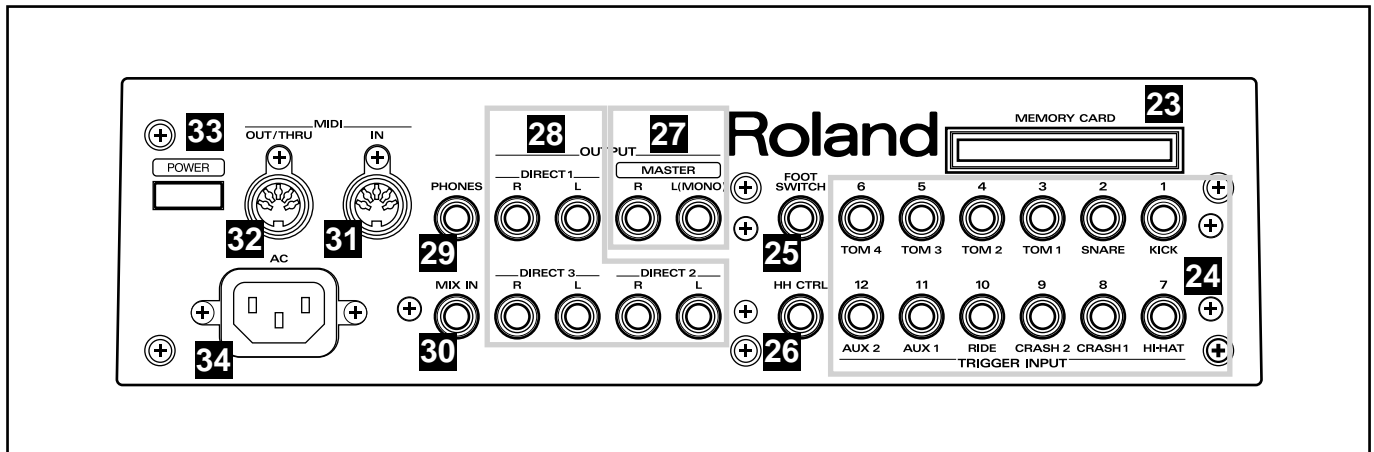

### 23 MEMORY CARD Slot

An M-512E memory card (optional) can be inserted into this slot. Each memory card can store all settings of the TD-10, such as drum kits and sequencer performance data, etc (p. 114).

*\* The M-512E is the only memory card that can be used by the TD-10.*

### 24 TRIGGER INPUT Jacks

Accept the pads or kick trigger units you want to connect to the TD-10. To connect a dual trigger type pad (PD-7, PD-9, PD-120), use a stereo cable (p. 24).

### 25 FOOT SWITCH Jack

Accepts connection of an optional foot switch (FS-5U). A foot switch can be used to select kits and start/stop the sequencer, etc. Use a special PCS-31 cable (optional) (p. 72, 120).

### 26 HH CTRL Jack

Accepts connection of a hi-hat control pedal (FD-7) (p. 36).

### 27 OUTPUT (MASTER) Jacks

These jacks output the instrumental sounds of the TD-10, and are for connection to external audio devices or amps. If you are listening in mono, connect to only the MASTER L (MONO) jack (p. 23).

### 28 OUTPUT (DIRECT 1, 2, 3) Jacks

The direct outs allow you to have more “separation,” over the total kit, and can be used for external effects etc. Ambience may also be sent from these outputs, but NOT the digital effects. Output assignments DIRECT 1, 2 or 3 jacks are found in the Control Room (p. 91).

### 29 PHONES Jack

A pair of stereo headphones can be connected to this jack. Even if headphones are connected, sound will still be output from the OUTPUT jacks (p. 23).

### 30 MIX IN Jack

This jack is used to connect a CD or cassette player, or as a custom monitoring input for live/recording performances. The sound that is input to this jack will be output from the MASTER out jacks and/or the PHONES jack (p. 108).

### 31 MIDI IN Connector

Use this connector when you wish to use an external MIDI sequencer to play the sounds of the TD-10, or when loading TD-10 settings (bulk data) that were saved on an external device (p. 121).

### 32 MIDI OUT/THRU Connector

Use this connector when you wish to use play sounds in an external MIDI sound module/sampler from the pads, or when you wish to transmit TD-10 settings (bulk data) to another MIDI device (p. 121).

### 33 POWER Switch

This switch turns the power on/off (p. 26).

### 34 AC Inlet

Connect the included AC power cable to this inlet (p. 23).



# Important notes

In addition to the items listed under "IMPORTANT SAFETY INSTRUCTIONS" and "USING THE UNIT SAFELY" on pages 2–4, please read and observe the following:

## Power Supply

- Do not use this unit on the same power circuit with any device that will generate line noise (such as an electric motor or variable lighting system).
- Before connecting this unit to other devices, turn off the power to all units. This will help prevent malfunctions and/or damage to speakers or other devices.

## Placement

- Using the unit near power amplifiers (or other equipment containing large power transformers) may induce hum. To alleviate the problem, change the orientation of this unit; or move it farther away from the source of interference.
- This device may interfere with radio and television reception. Do not use this device in the vicinity of such receivers.
- Do not expose the unit to direct sunlight, place it near devices that radiate heat, leave it inside an enclosed vehicle, or otherwise subject it to temperature extremes. Excessive heat can deform or discolor the unit.

## Maintenance

- For everyday cleaning wipe the unit with a soft, dry cloth or one that has been slightly dampened with water. To remove stubborn dirt, use a cloth impregnated with a mild, non-abrasive detergent. Afterwards, be sure to wipe the unit thoroughly with a soft, dry cloth.
- Never use benzene, thinners, alcohol or solvents of any kind, to avoid the possibility of discoloration and/or deformation.

## Repairs and Data

- Please be aware that all data contained in the unit's memory may be lost when the unit is sent for repairs. Important data should always be backed up on a RAM card/DATA card, in another MIDI device (e.g., a sequencer), or written down on paper (when possible). During repairs, due care is taken to avoid the loss of data. However, in certain cases (such as when circuitry related to memory itself is out of order), we regret that it may not be possible to restore the data, and Roland assumes no liability concerning such loss of data.

## Memory Backup

- This unit contains a battery which powers the unit's memory circuits while the main power is off. When this battery becomes weak, the message shown below will appear in the display. Once you see this message, have the battery replaced with a fresh one as soon as possible to avoid the loss of all data in memory. To have the battery replaced, consult with your dealer, or qualified Roland service personnel.  
**"Backup Battery Low !"**

## Additional Precautions

- Please be aware that the contents of memory can be irretrievably lost as a result of a malfunction, or the improper operation of the unit. To protect yourself against the risk of losing important data, we recommend that you periodically save a backup copy of important data you have stored in the unit's memory on a RAM card/DATA card, in another MIDI device (e.g., a sequencer).
- Unfortunately, it may be impossible to restore the contents of data that was stored on a RAM card/DATA card, in another MIDI device (e.g., a sequencer), in the unit's memory once it has been lost. Roland Corporation assumes no liability concerning such loss of data.
- Use a reasonable amount of care when using the unit's

buttons, sliders, or other controls; and when using its jacks and connectors. Rough handling can lead to malfunctions.

- Never strike or apply strong pressure to the display.
- When connecting / disconnecting all cables, grasp the connector itself—never pull on the cable. This way you will avoid causing shorts, or damage to the cable's internal elements.
- A small amount of heat will radiate from the unit during normal operation.
- To avoid disturbing your neighbors, try to keep the unit's volume at reasonable levels. You may prefer to use headphones, so you do not need to be concerned about those around you (especially when it is late at night).
- Since sound vibrations can be transmitted through floors and walls to a greater degree than expected, take care not to allow such sound to become a nuisance to neighbors, especially at night and when using headphones. Although the drum pads and pedals are designed so there is a minimal amount of extraneous sound produced when they're struck, rubber heads tend to produce louder sounds compared to mesh heads. You can effectively reduce much of the unwanted sound from the pads by switching to mesh heads.
- When you need to transport the unit, package it in the box (including padding) that it came in, if possible. Otherwise, you will need to use equivalent packaging materials.
- Use a cable from Roland to make the connection. If using some other make of connection cable, please note the following precautions.
  - Some connection cables contain resistors. Do not use cables that incorporate resistors for connecting to this unit. The use of such cables can cause the sound level to be extremely low, or impossible to hear. For information on cable specifications, contact the manufacturer of the cable.

## Before Using Cards Using DATA Cards

- New M-512E DATA cards do not yet have their battery installed. Before a DATA card can be used, you first need to insert the battery (refer to the instructions supplied with the DATA card).
- M-512E DATA cards are equipped with a PROTECT switch, which when turned on protects your data from accidental erasure. It is recommended that the switch be kept at the ON position, and switched to OFF only at the times you wish to write new data onto the card.

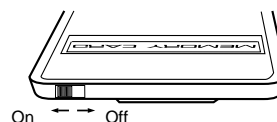

- When the battery in an M-512E DATA card is nearly worn out, the message below will be shown in the display. Refer to the instructions supplied with the DATA card and promptly replace the battery to avoid the loss of the data on it.  
**"MEMORY CARD Battery Low ! Please Change !"**
- Carefully insert the DATA card all the way in—until it is firmly in place.

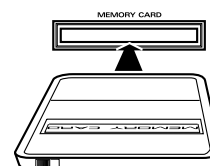

- Never touch the terminals of the DATA card. Also, avoid getting the terminals dirty.

# About button operations and the screen displays

Operations common to all aspects of operating the TD-10 are covered below.

## ■ Saving your settings

For operations within the TD-10, there is no procedure for “saving settings.” When you modify the value of a setting, the new value is automatically saved as soon as you make the change.

## ■ Buttons, sliders and knobs

Buttons, sliders and knobs on the front panel will be printed in square brackets [ ]; e.g., [SETUP].

## ■ Cursor

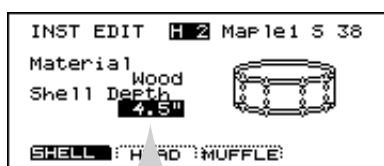

Cursor

Cursor refers to the highlighted characters indicating an on-screen item that can be set. If the screen contains more than one item that can be set, use the [CURSOR] buttons to move it to the item that you wish to set.

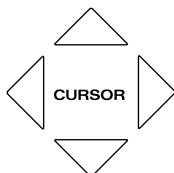

## ■ Function buttons ([F1]–[F4])

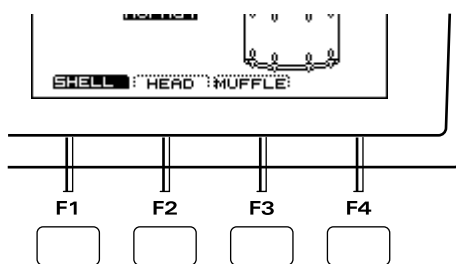

The [F1]–[F4] buttons are called the “function buttons.” The bottom part of the display will show the names of the functions available for [F1]–[F4]. For example, if this owner’s manual makes reference to [INST]-[F1 (SHELL)], press [INST] , and then press [F1] (in this case, “SHELL” is displayed above [F1]).

## ■ How to modify settings

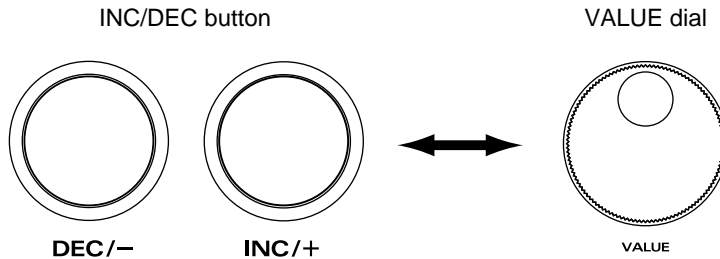

[INC] and [DEC] (referred to in this manual as [INC/DEC]) and the VALUE dial are both used to modify the values of settings. The two methods have the following advantages.

### [INC/DEC]

- Each time [INC] is pressed, the value increases. Each time [DEC] is pressed, the value decreases. This is convenient for fine adjustments.
- When making an on/off setting, [INC] will turn the setting on and [DEC] will turn it off.
- If you hold down [INC] and press [DEC], the value will increase rapidly. If you hold down [DEC] and press [INC] the value will decrease rapidly.

### VALUE dial

Since the dial allows you to make major changes to the value at once, it's a convenient way to make broad adjustments to a parameter quickly.

## ■ About the upper right of the screen display

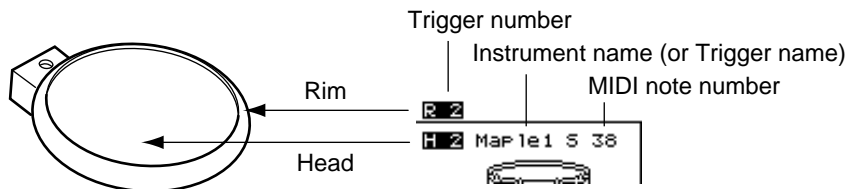

In pages that allow you to make settings for each pad, you can strike the desired pad to see the setting page for that pad. At this time, the upper right of the display will show the number of the trigger jack to which the selected pad is connected, the instrument that it is using, and the MIDI note number. The first character (“H” or “R”) indicates whether the head or the rim of the pad is selected. The numerals at the right are the MIDI note number. You will need to know the MIDI note number when using the TD-10 as a MIDI sound module.

The “H” or “R” display will indicate whether the head or rim will sound when you press the Preview button. In cases where settings for the head and rim can be edited separately, the following characters will also be displayed, letting you know the page in which you are.

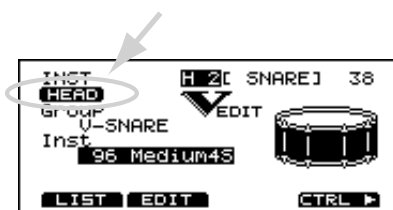

## ■ Selecting pads from the TD-10 front panel

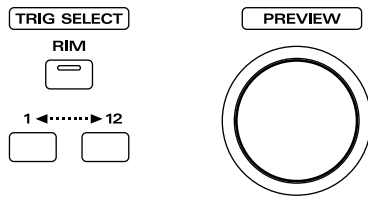

The trigger select buttons ([TRIG SELECT]) are used when you wish to select a sound for editing from the front panel of the TD-10, rather than by striking a pad as explained above. You can use these buttons to select a trigger number and edit the settings.

When you press the button marked “1,” the next lower-numbered trigger will be selected. When you press the button marked “12,” the next higher-numbered trigger will be selected.

When using a PD-7, PD-9 or PD-120, the rim button ([RIM]) lets you specify whether you are making settings for the head or the rim. When the [RIM] indicator is lit, the rim is selected.

By using these buttons in conjunction with the preview button, you can edit without pads connected to the TD-10.

\* Depending on the instrument selection, there will be no distinction between head and rim in some cases. For details refer to p. 136.

## ■ About the Preset Drum Kits

When the instrument is shipped from the factory, drum kits 1–50 are already pre-loaded. Even if you modify the settings of these drum kits, you can restore them to their factory settings at any time. These drum kits are referred to as the Preset Drum Kits. For details, refer to p. 137.

## ■ About the basic screen



This screen is the TD-10's basic screen, which will appear when you press [KIT].

In addition to the kit name, it displays the status of the memory card (p. 78), the effect on/off setting (p. 79), and whether or not the kit is for brushes (p. 79) etc.



# Quick Start

# Before you begin playing

This section explains the connections and settings that you must make before playing. The explanations here are given, assuming that the TD-10 has its factory settings.



*The TD-10 provides a function for restoring the factory settings. Refer to “Restoring the factory settings (INITIALIZE)” on p. 137.*

## Mounting the TD-10 to the stand

Attach the stand holder (included with the optional MDS-7U/10) to the TD-10.

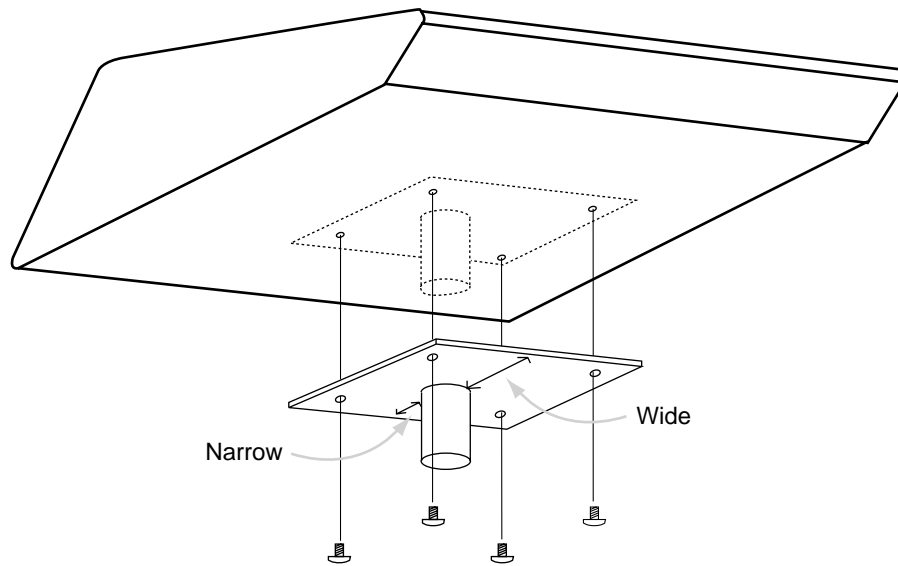

Using the included screws, attach it so that the unit is oriented as shown in the above diagram.



*Use the included screws. Using other screws can cause damage.*

Next, attach the TD-10 to the drum stand (MDS-7U/10).

For details on assembling the drum stand and attaching the TD-10, refer to the owner's manual for the drum stand (MDS-7U/10).



*To attach the TD-10 to a cymbal stand (or the like), you may want to make use of the separately available APC-33 All Purpose Clamp.*

*Make sure, though, that the cymbal stand you intend to use has pipes with a diameter of between 10.5 and 30 millimeters.*

## Connect your audio system or amp

### NOTE

To prevent malfunction and/or damage to speakers or other devices, always turn down the volume, and turn off the power on all devices before making any connections.

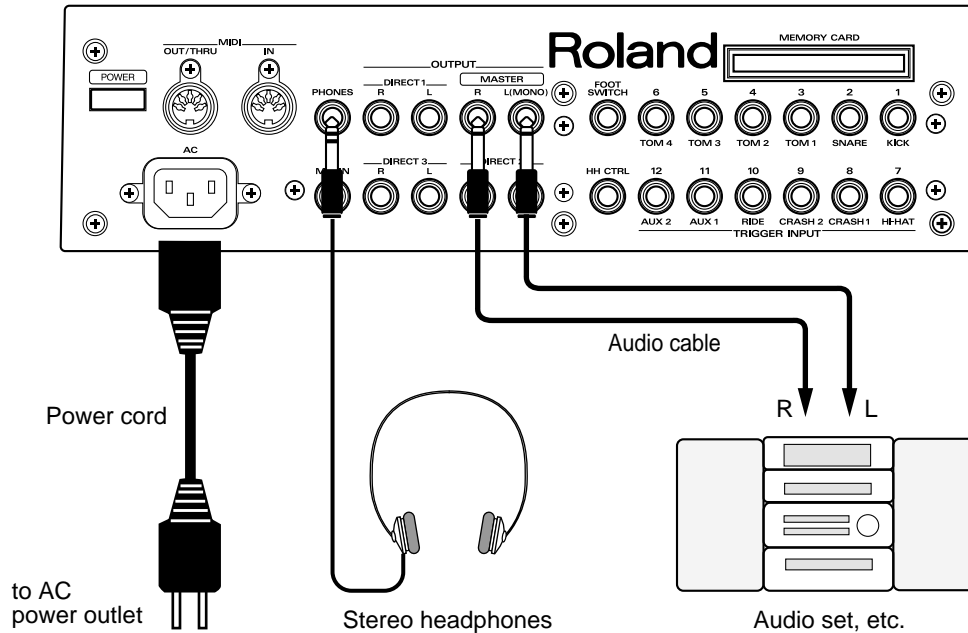

Connect the rear panel MASTER L(MONO) and R jacks to your audio system or amps. If you will be using headphones, connect them to the PHONES jack.

### NOTE

Be sure that the TD-10's MASTER L and R jacks are connected respectively to the L and R of your audio system or amps.

In consideration of live performance situations, the headphone output is designed to produce a higher volume than other electronic musical instruments. Extended listening at high volumes will damage your hearing, so please pay attention to the volume adjustment.

### MEMO

At the factory settings, no sound will be output from the DIRECT 1, DIRECT 2 or DIRECT 3 jacks.

## Connecting pads and pedals

Using the cables provided, connect your pads, hi-hat control pedals and kick trigger units as shown in the above diagram. Special jacks are provided for the kick (KICK) and snare (SNARE), so make the correct connections to these jacks.

TD-10 Rear panel

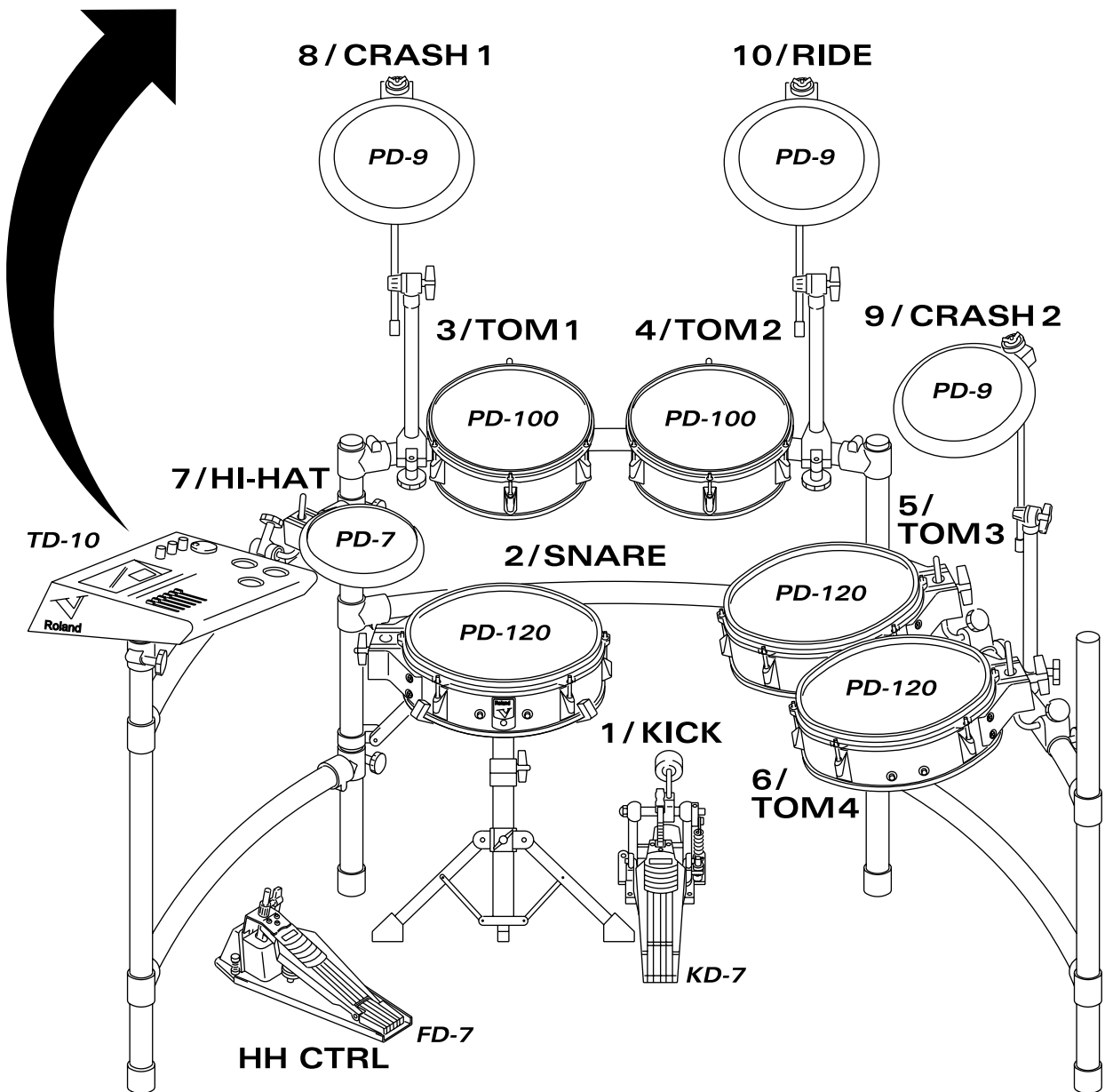
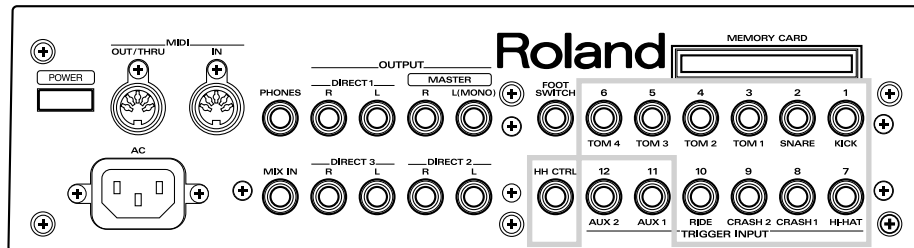



**NOTE**

If you are using a PD-7 or PD-9, move the polarity switch located on the back of the pad to the “-(Roland)” position. When using a KD-7, either position will do.

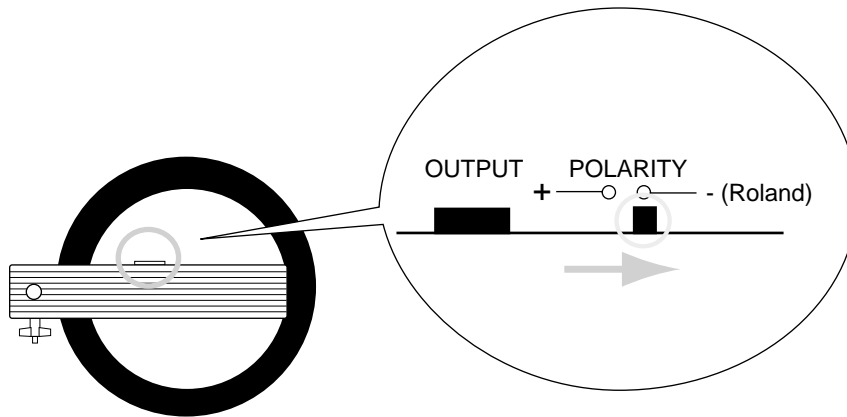

PD-7, PD-9

**MEMO**

To have the most expressive performance, we recommend the use of the Roland pads (PD-5, PD-7, PD-9, PD-100, PD-120) and kick trigger units (KD-7).

## Turning on the power

### NOTE

Once the connections have been completed (p. 23, 24), turn on power to your various devices in the order specified. By turning on devices in the wrong order, you risk causing malfunction and/or damage to speakers and other devices.

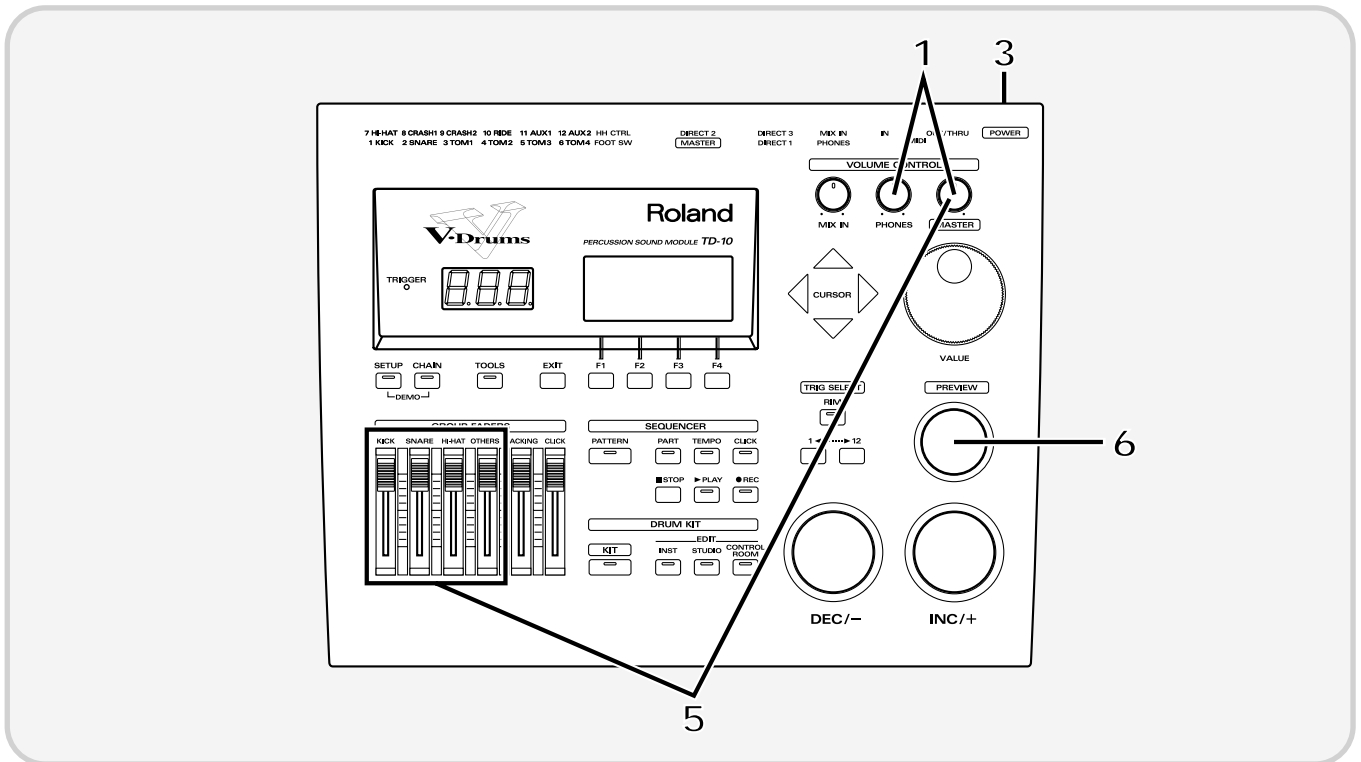

- 1 Rotate [MASTER] and [PHONES] all the way to the left to turn down the volume.
- 2 Turn down the volume of the connected amp or audio system.
- 3 Turn on the POWER switch located on the rear panel of the TD-10.

### NOTE

#### Caution when turning on the power

- After turning on the power, do not press the hi-hat control pedal (FD-7) until the drum kit name (see the following illustration) appears in the display. If the pedal was pressed while the power was being turned on, hi-hat open/close operations cannot be performed correctly.
- After turning on the power, do not strike a pad until the drum kit name appears in the display. Striking a pad while the power is being turned on will cause poor response when the pad is struck softly.



**4** Turn on the power of the connected amp or audio system.

**5** Raise the [GROUP FADERS] sliders to the maximum position, and adjust [MASTER] ([PHONES]) to the position shown in the diagram.

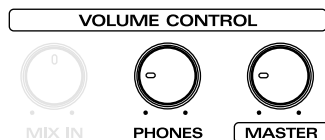

**6** While striking [PREVIEW] with your finger, adjust the volume of the connected amp or audio system. If you are using headphones, gradually raise [PHONES] to adjust the volume.

The TD-10 will produce sound. The volume will depend on the force with which you struck [PREVIEW].

**If there is no sound when you strike [PREVIEW] ...**

Check the following points.

- If you are using headphones, are they connected to the PHONES jack?
- If you are using an external amp, is it connected to the MASTER jacks? Are the audio cables connected correctly to the input jacks of the external amp, etc.?
- Could there be a problem with the cables connected to the external amp?
- Are the input select settings of the external amp correct?
- Are the [GROUP FADERS] sliders lowered?
- Could the [PHONES] volume be too low?
- Could the [MASTER] volume be too low?



*You can use [TRIG SELECT] to select and audition the instrument for each pad.*

## ■ To turn the power off ...

**1** Make sure that the TD-10 volume controls and the connected external devices are turned to the minimum position.

**2** Turn off the power of the external devices.

**3** Turn off the power of the TD-10.

## Listening to the internal demo playback

The TD-10 contains demo songs that demonstrate its sounds and expressive capabilities. The demo song is a “rainbow” of 4 short songs, arranged as a medley. It plays back in “loop” (repeating) mode, yet you can also listen, starting from any of 4 positions, accessed as follows:

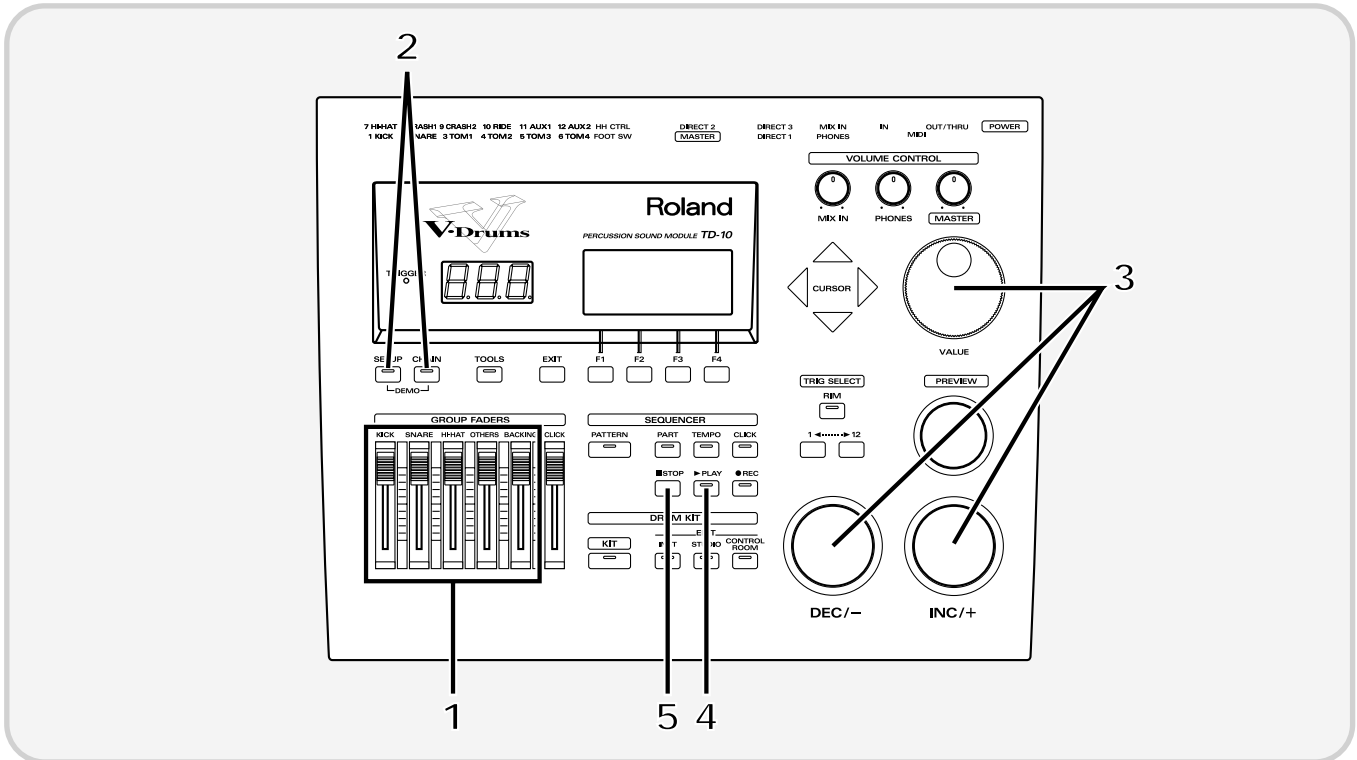

**1** Set each of the [GROUP FADERS] sliders [KICK][SNARE][HI-HAT][OTHERS][BACKING] to the same volume.

**2** Hold down [SETUP] and press [CHAIN].

In this display, the cursor defaults to “Rock.”

**3** Use [INC/DEC] or the VALUE dial to select the “section” number.

You can start listening from the beginning of any of the four sections.

**4** Press [PLAY].

You can listen to the medley and it will continue to loop.

During playback, the [GROUP FADERS] function normally allowing you to mix the demo song as you wish. (for more info on the [GROUP FADERS], see page 37.)

**5** Press [STOP] to stop playback.

Once you are through listening to the demos, press [EXIT] to return to the “DRUM KIT” page.

### NOTE

*All rights reserved. Unauthorized use of this material for purposes other than private, personal enjoyment is a violation of applicable laws.*

*No data for the music that is played will be output from MIDI OUT/THRU.*

### MEMO

*Drum kit 39–42 are used in the Demo Song.*

*For details of the Demo Song, refer to page 179.*

# Specify the pads that the TD-10 will use

In order for the TD-10 to accurately receive trigger signals from each pad, you must specify the type of pad that is connected to each TRIGGER INPUT jack.

## ■ If you have purchased the “V-Basic Kit” or “V-Standard Kit”

Trigger settings for the V-Basic Kit or the V-Standard Kit are provided, so you can call up and select them.

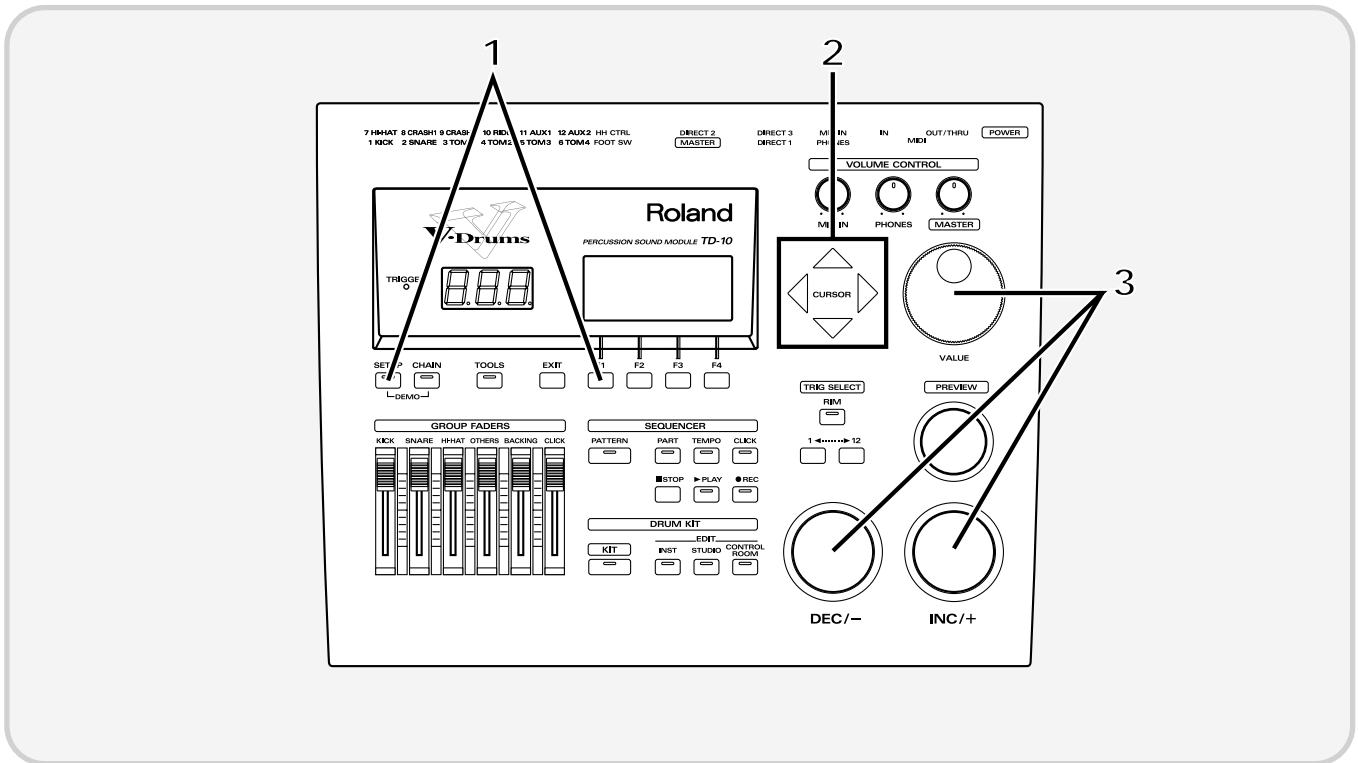

**1** Press [SETUP], press [F1 (TRIG)], and then press [F1 (BANK)].

**2** Use [CURSOR] to move the cursor to the “BANK” number.

**3** Use [INC/DEC] or the VALUE dial to make the setting.

V-Basic Kit: BANK 1

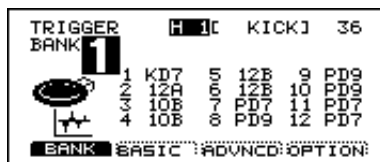

V-Standard Kit: BANK 2



### NOTE

If the settings have been modified and are different than the settings in the above diagram, use the Copy function to restore the factory settings (p. 137).

This completes settings for all pads of the V-Basic Kit or V-Standard Kit. If you are using a PD-100 or PD-120, make settings for the head tension as explained on p. 31.

Once you have completed your settings, press [EXIT] enough times to get back to the “DRUM KIT” page.

## ■ If you have purchased the PD-5, PD-7, PD-9, PD-100 or PD-120 individually

Make the following settings for each pad.

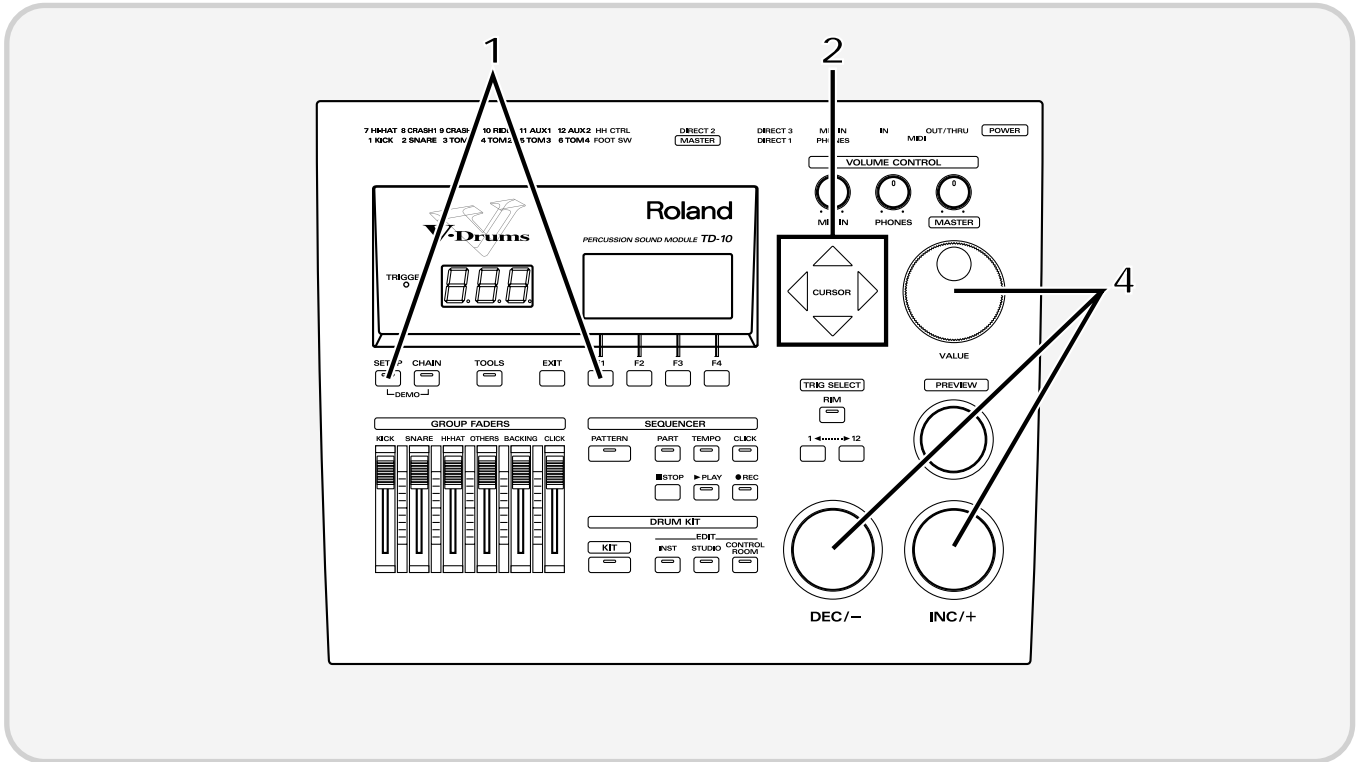

- 1 Press [SETUP], press [F1 (TRIG)], and then press [F1 (BANK)].

The following screen will appear:

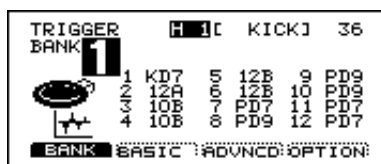

This screen shows a list of pad models that are specified for each TRIGGER INPUT jack.

Display	Pad name
PD5	PD-5
PD7	PD-7
PD9	PD-9
10A	PD-100
12A	PD-120
KD7	KD-7/KD-5

\* For details on 10B and 12B, refer to p. 108.

- 2 Use [CURSOR] to move the cursor to a location other than "BANK."

- 3 Strike the pad for which you wish to make settings.

The cursor will move to the edited value of the pad that you struck.

- 4 Use [INC/DEC] or the VALUE dial to select the model name of the pad.

This completes pad settings. If you are using a PD-100 or PD-120, make settings for the head tension as explained in the following section.

## ● Adjusting the head tension

For these pads, adjustments are required in order to regularize the tension of the head. Also, the tension of the head may change when the pad has been used for a long period. If this occurs, use the following procedure to make adjustments as necessary.

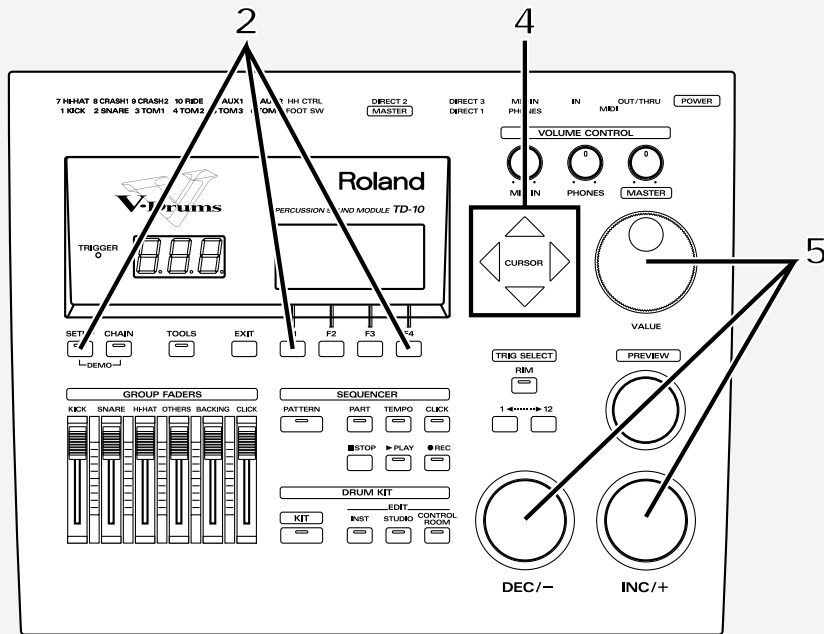

- 1** Make sure that the Trigger Type (pad model name) is set either to “10A” (PD-100) or to “12A” (PD-120).
- 2** Press [SETUP], then press [F1 (TRIG)], and then press [F4 (OPTION)].
- 3** Strike the PD-100 or PD-120 for which you wish to make settings.  
The setting page for the pad that you struck will appear.

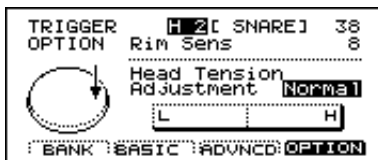

- 4** Use [CURSOR] to move the cursor to “Head Tension Adjustment.”
- 5** Use [INC/DEC] or the VALUE dial to make the setting.

With a setting of “Loose” it will be adjusted at a weaker tension, and with a setting of “Tight” it will be adjusted at a stronger tension.

For now, set this to the medium value of “Normal.”

## Before you begin playing

- 6** On the head of the PD-100 or PD-120, accurately strike a location approximately 1 inch (3 cm) from the tuning bolt.

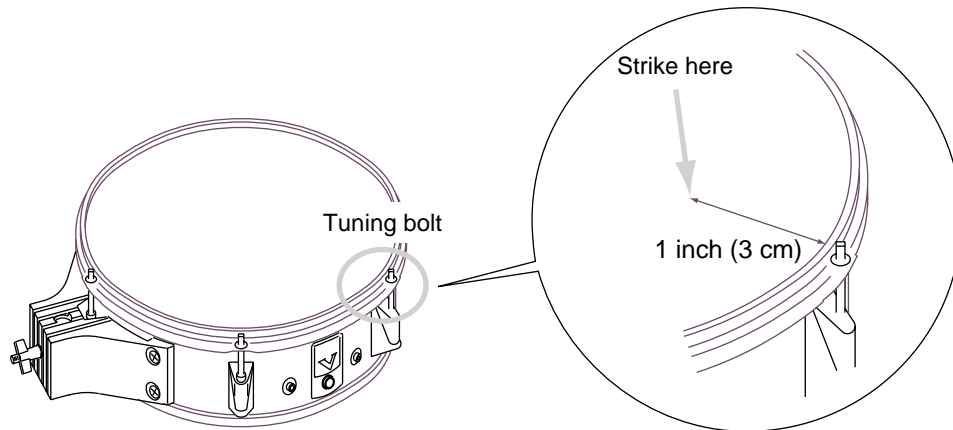

The indicator in the lower right of the display will indicate how far off the adjustment is.

- 7** Use a tuning key (optional) to turn the all tuning bolt so that the indicator reaches the position shown in the diagram.

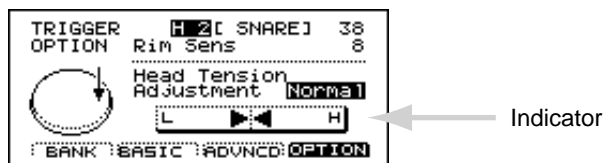

If the indicator is toward the right, turn the tuning key toward the left to loosen the tension. If the indicator is toward the left, turn the tuning key toward the right to tighten the tension.

### NOTE

*If the indicator moves greatly to the left or right, adjust the tension of the entire head before making this setting.*

*The head tension adjustment does not work correctly when the "SCAN TIME" (p. 111) setting is excessively low. The "SCAN TIME" setting is automatically set to the most efficient values for each pad when you select the "TRIGGER TYPE" (P.108). If you have changed the "SCAN TIME" setting, select the "TRIGGER TYPE" again.*

### MEMO

*For details on adjusting the head tension, refer to the PD-100/120 owner's manual.*

Once you have completed your settings, press [EXIT] enough times to get back to the "DRUM KIT" page.





## Check the settings

This completes the settings. Strike the pads/drums and verify that the appropriate instrument sounds correctly. If not, check the settings once again, and refer to “Troubleshooting connections and settings” on p. 45.

# For a better performance

## Concerning the performance & expressiveness of the pads

This section introduces various performance functions that will help you perform more expressively on the pads.

Some of these playing techniques and functions are unique to the TD-10, so please be sure to read this section in order to take full advantage of the TD-10's capabilities.

### ■ Rim shots

By using the rim, you can play two types of sound from one pad. This can be done with a PD-7, PD-9 and PD-120.

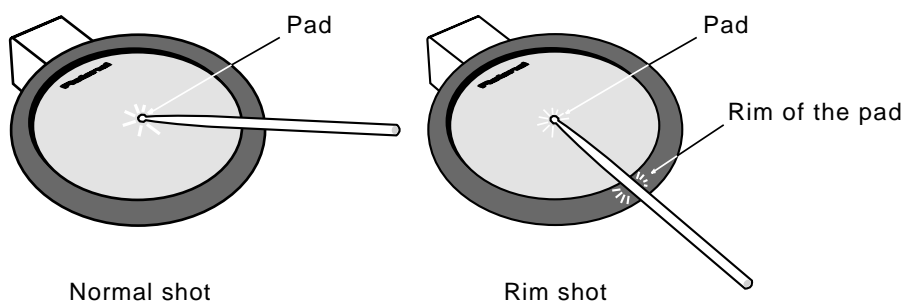

To play a rim shot, you must strike both the head (center area) and the rim (outer edge) of the pad simultaneously. There will be no sound if you strike only the rim. When you play a rim shot, the instrument assigned to the rim will sound.

#### NOTE

*When specifying the rim during editing, you will also need to strike the head and rim simultaneously.*

**Important:** The rim function of the PD-120 ONLY works when connected to trigger input 2 (SNARE). If you desire rim sounds for the toms etc., please use a PD-7 or PD-9.

### ■ Choking

This function simulates the muting of a cymbal and can be done with a PD-7 or PD-9.

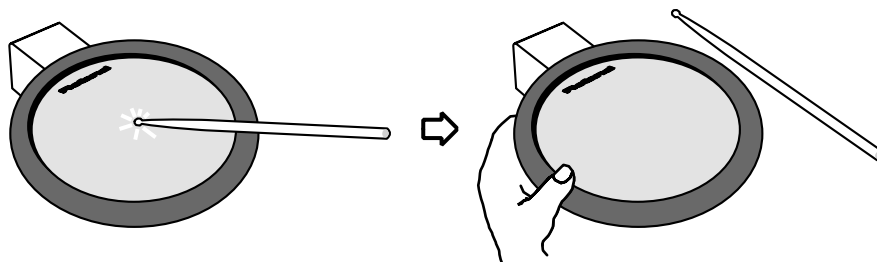

By striking a pad and then squeeze the rim portion of the pad while the note is still sounding, you can mute the sounding note; a performance technique known as choking.

## ■ Positional sensing

This function simulates movement across the snare drum head or ride cymbal surface. A PD-7, PD-9, PD-100 or PD-120 can be used when connected to trigger jacks number 2 or 10.

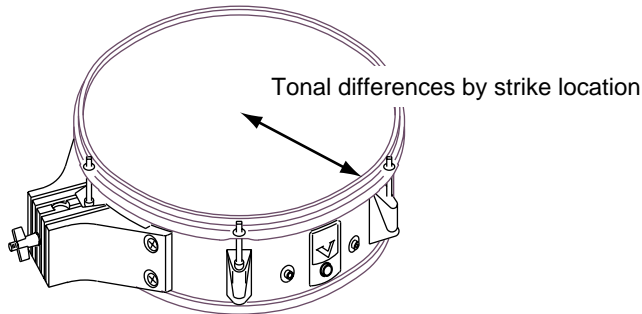

For the snare drum and ride cymbals, differences in striking position between the center of the head and the rim area will produce a natural change in tone. When the PD-120 is used as a snare, changes in tone and response will produce playability rivaling that of an acoustic drum.

## ■ Playing with brushes

The TD-10 allows you to play using brushes when using a PD-100 or PD-120 only. You can use techniques such as swishing or sweeping to trigger that type of sound, as with an acoustic drum. When using brushes, you must select a drum kit that is intended for brush playing. Press [KIT], and select a kit that has a symbol like the following at the lower right of the kit name.



### NOTE

*ONLY use nylon/plastic brushes. Metal brushes will damage the head and/or could pierce the fine mesh of the head itself.*

### MEMO

*Of the preset drum kits, numbers 7 and 37 are for brush playing.*

## ■ Hi-hat control pedal

A hi-hat control pedal can be used for the following performance techniques, giving you continuous control from open to closed positions. This can be done with an FD-7.

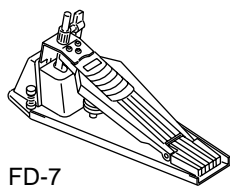

- Open hi-hat: Strike the pad without pressing the pedal.
- Closed hi-hat: Strike the pad while pressing the pedal.
- Pedalled closed: Step on the pedal to trigger the "foot close" hi-hat.
- Pedalled open: Step on, and quickly release pedal to trigger the "foot open" hi-hat sound.

## TD-10 operating procedure

This section explains basic operation of the TD-10. Please try out each of these procedures.

### ■ Adjusting the volume

#### Adjusting the volume balance

For the kick drum, snare drum and hi-hat, use the [GROUP FADERS] sliders to adjust the volume. Tom and cymbal, etc. are all adjusted as a group by [OTHERS].

Volume adjustments for each pad of the kit are made by the Control Room settings (p. 90).

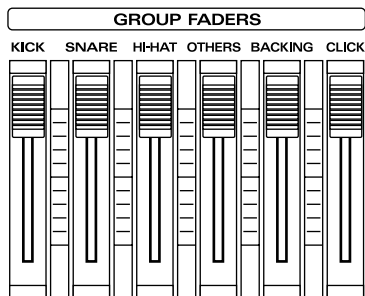

#### Adjusting the overall volume

Use [VOLUME CONTROL] to adjust the volume of the TD-10's MASTER output jacks. Rotating it clockwise increases volume, and rotating it counterclockwise decreases volume.

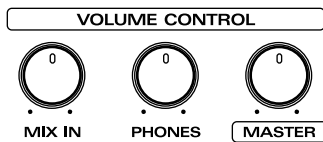

[MASTER]: Adjusts the volume output from the MASTER OUT jacks.

[PHONES]: Adjusts the volume output from the headphone jack.

[MIX IN]: Adjusts the volume that is input from the MIX IN jack.

The input from MIX IN is output from the MASTER jacks and the PHONES jack (alternatively, only from the PHONES jack).

## ■ Selecting a drum kit

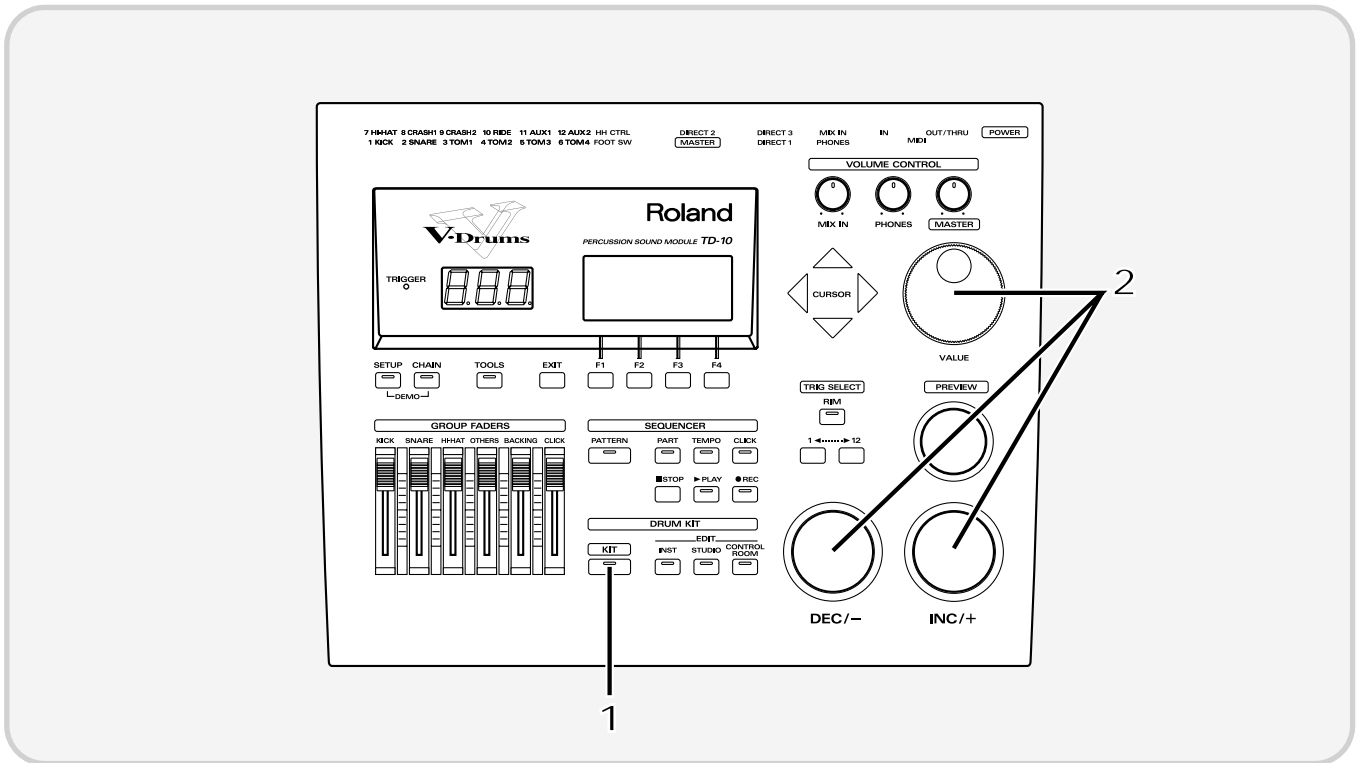

**1** Press [KIT].

The following screen will appear:



Each drum kit of the TD-10 is a collection of settings for the instrument assigned to each pad, settings for the room and microphones, mixer, effects and other parameters.

**2** Use [INC/DEC] or the VALUE dial to select a kit.



*The List display makes it easier to select a drum kit. In the above display, press [F1 (LIST)], and ten kit names will appear in one screen, allowing you to select the desired kit. Press [F1 (PAGE <)] to move to the previous page, or [F2 (PAGE >)] to move to the next page. In this display, you can select kits using [INC/DEC], the VALUE dial, or [CURSOR].*

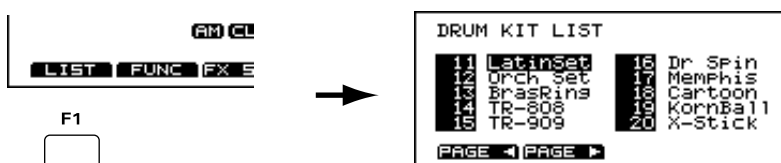

Press [EXIT] to return to the display page of step 1.

## ■ Adjusting the sensitivity of a pad

You may wish to adjust the sensitivity of the pads to accommodate your personal taste. In this section we will explain the easiest way to adjust the TD-10's sensitivity in order to get the best correlation between your playing velocity (strength) and the response and volume of the sound.

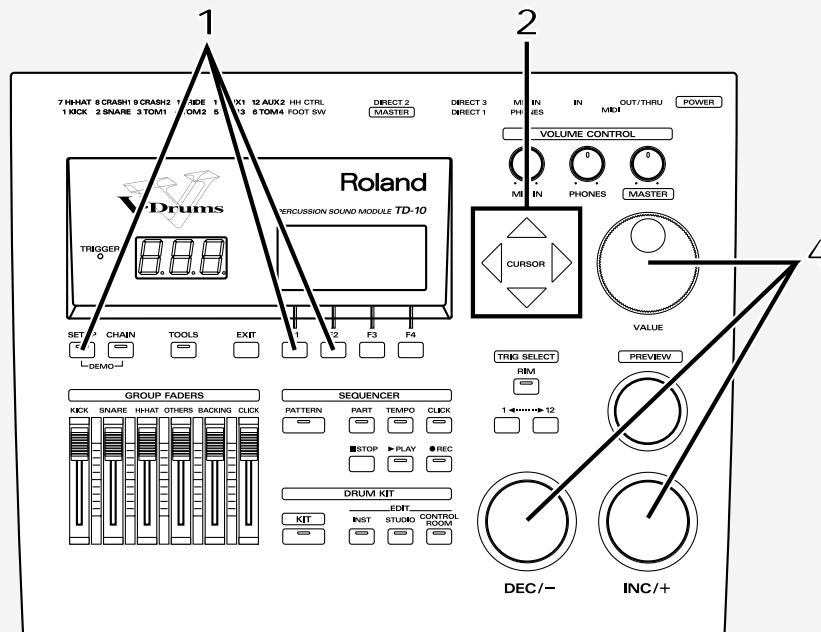

- 1 Press [SETUP], then press [F1 (TRIG)], and then press [F2 (BASIC)].

The following screen will appear:

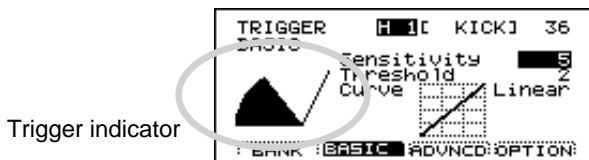

- 2 Use [CURSOR] to move the cursor to "Sensitivity."
- 3 Strike a pad to select the one needing sensitivity adjustment.
- 4 Use [INC/DEC] or the VALUE dial to adjust the sensitivity.

The numeric value at the cursor will change (within the range from 1 to 16). Lower sensitivity (lower values) will mean that stronger strikes will not increase the volume very much. Conversely, higher sensitivity will mean that loud volumes will be reached quickly as you play more strongly. In general, it is best to set the sensitivity so that the indicator reaches the maximum position when you play with your maximum dynamics.

### NOTE

Overall volume is an important element in adjusting the sensitivity of an electronic drum kit. In particular, if you are listening at a low volume you may feel that there is too little change in volume, so you might raise the sensitivity excessively without really needing to. Try playing at different volume levels (through amps or headphones) in order to fine tune the sensitivity. In order to make settings correctly, adjust the volume to an appropriate level.

## ■ Master equalizer

This is the master equalizer that is applied to the sound output from the MASTER OUT jacks. It adjusts the balance of the low, mid, and high frequency ranges. Let's try adjusting the GAIN (the amount of boost).

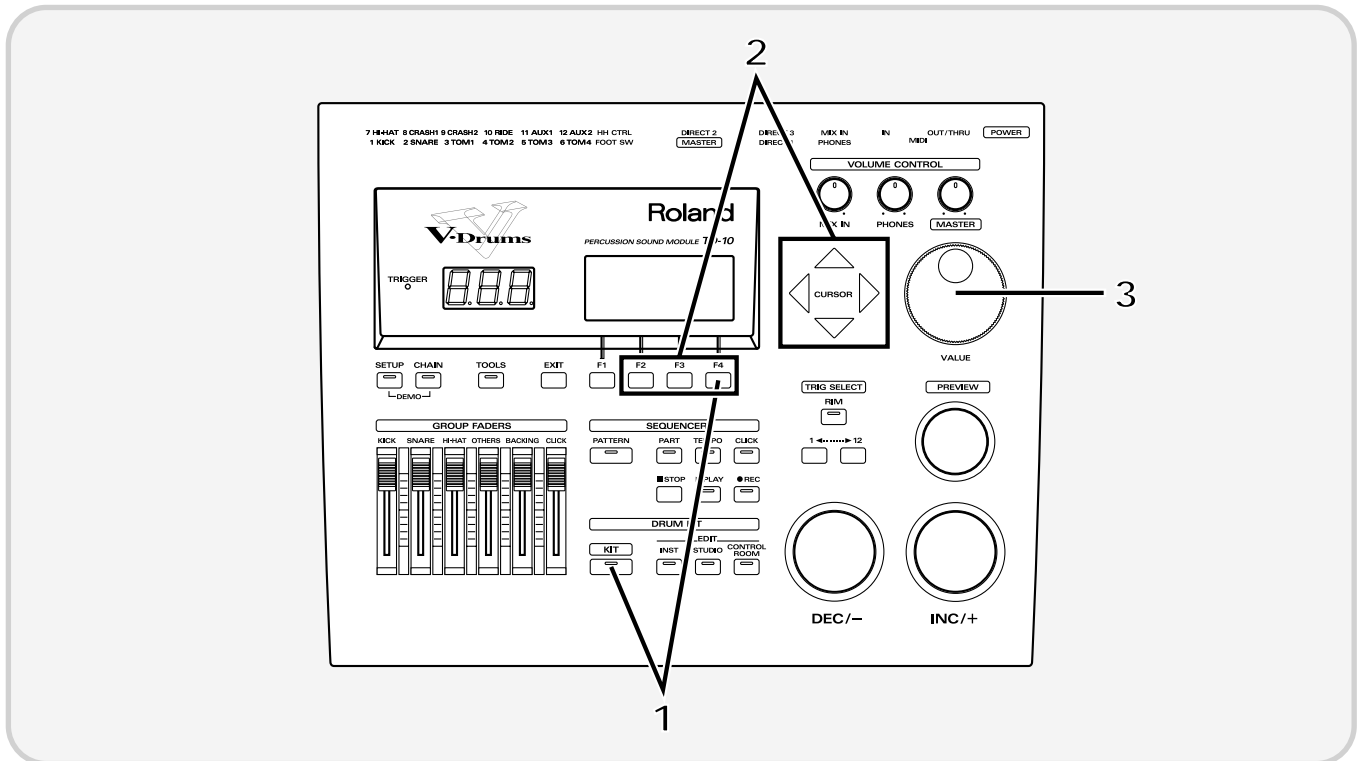

- 1 Press [KIT], and then press [F4 (MAS EQ)].

The following screen will appear:

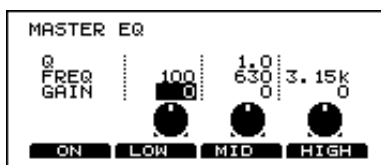

- 2 Use [F2]–[F4] or [CURSOR] to select the “GAIN” column.

[F2]: Low range (LOW)  
[F3]: Middle range (MID)  
[F4]: High range (HIGH)



[F1] functions as an equalizer on/off switch.

- 3 Use the VALUE dial to modify the value, and hear how the sound changes.

Press [EXIT] to return to the “DRUM KIT” display page.



## ■ Effect on/off

If you wish to compare your sounds “with” or “without” ambience, individual compressors & equalizers, or digital effects, here they can each be turned on/off for the entire kit.

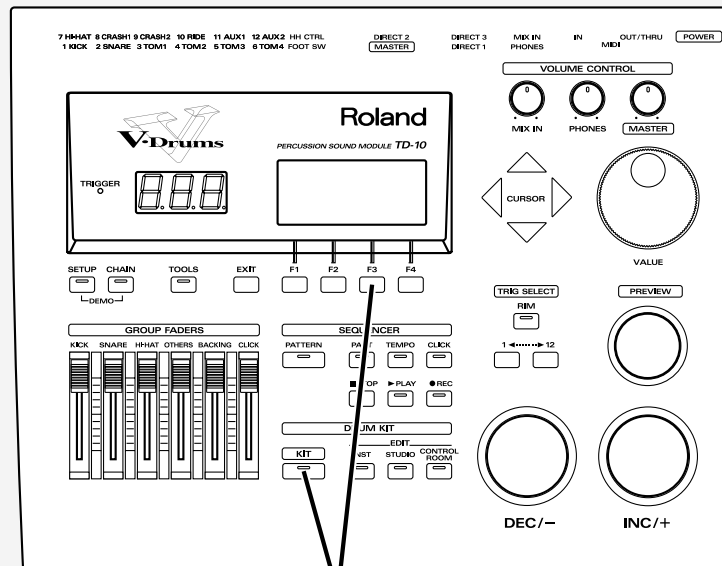

1

- 1 Press [KIT], and then press [F3 (FX SW)].

The following screen will appear:

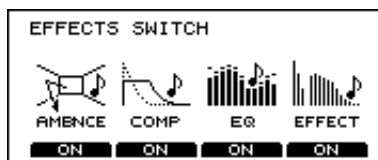

In this page, [F1]–[F4] act as on/off switches. For example, pressing [F1] will turn ambience on/off.

**AMBNCE (Ambience):** The size of the room and the type of walls can be adjusted to modify the sound.

**COMP (Compressor):** This is used to smooth volume peaks, preventing overload.

**EQ (Equalizer):** This adjusts the balance of the high, mid and low ranges.

**EFFECT (Effect):** This adds effects such as reverb or delay.

### NOTE

*When these switches are turned off, effects will not apply, regardless of any other settings. Before using ambience or effects, make sure that these switches are turned on.*

### MEMO

*These settings can be made for each drum kit.*

Press [EXIT] to return to the “DRUM KIT” display page.

## ■ Help function

You can select a keyword for a specific operation and instantly view an explanation or the relative setting page. For example if you wish to make settings for a function using a foot switch, select the “FOOT SWITCH” keyword and press the button to access the appropriate setting page.

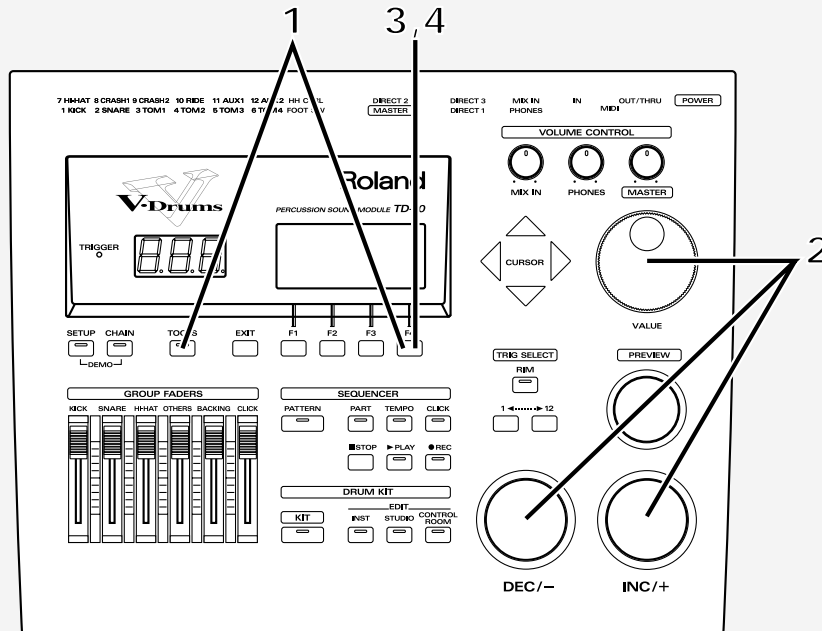

**1** Press [TOOLS], and then press [F4 (HELP)].

The following screen (keyword list) will appear:



**2** Use [INC/DEC] or the VALUE dial to select a keyword.

**3** Press [F4 (SELECT)], and an explanation of the function will appear.

**4** If you wish to go to the setting page for that function, press [F4 (GO NOW)].

Once you have completed your settings, press [EXIT] enough times to get back to the “DRUM KIT” page.

## About expansion boards

Expansion boards (optional) are cards that allow you to upgrade the system and add new instruments and drum kits.

\* *Sound expansion boards for the Roland JV/XP series cannot be used.*

The bottom panel of the TD-10 has a slot that allows expansion boards to be installed.

Install only the specified circuit board(s) (WAVE & SYSTEM EXPANSION BOARD TDW series).

1. Always turn the TD-10 off and unplug the power cord before attempting installation of the circuit board (WAVE & SYSTEM EXPANSION BOARD TDW series).
2. Remove only the four screws as indicated below, and open the cover located on the bottom of the TD-10.

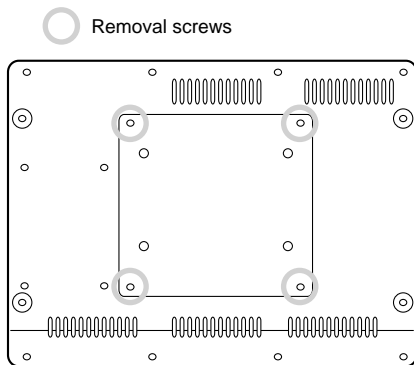

3. Check that the plastic board holders are positioned as shown figure. Rotate them if necessary.

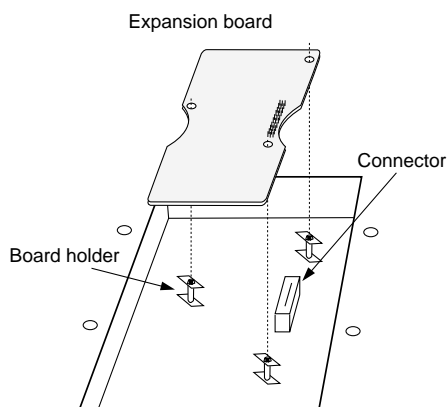

4. While positioning the holes on the board over the board holders, carefully insert the connector on the board into the socket on the TD-10. Make sure the connector is securely connected, and that all three board holders project through the holes.

\* *Do not touch any of the printed circuit pathways or connection terminals.*

\* *Never use excessive force when installing a Expansion Board. If it doesn't fit properly on the first attempt, remove the board and try again.*

5. Use the Installation Tool supplied with the Expansion board to turn the holders in the LOCK direction, so the board will be fastened in place.

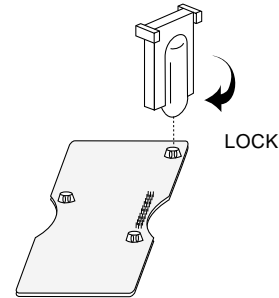

\* *When Expansion Board installation is complete, double-check your work.*

(To remove the Expansion board, turn the board holders in the UNLOCK direction, and lift up the board using the provided tool. Remove the board and secure the cover plate.)

6. Secure the cover plate using the four screws removed in step 2.

### ⚠ WARNING

- Immediately turn the power off, and request servicing by your dealer or qualified Roland service personnel when:
  - Objects (such as screws) have fallen into, or liquid has been spilled on to the TD-10; or
  - The TD-10 has been exposed to rain (or otherwise has become wet); or
  - The TD-10 does not appear to operate normally or exhibits a marked change in performance.

Never open the bottom cover of the TD-10 by yourself.

- To avoid the risk of damage to internal components that can be caused by static electricity, please carefully observe the following whenever you handle the board.
  - Before you touch the board, always first grasp a metal object (such as a water pipe), so you are sure that any static electricity you might have been carrying has been discharged.
  - When handling the board, grasp it only by its edges. Avoid touching any of the electronic components or connectors.

## À propos des cartes d'extension (French language for Canadian Safety Standard)

Les cartes d'extension (optionnelles) sont des cartes qui vous permettent d'augmenter la puissance de votre système et d'ajouter de nouveaux instruments ainsi que des batteries.

\* Les cartes d'extension de son pour les séries JV/XP de Roland ne peuvent être utilisées.

N'installez que la ou les carte(s) de circuits imprimés spécifiée(s). (WAVE & SYSTEM EXPANSION BOARD série TDW)  
Le panneau du dessous du TD-10 a un créneau permettant l'installation des cartes d'extension.

1. Éteignez toujours le TD-10 et débranchez le câble électrique avant toute tentative d'installation de carte de circuits imprimés (WAVE & SYSTEM EXPANSION BOARD série TDW).
2. Enlevez seulement les quatre vis et ouvrez la plaque située sous le TD-10.

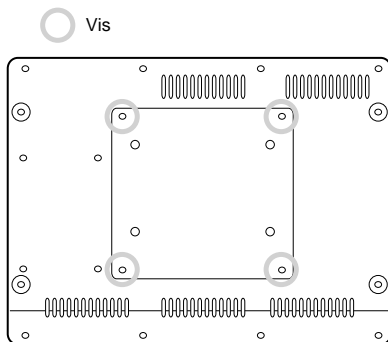

3. Veillez à ce que les supports en plastique pour la carte soient positionnés tel qu'indiqué. Faites-les pivoter si nécessaire.

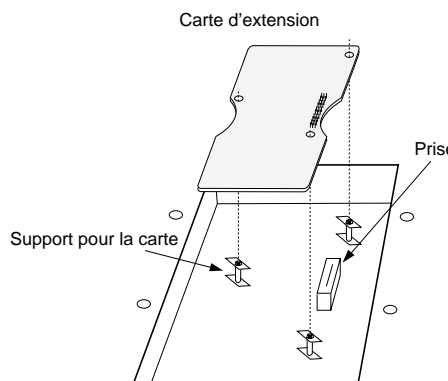

4. Pendant que vous alignez les trous de la carte au-dessus des supports, insérez délicatement le connecteur sur la carte dans la prise du TD-10. Assurez-vous que le connecteur est raccordé correctement et que les trois supports s'emboîtent bien dans les trous.

\* Ne touchez pas à la carte de circuits imprimés ni à aucun des terminaux de connexion.

\* Ne forcez jamais excessivement lors de l'installation d'une carte d'extension. Si elle ne s'ajuste pas correctement au premier essai, enlevez-la et recommencez.

5. Pour tourner les supports en position LOCK (verrouillé), utilisez l'outil d'installation de la carte d'extension fournie à cet effet. De cette façon, la carte sera bien fixée à sa place.

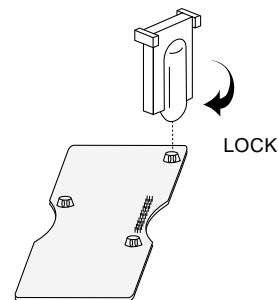

\* Lorsque votre installation de la carte d'extension est terminée, vérifiez-la.

(Pour enlever la carte d'extension, faites tourner les supports dans la direction UNLOCK (déverrouillé) et soulevez la carte en utilisant l'outil à cet effet. Retirez la carte et remettez la plaque.)

6. Refermez la plaque en utilisant les quatre vis enlevées à l'étape 2.

### ⚠ AVERTISSEMENT

- Éteignez immédiatement l'unité, et contactez le SAV de votre revendeur ou un service de maintenance Roland qualifié lorsque  :
  - Des objets (vis) sont tombés dans l'unité ou du liquide s'est répandu à l'intérieur
  - L'unité a été exposée à la pluie (ou d'une façon ou d'une autre a été mouillée)
  - L'unité ne semble pas fonctionner normalement ou montre une altération de ses performances.

N'ouvrez jamais vous-même le capot du dessous du TD-10.

- Pour éviter d'endommager les composants internes par de l'électricité statique, suivez attentivement les règles ci-dessous lorsque vous maniez la carte.
  - Avant de toucher la carte, saisissez toujours un objet métallique (tel qu'un tuyau d'arrivée d'eau) pour être sûr de vous décharger de toute électricité statique.
  - Quand vous saisissez la carte, ne la prenez que par ses côtés. Évitez de toucher ses composants électroniques ou connecteurs.

## Troubleshooting connections and settings

This section will discuss points to check if you experience problems while making basic settings, and how to solve those that occur easily when you are using electronic drums for the first time.

### NOTE

Before checking or modifying connections, be sure to turn off the power of all devices.

### MEMO

For troubleshooting of problems that occurred as a result of editing operations, etc., you will need to check your editing, so please refer to "Troubleshooting" (p. 132) in the "Appendices." Also refer to that section if you are using acoustic drums to trigger the TD-10, or if you are using pads made by a manufacturer other than Roland.

### ■ No sound

First, make sure that connections have been made according to the setup on p. 23–25, and then check the following points.

#### ● No sound when you strike [PREVIEW]

Make sure that the [GROUP FADERS] sliders are not lowered.

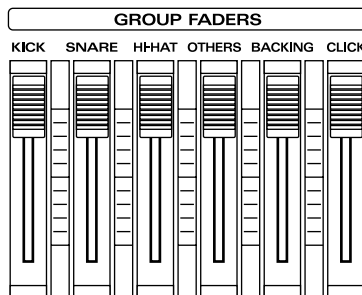

#### ● [PREVIEW] produces sound, but striking the pads does not.

Check whether the trigger indicator (TRIGGER) lights when you strike a pad. If it doesn't light, check the connections of the pad and TRIGGER INPUT jack.

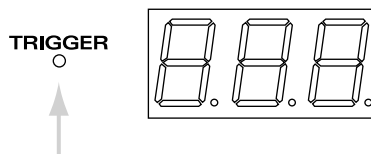

#### ● You hear sound in the headphones but not from the external amp, etc.

Check the connections with the external equipment, its volume, and make sure that the TD-10's [MASTER] knob is not turned down.



### ■ The wrong pad sounds, or other pads sound inadvertently

- Are you using the wrong TRIGGER INPUT jacks?
- Are the pads fixed firmly in place?

If the attachment of a pad has loosened, it may receive vibrations when a different pad is struck, and trigger sounds unintentionally.

- Is a high-volume speaker sounding nearby the pad? Try changing the orientation of the speaker or the pad.

### ■ When a pad is struck softly, it does not sound

- Did you touch a pad or press a pedal from the time that the TD-10 was powered on until the kit name display appeared?

When the power is turned on, the TD-10 checks the pads. If pads are struck during this time, the check cannot be performed correctly.

### ■ The volume is too small for the force with which the pads are struck

- Are you listening at an appropriate volume? In the case of electronic drums, listening at low volumes may give you the impression that the pad sensitivity is low. If raising the volume (p. 37) does not correct this, then try adjusting the sensitivity (p. 39).

### If you are using a PD-5, PD-7, PD-9, PD-100 or PD-120

You can make adjustments for the volume produced relative to the playing velocity (striking force) on the pad. Refer to p. 39 and try making this adjustment.

## If you are using pads made by another manufacturer

If when using pads made by another manufacturer, they do not perform satisfactorily, you will need to adjust the trigger parameters. Refer to “Basic settings for the trigger parameters (BASIC)” (p. 109) in the “Advanced Use,” and make the needed changes or settings.

### ■ Specific pads are too loud or too soft

- If you are listening in monaural, use the MASTER L (MONO) jack ONLY, and do not insert a plug into the R jack.
- Are each of the [GROUP FADERS] sliders in an appropriate position?  
Move all the faders to the same volume, then re-adjust for the desired balance.

### ■ Rim shots do not sound

- Are you using a PD-7, PD-9 or PD-120 pad?  
Rim shots cannot be played on other pads.
- Are you using a monaural cable to connect the pad with the TD-10?  
If so, only the head portion will trigger sound. Use the stereo cable included with the PD-7, PD-9 or PD-120.
- Are the trigger type settings correct?

### ■ Rim shots do not sound correctly

- When playing on the PD-7 or PD-9, strike the rim and head simultaneously. Simply striking the rim alone will not produce sound.
- Are the trigger type settings correct?
- If you are using a PD-120 as the snare, check the “Rim Sensitivity” setting (p.110).

### ■ Volume is low when you play using brushes

- Since the impact of a brush is lower than the impact of a stick, you need to use a drum kit that has trigger settings geared for brushes, one displaying a symbol such as the following in the lower right of the KIT display page.



### ■ Strike location is not detected.

- Are the trigger type settings correct?
- When using a PD-100 or PD-120, is the head tension adjusted correctly?
- When using a PD-7 or PD-9, is the Polarity Switch set to “-(Roland)”?
- Strike location can be detected only for trigger number 2 (SNARE) and trigger number 10 (RIDE).

# Features of the preset drum kits

## How sounds are created on the V-drums

The TD-10 uses a completely new method for generating sounds called Variable Drum Modeling. The concept of this method is to “model” the important parts or “character” that makes a drum sound the way it does. This allows editing of parameters that were never available before, thus creating new and personalized sounds.

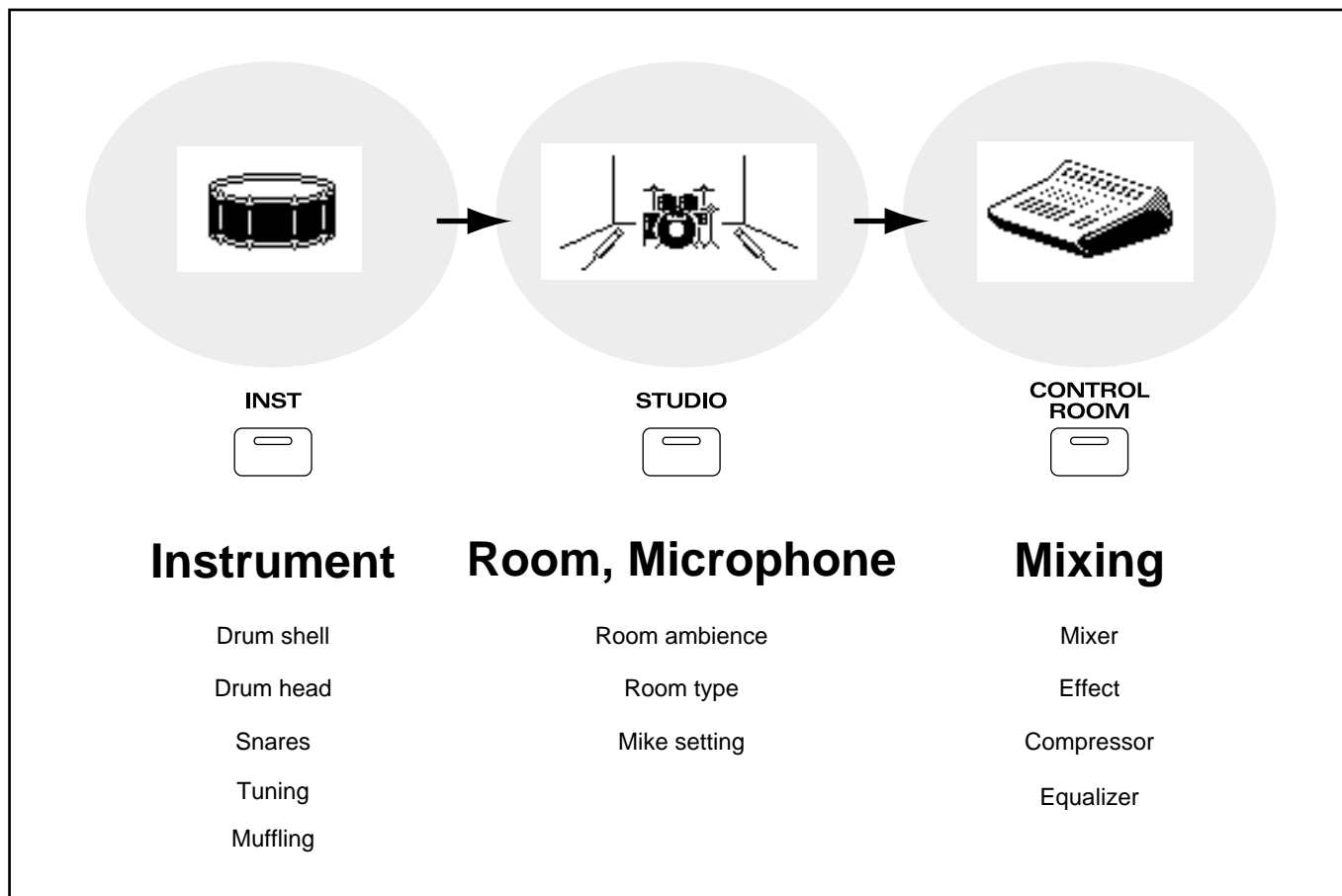

### 1. Instrument (INST)

The materials that make up the drums, their shape, and other elements.

### 2. Studio (STUDIO)

The type, size and construction material of the room in which the drums are played, positions of the ambient mikes, and the type and position of the microphones used to pick up the instruments.

### 3. Control room (CONTROL ROOM)

Here, the finishing touches are made by changing mixer settings such as volume/pan/effect send level/output assignment/EQ/Compressors and digital effects.

The V-drums concept focuses on these three major areas and three dedicated buttons [INST], [STUDIO] and [CONTROL ROOM] are provided for quick access so your creative aspirations can be immediately translated into reality. As an interface concept for the user, this is also completely new.

Before you actually begin creating sounds, please read the following explanations of some of the preset drum kits. They will lead you through some easy steps to become familiar with the features of an acoustic kit, a kit for brushes, and an electronic kit.

## No.36: 70's Rock drum kit

This is a rock drum kit with a deep and “fat” sound. Until now, this type of “fatness” could never be created or edited in drum modules or samplers. However, since the TD-10 uses a model of an acoustic drum that can be adjusted using the Variable Drum Modeling technology, you can create a sound of your own and one that responds to your natural dynamics.

Let's take a look at the instrument parameters of this kit. One of the parameters that creates the richness of the sound is “Shell Depth” (which adjusts the depth of the drum shell). Let's experiment by changing the shell depth of the snare drum.

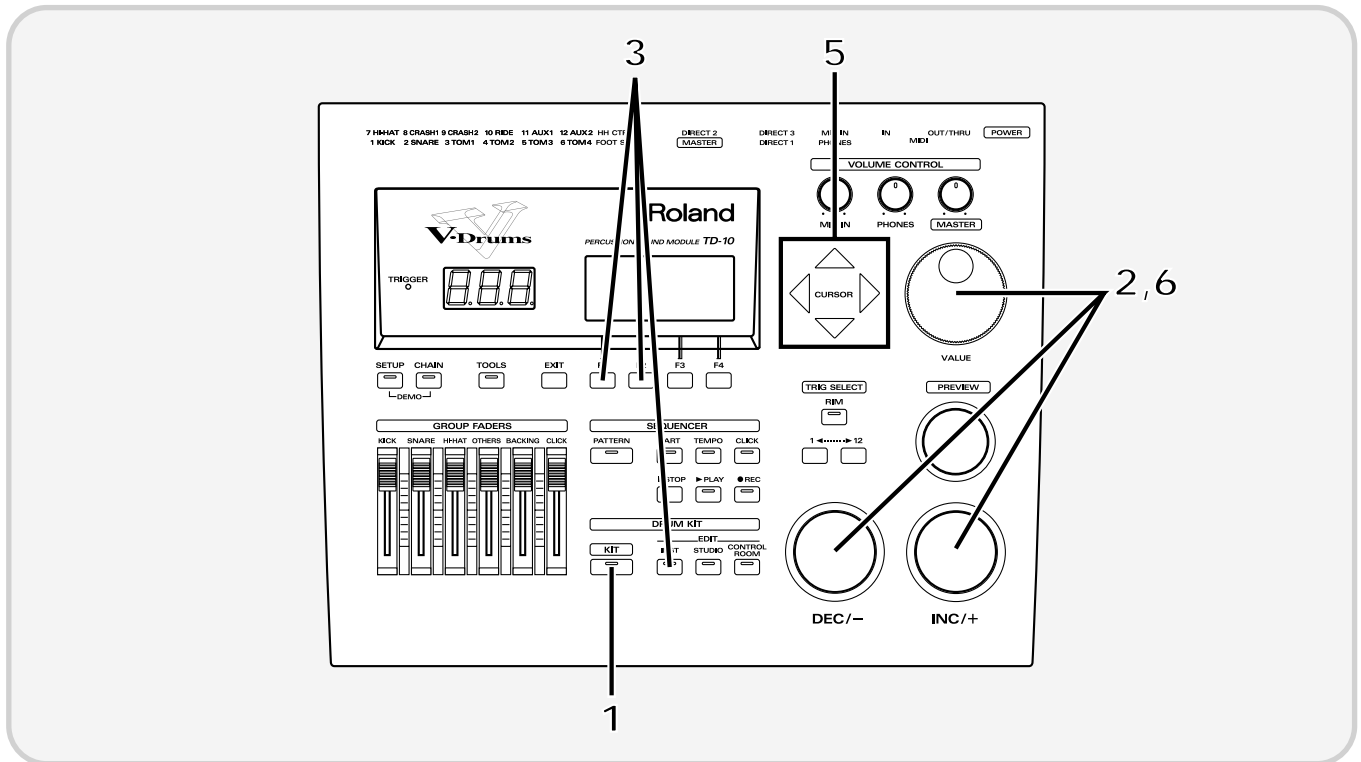

**1** Press [KIT].

The “DRUM KIT” page will appear.

**2** Use [INC/DEC] or the VALUE dial to select kit number 36.





- 3** Press [INST], then [F2 (EDIT)], and then press [F1 (SHELL)].

The following screen will appear:



- 4** Strike the pad that you are using as the snare.

The snare settings display page will appear. In this page you can select the materials and depth of the drum shell.



- 5** Use [CURSOR] to move the cursor to "Shell Depth."



- 6** Use [INC/DEC] or the VALUE dial to change the depth of the shell.

In order to produce a powerful sound, this preset has a setting of 8.0 inches, but let's try changing this to 3.5 inches.

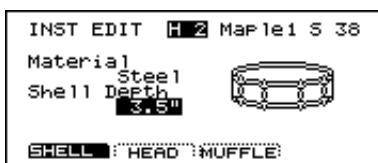

How does it sound? The character has changed considerably, and is much lighter. Strike a tom pad, and try the same adjustment for it.

In order to make the same comparison on acoustic drums, you would use two separate drums. Furthermore, previous models of electronic drums had no way to make this adjustment. However on the TD-10, such changes are made with simple front panel operations, letting you create the desired sound in an instant.

## No.37: Brush Kit

This is a kit for playing with brushes, something that was also not possible with any previous electronic drum system. Compared with stick playing, brush playing uses an extremely delicate trigger signal, so we have provided a kit with special trigger settings. The studio and control room settings are set to take advantage of this delicate character, and emphasize a natural feeling as if the kit were being played right in front of the listener. Listen to what the effect settings are doing. To avoid destroying the nuances of the original sound, effects are being used subtly, and do create a significant impact on the resonance and tone of the delicate sounds.

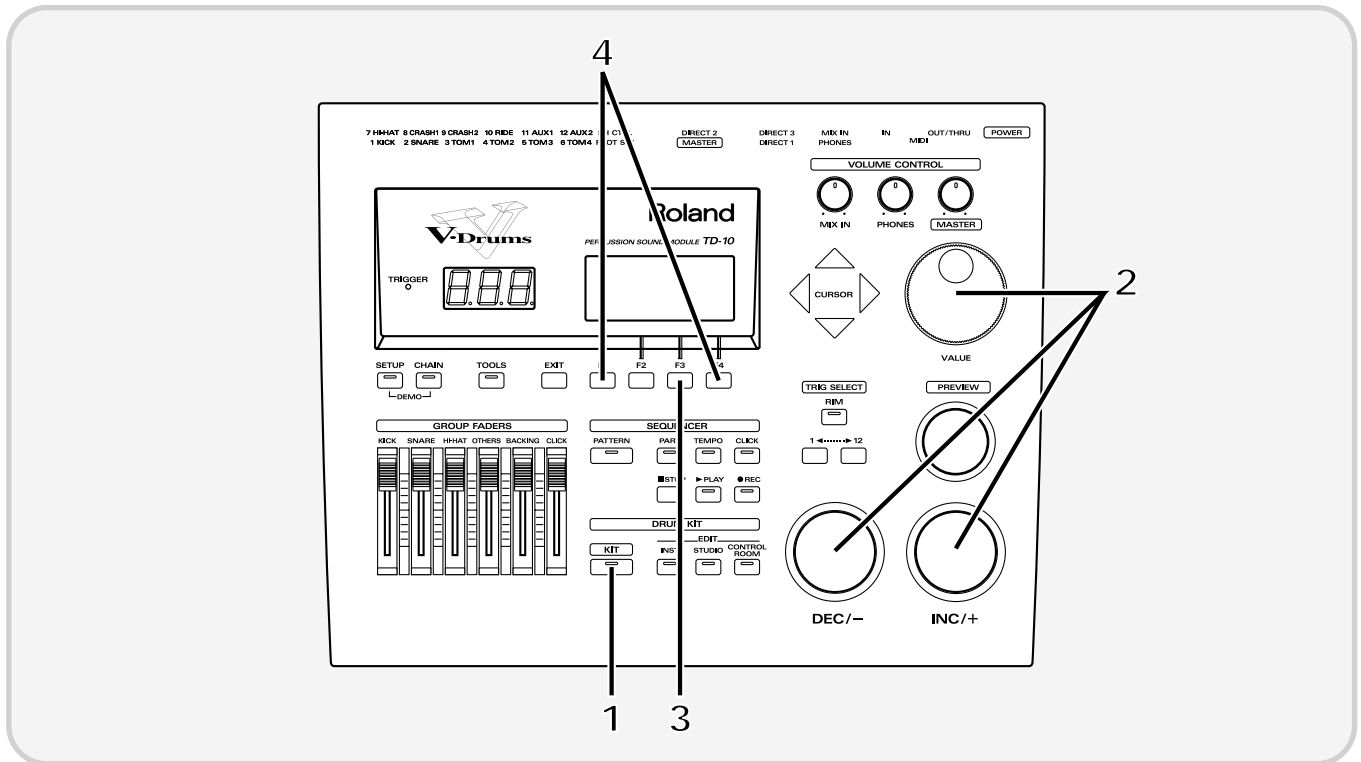

**1** Press [KIT].

The “DRUM KIT” display page will appear.

**2** Use [INC/DEC] or the VALUE dial to select kit number 37.



### 3 Press [F3 (FX SW)].

The following screen will appear:

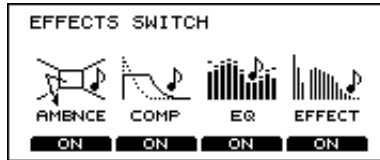

An indication of “ON” appears above each button [F1]–[F4], indicating that all effects are being used.

### 4 Press [F1] and [F4].

Ambiance and Effect will be turned off.

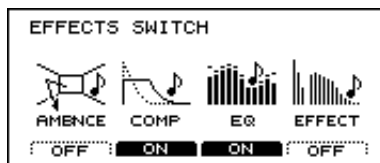

How does it sound? You will notice that the sound has suddenly lost its sense of depth.

Sounds that have a pronounced delicate character respond very sensitively to ambience and reverberation. In more advanced applications of these settings, you can control the character of ambience and reverb to simulate the exact acoustic space that you have in mind; for example, a “live” and “spatial” character, while at the same muting some of the resonance.

## No.38: Electronic drum kit

With this kit we can reproduce the electronic drums that were popular in the early 1980's. Previous drum sound modules did not provide for the creation and editing of the unique parameters of an electronic drum. Since the TD-10 provides these parameters and also reproduces tonal changes resulting from changes in velocity (striking force), it gives us powerful electronic sounds with great potentials in today's dance, hip-hop and rap music scenes.

Let's experiment by changing the amount of pitch bend, a function that modifies pitch during the decay (duration) of the sound, and is one feature that characterizes an electronic drum. The pitch bend parameter specifies the amount of pitch change.

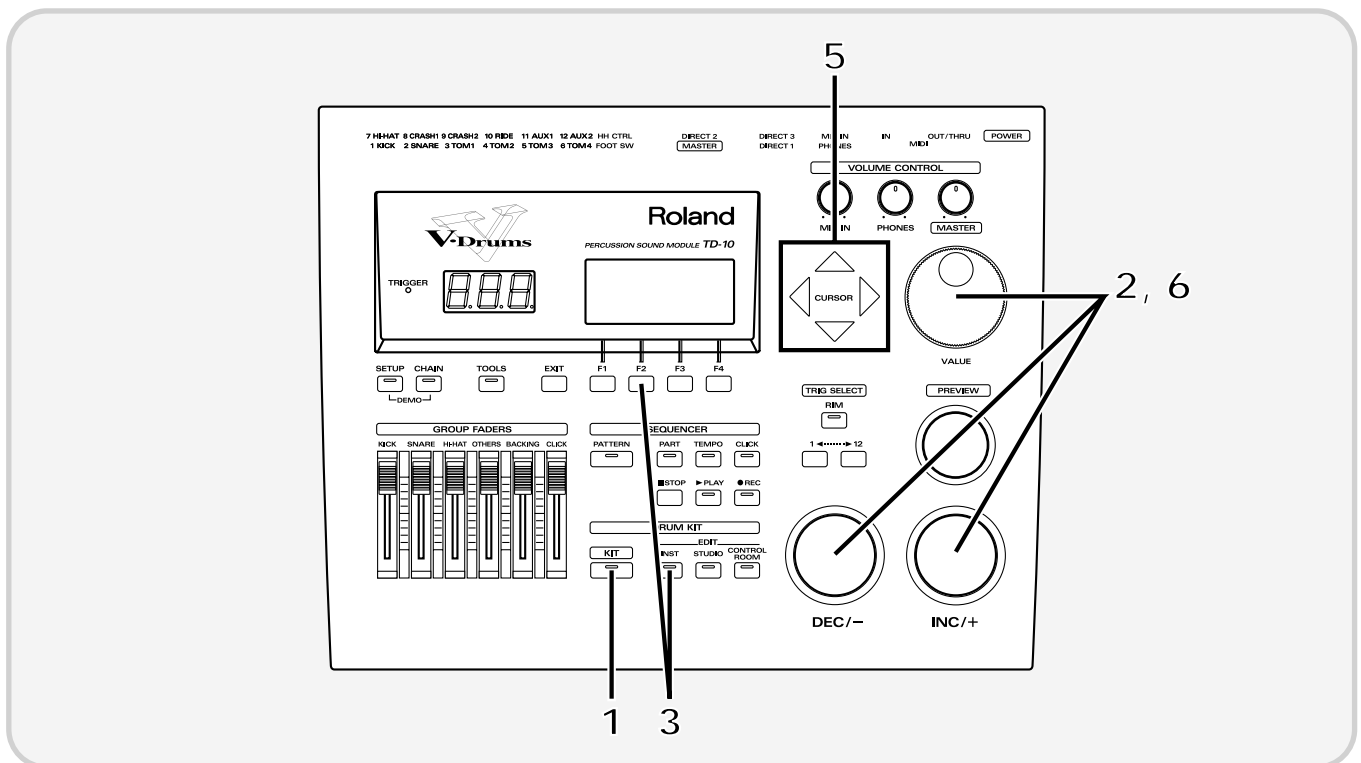

**1** Press [KIT].

The "DRUM KIT" page will appear.

**2** Use [INC/DEC] or the VALUE dial to select kit number 38.



**3** Press [INST], and then press [F2 (EDIT)].

The following screen will appear:



**4** Strike the pad that is being used as the tom.

The tom setting screen will appear.

**5** Press [CURSOR] to move the cursor to "Bend."

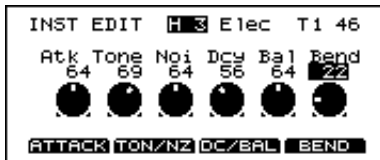

**6** While using [INC/DEC] or the VALUE dial to increase the pitch bend setting, strike the tom pad.

The pitch at the beginning of the note will become higher, and the effect will gradually become more intense.

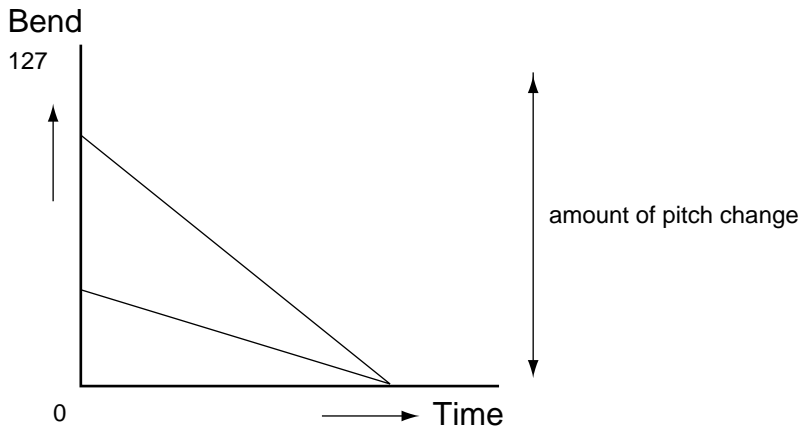

# Modifying a drum kit

In this section we will start with drum kit number 36, and take you through the process of creating an entirely different kit. Kit number 36 is a distinctive kit intended for rock, but we will turn this into a sharper and more natural-sounding drum kit that might be suitable for fusion, etc. When effects are being used, it will be difficult to hear how the instruments really sound, so let's begin by turning off all the effects.

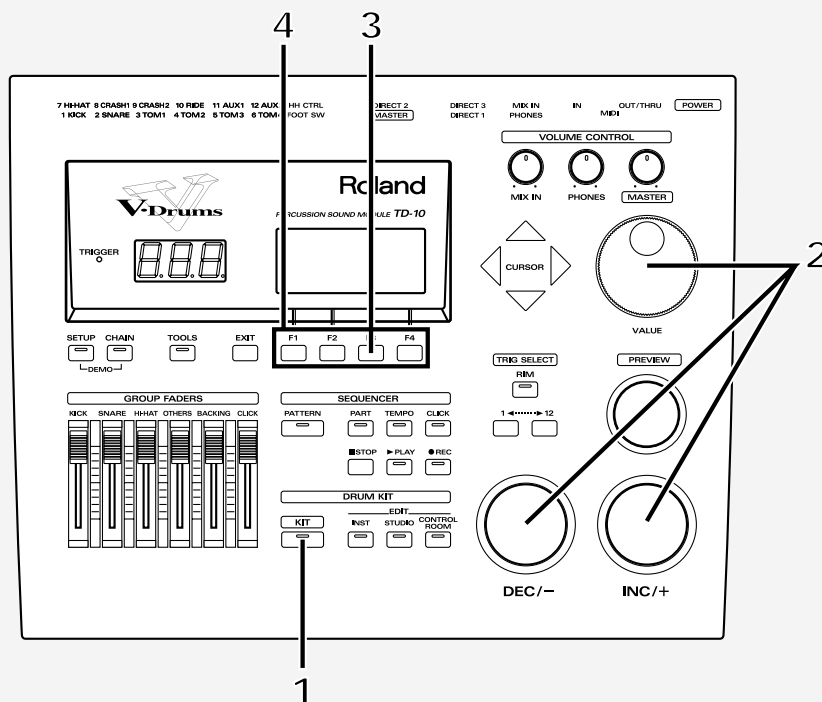

**1** Press [KIT].

The "DRUM KIT" page will appear.

**2** Use [INC/DEC] or the VALUE dial to select kit number 36.



**3** Press [F3 (FX SW)].

The following screen will appear:

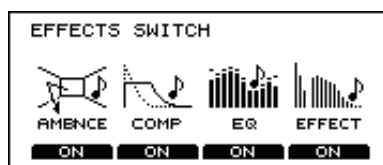

**4** Where there is an indication of "ON" above the [F1]–[F4] buttons, press the button to turn the indication "OFF."

## [INST]: Creating drum sounds

The settings in this section are for the drums themselves, and they are concerned with the fundamental elements that determine the character of the sound. Via easy operations you can proceed through the process of selecting an instrument, deciding its material and shape, and adjust the tuning, etc.



*During the procedures described here, you can use [TRIG SELECT] to select triggers/sounds even if pads are not connected, and use [PREVIEW] to audition the sound.*

### ■ Selecting an instrument

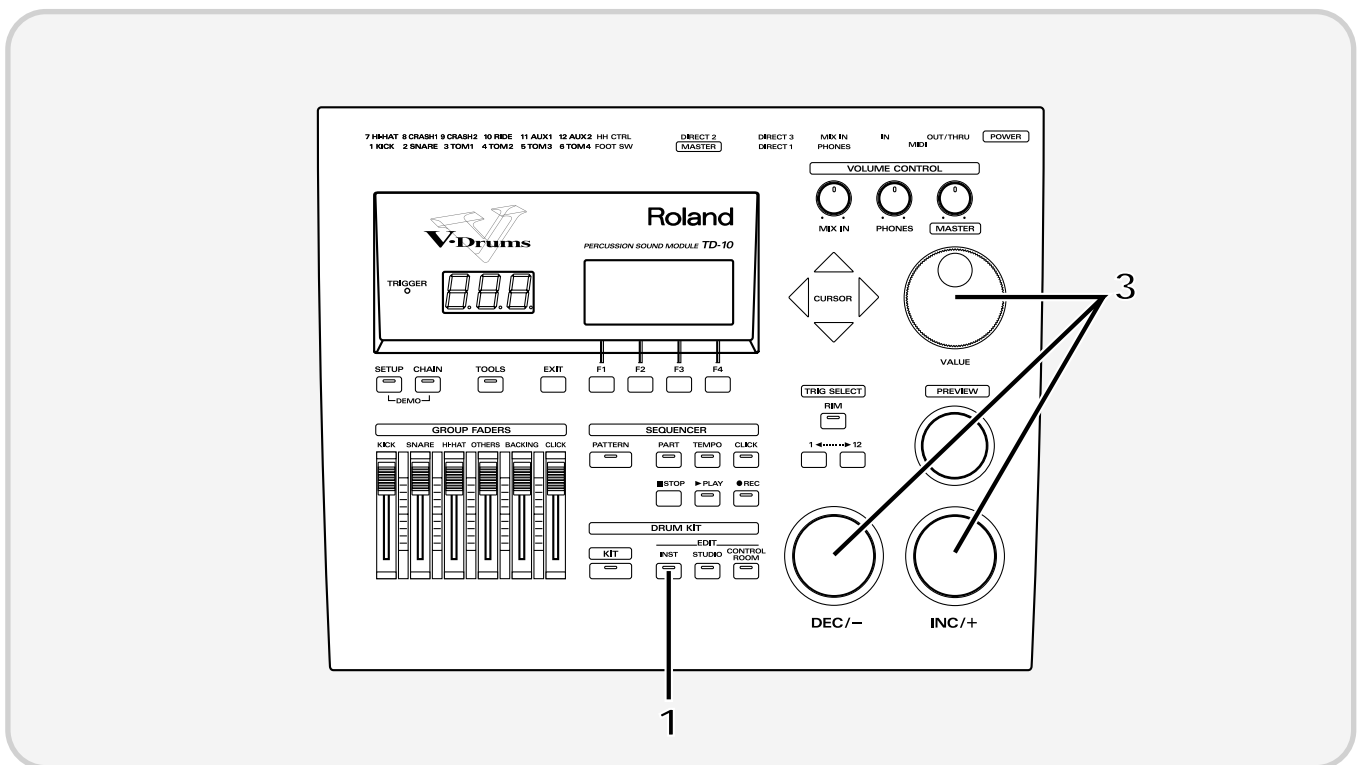

**1** Press [INST].

The following screen will appear:



**2** Strike the pad whose instrument you wish to change.

The instrument select page for the specified pad will appear.

**3** Use [INC/DEC] or the VALUE dial to select a different instrument. Strike the pad as you select different instruments to hear how they sound.

In this example, let's use "106 Maple1 S" as the snare, and edit this to create our sound.

## ■ Modify the material and depth of the body

By changing the material of the instrument body and listening to the difference, you can find the sound that you want. This is an editing method that is only possible on the TD-10. It's just like choosing between a variety of real snare drums.

Here, let's modify the material and depth of the snare drum body.

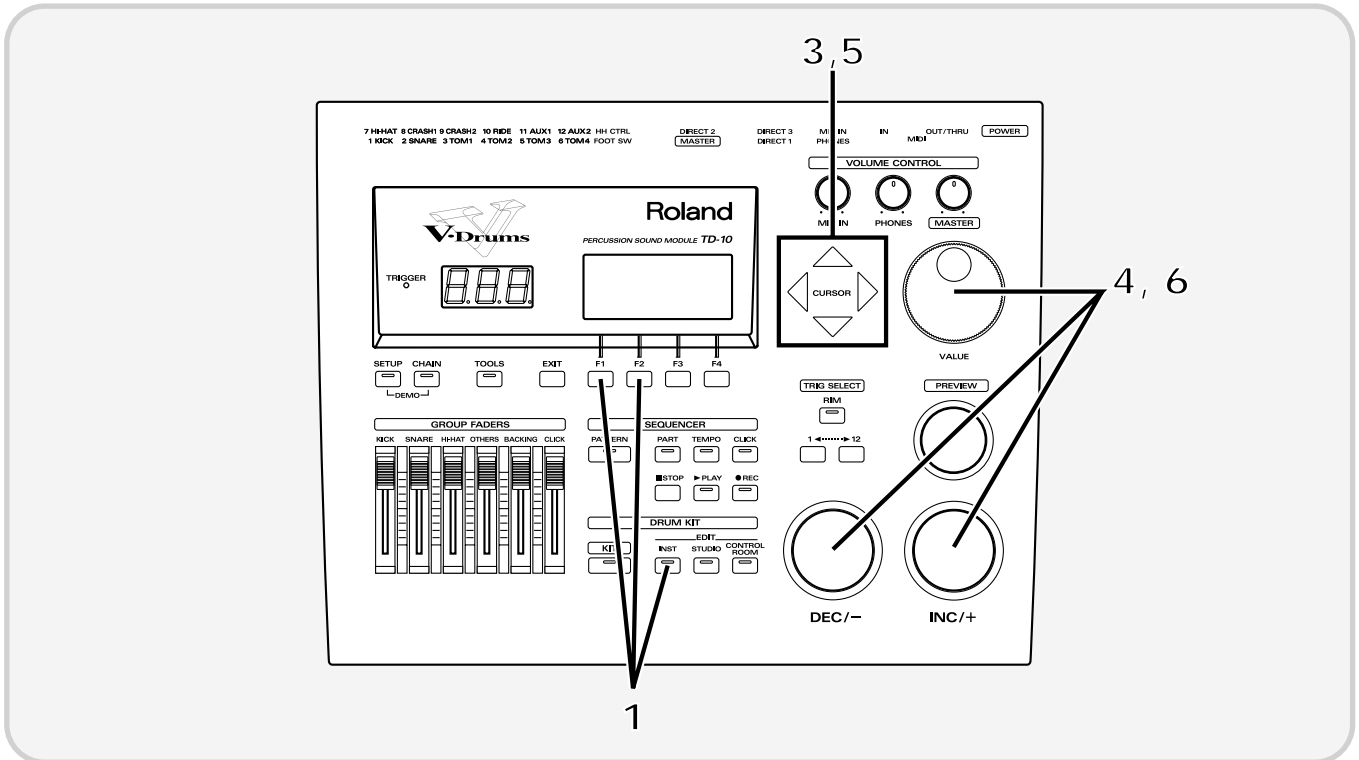

**1** Press [INST], then press [F2 (EDIT)], and then [F1 (SHELL)].

**2** Strike the pad being used for the snare.

The snare setting display page appears. Here, you can choose the material and depth of the body.

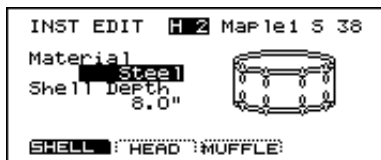

**3** Use [CURSOR] to move the cursor to "Material."



**4** Use [INC/DEC] or the VALUE dial to change the material of the body.

In this example, let's change the setting from "Steel" to "Wood." Of the three types, this will produce the warmest sound.



This completes our selection of the body material. Next we will specify the depth of the body.

**5** Use [CURSOR] to move the cursor to "Shell Depth."

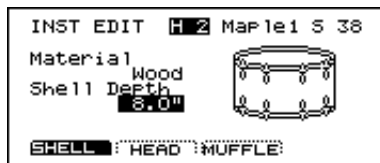

**6** Use [INC/DEC] or the VALUE dial to modify the depth of the body.

Since the current setting is a bit deep, let's change this to "3.5\". Notice how the body resonance decreases.

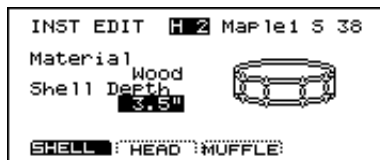

## Change the material and tuning of the head

Here, let's modify the type and tuning of the snare drum head.

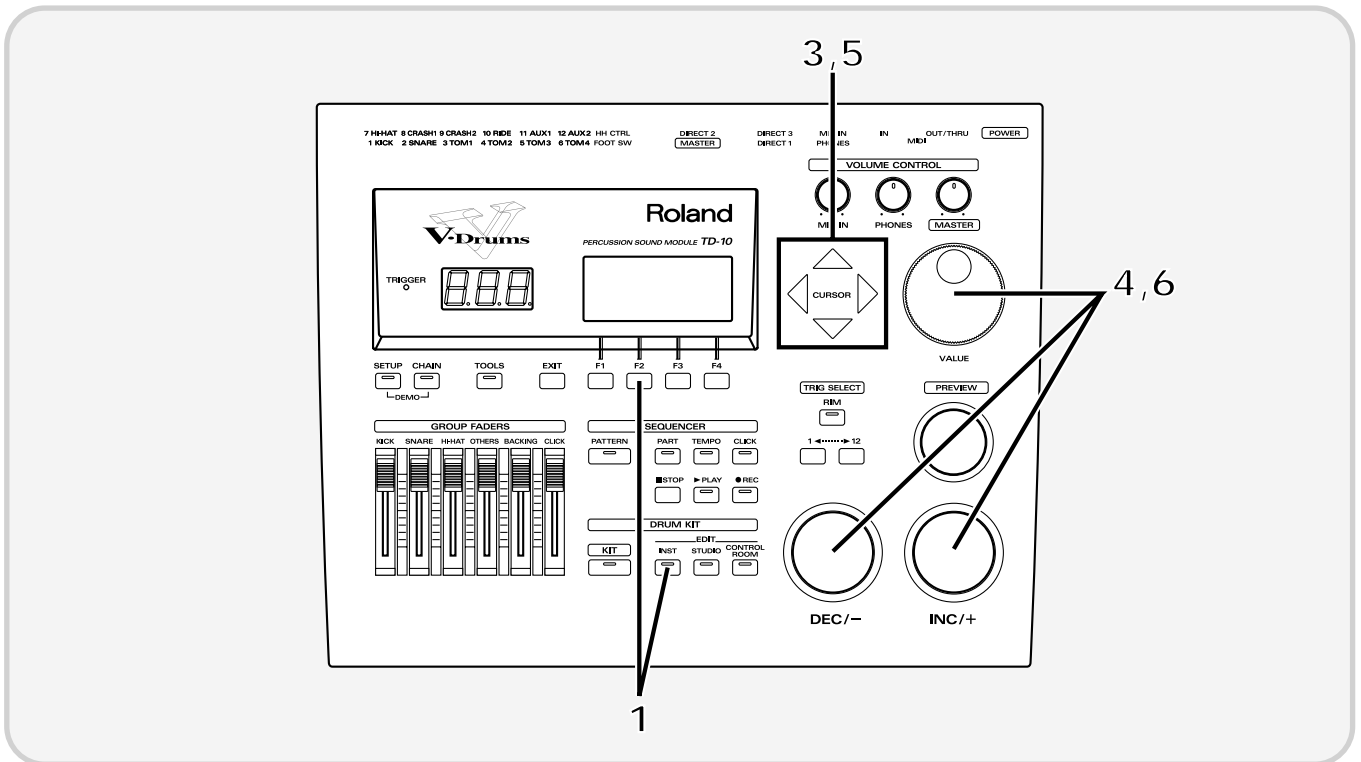

**1** Press [INST], then press [F2 (EDIT)], and then press [F2 (HEAD)].

**2** Strike the pad being used for the snare.

The snare setting page appears. Here, you can type and tuning of the head.

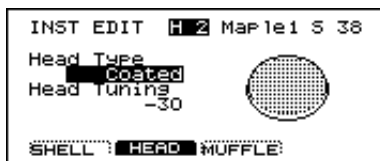

**3** Use [CURSOR] to move the cursor to "Head Type."

**4** Use [INC/DEC] or the VALUE dial to change the type of head.

In this example, let's change the type from "Coated" to "PinStripe®." The sound will become thicker, with fewer overtones.

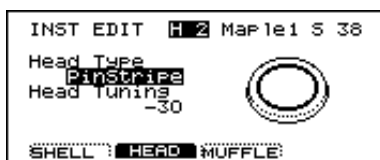

\* PinStripe is a registered trademark of Remo Inc. U.S.A.

This completes the head material choice. Next we'll tune of the head.

- 5 Use [CURSOR] to move the cursor to "Head Tuning."



- 6 Use [INC/DEC] or the VALUE dial to modify the tuning.

Here we will change the setting from "-30" to "0."

## ■ Adjust the muffling (muting) and snare strainer tension

You can add muffling to the snare drum or adjust the tension of the snare strainer to reduce unwanted overtones or resonances, creating a tighter sound. You can even turn the snares off!

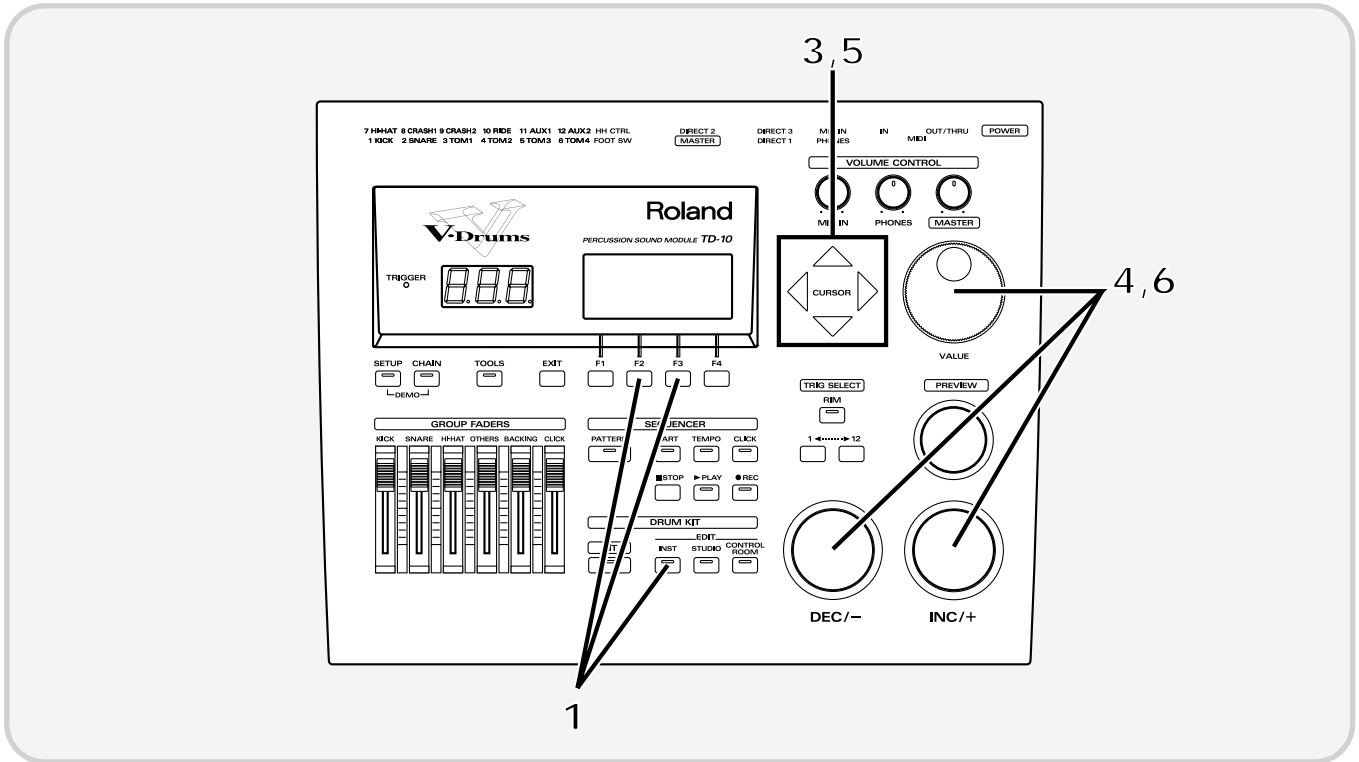

**1** Press [INST], then press [F2 (EDIT)], and then press [F3 (MUFFLE)].

**2** Strike the pad being used for the snare.

The snare setting page appear. Here, you can choose the muffling method and snare strainer tension.

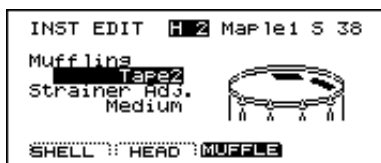

**3** Use [CURSOR] to move the cursor to “Muffling.”

- 4** Use [INC/DEC] or the VALUE dial to modify the setting.

For this example, select “Doughnuts1.” The sound will become somewhat more muted.



This completes the muffling settings. Next we will adjust the tension of the strainer.

- 5** Use [CURSOR] to move the cursor to “Strainer Adj.”

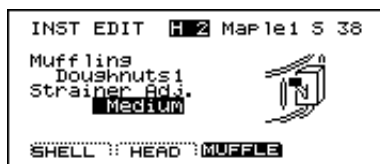

- 6** Use [INC/DEC] or the VALUE dial to modify the setting.

For this example, try “Loose.” Listen to the difference.

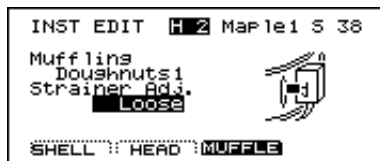

## [STUDIO]: Adjusting the acoustics of the room

One very important element that affects the overall sound of a drum kit is the environment in which the drums are placed. The same drums are capable of producing a very different sound, depending on whether they are played in a conventional studio, or in a glass-walled room. Here you can make such variations in room characteristics with the simple touch of a few buttons.

Here we will try editing Ambience, which is part of the “Studio” settings. First, turn on the Ambience that you turned off before selecting the instruments.

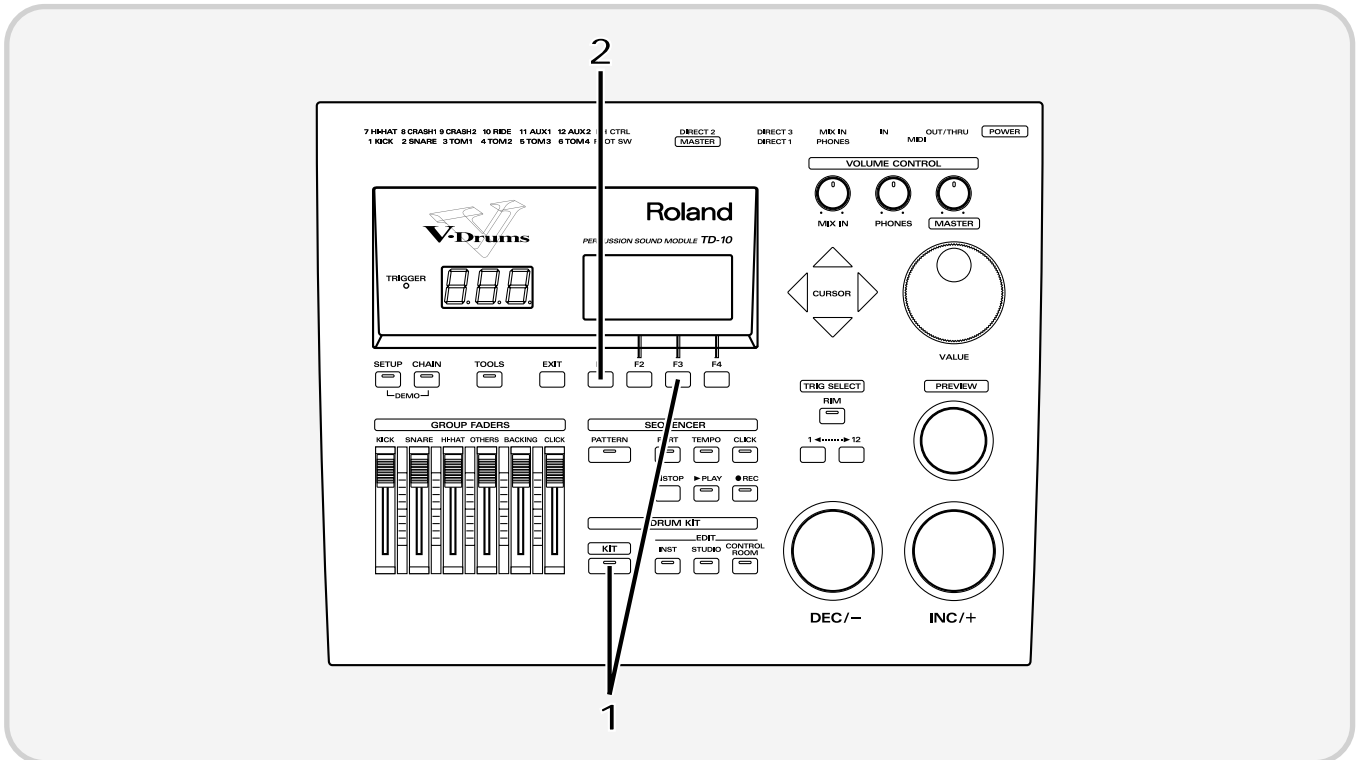

- 1 Press [KIT], and then press [F3 (FX SW)].

The following screen will appear:

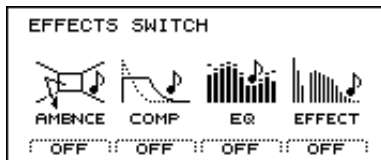

- 2 Press [F1] to turn Ambience “ON.”

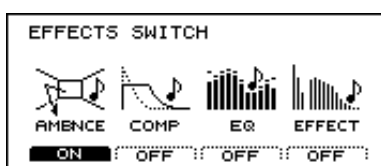

## ■ Decide “where” the drums are played

You can choose locations for your drums from different types of rooms, a cave, a bathroom or even the beach. You make this selection by “seeing” the icon that represents the actual acoustical environment.

The factory preset will be “Gymnasium.” Let’s change this to “Studio.” The resonance will change to that of a more muted room.

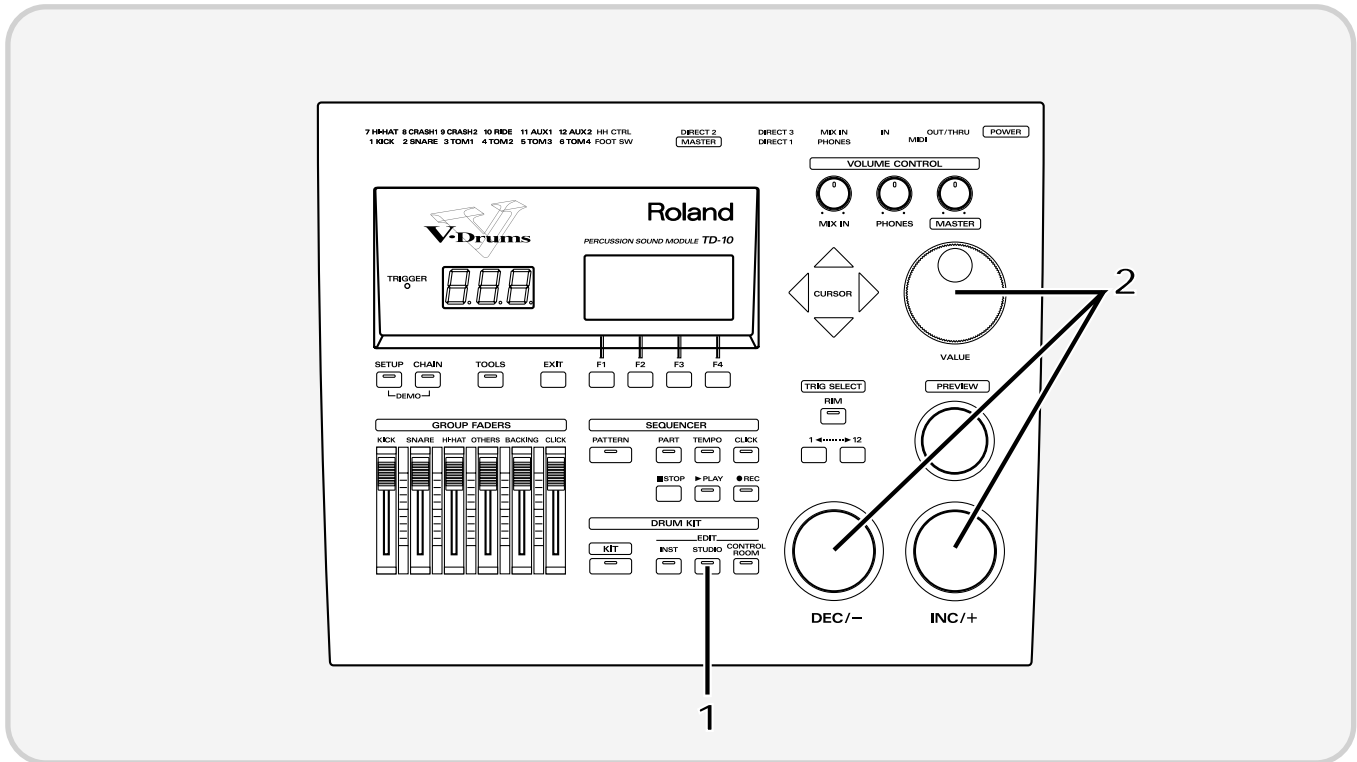

**1** Press [STUDIO].

The currently selected studio settings will be displayed.

**2** Use [INC/DEC] or the VALUE dial to select “Studio.”

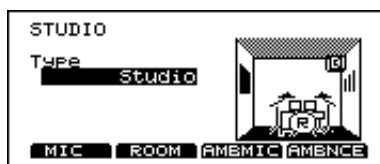

## Change the size of the room

You can modify the “ambience” space by selecting one of five different room sizes.

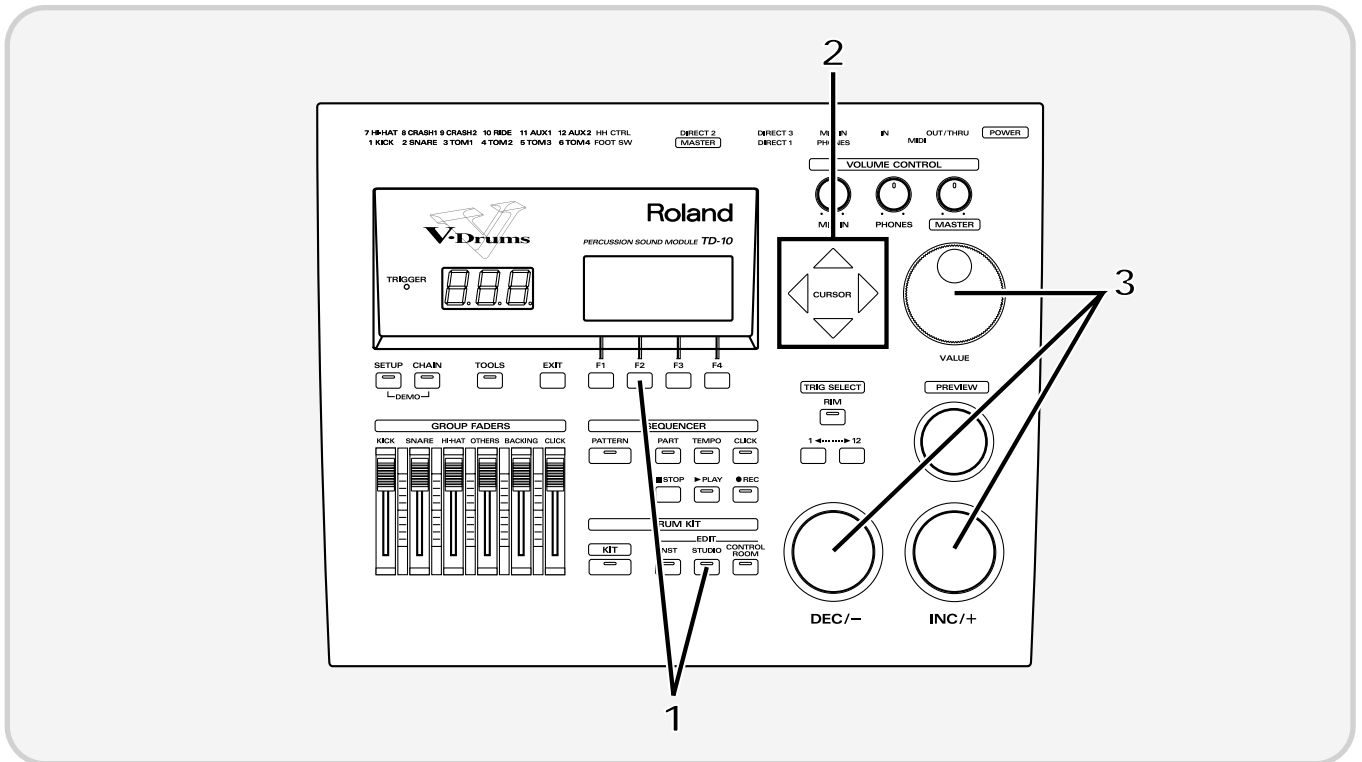

- 1 Press [STUDIO], and then press [F2 (ROOM)].

The following screen will appear:

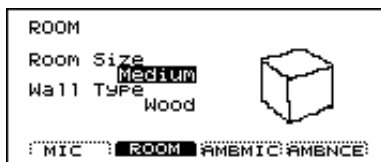

- 2 Use [CURSOR] to move the cursor to “Room Size.”
- 3 Use [INC/DEC] or the VALUE dial to modify the setting.

Small sizes will produce a slight impression of ambient presence, and it will sound as though the drums are being played right in front of your eyes. Larger sizes will produce a more “live” ambience. Adjust this setting as desired.



# [CONTROL ROOM]: Adding finishing touches to the sound

## ■ Using the equalizer to modify the sound

If you want the selected instrument to sound a little different, such as “a bit brighter” or “a bit lighter,” etc., you can use the equalizer to make adjustments. The TD-10 has a 2-band (high and low) equalizer for each instrument, and this can be used to fine tune each sound for the total blend of the kit. This way, you can customize the contrast between individual sounds such as snare and kick for example.

First, turn on the Equalizer that you turned off before selecting the instruments.

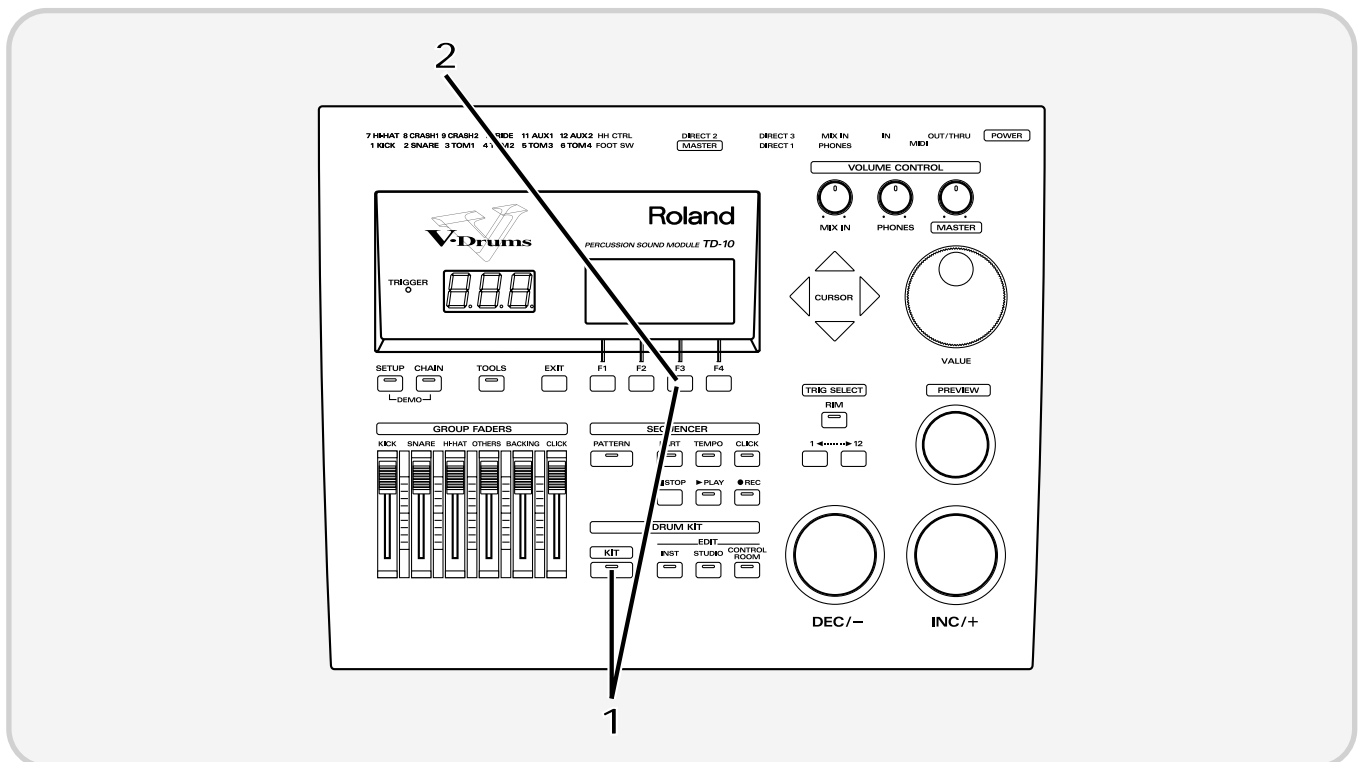

- 1 Press [KIT], and then press [F3 (FX SW)].

The following screen will appear:

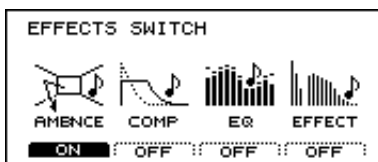

- 2 Press [F3] to turn the equalizer “ON.”

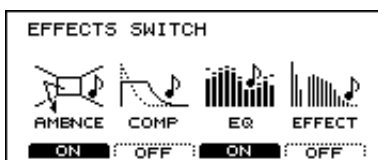

## Modifying a drum kit

In this example, let's assume that we want to make the sound of the snare stand out.

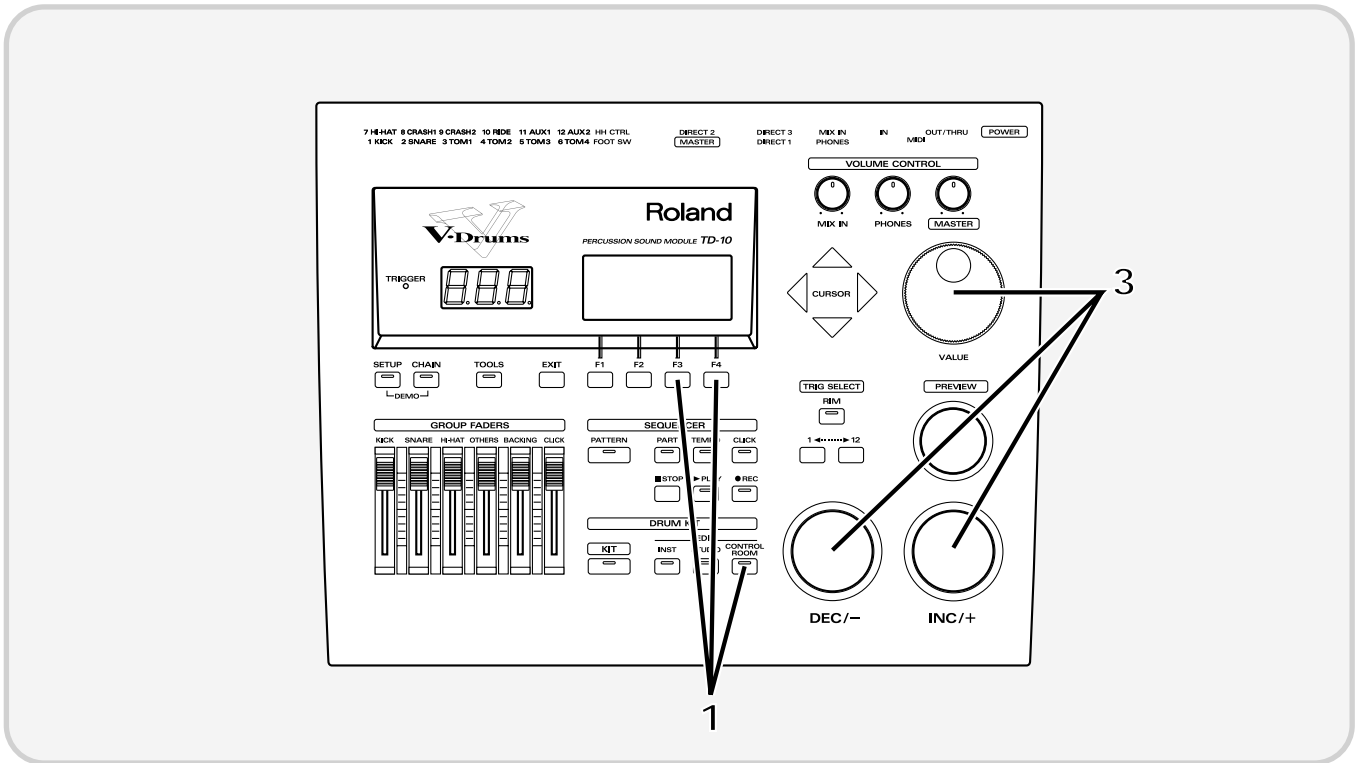

- 1 Press [CONTROL ROOM], press [F3 (EQ)], and then press [F4 (HIGH)]

The following screen will appear:

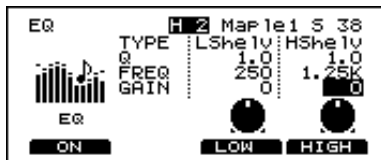

- 2 Strike the pad being used for the snare.

The snare setting screen will appear.

- 3 Use [INC/DEC] or the VALUE dial to modify the value. For this example, adjust the setting to "+5."

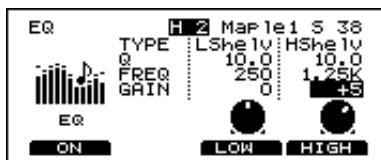

## ■ Adjusting the volume balance of the instruments

Now that we've used the equalizer to boost the high range, the snare sounds brighter. With this change, however, the snare might stand out a bit too much. Let's lower the volume to correct the balance.

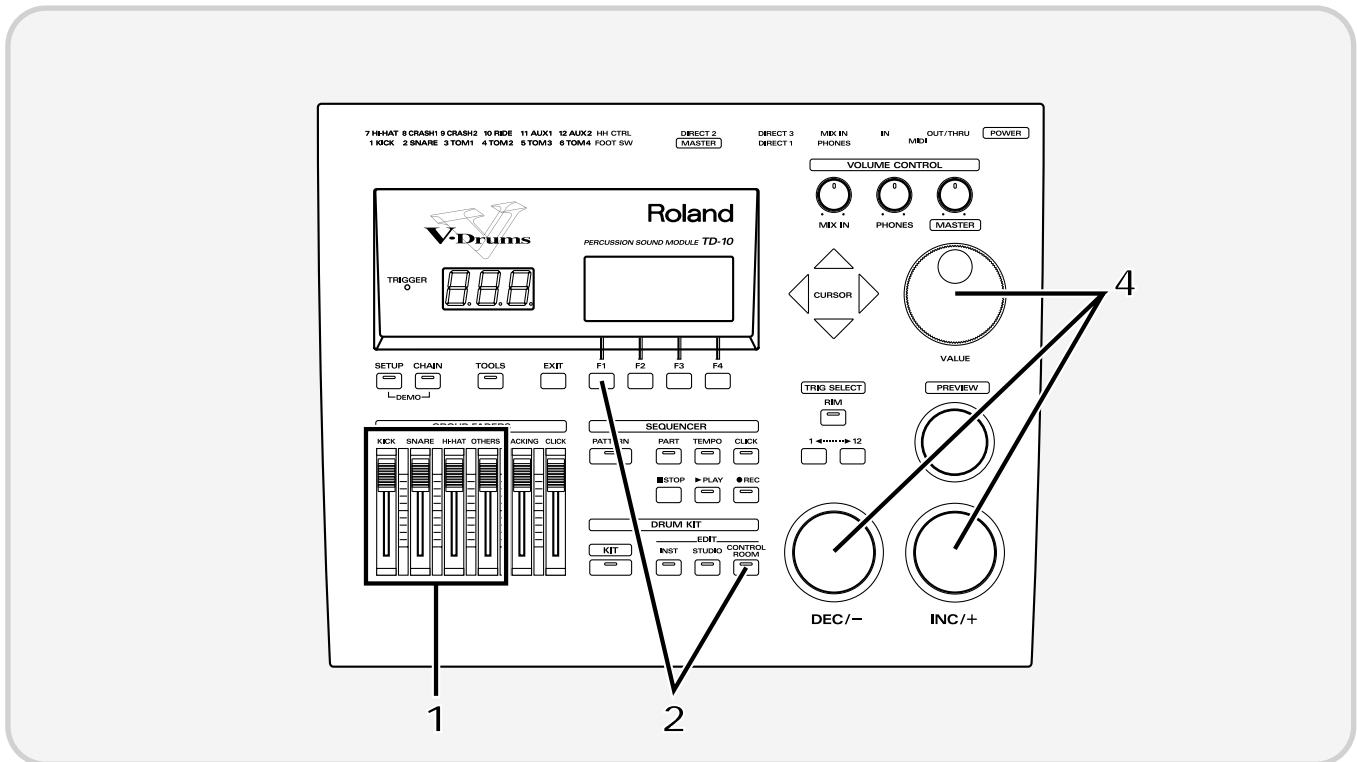

**1** Set each of the [GROUP FADERS] sliders [KICK][SNARE][HI-HAT][OTHERS] to the same volume.

**2** Press [CONTROL ROOM], press [F1 (MIXER)], and then press [F1 (VOLUME)].

The following screen will appear:

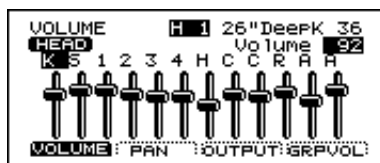

**3** Strike the pad that is being used for the snare.

The snare slider will be selected.

**4** Use [INC/DEC] or the VALUE dial to lower the volume slightly.



*When setting the volume, make sure that the group faders ([GROUP FADERS]) are all at the same level, and use on-screen editing to adjust the volume balance. If you use this method, the same balance will be reproduced each time you select that kit. It is best to use the group faders when you need to make temporary adjustments to the volume. (they will NOT overwrite settings in the mixer page)*

By using the simple procedures that have been introduced above, you can see how the simple and friendly interface allows you to create a wide variety of drum kits, easily accessed by just pushing a button.

# Examples and convenient tips

This section will highlight things that are possible only with electronic musical instruments such as the TD-10.

## Perform with the on-board sequencer

The TD-10 contains a sequencer that can record and play back accompaniment tracks and/or drum performances.

The sequencer contains built-in pattern performances (preset patterns). These patterns can be used as a very helpful practice tool.

### ■ Playing back a preset pattern

Preset patterns 1-36 will playback several measures repeatedly until [STOP] is pressed. These patterns are convenient for drum practicing.

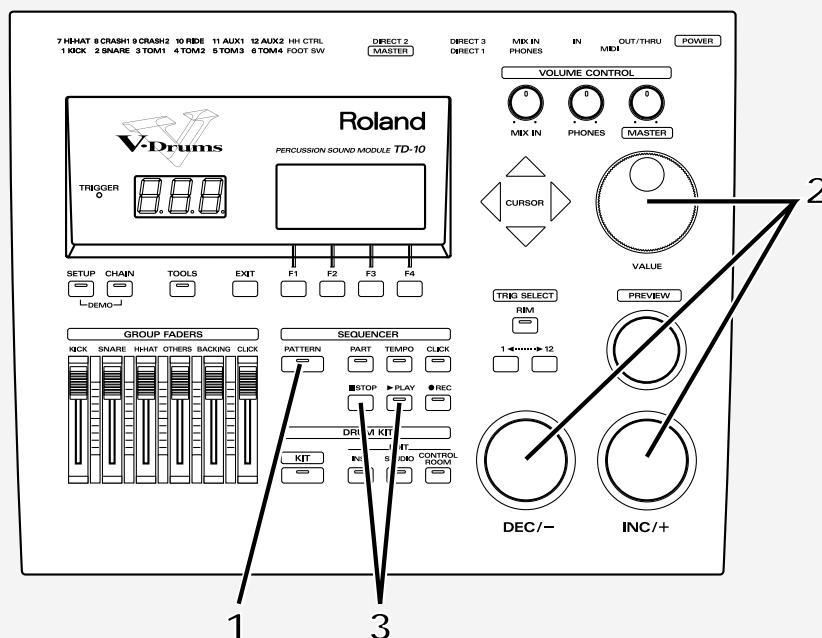

**1** Press [PATTERN].

The number of the currently selected pattern will be displayed.



**2** Use [INC/DEC] or the VALUE dial to select a pattern.

**3** Press [PLAY].

The pattern will begin playing back. Press [STOP] to stop playback, and press it again to return to the beginning of the pattern.

## ■ Play the pads along with a preset pattern

When you have found a preset pattern that you like, you can play along with that pattern. While sounding the click, adjust the volume balance of the drums, backing parts, and the click.

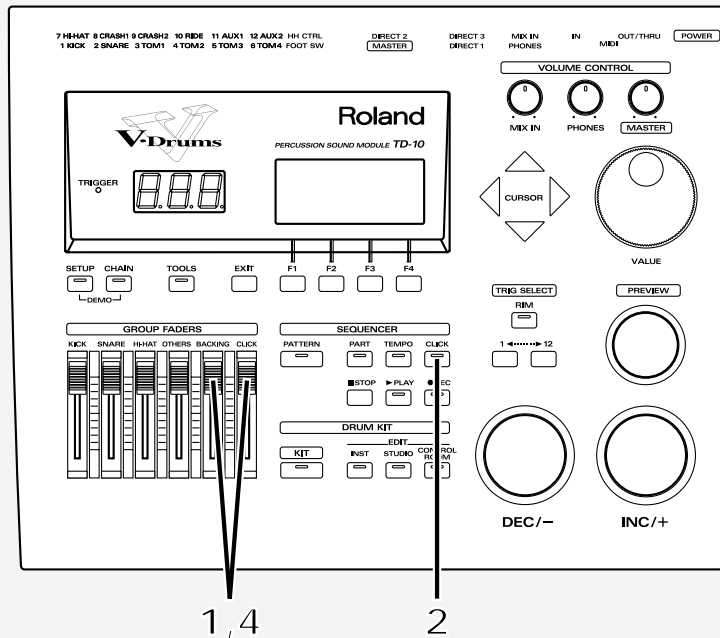

- 1** Adjust the [BACKING] and [CLICK] [GROUP FADERS] lower than the other sliders.
- 2** Press [CLICK].  
The click will begin sounding.
- 3** As described in "Playing back a preset pattern" (p. 68), play back the pattern.
- 4** Gradually raise the [BACKING] and [CLICK] GROUP FADER sliders to adjust the volume balance with the drum kit.

## Drum Kit Chain—Selecting drum kits in the desired order

You can choose the order in which drum kits will be selected.

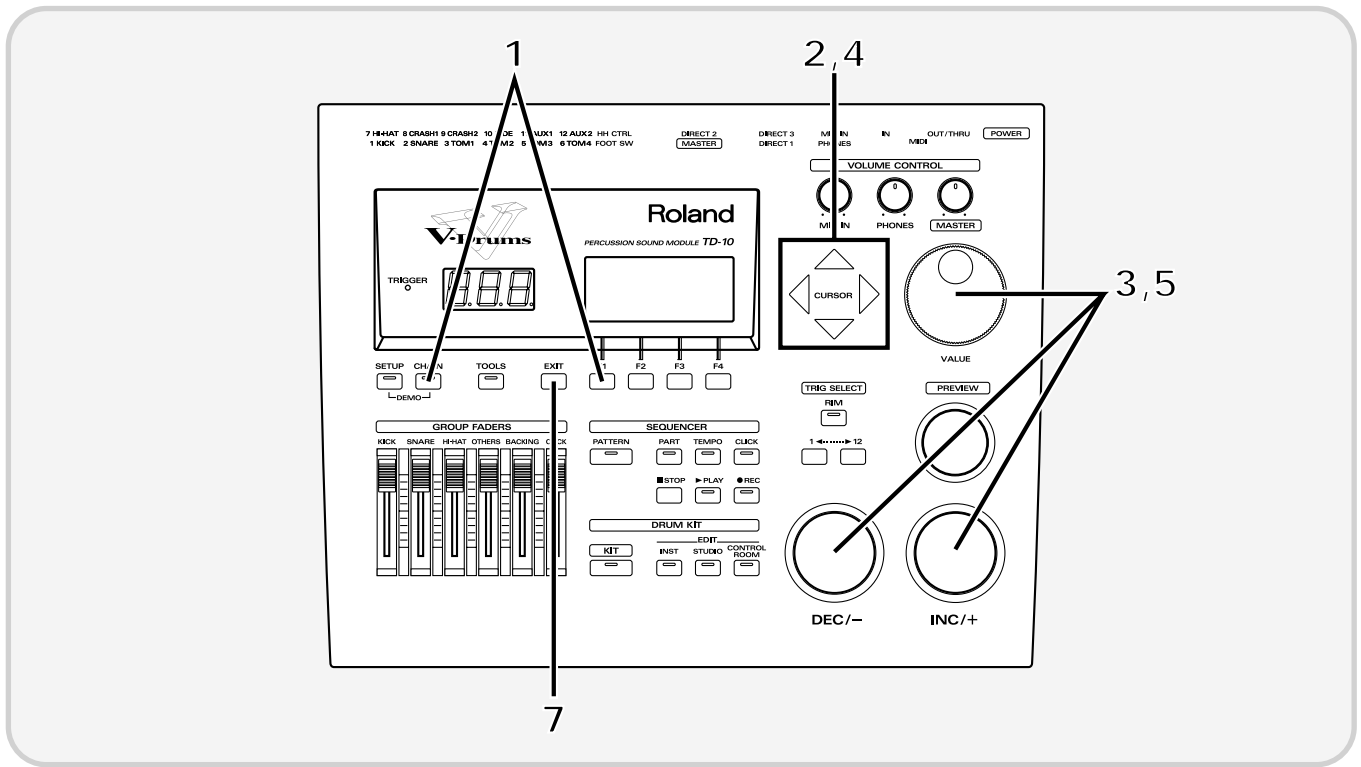

- 1 Press [CHAIN], and then press [F1 (C.EDIT)].

The following screen will appear:



In this screen, you can create a list to specify the order in which the drum kits will be selected.

- 2 Use [CURSOR] to move the cursors to the sequence order in which the drum kits will be selected—the step number "1" located in the right of the screen.



- 3 Use [INC/DEC] or the VALUE dial to select the kit that will be selected first.

- 4 Use [CURSOR] to move the cursor to "2."

**5** Use [INC/DEC] or the VALUE dial to select the kit that will be selected second.

**6** In the same way, make settings for the third and subsequent kits.



To delete an unwanted kit from a step, use [CURSOR] in the “CHAIN” page to select the kit, and then press [F2 (DELETE)].

If you wish to add a kit between steps, press [F1 (INSERT)].

**7** When you finish making the settings, press [EXIT].

You will return to the “DRUM KIT CHAIN” page.



In this page you can use [INC/DEC] to select drum kits in the specified order.



To turn off the Drum Kit Chain function, press [CHAIN] to make the button indicator go dark.

In addition, you can specify pads or foot switches that can be used to select drum kits easily, even while you continue playing. For details refer to “Chapter 9. Operations using pads and foot switches” (p. 119) in the “Advanced Use.”

## Using a foot switch to select kits

When an FS-5U foot switch (optional) is connected to the FOOT SWITCH jack, you can use it to select kits, patterns, or as a play/stop button for patterns (p. 120).

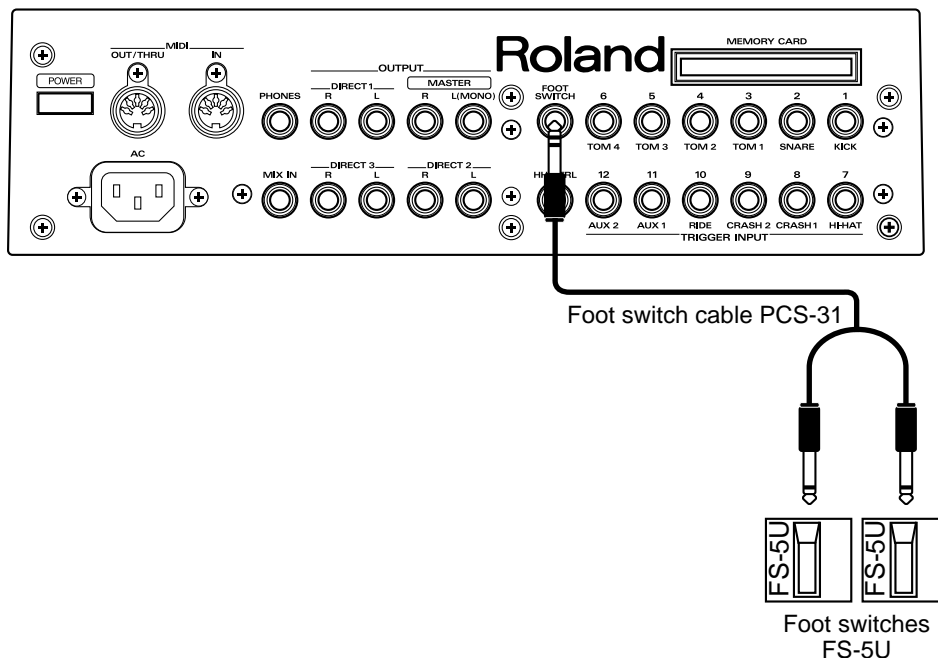

The function that the foot switch will have can be selected by the “Mode” setting in the “FOOT SWITCH” display (p. 120).



## Using a pad to playback patterns

In addition to using pads to play drum sounds, it is also possible to make settings so that striking a pad will start playback of a pattern.(with various possibilities) When this function is used, you can (for example) strike a pad to start playback of a pattern, and then continue playing along with that pattern. This is only possible with electronic drums!



Some of the preset drum kits use this function.  
For details on the settings, refer to p. 119.



## Using headphones to hear the click sound

If you want to listen to a click sound while you play (for example during practice or a live performance), you can make settings so that the click is heard only in the headphones, and is not output from the OUTPUT jacks (MASTER).

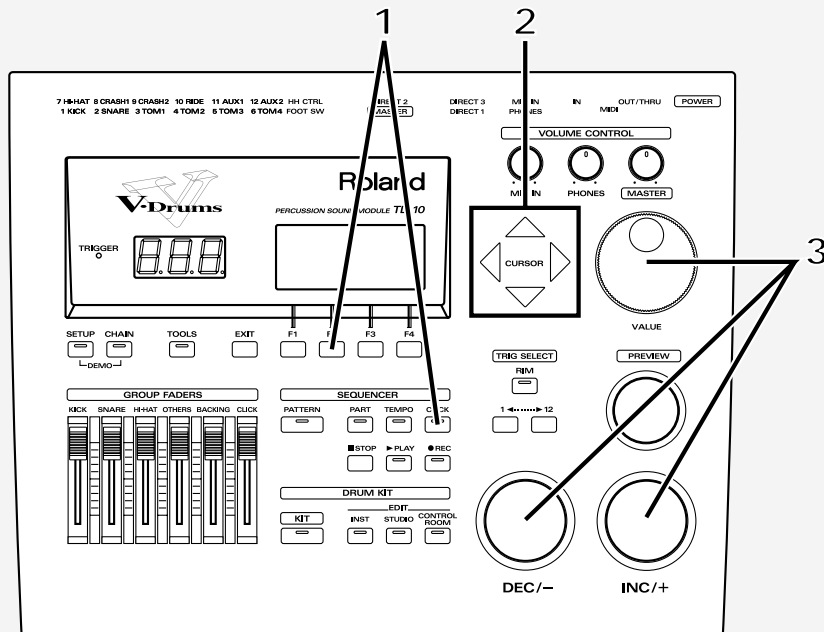

- 1 Press [CLICK], and then press [F2 (INST)].

The following screen will appear:



- 2 Use [CURSOR] to move the cursor to "Output."
- 3 Use [INC/DEC] or the VALUE dial to select "Phones Only."



## Using the TD-10 as a MIDI sound module

The TD-10 can also be used as a sound module for MIDI keyboards or sequencer. When used as a MIDI sound module, the percussion group (p. 126) can be used so that 72 types of instrument can be accessed simultaneously in addition to the sounds that are assigned to the 12 trigger inputs (pads). In addition, three backing parts can be used as sound sources (each with its own individual MIDI channel) as well as the drums. This means that a single TD-10 can be used as a four-part multi part multi-timbral sound source with 56 voices of polyphony! For details refer to “Using the TD-10 as a sound module” (p. 125).

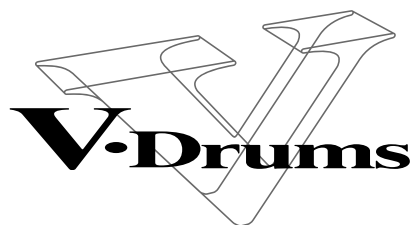

PERCUSSION SOUND MODULE

**TD-10**

# Advanced Use

# Chapter 1. Overview of the TD-10 V-drums

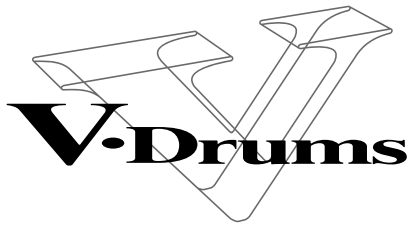

## PERCUSSION SOUND MODULE **TD-10**

The TD-10 is a drum trigger interface and sound module, providing virtual reproduction of an actual drum set, allowing total control over all aspects of drum sound creation.

When electronic drums were first developed, the technology available was not as advanced as it is today, so sounds were not really comparable with acoustic drums. However, many people appreciated electronic drums in their own right for their unique sound quality and character. The early electronic drum systems were fairly expensive, and not that easy to use in a wide musical context. Later, the appearance of “samplers” (instruments using digital recording technology) brought great advances in the quality of acoustic instrument simulations and editing potential of those sounds. Although this technology was developed mostly for synthesizers, it was also applied to rhythm machines and electronic drums though the operating procedures and the sound creating/editing processes were simply carried over from synthesizers.

For many drummers, it became necessary to learn new and unfamiliar technical terms and methods for processing sound, meaning that the “user friendliness” was considerably diminished.

The TD-10 V-drums offers access to the whole family of percussion sounds, including acoustic and electronic drums, and percussion, and provides a control environment that is specially designed for the drummer. This includes choosing your instrument, (out of over 600 sounds!) editing the sounds, and a way to make sure they respond to your style of playing through the advanced and accurate triggering response. You also have control of “where” the drums are played, the acoustics of that environment, the types of microphones used on the drums and their positions and all details of the final mixing process in the “control room.” In other words, the TD-10 alone is a complete drum production concept with a studio, effect units and a mixing console. There are 50 preset drum kits that have been created in this manner, so you can get a feel of the TD-10’s potential once you have completed the basic setup.

## How the V-drums system is organized

The V-drums system can be divided into the following two parts.

- **Controllers such as pads and pedals on which you perform**
- **The sound module that produces sounds in response to your performance on the pads or pedals**

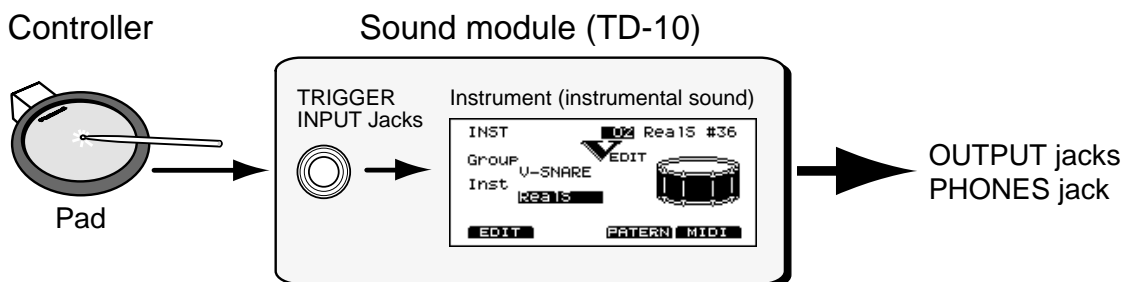

In this system, the TD-10 is the sound module.

When the TD-10 receives signals (trigger signals) received after pads are hit (or via MIDI) it plays the corresponding instrumental sounds.

\* The term “trigger signal” will appear frequently in this manual, so become familiar with the term as it will help you understand the explanations that follow (p. 172).

## How to select pads

When making settings, you can specify the pad in one of the following two ways.

### ■ Using pads to select the pad/sound for editing

Strike the head (the head and rim simultaneously) of the pad. The setting display for the pad you struck will appear. Listen to the sound as you strike the head (the head and rim simultaneously), and use [INC/DEC] or the VALUE dial to modify the setting.

### ■ Using the TD-10 to select the pad/sound for editing

Use the “1” button or “12” button located below [TRIG SELECT] to select a trigger signal (corresponds to the 12 trigger inputs). To edit the rim settings, press [RIM] to make the indicator light. When using [PREVIEW] to audition a sound, use [INC/DEC] or the VALUE dial to modify the setting.

\* When separate settings can be made for the head and the rim, a display such as the following will appear. For details refer to p. 136.

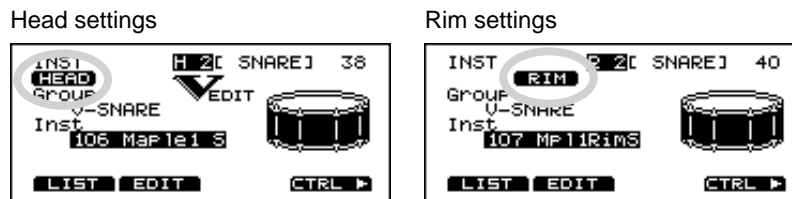

In this owner's manual, a symbol such as the following will mark functions that can be set independently for head and rim.

**HEAD RIM**

# Chapter 2. Settings for the entire drum kit

## Selecting a kit

Press [KIT], and the basic display page will appear. In this page, you can use [INC/DEC], the VALUE dial or a foot switch (optional) to select drum kits (p. 120).



Area 1 in the above figure indicates whether the selected kit contains settings for performance with sticks or for brushes. To change this setting see “Making settings for brush performance” (p. 79). Area 2 indicates effect on/off settings for the entire kit. Please refer to “Effect switches for the entire kit” (p. 79). Area 3 will appear if a card is inserted into the TD-10. If the card’s protect switch is on, a lock symbol will appear.

\* To prevent data from being accidentally modified while you play, it is a good idea to select this display page once you have finished making settings.

## Selecting kits from the list display

Here you can select drum kits by accessing the full list of available kits.



### Procedure

1. Press [KIT]-[F1 (LIST)].  
The “DRUM KIT LIST” page will appear.
2. Use the VALUE dial, [INC/DEC], or [CURSOR] to select a kit.

### Function buttons

- [F1 (PAGE <)]: The previous page of the list will appear.  
[F2 (PAGE >)]: The next page of the list will appear.

## Naming a kit

Each kit can be given a name of up to 8 characters.



### Procedure

1. Press [KIT]-[F2 (FUNC)]-[F4 (NAME)].  
The “DRUM KIT NAME” page will appear.
2. Use the left/right [CURSOR] buttons to select the character that you wish to change.  
The character at the blinking location is the one that can be changed.
3. Use the VALUE dial, [INC/DEC], or [CURSOR] (up/down) to change the character.  
Characters can be selected in the order of the small characters displayed in the bottom of the screen.

### Function buttons

- In this page the [F1]-[F4] buttons can be used to perform the following convenient functions for entering characters.
- [F1 (INSERT)]: All characters to the right of the cursor will be moved to the right.
- [F2 (DELETE)]: The character at the cursor location will be deleted, and all characters to the right of the cursor will be moved to the left.
- [F3 (SPACE)]: A blank space will be inserted at the cursor location.
- [F4 (CHAR)]: Cycle between uppercase/lowercase/symbols.

## Making settings for brush performance

For each kit you can specify whether sticks or brushes will be used. When the trigger setting is set to “brush,” pad sensitivity will be higher. Each kit has settings for sticks and for brushes, and the brush settings can be selected as follows.

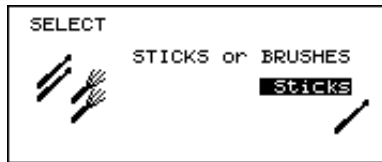

### Procedure

1. Press [KIT]-[F2 (FUNC)]-[F3 (SELECT)].  
The “SELECT” page will appear.

2. Use [INC/DEC] or the VALUE dial to select “Brushes.”  
The settings for brush performance will be selected.

\* Preset drum kits for brushes are already set for brush performance. The setting discussed here is necessary when you wish to modify a kit that was created for stick performance in order to play with brushes. If you wish to create a new brush kit, it's simpler to copy an existing one and then edit it as you wish.

\* The setting you make here can also be viewed in the drum kit name page (“DRUM KIT”).

\* When performing brush swish/sweeping, the following conditions must also be met in addition to the above setting.

Trigger jack 2 must be used. (for the snare drum)

PD-120 or PD-100 pads must be used.

Make sure that you are using instrument number 113 “Brush1 S,” number 114 “Brush2 S” or 115 “BrushTmbS.”

## Effect switches for the entire kit

Ambience, compressors, equalizers, and digital effects can be turned on/off for the entire kit. This gives you a great way to “compare” your sounds with or without those functions.

### Procedure

1. Press [KIT]-[F3 (FX SW)].

The “EFFECTS SWITCH” page will appear.

2. Each time you press a function button [F1]-[F4], the corresponding effect will be switched on/off.

### Function buttons

[F1 (AMBNCE)]: Ambience on/off switch

[F2 (COMP)]: Compressor on/off switch

[F3 (EQ)]: Equalizers on/off switch

[F4 (EFFECT)]: Effect on/off switch

\* The settings made here can also be seen in the drum kit name page (“DRUM KIT”).

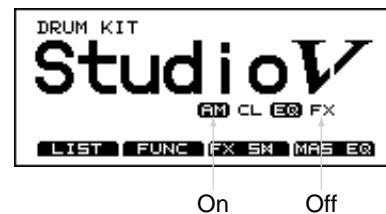

# Chapter 3. Instrument settings

Here you can edit the instruments.(i.e. snare drum kick etc.)  
The TD-10 provides separate parameters for editing acoustic or electronic drum sounds.

## Selecting an instrument

### HEAD RIM

On the TD-10, each sound, is referred to as an "instrument" (INST). You'll begin the sound-creating procedure by selecting the desired instruments.



### Procedure

(Example) Changing the snare

1. Press [INST].

The "INST" page will appear.

2. Strike the snare pad.

The name of the instrument being triggered by the snare pad will appear at "Inst." The "type" of the currently selected instrument will appear at "Group."

3. Use [INC/DEC] or the VALUE dial to select an instrument.

\* *There are instruments that cannot be selected There are some instrument combinations that cannot be selected within the same kit, or with certain trigger inputs. The V-EDIT process is not available for all instruments (p. 136).*

## Selecting instruments from the list display

Here you can choose the sound from the list of all instruments.



### Procedure

1. Press [INST]-[F1 (LIST)].

The "INST LIST" page will appear.

2. Strike the pad whose instrument you wish to change.

The setting page for the pad you struck will appear. The cursor will be at the name of the currently selected instrument.

3. Use the VALUE dial, [INC/DEC] or [CURSOR] to select an instrument.

4. After you have selected an instrument, press [EXIT].

You will return to the "INST" page.

### Function buttons

[F1 (PAGE <)]: The previous page of the list will appear.

[F2 (PAGE >)]: The next page of the list will appear.

You can also use the Function Key to scroll through the instrument list at a higher speed.

To advance quickly Hold down [F2 (PAGE >)] and press [F1 (PAGE <)]

To move in reverse quickly Hold down [F1 (PAGE <)] and press [F2 (PAGE >)]

\* *Instruments which cannot be selected for specific triggers are indicated by a horizontal line as in the following diagram.*

Instruments which cannot be selected





## Editing an acoustic drum kit (V-EDIT)

### ● V-EDIT and EDIT

Editing procedure for an acoustic snare, kick and tom drums will differ depending on the type of instrument and the TRIGGER INPUT jack that you are using.

1. V-EDIT lets you use all the editing capability of the TD-10
2. EDIT lets you edit only the two parameters Pitch and Decay

### ● VERY IMPORTANT!! When V-EDIT can be used

“V-EDIT” will appear ONLY when using trigger inputs 1–6 and an instrument from instrument groups “V-KICK”, “V-SNARE”, or “V-TOM.” (A “V-EDIT” symbol will appear in the setting page.) When an instrument from another instrument group is assigned, only Pitch and Decay can be edited. So if you assign a “V” type sound to an input other than 1-6, you cannot use the V-Edit parameters.

For details on assigning instruments, refer to p. 136.

The parameters available in V-EDIT will differ depending on the trigger input and instrument selected. The following parameters can be edited.

Trigger	Shell Material	Shell Depth	Head Type	Head Tuning	Muffling	Strainer Adj.
1 (KICK)	-	0	0	0	0	-
2 (SNARE)	0	0	0	0	0	0
3-6 (TOM)	-	0	0	0	0	-

0: Can be set      -: Cannot be set

## ■ Selecting the shell material

Changing the material of the snare drum shell produces a different tone. You can select one of three materials: wood, steel and brass.



### Instruments that can be edited

Snare only

#### Procedure

1. Press [INST]-[F2 (EDIT)]-[F1 (SHELL)].  
The “INST EDIT” page will appear.
2. Strike the snare pad.  
The snare setting page will appear.
3. Use [CURSOR] to move the cursor to “Material.”
4. Use [INC/DEC] or the VALUE dial to make the setting.

#### Parameters

Material: Wood, Steel, Brass

Wood: Wood body. This produces a natural and mellow sound.

Steel: Steel body. This produces a sound with metallic resonance.

Brass: Brass body. This produces the unique resonance of brass.

## ■ Changing the shell depth

Changing the depth of the drum shell will change the tone. With the snare drum, the depth can be changed over 39 steps, from 1 to 20 inches! Making the shell deeper will increase the richness of the low range, and make the sound more “fat”.

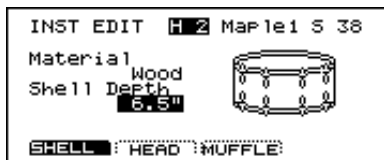

### Instruments that can be edited

Kick, Snare, Tom

#### Procedure

1. Press [INST]-[F2 (EDIT)]-[F1 (SHELL)].  
The “INST EDIT” page will appear.
2. Strike the pad that you wish to edit.  
The setting page for the pad you struck will appear.
3. Use [CURSOR] to move the cursor to “Shell Depth.”
4. Use [INC/DEC] or the VALUE dial to make the setting.

#### Parameters

Shell Depth: Normal, Deep (Kick)  
1–20 inch (39 steps) (Snare)  
Normal, Deep (Tom)

## ■ Selecting the head material

Changing the “type” of drum head will affect aspects of attack and tone. You can choose from three type of heads: Clear, Coated, and PinStripe®

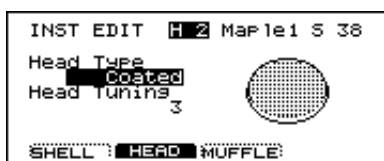

### Instruments that can be edited

Kick, Snare, Tom

#### Procedure

1. Press [INST]-[F2 (EDIT)]-[HEAD(F2)].  
The “INST EDIT” page will appear.
2. Strike the pad that you wish to edit.  
The setting page for the pad you struck will appear.
3. Use [CURSOR] to move the cursor to “Head Type.”
4. Use [INC/DEC] or the VALUE dial to make the setting.

### Parameters

Head Type: Clear, Coated, PinStripe®

Clear: A single transparent head.

Coated: The most commonly used type of head.

PinStripe®: Characterized by a rich medium and low range “color.”

\* PinStripe is a registered trademark of Remo Inc. U.S.A.

## ■ Tuning the head

Here you can tune the drum head very accurately.



### Instruments that can be edited

Kick, Snare, Tom

#### Procedure

1. Press [INST]-[F2 (EDIT)]-[F2 (HEAD)].  
The “INST EDIT” page will appear.
2. Strike the pad that you wish to edit.  
The setting page for the pad you struck will appear.
3. Use [CURSOR] to move the cursor to “Head Tuning.”
4. Use [INC/DEC] or the VALUE dial to make the setting.

#### Parameters

Head Tuning: -480—+480 (-4—+4 octaves)

\* For some instruments, raising or lowering the value beyond a certain point may not produce further change.

## ■ Muffling settings (muting)

You can literally apply tape or “rings” to dampen the overtones.

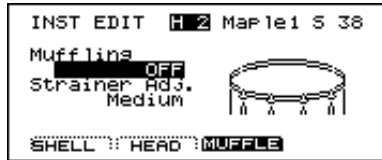

### Instruments that can be edited

Snare, Kick, Tom

### Procedure

1. Press [INST]-[F2 (EDIT)]-[F3 (MUFFLE)].  
The “INST EDIT” page will appear.
2. Strike the pad that you wish to edit.  
The setting page for the pad you struck will appear.
3. Use [CURSOR] to move the cursor to “Muffling.”
4. Use [INC/DEC] or the VALUE dial to make the setting.

### Parameters

Muffling: OFF, Tape 1, Tape 2, Blanket, Weight (Kick)  
OFF, Tape 1, Tape 2, Doughnuts 1, Doughnuts 2 (Snare)  
OFF, Tape 1, Tape 2, Felt 1, Felt 2 (Tom)

OFF: No muffling.  
Tape 1: one piece of tape.  
Tape 2: two pieces of tape.  
Blanket: Muffled by placing a blanket inside the kick drum.  
Weight: Blanket with a weight on top.  
Doughnuts 1: common “ring” type mute.  
Doughnuts 2: common “ring” type mute with stronger muffling of overtones.  
Felt 1: Conventional felt type mute.  
Felt 2: Conventional felt type mute with more pressure on the head.

## ■ Adjusting the Snare strainer tension

The amount of contact between the bottom head and the snares themselves can be adjusted to change the tone just like with a real acoustic drum. You have a choice between one of three tensions: Loose, Medium or Tight or you can turn the snares OFF.

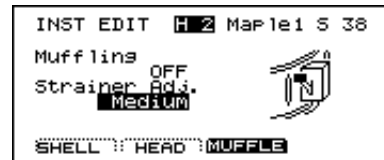

### Instruments that can be edited

Snare only

### Procedure

1. Press [INST]-[F2 (EDIT)]-[F3 (MUFFLE)].  
The “INST EDIT” page will appear.
2. Strike the snare pad.  
The snare setting page will appear.
3. Use [CURSOR] to move the cursor to “Strainer Adj.”
4. Use [INC/DEC] or the VALUE dial to make the setting.

### Parameters

Strainer Adj.: OFF, Loose, Medium, Tight

OFF: The sound with no snares.

Loose, Medium, Tight:

The strainer tension becomes progressively stronger.

## Editing an electronic drum kit (V-EDIT)

Electronic drum sounds consist of “tone” and “noise.” These instruments can be assigned only to specific trigger inputs. For details on instrument assignments, refer to p. 136.

\* *With electronic drums, selecting an instrument for the head will assign the same instrument to the rim. It is not possible to change the rim to a different instrument.*

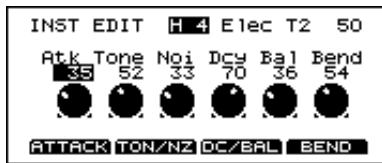

**IMPORTANT:** Instruments that can be used for specific trigger inputs Instruments from the “ELEC” instrument group can be used ONLY with trigger inputs 1-6. Example: An Electronic Kick can only be used with the trigger input (1) dedicated for the Kick.

### Procedure

1. Press [INST].  
The “INST” page will appear.
2. Strike a pad that is connected to a TRIGGER INPUT jack (1-6).  
The setting page for the pad you struck will appear.
3. Use [INC/DEC] or the VALUE dial to select an instrument from the “ELEC” instrument group.
4. Press [F2 (EDIT)].  
The setting page for the selected instrument will appear.
5. Use [CURSOR] to move the cursor to the parameter that you wish to set.  
\* *You can also use the [F1]–[F4] buttons to select parameters.*  
[F1]: Atk  
[F2]: Each time the button is pressed, Tone or Noi will be selected.  
[F3]: Each time the button is pressed, Dcy or Bal will be selected.  
[F4]: Bend
6. Use [INC/DEC] or the VALUE dial to make the setting.

### Parameters

Instruments from the “ELECTRONIC” instrument group provide the following parameters.

Atk (Attack Level ): 0–127

Adjusts the volume of the attack (the beginning of the sound).

Tone (Tone Pitch ): 0–127

Adjusts the pitch of the “tone” component.

Noi (Noise Pitch): 0–127

Adjusts the pitch of the “noise” component.

Dcy (Decay): 0–127

Adjusts the decay time of the sound.

Bal (Noise Tone Balance): 0–127

Adjusts the volume balance between the “noise” and “tone” components.

Bend (Pitch Bend): 0–127

Adjusts the extent of the pitch change that occurs during the sound. This setting adjusts the pitch at which the sound begins.

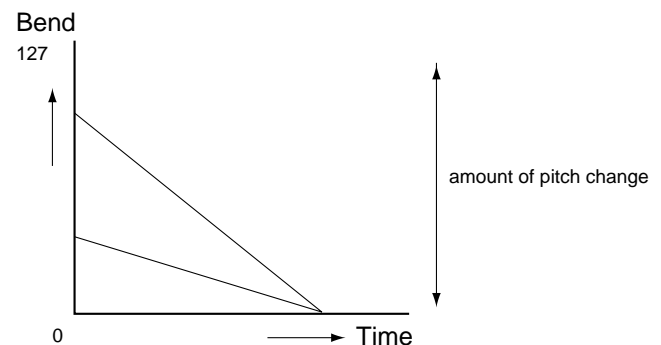

## Editing a TR-808/909 (V-EDIT)

This simulates a Roland “TR-808” or “TR-909” Rhythm Composer. Only instruments specified for each trigger input can be selected. For details on instrument assignments, refer to p. 136.

\* For instruments in the TR-808/909 groups, selecting an instrument for the head will assign the same instrument for the rim. It's not possible to change the rim to a different instrument.



### Instruments and parameters usable for each trigger input

Instruments in the “TR-808” or “TR-909” instrument group can be used only for trigger inputs 1–6. Specific trigger jacks are used for specific instruments, such as “a kick instrument for the kick jack.” The following parameters can be edited.

\* The [F2]–[F4] buttons can be used to select parameters.

#### TR-808

Trigger	[F2]	[F3]	[F4]
1 (KICK)	Tune	Decay	Tone
2 (SNARE)	Tune	Snappy	Tone
3–6 (TOM1–4)	Tune	Decay	-

#### TR-909

Trigger	[F2]	[F3]	[F4]
1 (KICK)	Tune	Decay	Attack
2 (SNARE)	Tune	Snappy	Tone
3–6 (TOM1–4)	Tune	Decay	-

### Procedure

1. Press [INST].

The “INST” page will appear.

2. Strike a pad connected to a TRIGGER INPUT jack 1–6.

The setting page for the pad you struck will appear.

3. Use [INC/DEC] or the VALUE dial to select the TR-808/909 instrument.

4. Press [F2 (EDIT)].

The setting page for the selected instrument will appear.

5. Use [CURSOR] to move the cursor to the parameter that you wish to set.

6. Use [INC/DEC] or the VALUE dial to make the setting.

### Parameters

Attack (Attack Level): 0–127

Adjusts the volume of the attack (the beginning of the sound).

Tone (Tone Pitch): 0–127

On the TR-808/909, this parameter simulated the brightness of the drum.

Snappy: 0–127

This is the TR-808/909 parameter that simulates snare strainer tension.

Decay (Decay Time): 0–127

Adjusts the decay time of the sound.

Tune: 0–127

On the TR-808/909, this parameter simulated the tension of the drum head. The pitch and thickness of the sound will change.

## Editing hi-hat, cymbals and percussion

---

Only pitch and decay can be edited for instruments that are assigned to trigger inputs 7–12. Even for trigger inputs 1–6, only pitch and decay can be edited if the assigned instrument is not V-EDIT capable.

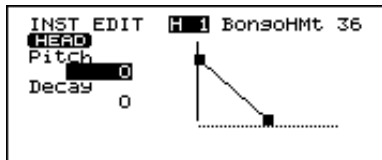

### Procedure

1. Press [INST].  
The "INST" page will appear.
2. Strike a pad connected to a TRIGGER INPUT jack 7–12.  
The setting page for the pad you struck will appear.
3. Use [INC/DEC] or the VALUE dial to select a hi-hat, cymbal or percussion instrument.
4. Press [F2 (EDIT)].  
The setting page for the selected instrument will appear.
5. Use [CURSOR] to move the cursor to the parameter that you wish to set.
6. Use [INC/DEC] or the VALUE dial to make the setting.

### Parameters

Pich: -480+480

Adjusts the pitch of the sound.

Decay: -31+31

Adjusts the decay time of the sound.

\* For some instruments, raising/lowering the value beyond a certain level will not produce any further change in Decay.

# Chapter 4. Studio settings

Here is where you can virtually change the acoustics of the room in which you are playing the drums. The parameters available here let you select actual room sizes and wall materials to easily get your desired sound. You can also change the positions of the “room” microphones.

An easy way to understand this is to change the type of studio as explained below in “Selecting the studio/room” in “Settings for the entire drum kit.”

## Settings for the entire drum kit

### ■ Selecting the studio/room

You can select one of 10 types of “ambiences” built into the TD-10. Before you make detailed settings, use this setting to select the basic type of acoustic environment in which you will be playing.

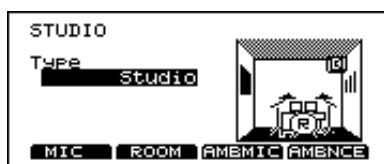

#### Procedure

1. Press [STUDIO].  
The “STUDIO” page will appear.
2. Use [INC/DEC] or the VALUE dial to make the setting.

#### Parameters

Studio Select: Beach, Living Room, Bath Room, Studio, Garage, Locker Room, Theater, Cave, Gymnasium, Dome Stadium

### ■ Changing the size of the room

You have five sizes to choose from.



#### Procedure

1. Press [STUDIO]-[F2 (ROOM)].  
The “ROOM” page will appear.
2. Use [CURSOR] to move the cursor to “Room Size.”
3. Use [INC/DEC] or the VALUE dial to make the setting.

#### Parameters

Room Sizes: Tiny, Small, Medium, Large, Huge

### ■ Changing the wall material

You can choose from Wood, Plaster or Glass covered walls for the room where the drums are being played.

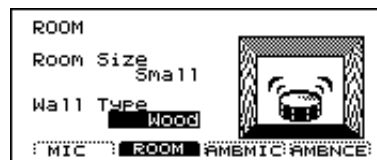

#### Procedure

1. Press [STUDIO]-[F2 (ROOM)].  
The “ROOM” page will appear.
2. Use [CURSOR] to move the cursor to “Wall Type.”
3. Use [INC/DEC] or the VALUE dial to make the setting.

#### Parameters

Wall Type: Wood, Plaster, Glass

- Wood: Simulates the sound of a wood-walled room producing a warm sound.
- Plaster: Simulates a plaster-walled room producing a more “naturally live” sound.
- Glass: Simulates a glass-walled room producing a very bright ambience.

### ■ Selecting the ambience mike location

Ambience microphones are placed at a distance from the instrument in order to pick up the natural acoustics of the room. Adjusting the height of these mikes allows you to capture different characteristics of that room.

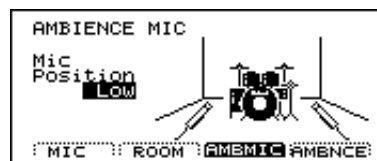

#### Procedure

1. Press [STUDIO]-[F3 (AMBMIC)].  
The “AMBIENCE MIC” page will appear.
2. Use [INC/DEC] or the VALUE dial to make the setting.

**Parameters**

Ambience Mic Positions: Low, High

Low: Often referred to as “floor mikes,” picking up low frequencies of the room, producing a warmer character.

High: Often referred to as “overhead mikes” capturing the high frequencies and accenting the brightness of the room.

**■ Adjusting the volume and output assignments of the ambience**

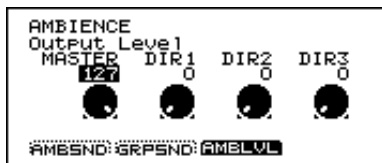

**Procedure**

1. Press [STUDIO]-[F4 (AMBNC)]-[F3 (AMBLVL)]. The “AMBIENCE” page will appear.
2. Use [CURSOR] to move the cursor to the output destination that you wish to set (“MASTER”, “DIR1”, “DIR2”, “DIR3”).
3. Use [INC/DEC] or the VALUE dial to make the setting. If you want the ambience to be output ONLY from a specific output, raise the value for that output and set a value of “0” for the others.

**Parameters**

Ambience Output Level: 0–127

MASTER: Adjusts the level of ambience output from the MASTER jacks.

DIR1: Adjusts the level of ambience output from the DIRECT 1 jacks.

DIR2: Adjusts the level of ambience output from the DIRECT 2 jacks.

DIR3: Adjusts the level of ambience output from the DIRECT 3 jacks.

\* Consider that Ambience is like an effect used with a mixing console and that these parameters correspond to the “Return Level” (the amount that is sent from an effect back to the mixer).

**Settings for each instrument**

**About the basic procedure**

In each page, when you hit the pad for which you wish to make settings, the setting page for that pad will appear. You can also make a selection by pressing [TRIG SELECT] on the TD-10 itself.

**■ Adjusting the amount of ambience**

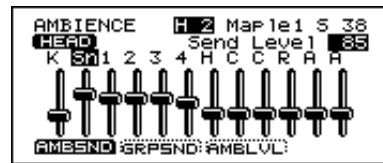

**Procedure**

1. Press [STUDIO]-[F4 (AMBNC)]-[F1 (AMBSND)]. The “AMBIENCE” page will appear.
2. Strike the pad that you wish to edit. The cursor will move to the slider of the pad that you struck.
3. Use the VALUE dial, [INC/DEC] or [CURSOR] to make the setting.

**Parameters**

Ambience Send Level: 0-127

\* If you consider Ambience as a type of “effect” used with a mixing console, this parameter corresponds to the Send Level (the amount that is sent from the mixer to the effect or in this case, the room you’ve selected).

**■ Selecting the type of mike and its location**

Here you can choose the type of mike used on certain instruments and its relative position to that instrument.

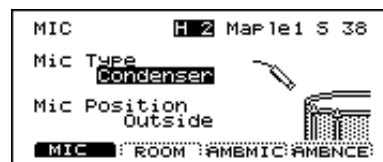

\* This parameter’s not available for electronic drums, TR-808/909 kits, cymbals or percussion.

Microphone settings can be made for the following trigger inputs.

Trigger number	Mic type	Mic location
1, 2 (KICK, SNARE)	o	o
3-6 (TOM1-4)	-	o
7-12	-	-

o: Can be set    -: Cannot be set



## ● Selecting the type of mike

### Procedure

1. Press [STUDIO]-[F1 (MIC)].  
The “MIC” page will appear.
2. Strike the pad that you wish to edit.  
The setting page for the pad you struck appears.
3. Use [CURSOR] to move the cursor to “Mic Type.”
4. Use [INC/DEC] or the VALUE dial to make the setting.

### Parameters

Mic Type: Condenser, Dynamic 1, Dynamic 2 (KICK)  
Condenser, Dynamic, Lo-Fi (SNARE)

#### (KICK)

Condenser: Produces the sound of a condenser mike.

Dynamic 1: Produces the sound of a standard dynamic mike.

Dynamic 2: Produces the sound of a dynamic mike that has the mid-to-high-range content emphasized somewhat.

#### (SNARE)

Condenser: Produces the sound of a condenser mike.

Dynamic: Produces the sound of a dynamic mike.

Lo-Fi: Emphasizes low range and is a bit “dirty.”

## ● Specifying the mike placement

### Procedure

1. Press [STUDIO]-[F1 (MIC)].  
The “MIC” page will appear.
2. Strike the pad that you wish to edit.  
The setting page for the pad you struck appears.
3. Use [CURSOR] to move the cursor to “Mic Position.”
4. Use [INC/DEC] or the VALUE dial to make the setting.

### Parameters

Mic Position: Outside, Standard, Inside

Outside: Placed to capture more “attack.”

Standard: Standard mike location for a natural sound.

Inside: Produces less attack and a bit more “body” of the drum.

## Settings for each group

Settings can be made for the three main instrument groups: the drum kit, the percussion group, and the backing parts.

\* *The percussion group is a sound map that can be accessed when the TD-10 is being used as a MIDI sound module. For details refer to “Using the percussion group” (p. 126). Of course, individual percussion sounds CAN be assigned to the pads.*

## ■ Adjusting the amount of ambience send level for each group

The ambience can be adjusted by groups: the drum kit, the percussion group (p. 126), and the backing part group. It’s a convenient way to raise or lower the overall amount of ambience without adjusting individual ambience send levels for the instruments.

### Procedure

1. Press [STUDIO]-[F4 (AMBNC)]-[F2 (GRPSND)].  
The “AMBIENCE” page will appear.
2. Use [CURSOR] to move the cursor to the group for which you wish to make settings (“DRUMS”, “PERC”, “PART” ).
3. Use [INC/DEC] or the VALUE dial to make the setting.

### Parameters

Ambience Group Send: 0–127

DRUMS: Adjusts ambience send level for the entire drum kit.

PERC: Adjusts ambience send level for the entire percussion group.

PART: Adjusts ambience send level for the sequencer parts (Part 1, Part 2, and Bass part).

# Chapter 5. Control room settings

The most important aspect of finalizing the sound in recording or live performances depends on the mixing console. In the Control Room, you'll find a complete 12-channel mixer with 10 individual compressors and EQ's and digital effects, finalizing your sound in a CD-quality state.

## Abbreviations in the display screen

TRIGGER INPUT jacks

K=Kick  
Sn=Snare  
T1=Tom 1  
T2=Tom 2  
T3=Tom 3  
T4=Tom 4  
HH=Hi-hat  
C1=Crash 1  
C2=Crash 2  
Rd=Ride cymbal  
A1=AUX1  
A2=AUX2

## Settings for each instrument

### The basic procedure

In each page, strike the pad that you wish to make settings, and the setting page for that pad will appear. You can also use [TRIG SELECT] to make your selection by.

## ■ Adjusting volume (level)

**HEAD RIM**

This adjusts the volume of each pad.

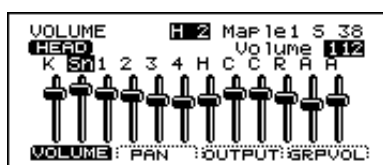

### Procedure

1. Press [CONTROL ROOM]-[F1 (MIXER)]-[F1 (VOLUME)]. The "VOLUME" page will appear.
2. Strike the pad that you wish to edit. The cursor will move to the slider of the pad that you struck.
3. Use the VALUE dial, [INC/DEC] or [CURSOR] to make the setting.

### Parameters

Volume: 0–127

## ■ Adjusting pan (stereo location)

This adjusts the stereo location of each pad.

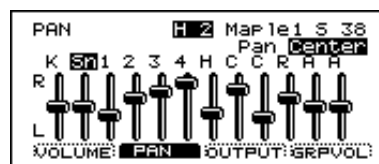

### Procedure

1. Press [CONTROL ROOM]-[F1 (MIXER)]-[F2 (PAN)]. The "PAN" page will appear.
2. Strike the pad that you wish to edit. The cursor will move to the slider of the pad that you struck.
3. Use the VALUE dial, [INC/DEC] or [CURSOR] to make the setting. Raising the slider (pressing [INC]) will move the sound toward the right, and lowering it (pressing [DEC]) will move the sound toward the left.

### Parameters

Pan: L15–Center–R15

## ■ Adjusting effect send level

**HEAD RIM**

This sets the effect Send Level for each pad/sound.

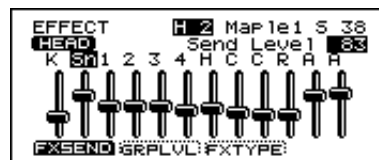

### Procedure

1. Press [CONTROL ROOM]-[F4 (EFFECT)]-[F1 (FXSEND)]. The "EFFECT" page will appear.
2. Strike the pad that you wish to edit. The cursor will move to the slider of the pad that you struck.
3. Use the VALUE dial, [INC/DEC] or [CURSOR] to make the setting.

### Parameters

Send Level: 0–127

## ■ Selecting output assignments

To change the output destination for the sound of each pad note that the vertical lines indicate the TRIGGER INPUT number, and the horizontal lines indicate the OUTPUT choices. The black dots indicate the OUTPUT assignment corresponding to each sound.

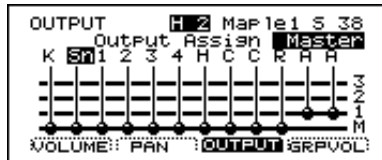

### Procedure

1. Press [CONTROL ROOM]-[F1 (MIXER)]-[F3 (OUTPUT)]. The "OUTPUT" page will appear.
2. Strike the pad that you wish to edit. The cursor will move to the vertical line (TRIGGER INPUT jack) of the pad that you struck.
3. Use the VALUE dial, [INC/DEC] or [CURSOR] to make the setting.

### Abbreviations in the display screen

#### OUTPUT jacks

- M=MASTER  
1=DIRECT 1  
2=DIRECT 2  
3=DIRECT 3

\* The volume of the DIRECT 1, DIRECT 2 and DIRECT 3 jacks is not affected by the master volume control located in the upper right of the front panel ([MASTER]).

### Applications

You can also use the DIRECT outputs (6) in mono by selecting (for example) DIRECT 1, and then panning the chosen sound hard right or left (R15/L15) (stereo location; p. 90). If you are processing all sounds externally, you can also use the MASTER out in this way, giving you 8 individual mono outs.

### Output Separation: 76 dB (min.)

(MASTER L -> DIRECT L, MASTER R -> DIRECT R): 45 dB (min.)  
(DIRECT L -> Other DIRECT L, DIRECT R -> Other DIRECT R): 45 dB (min.)

## ■ Controlling variations in volume (Compressor)

10 compressors are provided (Triggers 1-10 only) Compression is used to "smooth" volume peaks, preventing "overloads" and as it will also change the character and tone of the sound in response to the playing dynamics, it's another useful tool in creating YOUR sound.



### Procedure

1. Press [CONTROL ROOM]-[F2 (COMP)]. The "COMPRESSOR/LIMITER" page will appear.
2. Strike the pad that you wish to edit. The setting page for the pad you struck will appear.
3. Use [CURSOR] to move the cursor to the parameter that you wish to set.
4. Use [INC/DEC] or the VALUE dial to make the setting. In this page, [F1] will turn the compressor on/off. Also, pressing the [F2][F3][F4] buttons will move the cursor directly to "Attack," "Release," or "Output."

### Parameters

ATTACK (Attack time): 0.05–50 msec

Adjusts the volume of the attack (the beginning of the sound).

RELEAS (Release time): 0.05–2000 msec

Adjusts the release time of the sound.

OUTPUT (Output Level): -60– +12 dB

Adjusts the volume of the sound processed by the compressor. Ideally the volume should be about the same whether the compressor is on or off.

Threshold (Threshold): -∞, -99–0

When the input exceeds the level that you specify here, the compressor will begin to hold down the volume.

Ratio (Compression Ratio): 1:1–90:1, ∞:1

This decides the degree of volume compression, expressed as a ratio relative to the original (input) sound.

## ■ Customizing the tone (Equalizer)

Here you can adjust the high and low frequencies balance for the instrument assigned to each pad. (TRIGGERS 1-10 only)

\* This setting is not available for the AUX1,2 trigger inputs.

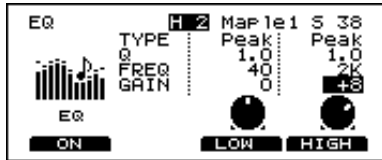

### Procedure

1. Press [CONTROL ROOM]-[F3 (EQ)].  
The "EQ" page will appear.
2. Strike the pad that you wish to edit.  
The setting page for the pad you struck will appear.
3. Use [CURSOR] to move the cursor to the parameter that you wish to set.
4. Use [INC/DEC] or the VALUE dial to make the setting.  
In this page, [F1] will turn the equalizer on/off. Pressing [F3] or [F4] will move the cursor directly to the low range (LOW) or high range (HIGH) settings.

### Parameters

TYPE: Peak, L shelv, H shelv

Peak: The vicinity of the specified frequency range will be boosted/cut.

L shelv: The entire range below the specified frequency will be boosted/cut.

H shelv: The entire range above the specified frequency will be boosted/cut.

Q: 0.5, 1.0–20, 1.0 steps

Adjusts the width of the frequency range that will be boosted/cut. For example, when the "Q" value is small, raising or lowering the low range "GAIN" will affect a broad area extending close to the high range.

FREQ (Frequency): 20–20 kHz

Adjusts the point at which the boost/cut will occur. If you wish to boost/cut a range that is higher than the current range, you would adjust this setting.

GAIN: -15–0–+15 dB

Adjusts the amount of the boost/cut. Negative (-) settings produce a cut.

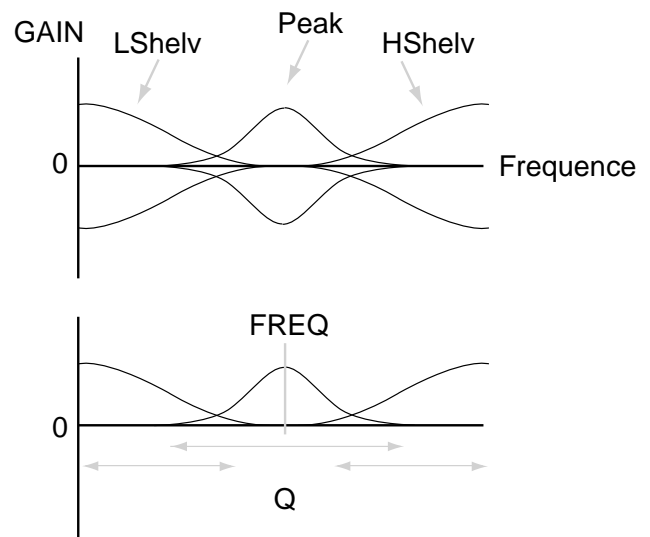

## Settings for the entire drum kit

### ■ Adjusting effect Return level

You can adjust the effect Return level for the drum kit, percussion group, and backing parts.

#### Procedure

1. Press [CONTROL ROOM]-[F4 (EFFECT)]-[F2 (SNDRTN)]. The "EFFECT GROUP" page will appear.
2. Use [CURSOR] to move the cursor to "Return Level"
3. Use [INC/DEC] or the VALUE dial to make the setting.

#### Parameters

Return Level: 0–127

### ■ Selecting the type of effect

The TD-10 provides 30 different types of digital effects that are easy to select with the simple push of a button. You can also edit these effects. Refer to "Editing the effects" (p. 94).



#### Procedure

1. Press [CONTROL ROOM]-[F4 (EFFECT)]-[F3 (FXTYPE)]. The "EFFECT TYPE" page will appear.
2. Use [CURSOR] to move the cursor to where the effect name is displayed.
3. Use [INC/DEC] or the VALUE dial to make the setting.

Hall Reverb 1, 2, 3

Room Reverb 1, 2, 3

Plate Reverb 1, 2, 3

These are high quality digital reverbs similar to what you find in dedicated effects modules. Hall and Room Reverbs are more conventional types while Plate simulates the predecessors of digital effects, where a metal plate was actually used. Try them to hear the differences.

Gate Reverb 1, 2, 3

Non Linear 1, 2

These effects cut off the reverberation before its natural decay, and have broad applications as the sound will change in different ways over time for Gate Reverb and Non Linear.

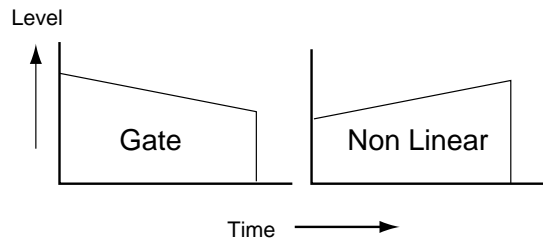

Delay 1, 2

A repeating-type effect is produced. By changing the time difference between the left and right delays, you can "spread out" the left/right width of the delayed sound.

Beat Delay 1, 2

This produces a delay that is synchronized to the tempo of the sequencer. This differs from "Delay 1, 2" in that the delay time can be specified in terms of note values. For example with a setting of "16" (16th note), the delay time will always be a 16th note length even if you change the tempo of the sequencer.

Chorus → Delay 1, 2

Delay is combined with a chorused sound.

Chorus: An effect that adds smoothness and spaciousness to the sound

Delay: A repeating-type effect

Flanger → Delay 1, 2

Delay is combined to a flanged sound.

Flanger: An effect that adds a "jet airplane" nuance

Delay: A repeating-type effect

Phaser → Delay 1, 2

Delay is applied to a phased sound.

Phaser: An effect that gives a twisting character to the sound

Delay: A repeating-type effect

Pitch Shift Delay 1, 2

These are delays with pitch change.

3D-Delay 1, 2, Flying 3D-Delay 1, 2

3D-Delay adds a sense of spaciousness to the delay sound. Flanging 3D-Delay produces an effect in which the delay sound appears to rotate front/rear and left/right.

\* Listen in a stereo environment to appreciate this 3D-Delay or Flying 3D-Delay effect. For the speaker placement locations, refer to p. 95.

## ■ Editing the effects

Here's how to set the parameters for each effect type. It's best to use Ambience to create the basic overall sound of the drum kit, and then use the digital effects to enhance specific sounds. To adjust the depth for each instrument, refer to p. 90.



### Procedure

1. Press [CONTROL ROOM]-[F4 (EFFECT)]. The "EFFECT TYPE" page will appear.
2. Use [CURSOR] to move the cursor to the parameter that you wish to set.
3. Use [INC/DEC] or the VALUE dial to make the setting.

### Parameters for Hall Reverb 1, 2, 3 / Room Reverb 1, 2, 3 / Plate Reverb 1, 2, 3

Reverb Time: 0.1–25 (sec)  
The length of reverberation.

Pre Delay: 0–200 (ms)  
Adjust the time until the reverb begins to sound. This is a small and precise adjustment and will appear to affect the fatness of the reverb, rather than being felt as a change in the reverb decay time.

High Cut Freq: 500–20k (Hz)  
Adjust the tone of the reverb to make it brighter/darker. Lowering this frequency will cut more of the high range, making the sound darker.

Spread: 0–15  
Adjust the left/right spread of the reverb. Higher settings will create a more obvious "spread" in the sound.

### Parameters for Gate Reverb 1, 2, 3 / Non Linear 1, 2

Gate Time: 10–400 (ms)  
Adjust the length of the reverb.

Pre Delay: 0–200 (ms)  
Adjust the time until the reverb begins to sound. This is a small and precise adjustment and will appear to affect the fatness of the reverb, rather than being felt as a change in the reverb decay time.

High Cut Freq: 500–20k (Hz)  
Adjust the tone of the reverb to make it brighter/darker. Lowering this frequency will cut more of the high range, making the sound darker.

Density: 0–127  
Adjust the "fatness" of the reverb. Higher settings produce a fatter (denser) reverb.

### Parameters for Delay 1, 2

Delay Time: 0–1200 (ms)  
Adjust the time from the original sound until the delay is heard.

Shift: L1200–0–R1200 (ms)  
Adjust the time difference between the left and right delays. For example: if Delay Time is set to 400ms, setting Shift to L100ms will cause the right channel delay to remain at 400ms and the left channel delay will sound at 400+100=500ms. You can not make settings that would cause the sum of Delay Time and Shift to be greater than 1200ms.

Feedback Level: 0–127  
Adjust the number of times that the delay effect repeats.

High Damp Freq: 500–20k (Hz)  
Adjust the tone of the delay to make it brighter/darker. Lowering this frequency will cut more of the high range, making the sound darker.

### Parameters for Beat Delay 1, 2

Delay Time: 16, 8T, 16F, 8, 4T, 8F, 4, 2T, 4F, 2  
Specify the note value at which the delay will repeat.

Delay Time values	
16:	16th notes
8T:	8th note triplets
16F:	dotted 16th notes
8:	8th notes
4T:	quarter note triplets
8F:	dotted 8th notes
4:	quarter note
2T:	half-note triplets
4F:	dotted quarter note
2:	half note

Shift: L2, L4F, L2T, L4, L8F, L4T, L8, L16F, L8T, L16, 0, R16, R8T, R16F, R8, R4T, R8F, R4, R2T, R4F, R2  
Specify how much the right or left channel delay will be later than the Delay Time.

For example if Delay Time is set to "16 (16th note)" and Shift is set to "L16" (left channel delayed by a 16th note), the right channel delay will be heard at 16th note timing, and the left channel will be heard one 16th note later than this. You can not make settings that would cause the sum of Delay Time and Shift to be greater than 1200ms.

Feedback Level: 0–127  
Adjust the number of times that the delay repeats.

High Damp Freq: 500–20k (Hz)  
Adjust the tone of the delay to make it brighter/darker. Lowering this frequency will cut more of the high range, making the sound darker.

**Parameters for Chorus → Delay 1, 2**

Rate: 0.1–10.0(Hz)

Adjust the modulation frequency of the chorus. Higher settings produce faster modulation.

Depth: 0–127

Adjust the modulation depth of the chorus. Higher settings produce a stronger effect.

Delay Time: 0–500 (ms)

Adjust the time from the original sound until when the delay is heard.

Delay Feedback: 0–127

Adjust the number of times that the delay repeats.

*\* If you wish to use only the chorus, set Delay Time and Delay Feedback to 0(off).*

**Parameters for Flanger → Delay 1, 2**

Rate: 0.1–10.0 (Hz)

Adjust the modulation frequency of the flanger. Higher settings produce faster modulation.

Depth: 0–127

Adjust the depth of the flanger. Higher settings increase the effect.

Delay Time: 0–500 (ms)

Adjust the time difference from the original sound until the delay is heard.

Delay Feedback: 0–127

Adjust the number of times that the delay repeats.

*\* If you want to just use the flanger, set Delay Time & Delay Feedback to 0.(off)*

**Parameters for Phaser → Delay 1, 2**

Rate: 0.1–10.0 (Hz)

Adjust the modulation frequency of the phaser. Higher settings produce faster modulation.

Depth: 0–127

Adjust the modulation depth of the phaser. Higher settings produce a stronger effect.

Delay Time: 0–500 (ms)

Adjust the time from the original sound until the delay is heard.

Delay Feedback: 0–127

Adjust the number of times that the delay effect repeats.

*\* If you wish to use just the phaser effect, set Delay Time & Delay Feedback to 0.*

**Parameters for Pitch Shift Delay 1, 2**

Pitch Shift: -12–0–+12 (semitones)

Specify the amount of pitch change. A setting of +1 raises the pitch a semitone, and +12 raises the pitch one octave.

Delay Time: 0–500 (ms)

Adjust the time from the original sound until the delay is heard.

Feedback Level: 0–127

Adjust the number of times that the delay repeats. With settings of 2 or more times, the pitch-shifted sound will be pitch-shifted again, meaning that the pitch will rise (or fall) by the specified Pitch Shift amount each time the delay repeats.

High Cut Freq: 500–20k (Hz)

Adjust the tone of the delay to make it brighter/darker. Lowering this frequency will cut more of the high range, making the sound darker.

**Parameters for 3D-Delay 1, 2**

Delay Time: 0–1200 (ms)

Adjust the time from the original sound until the delay is heard.

Shift: L1200–0–R1200 (ms)

Relative to the Delay Time, you can lengthen the time until the right or left channel delay is heard.

For example if Delay Time is set to 400ms, setting Shift to L100ms will cause the right channel delay to remain at 400ms and the left channel delay will sound 100 ms later. You can not make settings causing the sum of Delay Time and Shift to be greater than 1200ms.

Feedback Level: 0–127

Adjust the number of times that the delay effect repeats.

Speaker Angle: 0–90

Leaving the actual speaker locations as they are, you can adjust "Angle" in the following diagram to change the direction from which the sound is heard.

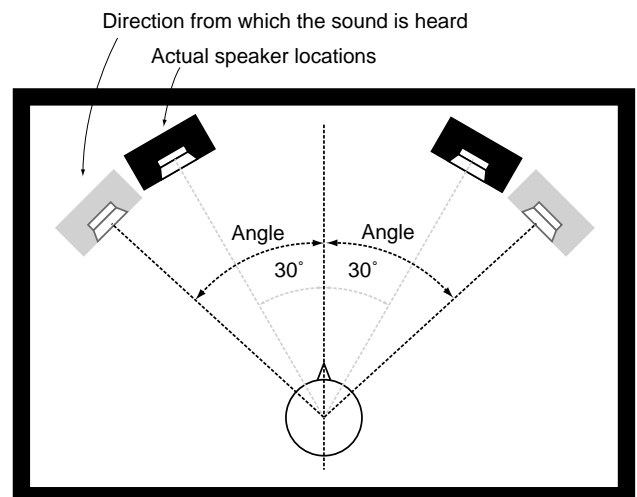

### Parameters for Flying 3D-Delay 1, 2

Delay Time: 10–1200 (ms)

Adjust the time from the original sound until the delay is heard.

Feedback Level: 0–127

Adjust the number of times that the delay repeated.

Rotation: -150–0– +150 (R.P.M) (steps of 3)

Specify the number of rotations per minute. Positive (+) settings rotate toward the right, negative (-) settings rotate toward the left.

High EQ Gain: 0– +10

This is an equalizer that is applied only to the delay sound.

## Settings for an entire group

---

Broad Settings can be made for the entire drum kit, backing parts, or percussion group.

\* *The percussion group is a sound map that can be accessed when the TD-10 is being used as a MIDI sound module. For details refer to “Using the percussion group” (p. 126). Of course, individual percussion sounds CAN be assigned to the pads.*

### ■ Adjusting effect send level for an entire group

You can adjust the overall amount of effect send level for the drum kit, percussion group (p. 126), and backing parts.

#### Procedure

1. Press [CONTROL ROOM]-[F4 (EFFECT)]-[F2 (SNDRTN)]. The “EFFECT GROUP” page will appear.
2. Use [CURSOR] to move the cursor to the group (“Drums,” “Perc,” or “Part”) for which you wish to make settings.
3. Use [INC/DEC] or the VALUE dial to make the setting.

#### Parameters

Group FX Send: 0–127

Drums: The amount of effect send level for the entire drum kit.

Perc: The amount of effect send level for the entire percussion group.

Part: The amount of effect send level for the sequencer parts (part 1, part 2, bass part).

### ■ Adjusting the volume by group

You can adjust the overall volume of the drum kit and percussion group.

#### Procedure

1. Press [CONTROL ROOM]-[F1 (MIXER)]-[F4 (GRPVOL)]. The “GROUP VOLUME” page will appear.
2. Use [CURSOR] to move the cursor to the group for which you wish to make settings (“DRUMS” or “PERC”).
3. Use [INC/DEC] or the VALUE dial to make the setting.

#### Parameters

Group Volume: 0–127

DRUMS: Adjusts the volume of the entire drum kit.

PERC: Adjusts the volume of the entire percussion group.



# Chapter 6. Sequencer

The TD-10's sequencer consists of four parts (like 4 tracks). The Drum part is used to record/ play back performance from the pads or an external MIDI controller. There are three other parts for melodic instruments: Part 1, Part 2 and the Bass part.

A set of performances for each of these four parameters is collectively referred to as a pattern.

The Preset patterns (1-50) contain pre-recorded performances for each part and can be used for listening, or as a practice/performance tool. Preset patterns cannot be erased (p. 104) or recorded over. The User patterns (51-100) can be used for recording. In order to record melodic instruments on Part 1, Part 2 and the Bass part, you will need to use an external MIDI keyboard. Recording the Drum part can be done from the pads or an external MIDI controller.

## Basic sequencer operation

The "SEQUENCER" buttons located on the front panel are used to perform basic operations and access the setting pages. Pressing [PATTERN] will call up the basic display page of the sequencer.

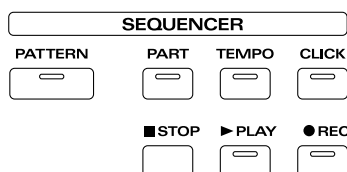

[PATTERN]: Select patterns. This is the basic display page for the sequencer.

[PART]: Make settings for each Part.

[TEMPO]: Set the Tempo.

[CLICK]: Turn the click sound on/off.

[STOP]: Pressing this will stop playback. Pressing it once again returns you to the beginning of the song.

[PLAY]: Start sequencer playback.

[REC]: Access the recording setting page, and enter record-standby mode.

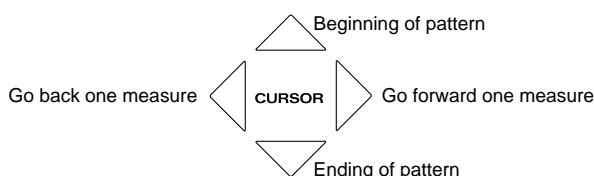

[CURSOR]: Press the left button to rewind, and the right button to fast-forward. Press the up button to move to the beginning of the pattern, and the down button to move to the end.

For details on the operation of each button, refer to the explanations that follow.

## Using Preset Patterns

It is not possible to modify the settings of a preset pattern. If you attempt to modify the settings when a preset pattern is selected, the following display will appear.

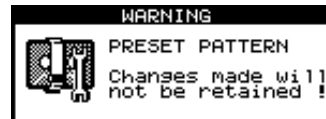

Although the settings can be modified temporarily, the original settings will return when you select another pattern. If you wish to modify the settings of a preset pattern, you must first copy the preset pattern to a User pattern (p. 104).

## Setting the tempo

### Setting the tempo for each pattern

When a pattern is selected, the tempo you specify here will be set automatically.

#### Procedure

1. Press [PATTERN]-[F2 (FUNC)]-[F2 (SETUP)].

The "PATTERN SETUP" page will appear.

2. Use [CURSOR] to move the cursor to "Pattern Tempo."

3. Use [INC/DEC] or the VALUE dial to set the tempo.

#### Parameters

Pattern Tempo: 20-260

### Temporarily changing the tempo of the currently-playing pattern

You can change the tempo of the pattern that is currently being played back. When you select a different pattern, this tempo change will be canceled.

#### Procedure

1. Press [TEMPO].

The "TEMPO" page will appear.

2. Use [INC/DEC] or the VALUE dial to set the tempo.

#### Parameters

TEMPO: 20-260

## Playback functions

### ■ Selecting a pattern

#### Procedure

1. Press [PATTERN].
2. Use [INC/DEC] or the VALUE dial to select a pattern.

#### About the screen display

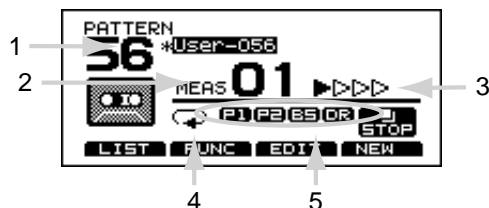

1. Currently selected pattern number
2. Currently playing measure number.
3. Indicates the beat.
- 4, 5 show the status of settings that were made in other setting displays.
4. Indicates the playback method setting.
5. Indicates the part mute status (p. 107).

\* Function buttons [F1]–[F4] are used for various functions as explained below.

### ■ Selecting patterns from the list

Like the “PATTERN” page, here you can select patterns from a list of names.

From the left, this indicates pattern name (Name), time signature (Beat), measure length (Len), and pattern type (Type).



#### Procedure

1. Press [PATTERN]-[F1 (LIST)].  
The “PATTERN LIST” page will appear.
2. Use the VALUE dial, [INC/DEC] or [CURSOR] to select a pattern.

#### Function buttons

- [F1 (PAGE ▲)]: The previous page of the list will appear.
- [F2 (PAGE ▼)]: The next page of the list will appear.
- [F3 (MEMORY)]: This indicates the remaining amount of memory and the number of patterns.
- [F4 (NEW)]: The empty pattern will be selected.

### ■ Selecting how a pattern will playback

There are three different ways to make a pattern play back.

**Loop:** The pattern will playback, repeating until you press [STOP].

**One Shot:** The pattern will playback once and then stop.

**Tap:** See (p. 119), This allows you to play back a pattern note by note (step by step) (You can press [PLAY] to audition this.)

#### Procedure

1. Press [PATTERN]-[F2 (FUNC)]-[F3 (TYPE)].  
The “PATTERN TYPE” page will appear.
2. Use [CURSOR] to move the cursor to “Play Type.”
3. Use [INC/DEC] or the VALUE dial to make the setting.

#### Parameters

Play Type: Loop, One Shot, Tap

#### Ways to use this function

**Loop:** Loop is useful for practicing and live performance.

**One Shot:** One Shot is also a great live performance feature.

With Loop and One Shot-each time you hit the pad to which the pattern is assigned, it will automatically start from the beginning of the pattern. It's a good idea to actually try this out to see for yourself.

You can use an empty pattern assigned to a pad to function as a “stop” switch for a pattern triggered from another pad.

\* *QuickPlay* is a supplementary function for Loop and One Shot. *QuickPlay* starts playback of the pattern from the first note (first event) even if when you recorded the pattern, you left a pause at the beginning. For example if you had just played/recorded freely, ignoring the tempo clock.

Tap: This function is a great performance tool! For example if you specify “Tap” for a pattern which contains a melody line and assign this pattern to a pad, you can play the notes of the melody in order each time you strike the pad. You can set the “Reset Time” so that the pattern will automatically return to the beginning if that time interval elapses without that pad being hit again. For example, you can play a bass line with your kick drum and the two sounds will be perfectly “tight.”

\* *Reset Time (Off, 0.1–4.0 seconds)*

*This is the time interval that resets the pattern being used. If it is set to “Off,” this function will be disabled.*

## Click settings

### ■ Click on/off and volume settings

When you press [CLICK], the click will be turned on/off. To adjust the volume, move the [GROUP FADERS] slider [CLICK].

### ■ Setting the tempo

While pattern playback is halted, you can use the click as a metronome. But if a different pattern is selected, the tempo will change to the tempo specified for that pattern.

#### Procedure

1. Press [TEMPO].  
The “TEMPO” page will appear.
2. Use [INC/DEC] or the VALUE dial to set the tempo.

#### Parameters

TEMPO: 20–260

### ■ Setting the time signature and click interval

#### Procedure

1. Press [CLICK]-[F1 (INTRVL)].  
The “CLICK” page will appear.
2. Use [CURSOR] to move the cursor to the parameter that you wish to set.
3. Use [INC/DEC] or the VALUE dial to make the setting.

\* *It is not possible to change the time signature of the click while a pattern is playing back. The click corresponds to the time signature of the pattern.*

#### Parameters

Time Signature: Numerator = 0–13 (number of beats per measure), Denominator = 2, 4, 8, 16 (basic note value)

Interval: 1/2 (half note), 3/8 (dotted quarter note), 1/4 (quarter note), 1/8 (eighth note), 1/12 (12th note), 1/16 (16th note)

### ■ Selecting the click sound

You have a choice of sixteen sounds including a human voice!

#### Procedure

1. Press [CLICK]-[F2 (INST)].

The “CLICK” page will appear.

2. Use [CURSOR] to move the cursor to “Inst.”
3. Use [INC/DEC] or the VALUE dial to make the setting.

#### Parameters

Inst: Voice, Click, Claves, Wood Block, Triangle, Cowbell, Conga, Talking Drum, Maracas, Cabasa, Cuica, Agogo, Tambourine, Snaps, 909 Snare, 808 Cowbell

### ■ Using ambience

You can also send the click sound to the ambience used in the current kit.

#### Procedure

1. Press [CLICK]-[F2 (INST)].

The “CLICK” page will appear.

2. Use [CURSOR] to move the cursor to “Ambience Level.”
3. Use [INC/DEC] or the VALUE dial to make the setting.

#### Parameters

Ambience Level: 0–127

### ■ Using effects

You can also “send” the click sound to the effect in use, and sometimes this makes it more comfortable to listen to.

When using this, make sure that the master effect switch is ON (p. 41).

#### Procedure

1. Press [CLICK]-[F2 (INST)].

The “CLICK” page will appear.

2. Use [CURSOR] to move the cursor to “FX Send Level.”
3. Use [INC/DEC] or the VALUE dial to make the setting.

#### Parameters

FX Send Level: 0–127

\* *The effect is the one assigned to the kit ([CONTROL ROOM]-[F4 (EFFECT)]).*

### ■ Adjusting the pan (stereo location)

You can set the pan position of the click. But if you have chosen headphones (Phones Only) as the output destination, the click will be located in the center regardless of this setting.

#### Procedure

1. Press [CLICK]-[F2 (INST)].

The “CLICK” page will appear.

2. Use [CURSOR] to move the cursor to “Pan.”
3. Use [INC/DEC] or the VALUE dial to make the setting. “L15” is far left, “Center” is center, and “R15” is far right.

#### Parameters

Pan: L15–Center–R15

### ■ Selecting the output destination

You can select the output for the click. (Master and/or Headphones only)

#### Procedure

1. Press [CLICK]-[F2 (INST)].

The “CLICK” page will appear.

2. Use [CURSOR] to move the cursor to “Output.”
3. Use [INC/DEC] or the VALUE dial to make the setting.

#### Parameters

Output: Master, Phones Only

Master: Output from the MASTER OUT and PHONES jacks.

Phones Only: Output only from the PHONES jacks.

## Recording

Performance on the pads or on an external MIDI keyboard can be recorded. On the TD-10, your performance will be recorded exactly as you play it, including hi-hat control pedal movements and Positional Sensing.

- \* *Brush swish/sweeping and choke (p. 35) cannot be recorded.*
- \* *Please keep in mind that even though there are 50 user patterns, the amount of memory available will be determined by how much data is recorded into each pattern.*

### Basic recording procedure

The procedure is the same when recording with pads or with a MIDI keyboard.

#### 1. Select an empty pattern



#### Procedure

1. Press [PATTERN]-[F4 (NEW)].  
An empty pattern is automatically selected.
- \* *If all of the patterns have been used, this can't be selected. Refer to "Clearing a pattern" (p. 105) and erase an unwanted pattern before you record.*

#### 2. Set the time signature and the number of measures



#### Procedure

1. Press [PATTERN]-[F2 (FUNC)]-[F2 (SETUP)].  
The "PATTERN SETUP" page will appear.
2. Use [CURSOR] to move the cursor to the parameter that you wish to set.
3. Use [INC/DEC] or the VALUE dial to make the setting.

#### Parameters

Time Signature: Numerator = 1–13, Denominator = 2, 4, 8, 16  
Length (bars): 1–99

- \* *When the denominator is 16, you cannot set a numerator of from 1 through 3. Also, with a denominator of 8, a numerator of 1 cannot be set.*
- \* *If you are using Replace recording (p. 102), it is not necessary to specify the Length. Recording will continue until you press [STOP], and the number of measures recorded will automatically become the "Length" setting.*

If you are recording from the pads, disregard paragraphs 3 and 4 of this section.

#### 3. Select a MIDI channel

Be sure that the transmit channel on your keyboard corresponds to the MIDI channel of the part you wish to play/record.

Each of the 4 parts has its own MIDI channel. The factory preset channels are as follows:

- All Drums = MIDI 10
- Part 1 = MIDI Ch 5
- Part 2 = MIDI Ch 6
- Bass Part = MIDI Ch 2

(You can change the MIDI channels if you wish-Press [SETUP], then [F2 (MIDI)].)

#### 4. Select an instrument



#### Procedure

1. Press [Part]-[F1 (INST)].  
The "PART INST" page will appear.
2. Press [F1]–[F3] to select the part that you wish to record.  
The [F1]–[F3] buttons select Part 1, Part 2, and Bass part respectively.
3. Use [CURSOR] to move the cursor to "INST."
4. Use [INC/DEC] or the VALUE dial to select a backing instrument or drum kit.

## 5. Specify the recording method



### Procedure

1. Press [PATTERN]-[REC].  
The "REC STANDBY" page will appear.
2. Use [CURSOR] to move the cursor to "Rec Mode."
3. Use [INC/DEC] or the VALUE dial to specify the recording method.

### Parameters

Rec Mode: Loop All, Loop 1, Loop 2, Loop 4, Loop 8, Replace

Loop All: The entire pattern will be repeated, and on each pass your performance will be added, ("over-dubbed") and mixed with what you did previously.

Loop 1, Loop 2, Loop 4, Loop 8:

This determines the length of the section you are recording, and 1,2,4 or 8 measure sections will repeat.

Replace: Recording will continue until you press [STOP]. Any previously recorded data for all Parts will be erased.

## 6. Set the tempo

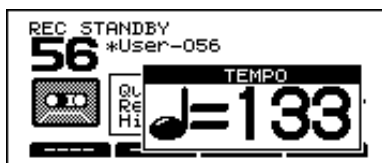

### Procedure

1. Press [TEMPO].  
The "TEMPO" page will appear.
2. Use [INC/DEC] or the VALUE dial to set the tempo.

## 7. Record

### Procedure

1. In record-standby mode (the "REC STANDBY" page), press [PLAY].  
Recording will begin.
2. When you finish recording, press [STOP].

## ■ The Rehearsal function

During recording you can press [REC] to switch between recording and rehearsal modes. This allows you to try out different sounds, fills or phrases without stopping the playback of the sequencer.

### Procedure

1. Begin recording.
2. During recording, press [REC].  
The [REC] indicator will begin blinking. In this condition, your performance on the pads (or MIDI keyboard) will not be recorded.
3. Press [REC] once again to return to recording mode.

## ■ Using a count-in

You can set a "count-in" (1 or 2 measures) to be heard before playback or recording.

### Procedure

1. Press [CLICK]-[F3 (COUNT)].
2. If you want a count-in for playback, select "PLAY." For recording, select "REC."
3. Use [INC/DEC] or the VALUE dial to make the setting.

### Parameters

PLAY: OFF, 1 meas, 2 meas

REC: OFF, 1 meas, 2 meas

OFF: Playback/recording will begin without a count-in.

1 meas: Playback/recording begins after a 1-measure count-in.

2 meas: Playback/recording begins after a 2-measure count-in.

## ■ Start recording the moment that you strike a pad

This function starts the recording process the instant you strike a pad.

### Procedure

1. Press [PATTERN]-[REC].  
The "REC STANDBY" page will appear and you are in record-standby mode as the click starts to play.
2. Use [CURSOR] to move the cursor to "Hit Pad Start."
3. Use [INC/DEC] or the VALUE dial to turn the setting "ON."

### Usage

In record-standby mode, recording starts the instant you strike a pad.

## ■ Correcting timing as you record (Quantize)

Quantize is a function that corrects inaccuracies of timing while you record. Specify the basic note value before you begin recording, and your performance will be quantized automatically to the set interval.



### Procedure

1. Press [PATTERN]-[REC].  
The "REC STANDBY" page appears and you're in record-standby mode as the click starts to play.
2. Use [CURSOR] to move the cursor to "Quantize."
3. Use [INC/DEC] or the VALUE dial to make the setting.

### Parameters

Quantize: (8th note), (8th note triplets), (16th note), (16th note triplets), (32nd note), (32nd note triplets), (64th note), OFF

## ■ Importing data from another sequencer into the TD-10

Data created on another sequencer can be imported via the MIDI IN and recorded on the TD-10's sequencer. The three melodic tracks and one drum track can be imported simultaneously. You will need to make settings for MIDI channels and MIDI synchronization.

### Procedure

1. Press [SETUP]-[F2 (MIDI)].  
The "MIDI" page will appear.
2. Set the MIDI channel of the TD-10 to match the MIDI channel of the transmitting device (refer to p. 124).
3. Press [PATTERN]-[F2 (FUNC)]-[F1 (GLOBAL)].  
The "PATTERN GLOBAL" page will appear.
4. Use [INC/DEC] or the VALUE dial to select "Auto."
5. Press [PATTERN]-[REC].  
The "REC STANDBY" page appears and you're in record-standby mode as the click starts to play.
6. Use [CURSOR] to move the cursor to "Rec Mode."
7. Use [INC/DEC] or the VALUE dial to "Replace."
8. Begin playback on the transmitted device. The TD-10 will begin recording in synchronization.

9. When the portion to be imported has been recorded, stop playback on the external sequencer and the TD-10 will stop recording.

## Editing a pattern

### ■ Naming a pattern

Each pattern can be given a name of up to 8 characters.

### Procedure

1. Press [PATTERN]-[F2 (FUNC)]-[F4 (NAME)].  
The "PATTERN NAME" page will appear.
2. Use [CURSOR] (left/right) to select the character you wish to change. The blinking location is the character that can be changed.  
The blinking location is the character that can be changed.
3. Use the VALUE dial, [INC/DEC], or [CURSOR] (up/down) to change the character.  
Characters can be selected in the order shown in the bottom of the screen.

### Function buttons

In this page, the [F1]-[F4] buttons perform convenient functions for entering characters.

- [F1 (INSERT)]: All characters to the right of the cursor will be moved to the right.
- [F2 (DELETE)]: The character at the cursor location will be deleted, and all characters to the right of the cursor will be moved to the left.
- [F3 (SPACE)]: A blank space will be inserted at the cursor location.
- [F4 (CHAR)]: Cycle between uppercase/lowercase/symbols.

## Erasing a pattern

This function erases ONLY the performance data; other settings (such as the number of measures and the time signature) stay the same.

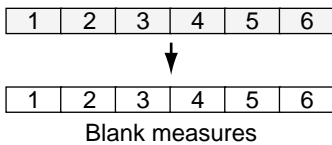
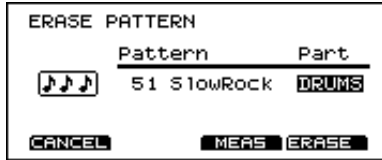

### Procedure

1. Press [PATTERN]-[F3 (EDIT)]-[F1 (ERASE)]. The “ERASE PATTERN” page will appear.
2. Use [CURSOR] to move the cursor to “Pattern.”
3. Use [INC/DEC] or the VALUE dial to select a pattern number.
4. Use [CURSOR] to move the cursor to “Part.”
5. Use [INC/DEC] or the VALUE dial to select the part that you wish to erase.
6. Press [F4 (ERASE)]  
A confirmation display will appear.
7. Press [F4 (EXEC)] and the data will be erased from the selected pattern. (Press [F1(CANCEL)] to return to the previous page without executing the operation.)

## Erasing selected measures of a pattern

Performance data can be erased from specified measures of a part or pattern. The erased portion will become blank measures allowing you to re-record in the same area

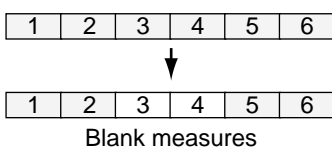
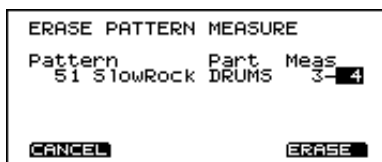

### Procedure

1. Press [PATTERN]-[F3 (EDIT)]-[F1 (ERASE)]-[F3 (MEAS)]. The “ERASE PATTERN MEASURE” page will appear.
2. Select the portion you wish to erase. Use [CURSOR] to move the cursor to the various settings.  
From the left, the display indicates the pattern, part, first measure, and last measure.
3. Use [INC/DEC] or the VALUE dial to make the setting.
4. Press [F4 (ERASE)]  
A confirmation display will appear.
5. Press [F4 (EXEC)] and the data will be erased from the specified area (Press [F1 (CANCEL)] to return to the previous page without executing the operation.)

## Copying a pattern

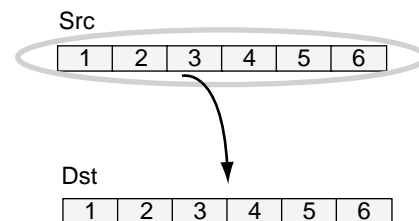
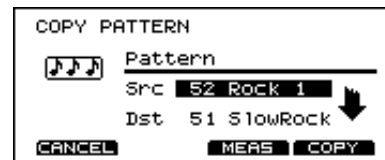

### Procedure

1. Press [PATTERN]-[F3 (EDIT)]-[F2 (COPY)]. The “COPY PATTERN” page will appear.
2. Use [CURSOR] to move the cursor to “Src.”
3. Use [INC/DEC] or the VALUE dial to select the copy source pattern.
4. Use [CURSOR] to move the cursor to “Dst.”
5. Use [INC/DEC] or the VALUE dial to select the copy destination pattern.
6. Press [F4 (COPY)]  
A confirmation display will appear.
7. Press [F4 (EXEC)] and the selected pattern will be copied. (If you press [F1(CANCEL)], you will return to the previous page without executing the operation.)



## ■ Copying selected measures of a pattern

You can copy selected measures of a part or pattern. Unlike copying an entire pattern, settings such as instrument and part volume etc. will not be copied; only the performance data will be copied.

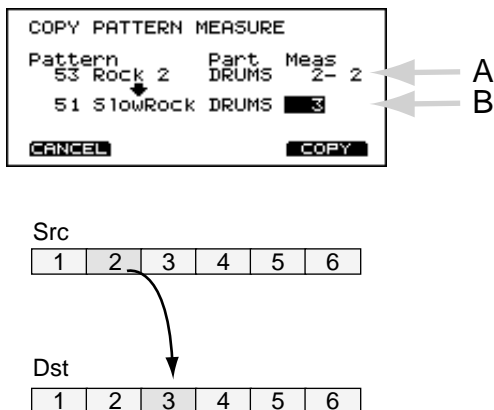

### Procedure

1. Press [PATTERN]-[F3 (EDIT)]-[F2 (COPY)]-[F3 (MEAS)]. The "COPY PATTERN MEASURE" page will appear.
2. In location "A" of the screen, select the data you wish to copy. Use [CURSOR] to move the cursor to the various settings.  
From the left, the display will indicate the pattern, part, first measure, and last measure.
3. Use [INC/DEC] or the VALUE dial to make the settings.
4. In location "B" of the screen, select the copy destination. Use [CURSOR] to move to the various settings. The display indicates the pattern number, track, and starting measure.

\* Beginning at the first measure which you specify here, the number of measures that the copy source occupies will be overwritten.

5. Use [INC/DEC] or the VALUE dial to make the settings.
6. Press [F4 (COPY)]  
A confirmation display will appear.
7. Press [F4 (EXEC)] and the specified portion of performance data will be copied. (Press [F1 (CANCEL)] to return to the previous page without executing the operation.)

## ■ Clearing a pattern

This operation deletes ALL data from a pattern, returning all parameters (time signature, length, tempo) to their default values.

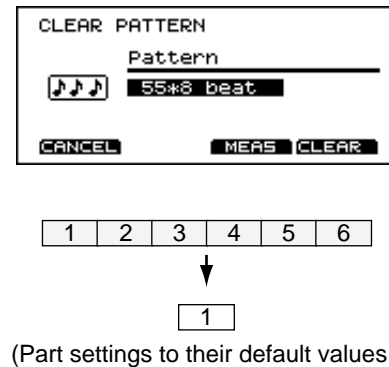

### Procedure

1. Press [PATTERN]-[F3 (EDIT)]-[F3 (CLEAR)]. The "CLEAR PATTERN" page will appear.
2. Use [INC/DEC] or the VALUE dial to select the pattern number that you wish to clear.
3. Press [F4 (CLEAR)]  
A confirmation display will appear.
4. Press [F4 (EXEC)] and the contents of the selected pattern will be erased. (Press [F1 (CANCEL)] to return to the previous page without executing the operation.)

## ■ Clearing selected measures of a pattern

This operation lets you clear (delete) selected measures in a pattern. After executing CLEAR, the length of the pattern will become shorter.

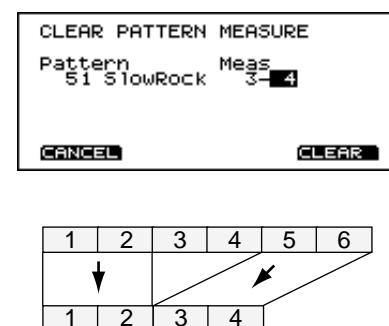

### Procedure

1. Press [PATTERN]-[F3 (EDIT)]-[F3 (CLEAR)]-[F3 (MEAS)]. The "CLEAR PATTERN MEASURE" page will appear.
2. Select the pattern and measures that you wish to clear. Use [CURSOR] to move the cursor to the various settings.  
From the left, the display indicates the pattern, the first measure, and the last measure.

3. Use [INC/DEC] or the VALUE dial to make the settings.
4. Press [F4 (CLEAR)]  
A confirmation display will appear.
5. Press [F4 (EXEC)] and the contents of the selected measures will be cleared. (Press [F1 (CANCEL)] to return to the previous page without executing the operation.)

## ■ Connecting two patterns

This operation connects two patterns to create one pattern. The pattern specified as “Dst” will be first, and the pattern specified as “Src” will be connected to it. The new pattern will be created in “Dst.”

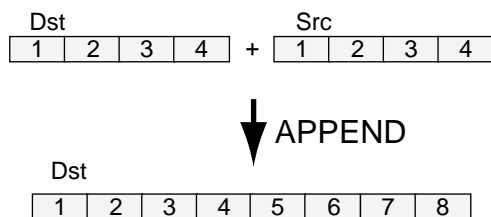
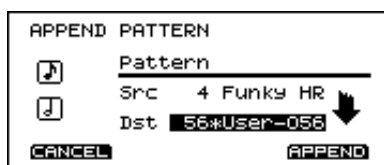

### Procedure

1. Press [PATTERN]-[F3 (EDIT)]-[F4 (APPEND)].  
The “APPEND PATTERN” page will appear.
2. Use [CURSOR] to move the cursor to “Src.”
3. Use [INC/DEC] or the VALUE dial to select the pattern that will come later.
4. Use [CURSOR] to move the cursor to “Dst.”
5. Use [INC/DEC] or the VALUE dial to select the pattern that will come first.
6. Press [F4 (APPEND)]  
A confirmation display will appear.
7. Press [F4 (EXEC)] and the patterns will be connected as specified above. (Press [F1 (CANCEL)] to return to the previous page without executing the operation.)

\* If the result of connecting the patterns would exceed 99 measures, the display will indicate “99 MEASURE MAXIMUM,” and the APPEND operation will not be executed.

## Settings for part instruments

\* Drum part settings cannot be made here. These settings are made in the Control Room of the drum kit. (refer to p. 90–96).

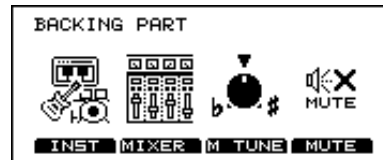

## ■ Adjusting the master tuning

Here you can adjust the overall tuning for Part 1, Part 2, and the Bass part.

### Procedure

1. Press [PART]-[F3 (M TUNE)].  
The “MASTER TUNE” page will appear.
2. Use [INC/DEC] or the VALUE dial to make the setting.

### Parameters

Master Tune: 415.3–466.2, 0.1 Hz steps

\* Pressing [F4 (440 HZ)] will set this to standard pitch (440.0 Hz).

## ■ Instrument selection and settings for each part

Here you can select the instrument that will be used by each part, and make settings for Ambience, Key Shift (pitch adjustment in semitone steps) and Bend Range.

### Procedure

1. Press [PART]-[F1 (INST)].  
The “PART INST” page will appear.
2. Press [F1]–[F3] to select the part that you wish to set. The [F1]–[F3] buttons select Part 1, Part 2, and the Bass part respectively.
3. Use [CURSOR] to move the cursor to the parameter that you wish to set.
4. Use [INC/DEC] or the VALUE dial to make the setting.

### Parameters

Inst: 1–54

Select the instrument that you wish to use.

Ambience: 0–127

Adjust the amount of ambience.

Keyshift: -24–0–+24

Specify a pitch change in semitone steps.

Bend Range: 0–+24

Specify the maximum pitch change (in semitone steps) that will occur when pitch bend messages are received.

## ■ Mixer settings for each part

### Procedure

1. Press [PART]-[F2 (MIXER)].  
The mixer setting page will appear.
2. Press [F1]-[F4] to select the parameter that you wish to set.
3. Use [CURSOR] to move the cursor to the part that you wish to set.
4. Use [INC/DEC] or the VALUE dial to make the setting.

### Parameters

VOLUME ([F1]): 0–127

Adjusts the volume.

PAN ([F2]): L15–CENTER–R15

Adjusts the left/right(pan) position of the sound. “L15” is far left, “C” is center, “R15” is far right.

*\* If you have chosen headphones (Phones Only) as the output destination, the sound will be located in the center regardless of this setting.*

FXSEND ([F3]): 0–127

Adjusts the effect send level.

OUTPUT ([F4]): MASTER, PHONES

Select the output destination of the sound. The sound cannot be output from the DIRECT 1, 2, 3 outputs.

MASTER: Output from the MASTER OUT and PHONES jacks

PHONES: Output only from the PHONES jacks

## ■ Muting a specific part

### Procedure

1. Press [PART]-[F4 (MUTE)].  
The “PART MUTE” page will appear.
2. Press [F1]-[F4] to turn muting on/off.  
The [F1]-[F4] buttons correspond to Part 1, Part 2, Bass part, and the Drum part. Muting will be switched on/off each time you press the button.

# Chapter 7. Settings for the entire TD-10

## Changing output assignment for audio received by the MIX IN jack

Selecting the output destination of the sound input from the MIX IN jack.

### Procedure

1. Press [SETUP]-[F3 (CTRL)]-[F4 (OPTION)].  
The "OPTION" page will appear.
2. Use [CURSOR] to move the cursor to "Mix In Output."
3. Use [INC/DEC] or the VALUE dial to make the setting.

### Parameters

Monitor Mix In: Master, Phones Only

Master: Output from the MASTER output and the PHONES jack.

Phones Only: Output only from the PHONES jack.

## Specifying the type of pad

So that the TD-10 will be able to accurately receive the signals from the pads or pedals, use the following settings to specify the type of pads that you are using. In addition to the content covered in "Specify the pads that the TD-10 will use" (p. 29) of the "Quick Start," the section below will discuss Trigger Banks, and how to use acoustic drums with triggers or pads made by other manufacturers.

Press [SETUP]-[F1 (TRIG)]-[F1 (BANK)], and the following setting page will appear.



### What is the Trigger Type?

So that optimal settings can be made for each pad being used, you need to specify the type of pads being used. Indications such as "3 PD7" in the above display correspond to this. This indication means "a PD-7 pad is being used for TRIGGER INPUT number 3."

### What is a Trigger Bank?

Trigger Banks allow you to store the 12 trigger settings as a single unit of information. The large number at the left edge of the above display is the Trigger Bank number. Move the cursor to this area to select the Trigger Bank.

### Procedure

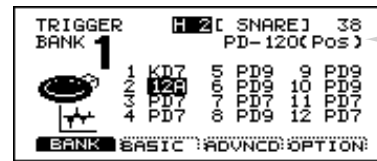

1. Press [SETUP]-[F1 (TRIG)]-[F1 (BANK)].  
The "TRIGGER" page will appear.
2. Use [CURSOR] to move the cursor to a location other than "BANK."
3. Strike the pad for which you wish to set the Trigger Type.  
The cursor will move to the trigger number of the pad that you hit.
4. Use [INC/DEC] or the VALUE dial to make the setting.  
Refer to the following table, and specify the type of pad.

Display	Model used
PD5	PD-5
PD7	PD-7
PD9	PD-9
12A	PD-120 (Strike location is detected)
12B	PD-120 (Strike location is not detected)
10A	PD-100 (Strike location is detected)
10B	PD-100 (Strike location is not detected)
KD7	KD-7/KD-5
P1, P2	When using a pad made by another manufacturer
K1, K2	When using a kick pad made by another manufacturer

\* If you want the tone to be affected by the strike location on a PD-100/120, select 10A/12A. The 10B/12B does not detect the strike location, but more rapid trigger response can be achieved.

\* If you wish to make even more detailed settings, refer to the explanation in the following section "Basic settings for the trigger parameters (BASIC)." Normally you don't need to adjust these parameters, but you may use them if you wish to make more accurate settings for your playing style.

\* Use the KIK, SNR, TOM, and FLR settings when you use acoustic drums to sound the TD-10. For details refer to p.142.

\* When using a pad made by another manufacturer, first select "PD7" and try playing the pad. If, with this setting, the pad striking force does not produce a stable volume, try a setting of "P1." A setting of "P2" will be even more stable, but since the Scan Time (p.111) will be even longer, the interval from when the pad is struck until the sound is heard will be slightly (approximately 0.003 seconds) longer.

(For a kick, select "KD7," and if the result is not stable, try "K1" or "K2.")

## Basic settings for the trigger parameters (BASIC)

When you are using pads made by other manufacturers, try adjusting the following parameters.

### ● Sensitivity

Adjust the sensitivity of the pad to regulate the pad response.

#### Procedure

1. Press [SETUP]-[F1 (TRIG)]-[F2 (BASIC)].  
The “TRIGGER BASIC” page will appear.
2. Use [CURSOR] to move the cursor to “Sensitivity.”
3. Strike the pad for which you wish to make settings.  
The setting display for the pad you struck will appear, and an input indicator will move in the lower part of the screen.
4. Use [INC/DEC] or the VALUE dial to make the setting.  
Adjust the Sensitivity value so that the strongest strikes cause the input indicator to reach nearly all the way to the maximum level (far right). Increasing this value will raise the sensitivity.

#### Parameters

Sensitivity: 1–16

### ● Threshold

This setting allows a trigger signal to be received only when the pad is struck harder than a specified force. This helps prevent unintentional triggering caused by vibrations that reach a pad when an adjacent pad is hit. In the following example, signal 2 will sound, but signals 1 and 3 will not sound.

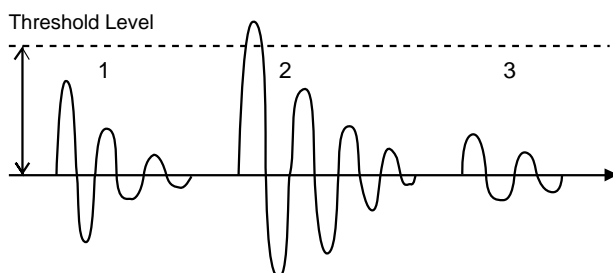

#### Procedure

1. Press [SETUP]-[F1 (TRIG)]-[F2 (BASIC)].  
The “TRIGGER BASIC” page will appear.
2. Use [CURSOR] to move the cursor to “Threshold.”
3. Strike the pad for which you wish to make settings.  
The setting page for the pad you struck will appear, and an input indicator will move in the lower part of the screen.

4. Use [INC/DEC] or the VALUE dial to make the setting.  
Gradually raise the Threshold value until the kind of unintentional triggering shown above no longer occurs. However if this value is raised too far, playing softly on the pad will not be detected. Check this and adjust accordingly. Repeat this process until you get the perfect setting for your playing style.

#### Parameters

Threshold: 0–15

### ● Curve

This is another fine adjustment of sensitivity other than the Trigger Sensitivity parameter, controlling the relation between the velocity (striking force) and changes in volume (the dynamic curve). Adjust this curve until the response feels as natural as possible.

#### Procedure

1. Press [SETUP]-[F1 (TRIG)]-[F2 (BASIC)].  
The “TRIGGER BASIC” page will appear.
2. Use [CURSOR] to move the cursor to “Curve.”
3. Strike the pad for which you wish to make settings.  
The setting page for the pad you struck will appear, and the input indicator will move.
4. Use [INC/DEC] or the VALUE dial to make the setting.

#### Parameters

Curve: Linear, EXP1, EXP2, LOG1, LOG2, Spline, Loud1, Loud2

Linear: This is the normal setting when using a PD-7, PD-9, PD-100 or PD-120, and produces the most natural correspondence between velocity and volume change.

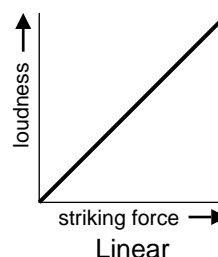

EXP1, EXP2: Compared to Linear, a wider volume change will occur for stronger hits.

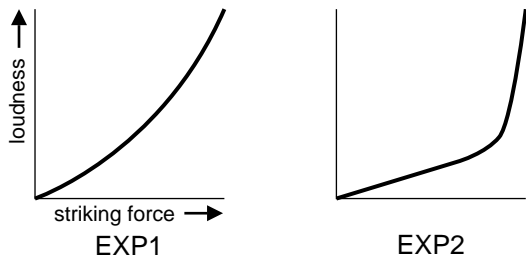

LOG1, LOG2: Compared to Linear, wider volume change will occur for softer hits.

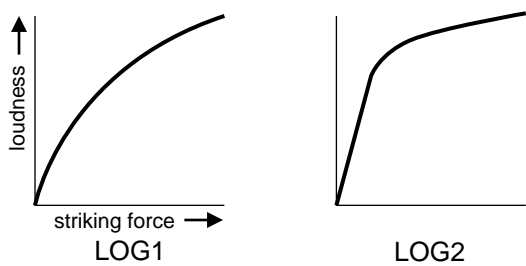

Spline: Variation in striking force will produce extreme change.

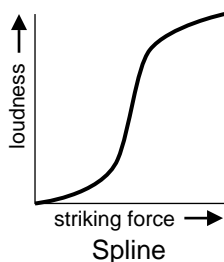

Loud1, Loud2: Variation in striking force will produce little change, and a constant volume will be maintained. When using drum triggers, these settings help maintain stable levels.

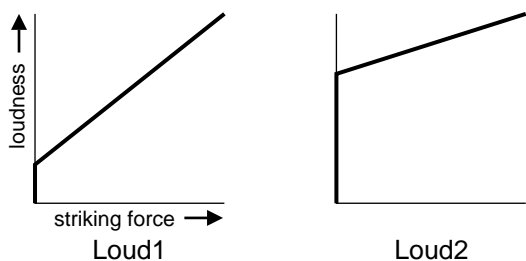

## ● Head Tension Adjustment

The Head Tension Adjustment parameter regulates the following two adjustments for the PD-100 and PD-120. Press [SETUP]-[F1 (TRIG)]-[F4 (OPTION)] and the setting page will appear.

\* The setting page for this setting will appear only if the Trigger Type (p. 108) is set to "10A" or "12A" for trigger number 2 (SNARE) and trigger number 10 (RIDE).

### Adjust the head to an even tension

This setting allows the strike location to be accurately detected. For the procedure refer to p. 31.

### Adjust the tension of the head

Adjusting the Head Tension Adjustment value to the standard value of "Normal" will provide an average head tension. If you wish to loosen this, select "Loose." To tighten it, select "Tight." Then refer to the procedure of p. 32. and adjust the tension.

\* Unlike tuning an acoustic drum, this setting will not affect the pitch. It affects only the tension of the head. But this is VERY important to achieve the best results for positional sensing, and to make sure that the head tension is even. For tuning the pitch of the sound, refer to p. 82.

### Parameters

Head Tension Adjustment: Loose, Normal, Tight

## ● Rim Sensitivity

When a PD-120 is used with trigger number 2 (SNARE), you can adjust the sensitivity of the rim. Higher settings will increase the sensitivity of the rim. With a setting of Off, only the head will sound.

### Procedure

1. Set the trigger type to "12A."  
For this setting, refer to p. 108.
2. Press [SETUP]-[F1 (TRIG)]-[F4 (OPTION)].  
The "TRIGGER OPTION" page will appear.
3. Use [CURSOR] to move the cursor to "Rim Sensitivity."
4. Use [INC/DEC] or the VALUE dial to make the setting.

### Parameters

Rim Sensitivity: Off, 1-15

\* Increasing the value excessively may cause the rim instrument to sound as well when the head is struck.

## Detailed settings for the trigger parameters (ADVNCDD)

The following parameters (ADVANCED EDIT) are automatically set to the most efficient values for each pad when you select the Trigger Type (p. 108), and don't require adjustment, except if you experience any of the problems that are discussed in the explanation of each parameter. Press [SETUP]-[F1 (TRIG)]-[F3 (ADVNCDD)] and the setting page will appear.

### ● Scan Time

Since the rise time of the trigger signal waveform may differ slightly depending on the characteristics of each pad or drum trigger (drum pickup) (TSC-10: optional), you may notice that identical hits (velocity) may produce sound at different volumes. If this occurs, you can adjust the Scan Time so that your velocity of playing can be detected more precisely.

#### Procedure

1. Press [SETUP]-[F1 (TRIG)]-[F3 (ADVNCDD)]. The "TRIGGER ADVANCED" page will appear.
2. Use [CURSOR] to move the cursor to "Scan Time."
3. Hit the pad for which you wish to make settings. The setting page for the pad you struck will appear.
4. Use [INC/DEC] or the VALUE dial to make the setting. While repeatedly hitting the pad at a constant force, gradually raise the Scan Time value from 0.0 msec, until the resulting volume stabilizes at the loudest level. At this setting, try both soft and loud strikes, and make sure that the volume changes appropriately. If the Scan Time setting is excessively high, there will be a longer delay until the note is heard, so set this to as low a value as possible.

#### Parameters

Scan Time: 0–4.0ms (0.1ms steps)

\* The "SCAN TIME" setting is automatically set to the most efficient values for each pad when you select the "TRIGGER TYPE" (p. 108). If you have lowered the "SCAN TIME", the head tension adjustment (p.110) does not work correctly.

### ● Retrigger Cancel (RetrigCancel)

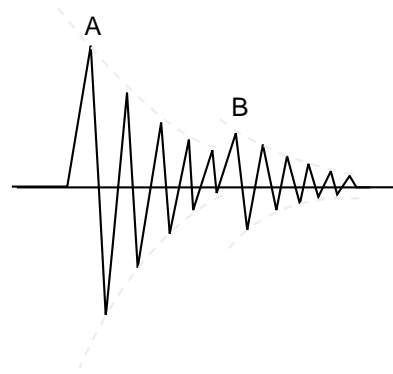

Sometimes in the case of a snare drum or other drum to which an acoustic drum trigger is attached, sound will occur at point "A" (as desired) but will also occur again at point "B" (undesired) due to distortions in the waveform. This is called "retriggering," and occurs in particular at the decay edge of the waveform. Retrigger Cancel detects such distortion in and prevents retriggering from occurring.

#### Procedure

1. Press [SETUP]-[F1 (TRIG)]-[F3 (ADVNCDD)]. The "TRIGGER ADVANCED" page will appear.
2. Use [CURSOR] to move the cursor to "RetrigCancel."
3. Hit the pad (or acoustic drum if using triggers) for which you wish to make settings and the setting page for the pad you struck will appear.
4. Use [INC/DEC] or the VALUE dial to adjust the setting. While repeatedly striking the drum, raise the RetrigCancel value until retriggering no longer occurs. Raising this value will strengthen retrigger canceling, but will also mean that notes may be lost during fast playing (a drum roll for example) Set this to as low a value as possible.

#### Parameters

RetrigCancel: 1–16

### ● Mask Time (MaskTime)

On a kick pad, for example, if the beater bounces back and strikes the pad a second time immediately after the intended stroke - (or, like with acoustic drums if you leave the bass drum beater against the head) this can cause a single strike to “double trigger”. (two sounds instead of the intended “one”) The Mask Time setting helps to prevent such problems. Once a pad has been hit, any additional trigger signals occurring within the specified MaskTime (0–64 msec) will be ignored.

\* *Playing electronic bass drum triggers requires that you realize this-as “laying into the head,” as you might do with a real bass drum, will not work here, and can cause this double triggering problem. This occurs most often with the bass drum trigger. With other pads, it only occurs if you leave the stick pressing against the head immediately after hitting it. Though technology today can perform many miracles, you still have to play with good technique.*

#### Procedure

1. Press [SETUP]-[F1 (TRIG)]-[F3 (ADVNC)].  
The “TRIGGER ADVANCED” page will appear.
2. Use [CURSOR] to move the cursor to “MaskTime.”
3. Hit (or kick) a pad for which you wish to make settings and the setting page for that pad appears.
4. Use [INC/DEC] or the VALUE dial to make the setting.  
While playing the kick pad, try kicking and leaving the beater against the pad. If you hear the second note being triggered, raise the MaskTime. But in doing so, it also means that if you play very fast, certain notes may be lost. It may be easier for you to understand how mask time works by using a snare or tom pad, and playing a single handed “buzz” stroke. Raise the mask time to see how it affects this technique.

\* *Never forget that your own playing technique has a lot to do with these potential problems.*

#### Parameters

MaskTime: 0–64 ms (4 ms steps)

### ● Crosstalk

When two pads are mounted on the same stand, the vibration produced by hitting one pad may trigger the sound from another pad unintentionally. (This is called crosstalk.) The Crosstalk setting lets you prevent such problems. Normally this won't happen if the pads are not too close to each other and mounted on a solid stand. Playing technique is also an influence.

#### Procedure

1. Press [SETUP]-[F1 (TRIG)]-[F3 (ADVNC)].  
The “TRIGGER ADVANCED” page will appear.

2. Use [CURSOR] to move the cursor to “Crosstalk.”
3. Hit the pad for which you wish to make settings and the setting page for the pad you struck will appear.
4. Use [INC/DEC] or the VALUE dial to adjust the setting.  
If for example, if when hitting a tom pad, the ride cymbal also sounds, then raise the Crosstalk setting for the ride cymbal pad from “Off” through “30”, “40” ... until crosstalk no longer occurs. As this value is raised, the ride cymbal pad will be less prone to receive crosstalk from other pads. Increasing the Crosstalk value may cause a different problem when playing two pads simultaneously, as the pad receiving the weaker hit may fail to respond. So be careful and set this parameter to the minimum value required to prevent such crosstalk. With a setting of “Off,” crosstalk prevention does no function.

#### Parameters

Cross Talk: OFF, 30, 40, 50, 60, 70, 80

## The order in which trigger parameters should be set when using drum triggers

If you are using drum triggers, make settings following the sequence given below to ensure the best results. For details on each parameter, refer to p. 109–112.

#### Procedure

1. Refer to the explanation on p. 108 and select the Trigger Type.
2. Set the Threshold and Curve parameters to “normal” values.  
Press [SETUP]-[F1 (TRIG)]-[F2 (BASIC)] to access the setting page. Use [CURSOR] to move the cursor to the parameters, and use [INC/DEC] or the VALUE dial to make the following settings.  
Threshold: 0  
Curve: Linear
3. Sensitivity  
In the setting page of step 2, use [CURSOR] to move the cursor to “Sensitivity.” Make settings so that the input indicator in the left part of the display reaches the maximum level when the pad is struck strongly.  
The settings below can be made in the setting page accessed by pressing [SETUP]-[F1 (TRIG)]-[F3 (ADVNC)].
4. Scan Time  
Strike the head several times with the same force, and adjust this parameter if the volume is uneven.
5. Retrigger Cancel (RetrigCancel)  
This prevents multiple notes from sounding when a drum is struck once (mainly for a snare drum or toms).



**6. Mask Time**

Mainly for bass drums so please refer to the explanation above.

**7. Crosstalk**

Same principle as with using pads as explained above. Once again, press [SETUP]-[F1 (TRIG)]-[F2 (BASIC)] and the setting page will appear.

**8. Threshold**

If notes are unintentionally sounded even after you have adjusted the Crosstalk setting, adjust the Threshold. If this parameter is raised excessively, playing softly may NOT trigger the TD-10, so keep the value as low as possible.

**9. Curve**

If changes in playing dynamics do not produce a natural change in the volume of the TD-10 instrument, adjust this parameter.

## Adjusting the brightness of the display

The display contrast is strongly influenced by the location of the TD-10 and the lighting of the room it's in. Adjust this parameter when needed.

**Procedure**

1. Press [SETUP]-[F3 (CTRL)]-[F3 (DISPLY)].  
The "DISPLAY CONTRAST" page will appear.
  2. Use [INC/DEC] or the VALUE dial to make the setting.
- \* OR You can do this by holding down [KIT] and rotating the VALUE dial.

## Setting the master equalizer

The master equalizer allows balancing the high, mid, and low frequencies.

\* This equalizer is not applied to the sound which is output from the DIRECT 1, 2, 3 jacks.

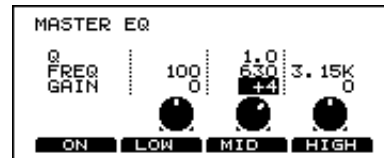
**Procedure**

1. Press [KIT]-[F4 (MAS EQ)].  
The "MASTER EQ" page will appear.
2. Use [CURSOR] to move the cursor to the frequency you wish to adjust.
3. Use [INC/DEC] or the VALUE dial to make the setting.  
In this page, [F1] will switch the equalizer on/off. Pressing [F2][F3][F4] will move the cursor directly to the low (LOW), mid (MID), and high (HIGH) settings respectively.

**Parameters**

The following parameters can be set for each of the three points (low, mid, high).

GAIN: -15-0-+15

Specify the amount of boost/cut. Negative (-) settings will produce a cut.

FREQ (Frequency): 20-500 (Low), 100-4k (Mid),  
500-20k (High)

Select the frequency you wish to boost or cut.

The following parameter can be set only for the mid range.

Q: 0.5, 1.0-20 (1.0 steps)

Adjust the width of the frequency range. Depending on the "Q" value, raising the "GAIN" may boost both the low and high ranges.

## Saving data to a memory card

An optional memory card (M-512E) can be used to save TD-10 settings and sequencer data.

\* *The Roland M-512E is the ONLY memory card which can be used.*

### ● About the Protect switch

When the protect switch of the M-512E is turned on, it will not be possible to write data from the TD-10 to the memory card. Normally you should leave the protect switch turned on, and turn it off only when you wish to write data into the card.

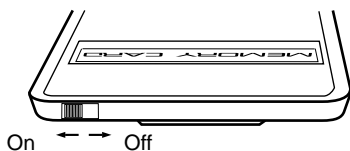

### ● When using a card for the first time

When a card is being used for the first time, or if the card has been used by another device, you must execute the following procedure to initialize the card. (This prepares the card for use with the TD-10.)

\* *When a card is initialized, all data on that card will be lost. Make sure that it does not contain data you wish to keep for another device.*

1. Press [KIT].

The "DRUM KIT" page will appear.

2. Set the protect switch located at the top of the memory card to the "Off" position.

3. Insert the memory card into the MEMORY CARD slot located on the rear panel.

The "INITIALIZE CARD" page will appear.

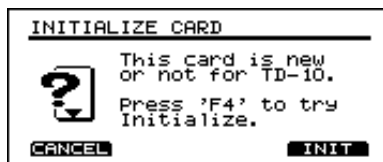

4. Press [F4 (INIT)].

A confirmation display will appear.

5. Press [F4 (EXEC)] and the memory card will be initialized. (Press [F1 (CANCEL)] to return to the previous page without carrying out the operation.)

## ■ Saving data to a memory card

All data (drum kits, patterns, percussion group, and setup) will be saved.

### Procedure

1. Press [SETUP]-[F4 (UTIL)]-[F1 (SAVE)].

The "Save to CARD" page will appear.

2. Move the protect switch on the memory card to the "OFF" position.

3. Insert the memory card into the MEMORY CARD slot located on the rear panel.

\* *If you insert a card being used for the first time or a card that has been used by another device, the "INITIALIZE CARD" page will appear. Refer to "When using a card for the first time" and initialize it.*

4. Press [F4 (SAVE)].

A confirmation display will appear.

5. Press [F4 (EXEC)] and the data will be saved to the memory card. (Press [F1 (CANCEL)] to return to the previous page without executing the operation.)

\* *You can also save individual kits to a memory card. To do so, use the Copy function (p. 117).*

## Loading data from a memory card

Data saved on a memory card can be loaded into the TD-10.

### Procedure

1. Press [SETUP]-[F4 (UTIL)]-[F2 (LOAD)].  
The "LOAD from CARD" page will appear.
2. Insert the memory card into the MEMORY CARD slot.
3. Press [F4 (LOAD)].  
A confirmation display will appear.
4. Press [F4 (EXEC)] and the data will be loaded from the memory card. (Press [F1 (CANCEL)] to return to the previous page without executing the operation.)

\* *You can also load individual kits from a memory card. To do so, use the Copy function (p. 117).*

## Automatically switching the display (Note Chase)

When editing sounds, the TD-10's display will switch corresponding to the sound that is used when a pad is hit (or when a MIDI message is received). This function is called Note Chase.

Note Chase will always be ON for notes that are struck on a pad. This function can be turned off for notes received from MIDI IN.

### Procedure

1. Press [SETUP]-[F2 (MIDI)]-[F1 (GLOBAL)].  
The "MIDI GLOBAL" page will appear.
  2. Use [CURSOR] to move the cursor to "Note Chase."
  3. Use [INC/DEC] or the VALUE dial to turn the setting on/off.
- \* *Note Chase will NOT function while the INTERNAL sequencer is playing.*

# Chapter 8. Convenient functions

## Selecting kits in the desired order (Drum Kit Chain)

### ■ Specifying a Drum Kit Chain

This allows you to step through the drum kits of your choice and in the order you want. (via the INC/DEC buttons or footswitch operation). TD-10 lets you create and store 16 different chains of up to 32 steps each.

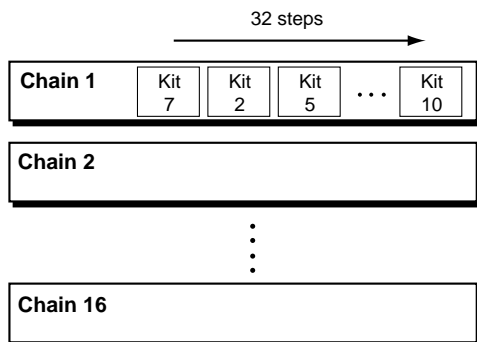

#### Procedure

1. Press [CHAIN]-[F1 (C EDIT)].  
The "CHAIN EDIT" page will appear.
2. Use [CURSOR] to move the cursor to the large number (the chain number) in the left of the display.
3. Use [INC/DEC] or the VALUE dial to select the chain number you wish to work on.
4. Use [CURSOR] to move the cursor to the "step" number within the selection sequence, shown at the right of the page.
5. Use [INC/DEC] or the VALUE dial to select the drum kits in the order in which you wish to play them.

#### Function buttons

- [F1 (INSERT)]: Inserts the kit after the cursor location, moving the subsequent items of the chain one step toward the end.
- [F2 (DELETE)]: Deletes the kit at the cursor location, moving the subsequent items of the chain one step toward the beginning.
- [F3 (NEXT)]: Advances to the next step.
- [F4 (NAME)]: Assigns a name to the chain. For details see the following section.

#### How to use the CHAIN

1. Press [CHAIN] to make the button indicator light. The Drum Kit Chain function will be turned on.
  2. Use the left/right [CURSOR] or [INC/DEC] to select kits in the order that you specified in the chain. You can use the up/down [CURSOR] to select chains.
- \* Press [CHAIN] to make the indicator go dark and the Drum Kit Chain function will be turned off.

#### Applications

When this function is used together with the Pad Switch function or the Foot Switch function, you can use a pad or foot switch to select drum kits in a drum kit chain. To do this, set the MODE setting of the Pad Switch function or Foot Switch function to "KIT SELECT." For details refer to "Operations using pads and foot switches" (p. 119).

### ■ Naming a Drum Kit Chain

You can assign a name of up to 8 characters to each chain.



#### Procedure

1. Press [CHAIN]-[F1 (C EDIT)]-[F4 (NAME)].  
The "CHAIN NAME" page will appear.
2. Use the left/right [CURSOR] to move the cursor to the character that you wish to change.  
The blinking character is the one that can be changed.
3. Use either the VALUE dial, [INC/DEC], or [CURSOR] to change the character. Characters can be selected in the order shown in the bottom of the screen.

#### Function buttons

- In this page, the [F1]-[F4] buttons perform convenient functions for entering characters.
- [F1 (INSERT)]: All characters to the right of the cursor will be moved to the right.
- [F2 (DELETE)]: The character at the cursor location will be deleted, and all characters to the right of the cursor will be moved to the left.
- [F3 (SPACE)]: A blank space will be inserted at the cursor location.
- [F4 (CHAR)]: Cycle between uppercase/lowercase/symbols.

## Copying

You can copy drum kits, instruments, mixer & effect settings etc. to the destination of your choice. However, doing so will erase (overwrite) the data that was in the new destination. So be careful before you perform this operation.

\* *Some display pages do not allow copy. In such cases, pressing [TOOLS] will not produce "COPY" above [F1] in the display.*

### Procedure

(Example) Copying a kit

Select the copy source.

1. Press [KIT].

The "DRUM KIT" page will appear.

2. Press [TOOLS].

The function names for [F1]–[F4] appear in the lower part of the display.

3. Press [F1 (COPY)].

The display ("COPY DRUM KIT") shows the source and destination position. Use the [INC/DEC] or the VALUE dial to select the source and destination.

\* *[PRESET] refers to the drum kits that were stored in the unit at the factory. [USER] refers to drum kits that currently can be used. And, [CARD] refers to drum kits stored on memory card.*

4. Press [F4 (COPY)].

A confirmation display will appear.

5. Then press [F4 (EXEC)] and the kit will then be copied (Press [F1 (CANCEL)] to return to the previous page without executing out the operation.)

\* *If you press [F3 (EXCHNG)], the contents of the new destination and copy source will be exchanged, a convenient way to rearrange or organize drum kits.*

### A display in which Copy can be used

"DRUM KIT" page ([KIT])

"INST" page ([INST])

Instrument Copy will be done only to the same TRIGGER INPUT jack of the other kit.

"STUDIO" page ([STUDIO])

"CONTROL ROOM" page ([CONTROL ROOM])

"TRIGGER BANK" page ([SETUP]-[F1 (TRIG)]-[F1 (BANK)])

"PERC GROUP" page ([KIT]-[F2 (FUNC)]-[F1 (PRCGRP)])

"MIXER" page ([CONTROL ROOM]-[F1 (MIXER)])

"COMPRESSOR/LIMITER" page ([CONTROL ROOM]-[F2 (COMP)])

Compressor settings can be copied to another kit for TRIGGER INPUT jacks 1–10 as a group.

"EQ" page ([CONTROL ROOM]-[F3 (EQ)])

Equalizer settings can be copied to another kit for TRIGGER INPUT jacks 1–10 as a group.

"EFFECT" page ([CONTROL ROOM]-[F1 (EFFECT)])

## The UNDO function

The UNDO function allows you to recall original parameters of any function you have edited, but ONLY from the "present" cursor position. If you change the cursor position, or page in the display, UNDO will not work.

Example: If when choosing an instrument, you scroll through many sounds not finding the one you want. "UNDO" can bring back the "original" setting. Only changes made with the [INC/DEC] buttons or the VALUE dial can be "undone." And ONLY in Pages where pressing [TOOLS] calls up [F3(UNDO)] in the display.

### Procedure

(Example: Undoing an instrument selection)

1. Press [INST].

The "INST" page will appear.

2. Use [INC/DEC] or the VALUE dial to select a different instrument.

If you want to bring back the original instrument just execute UNDO.

3. Press [TOOLS].

The function names for [F1]–[F4] will appear in the lower part of the display.

4. Press [F3 (UNDO)].

The instrument that had been selected in step 1 will reappear.

\* *If while editing, you accidentally touch another pad or rim, you cannot "undo" the parameter you were working on. Also, Bulk Load, Kit Copy/Exchange cannot be "undone."*

## Getting help

---

The TD-10 comes with a built in “help page” using keywords to select various functions, and a “jump” mode to take you to that setting page instantly.

### Procedure

1. Press [TOOL]-[F4 (HELP)].  
A list of help keywords (“HELP INDEX”) will appear.
2. Use [F1 (UP)] or [F2 (DOWN)] to select a keyword.
3. Press [F4 (SELECT)].
4. If you wish to jump to the setting page for the displayed function, press [F4 (GO NOW)]. To return to the keyword select page, press [F1 (INDEX)].

## Specifying how the Preview button functions

---

To audition and edit instruments, tap [PREVIEW]. Press [TRIG SELECT] in the “INST” page to select the trigger input number corresponding to the pad/sound you wish to listen to. The trigger number and instrument will appear in the upper right of the display. The [RIM] indicator will show whether the head or the rim is selected. Or call up a sound in the percussion group.

You have various choices of how the [PREVIEW] button will respond.

### Procedure

1. Press [SETUP]-[F3 (CTRL)]-[F4 (OPTION)].  
The “PREVIEW SETTINGS” page will appear.
2. Use [CURSOR] to move the cursor to “Preview Button.”
3. Use [INC/DEC] or the VALUE dial to make the setting.  
ON: The volume will be fixed, regardless of the force of your tap.  
OFF: The strength of your tap will affect the volume.
4. With a setting of “OFF,” you can specify the volume. Use [CURSOR] to move the cursor to “Velocity.”
5. Use [INC/DEC] or the VALUE dial to specify the volume.  
With a setting of “1” will produce the minimum volume. A setting of “127” will produce the maximum volume.

# Chapter 9. Operations using pads and foot switches

By changing the function of controllers or the way in which they are used, you can perform a variety of convenient operations. This opens up some very interesting performance possibilities.

## Using pads to play patterns (Pad Pattern) **HEAD RIM**

You can make settings so that striking a pad will playback a previously selected pattern. This function provides a very convenient way to use patterns during a live performance.

\* If different patterns have been assigned to two or more pads, striking another pad while a pattern is playing back will cause pattern playback to switch to the newly selected pattern. If you have switched to a pattern whose instrument settings are different, the sound may be interrupted for an instant.

### Procedure

1. Press [INST]-[F4 (CTRL >)]-[F3 (PATTERN)].

The "INST CTRL" page will appear.

2. Strike the pad that you wish to edit.

The setting page for the pad you struck will appear.

3. Use [INC/DEC] or the VALUE dial to select the pattern number.

With a setting of "OFF," the Pad Pattern function will be off.

\* The symbol on the right side of the pattern name indicates how the pattern will be played back. For details on this setting, refer to p. 98.

4. The pattern will playback when you hit the pad.

\* If you do not want to hear the instrument assigned to that pad, press [CONTROL ROOM]-[F1 (MIXER)]-[F1 (VOLUME)] and set the volume to "0."

\* Pad patterns cannot be used during sequencer recording.

## Using pads to perform button operations (Pad Switch)

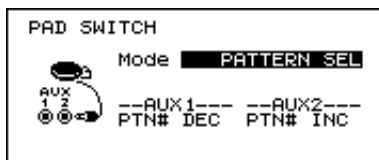

### Procedure

1. Connect pads to TRIGGER INPUT jacks AUX 1 and AUX 2.

2. Press [SETUP]-[F3 (CTRL)]-[F2 (PAD SW)].

The "PAD SWITCH" page will appear.

3. Use [INC/DEC] or the VALUE dial to select the combination of functions for the AUX 1 and AUX 2 jacks (refer to the following).

4. Press [EXIT] to exit this page.

5. Strike the selected pads, and they will function as switches.

### Parameters

Mode (function name)	Function of the pad connected to the AUX1 jack	Function of the pad connected to the AUX2 jack
OFF	Pad switch is off	Pad switch is off
KIT SELECT	Pad switch is off	Select the next kit
PATTERN SEL	Pad switch is off	Select the next pattern
KIT SELECT (2)	Select the previous kit	Select the next kit
PATTERN SEL (2)	Select the previous Pattern	Select the next pattern

- \* If you do not want to trigger instrument sounds assigned to the pads, press [CONTROL ROOM]-[F1 (MIXER)]-[F1 (VOLUME)], and set the volumes of AUX 1 and AUX 2 to "0."
- \* If the "Mode" setting is "KIT SELECT" or "PATTERN SEL," striking the rim of the pad will have the same function as pressing [DEC].
- \* If you wish to use Drum Kit Chain (p. 70) to select kits, set the above "MODE" parameter to "KIT SELECT," and press [CHAIN] to make the button indicator light. (Create your Drum Kit Chain settings first.)

## Using foot switches to perform button operations (Foot Switch)

Two foot switches (BOSS FS-5U, optional) and a special cable (PCS-31) can be used to operate the TD-10. Set "Mode" to specify the function of the two pedals.



Foot switch	SW1	SW2
FS-5U x 2 (PCS-31)	o (red)	o (white)
DP-2	-	o
	o: Function	-: Not function

### Procedure

1. Connect the foot switch to the FOOT SWITCH jack.
2. Press [SETUP]-[F3 (CTRL)]-[F1 (FOOTSW)].  
The "FOOT SWITCH" page will appear.
3. Use [INC/DEC] or the VALUE dial to select the combination of functions that the foot switch will perform (refer to the following table).
4. Press [EXIT] to exit this page.
5. Press the foot switches, and they will function as switches.

### Parameters

Mode (function name)	SW1	SW2
KIT SELECT	Select the previous kit	Select the next kit
PATTERN SEL	Select the previous pattern	Select the next pattern
PATTERN PLAY	Select the next pattern	Playback/stop the pattern

- \* To use foot switches to select kits using a Drum Kit Chain (p. 70), set the above "MODE" parameter to "KIT SELECT," and press [CHAIN] to make the button indicator light. (Create your Drum Kit Chain settings first.)



# Chapter 10. Functions using MIDI

There are many possibilities when using MIDI, such as:

## 1. Use an external sequencer to save/load drum kits, pattern data etc.

## 2. Use the pads to play external instruments

As the TD-10 is a pad-to-MIDI interface, using external modules, samplers etc. can expand your potential (p. 122).

## 3. When using an external sequencer, the TD-10 is a powerful drum sound module especially when accessing the Percussion group for an even wider variety of instruments (p. 126).

## Saving/Loading data to/from an external device (Bulk Dump)

### ■ Saving data

To save data, use the external sequencer as you would when recording musical data, and perform the following steps on the TD-10 as shown in the following diagram. Use a MIDI cable to connect the TD-10's MIDI OUT jack to the MIDI IN jack of the external sequencer.

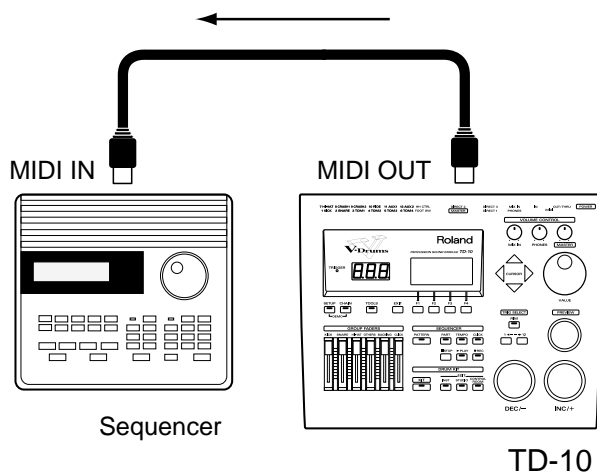

### Procedure

1. Press [SETUP]-[F2 (MIDI)]-[F4 (BULK)].  
The "BULK DUMP" page will appear.
2. Use [INC/DEC] or the VALUE dial to select the data that will be transmitted.

ALL: All data (drum kits, patterns, percussion groups, and setup) will be transmitted.

SETUP: Trigger and pad settings. will be transmitted.

ALL DRUM KITS: Drum kits 1-50 will be transmitted.

ALL PERC GROUP: Data for percussion groups 1-4 will be transmitted.

ALL PATTERN: Data for patterns 51-100 will be transmitted.

3. Press [F4 (EXEC)] and data transmission will begin.  
(Press [F1 (CANCEL)] to return to the previous page without carrying out the operation.)

\* Bulk dump is a type of system exclusive (SYSEX) data. Use an external MIDI sequencer and be sure that it can receive and record SYSEX data.

### ■ Loading saved data to the TD-10

As shown in the following diagram, use a MIDI cable to connect the TD-10's MIDI IN connector to the MIDI OUT connector of the external sequencer.

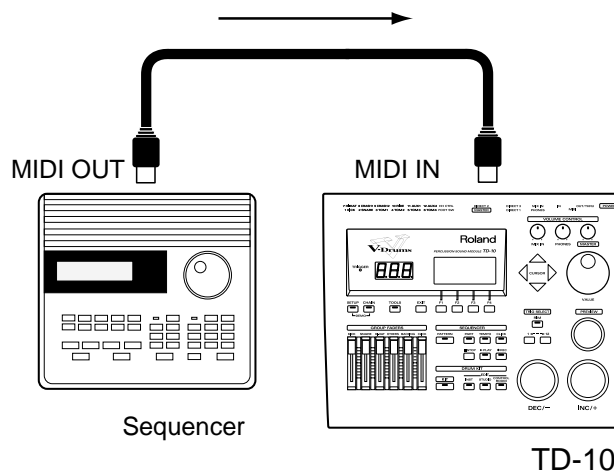

No special settings are required for the TD-10 to receive data from an external sequencer. Everything is done automatically.

\* When doing so, the data that was previously in the TD-10's memory will be lost. Be sure you have a backup!

## ■ Setting the Device ID —Transmitting saved data to two or more TD-10 units

The setting described here is necessary only when you wish to transmit separate data to two or more TD-10 units at the same time. Do not change this setting in any other case. If you lose track of the Device ID setting that was used when saving data via a bulk dump, it will no longer be possible to reload the bulk data that was saved.

\* With the factory settings, the device ID is set to 17.

### Procedure

1. Press [SETUP]-[F2 (MIDI)]-[F1 (GLOBAL)]. The "MIDI GLOBAL" page will appear.
2. Use [CURSOR] to move the cursor to "DEVICE ID."
3. Use [INC/DEC] or the VALUE dial to make the setting.

### Parameters

Device ID: 1–32

### Usage

(Example) Suppose that when data was saved via bulk dump, the TD-10's Device ID was set to "17." When re-transmitting this data back to the TD-10, it won't receive if the Device ID is set to something other than 17.

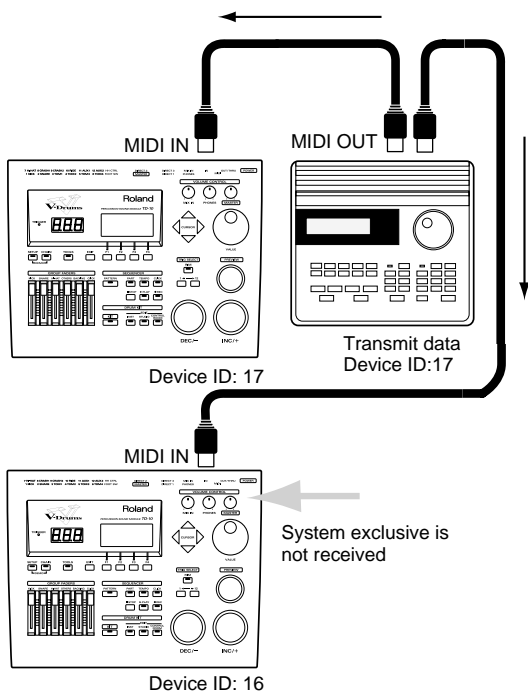

## Using pads to play an external MIDI sound module

Here's how to make settings.

\* You can play the TD-10 sounds with external sounds (called "layering")

As shown in the following diagram, use a MIDI cable to connect the TD-10's MIDI OUT to the MIDI IN connector of the external MIDI sound source.

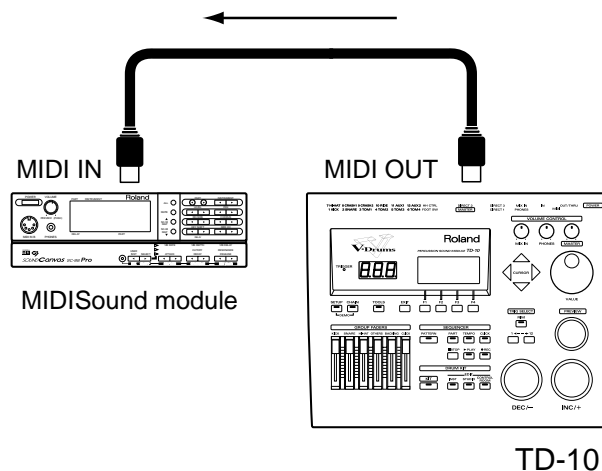

## ■ Selecting the note number transmitted by each pad **HEAD RIM**

You can select the MIDI note number (key number) that each pad will transmit. Set this to the note number of the sound that you wish to play on the external sound module or sampler.

### Procedure

1. Press [INST]-[F4 (CTRL)]-[F4 (MIDI)]. The "INST CTRL" page will appear.
2. Strike the pad that you wish to edit. The note that is assigned to the pad will be indicated on the keyboard in the screen. Also, the note number will appear in "Note No."
3. Use [CURSOR] to move the cursor to "Note No."
4. Use [INC/DEC] or the VALUE dial to select the note number.

### Parameters

Note No.: 0 (C -)–127 (G 8)

\* For the hi-hat, make the setting only for the note number for the Open Hi-hat (default setting is 46 (A#2)). This setting will adjust the closed and pedal sounds as well.

(Example) If you decrease the Open Hi-hat note number by "2," the Close and Pedal settings will also decrease by "2."

## ■ Setting the Gate Time

### HEAD RIM

For each pad, you can specify the length of time the note will "hold" during transmission from the MIDI OUT.

Drum sound modules normally produce sound only in response to "note-on" messages, and ignore "note-off" messages. However general-purpose sound modules or samplers do receive the note-off messages that are transmitted and respond by turning off the sound. For example, if you are triggering a "loop" in a sampler, or other sounds then the gate time parameter is very important. With the factory defaults (preset values), the transmitted gate time is set to the minimum value.

### Procedure

1. Press [INST]-[F4 (CTRL)]-[F4 (MIDI)].  
The "INST CTRL" page will appear.
2. Use [CURSOR] to move the cursor to "Gate Time." 3. Use [INC/DEC] or the VALUE dial to specify the duration of the notes.

### Parameters

Gate Time: 0.1–8.0 seconds

## ■ Setting the MIDI channel

For setting the MIDI channel, refer to the section below, "MIDI settings for the entire TD-10." Performance on the pads is transmitted from MIDI OUT on the same channel as the channel setting for the Drum part ("All Drums" in the setting page).

## Using the TD-10 with the Roland SPD-11

This section explains how you can use the Roland SPD-11 (a MIDI controller) together with the TD-10's pads to play internal sounds and an external sound Module. Connect the SPD-11 and TD-10 as shown below.

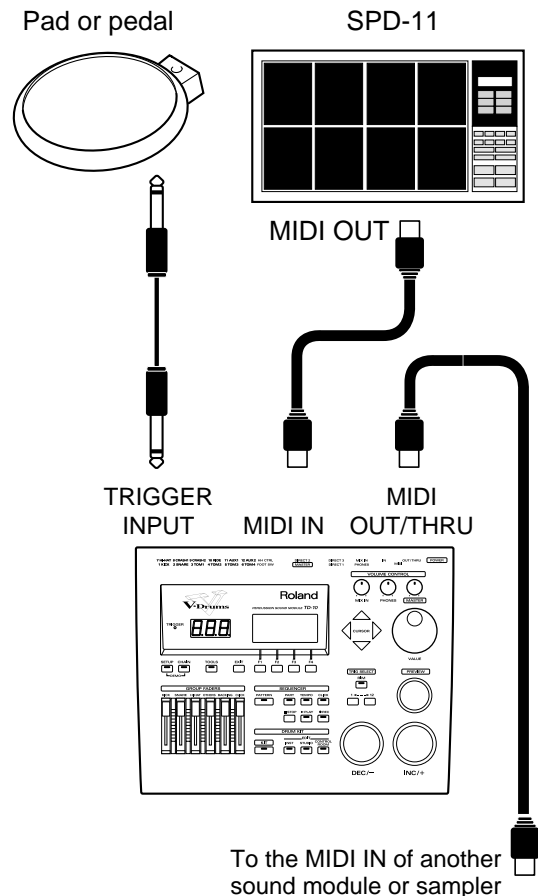

### Procedure

1. Press [SETUP]-[F2 (MIDI)]-[F1 (GLOBAL)].  
The "MIDI GLOBAL" page will appear.
2. Use [CURSOR] to move the cursor to "Soft Thru."
3. Use [INC/DEC] or the VALUE dial to turn the setting "ON."  
The messages (except for System Exclusive) received at MIDI IN will also be transmitted from the MIDI OUT/THRU connector.

\* If this setting is not used, leave it "OFF" as the trigger response of the pads will be faster.

### Parameters

Soft Thru: OFF, ON

## MIDI settings for the entire TD-10

### ■ Setting the MIDI channels for each Part

For each part, you can specify the channel on which the TD-10 will receive and transmit MIDI messages.

#### Procedure

1. Press [SETUP]-[F2 (MIDI)].  
The "MIDI" page will appear.
2. Use [CURSOR] to move the cursor to the part whose MIDI channel you wish to set.
3. Use [INC/DEC] or the VALUE dial to specify the channel number.

With a setting of "1" through "16," MIDI messages will be transmitted and received on that channel. A setting of "OFF" lets you turn off reception for that part, so that notes are not received.

#### Parameters

Channel: ch 1–ch 16, OFF

### ■ Turning off Local Control

This setting is required when you wish to record your pad performance on an external MIDI sequencer.

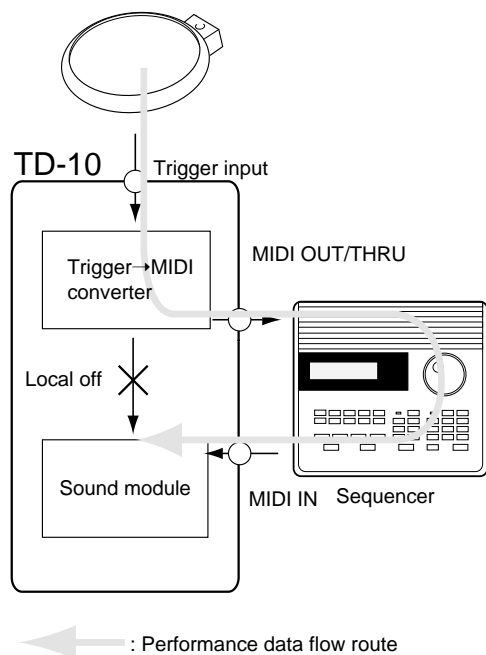

So that the performance data from the pads is NOT sent directly to the sound generating section of the TD-10 (Local Control off), but is instead sent first to the external sequencer via the MIDI OUT, and then re-transmitted to the TD-10, please refer to the above diagram.

#### Procedure

1. Press [SETUP]-[F2 (MIDI)]-[F1 (GLOBAL)].  
The "MIDI GLOBAL" page will appear.
2. Use [CURSOR] to move the cursor to "Local Control."
3. Use [INC/DEC] or the VALUE dial to turn the setting "OFF."

\* If you make connections and record as shown figure with a setting of Local On, duplicate notes will be re-transmitted to the TD-10 and will not be played correctly.

#### Parameters

Local Control: OFF, ON

### ■ Disabling reception or transmission of Program Changes

You can specify whether or not the TD-10 will transmit and/or receive program change messages to/from an external device.

#### Procedure

1. Press [SETUP]-[F2 (MIDI)]-[F3 (PROG)].  
The "MIDI Program Change" page will appear.
2. Each time you press [F1], reception will be turned on/off.  
Each time you press [F2], transmission will be turned on/off.

### ■ Reducing the amount of data transmitted by the FD-7 (Pedal Data Thin)

This function allows you to prevent an excessive amount of data from being transmitted from the pedal to the internal sequencer or via the MIDI OUT.

#### Procedure

1. Press [SETUP]-[F2 (MIDI)]-[F1 (GLOBAL)]. The "MIDI GLOBAL" page will appear.
2. Use [CURSOR] to move the cursor to "Pedal Data Thin."
3. Use [INC/DEC] or the VALUE dial to make the setting.  
With a setting of "1" or "2," pedal data will be thinned out. "2" will reduce the amount of data more drastically than "1." Normally you should use a setting of "1," and select "2" when you need greater data reduction. With a setting of "Normal" the data will not be thinned.

\* Leave this at the normal setting if you are being extremely precise with how you are using the FD-7 controller.

#### Parameters

Pedal Data Thin: OFF, 1, 2

## Using the TD-10 as a sound module

As shown in the following diagram, use a MIDI cable to connect the TD-10's MIDI IN to the MIDI OUT connector of an external sequencer, keyboard or pad controller (such as SPD-11).

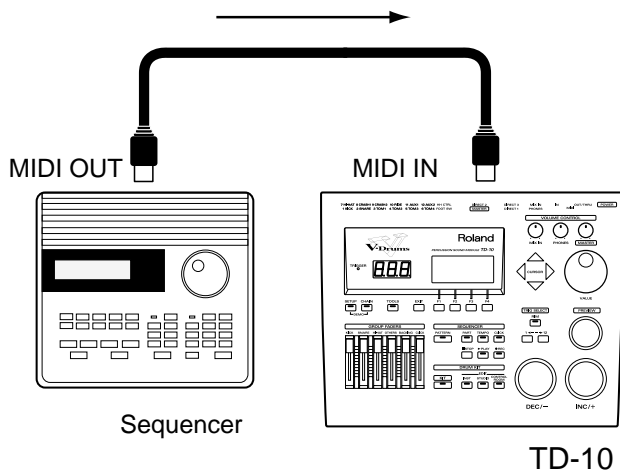

The settings discussed here are necessary only when using the TD-10 as a MIDI sound module.

\* When using the TD-10 as a 4-part sound module, the sounds you select must be assigned to a PATTERN as the pattern parameters store which sounds you are using. In this case it's best to use an empty pattern to make these settings. (Press [PATTERN]-[F4 (NEW)] to select an empty pattern containing no performance.)

### ■ Setting the instrument for each part

Refer to "Chapter 6. Sequencer" in the section "Settings for part instruments" (p. 106).

If you wish to select instruments for the backing parts (Part 1, Part 2, Bass part) from an external MIDI device, transmit program changes (PG) 1-54. These correspond to instruments 1-54 of the TD-10's backing parts.

### ■ Adjusting the mixer settings for each part

Refer to "Chapter 6. Sequencer" in the section "Settings for part instruments" (p. 106).

### ■ Regarding note numbers for the drum kit sounds

Refer to "Selecting the note number transmitted by each pad" (p. 122).

#### Example of settings for General MIDI score

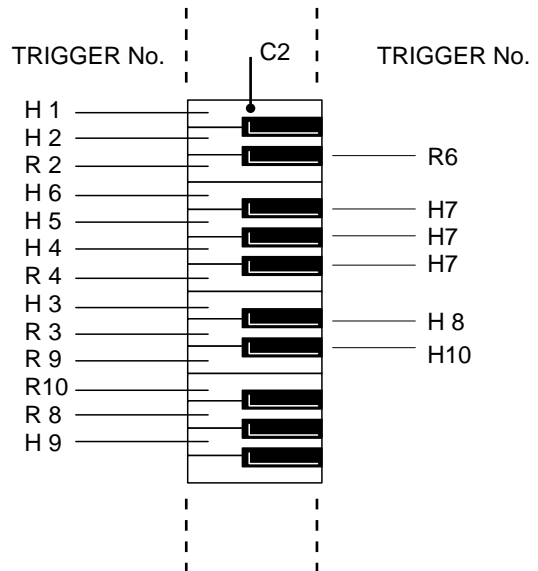

## ■ Using the percussion group

The percussion group is used only when playing the TD-10 from an external MIDI controller, keyboard or sequencer.

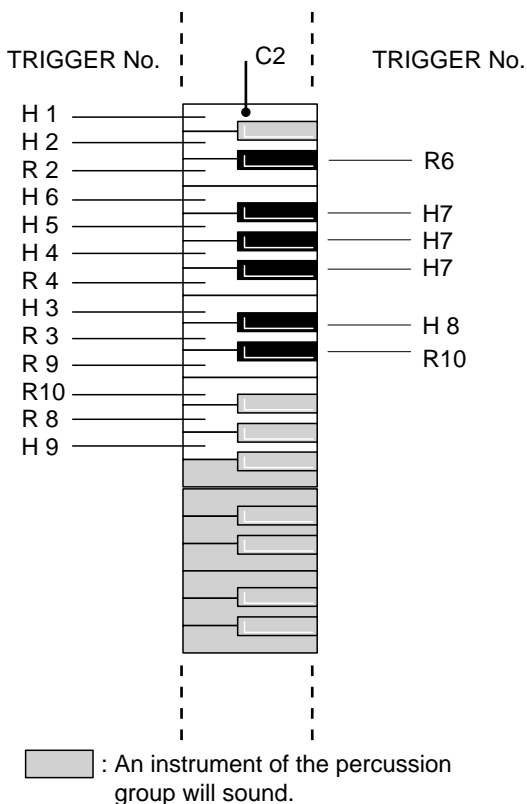

The sounds in the percussion groups have their own independent note number “map” in order to be played from an external MIDI controller, and can be changed if you want.

\* If the same note number is assigned to both a pad and an instrument in the percussion group, the pad has “priority” and you will only hear the sound assigned to that pad.

\* For details on note number assignments, refer to the table on p. 150.

## ● Selecting a percussion group

The TD-10 contains four percussion groups and you can assign one group per kit. When editing sounds in the percussion group, you can play them from an external MIDI controller or use the (PREVIEW) button. The position of the cursor will determine which sound is assigned to the PREVIEW button.

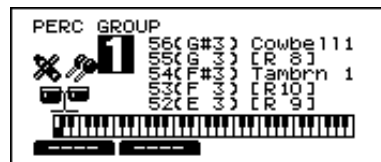

### Procedure

1. Press [KIT]-[F2 (FUNC)]-[F1 (PRCGRP)]. The “PERC GROUP” page will appear.
2. Use [CURSOR] to move the cursor to the “GROUP” number.
3. Use [INC/DEC] or the VALUE dial to select the group.

### Parameters

Group: 1–4

## ● Selecting percussion instruments

Here’s how to select the instrument for each note number of the percussion group.

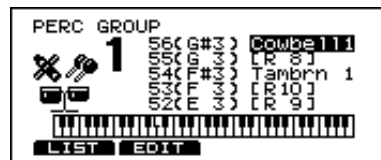

### Procedure

1. Press [KIT]-[F2 (FUNC)]-[F1 (PRCGRP)]. The “PERC GROUP” page will appear.
  2. Use [CURSOR] (left/right) to move the cursor to the instrument name.
  3. Use [CURSOR] (up/down) to move the cursor to the note number whose instrument you wish to change.
- \* Instruments whose group name includes “ELEC,” “TR-808” or “TR-909” cannot be used.
- \* If an indication such as “H1” is displayed at the instrument name, a drum kit instrument is selected. For these note numbers, select an instrument in the “INST” page.
- \* When an external MIDI controller connected, playing a note on the keyboard will move the cursor to the note number that you played. “Note Chase” needs to be “ON” (p. 115).

## Function buttons

When the cursor is located at the instrument name, you can press [F1 (LIST)] to access the instrument list page. Press [F2 (EDIT)] to access the instrument edit page. For details on edit functions, refer to “Percussion group editing.”

## ● Adjusting the volume balance between the drum kit and the percussion group

The volume (Group Volume) and effect send (Group Send Level) can be adjusted for all the drums and for the entire percussion group.

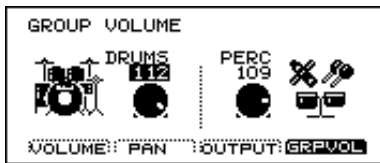

### Procedure (Group Volume)

1. Press [CONTROL ROOM]-[F1 (MIXER)]-[F4 (GRPVOL)]. The “GROUP VOLUME” page will appear.
2. Use [CURSOR] to move the cursor to the group that you wish to set.  
“DRUMS” adjusts the volume of the drum kit, and “PERC” adjusts the volume of the percussion group.
3. Use [INC/DEC] or the VALUE dial to make the setting.

### Parameters

DRUMS, PERC: 0–127

### Procedure (Group Send Level)

1. Press [CONTROL ROOM]-[F4 (EFFECT)]-[F2 (SNDRTN)]. The “EFFECT GROUP” page will appear.
2. Use [CURSOR] to move the cursor to the group that you wish to set.  
“Drums” adjusts the effect send level of the whole drum kit, “Perc” adjusts the effect send level of the percussion group, and “Part” adjusts the send level of the backing part.
3. Use [INC/DEC] or the VALUE dial to make the setting.

### Parameters

Send Level: 0–127

## ● Percussion group editing

Each instrument in the percussion group can be edited.

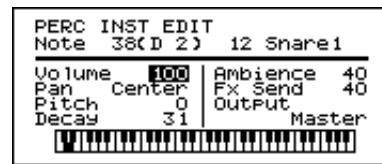

### Procedure

1. Press [KIT]-[F2 (FUNC)]-[F1 (PRCGRP)]-[F2 (EDIT)]. The “PERC INST EDIT” page will appear.
2. Play the external MIDI controller connected to the MIDI IN to select the note number you wish to edit and the corresponding setting page will appear.
3. Use [CURSOR] to move the cursor to the parameter that you wish to set.
4. Use [INC/DEC] or the VALUE dial to make the setting.

### Parameters

#### Note

Move the cursor to the left to select the note number for editing. Move the cursor to the right to select the instrument.

Volume: 0–127

Adjusts the volume.

Pan: L15–CENTER–R15

Adjusts the left/right position.

Pitch: -480–0–+480

Adjusts the pitch of the sound.

Decay: -31–0–31

Adjusts the decay time of the sound.

Ambience: 0–127

Adjusts the ambience send level.

Fx Send: 0–127

Adjusts the effect send level.

Output: Master, Phones Only

You can select “MASTER OUT “PHONES jack only” as output destinations for the percussion group.

## ■ Changing the kit number that is selected by a program change

You can freely select the correspondence between program changes and drum kits, so that (for example) drum kit 10 could be selected when program change number 5 is received.

*\* This would only be used in special cases when using a lot of MIDI information from a sequencer, and using the same program change MIDI channel to change patches in other modules, effect units etc.*

### Procedure

1. Press [SETUP]-[F2 (MIDI)]-[F3 (PROG)].  
The "MIDI Program Change" page will appear.
2. Use [CURSOR] to move the cursor next to the kit name for which you wish to select a program change number.
3. Use [INC/DEC] or the VALUE dial to select the program change number.

## MIDI messages for detailed performance expressions

---

### ■ Messages for hi-hat control

The TD-10's hi-hat controller also transmits the depth to which the pedal is pressed, using control change messages. By default (factory preset), control change 4 is used. Reception/transmission to/from an external MIDI sequencer will use this number.

*\* If the MIDI device that you are using already uses control change number 4 for another function then you can set the hi-hat to use a different control change number.*

### Procedure

1. Press [SETUP]-[F2 (MIDI)]-[F2 (CTRL)].  
The "MIDI Control Change" page will appear.
2. Use [CURSOR] to move the cursor to "Pedal CC."
3. Use [INC/DEC] or the VALUE dial to specify the control change number.

### Parameters

Pedal CC: OFF, Modulation (1), Foot Ctrl (4), General1 (16), General2 (17)

OFF: Hi-hat data control will not be received or transmitted via MIDI IN or MIDI OUT.

Modulation (1), Foot Ctrl (4), General1 (16), General2 (17):  
The specified control change will be used for hi-hat control. This setting will be used both for reception at MIDI IN and for transmission from MIDI OUT.



## ■ Messages for positional sensing (snare drum and ride cymbal only)

The TD-10 uses control change messages to indicate the position a snare pad or ride cymbal pad was hit. The location from the center of the pad outward to the rim is indicated by control change 16 for the snare drum (TRIGGER INPUT jack 2), and by control change 17 for the ride cymbal (TRIGGER INPUT jack 10). These numbers are used for both transmission and reception to/from an external MIDI device.

\* If a MIDI device that you are using already uses control change numbers 16 and 17, you can change these numbers.

### Procedure

1. Press [SETUP]-[F2 (MIDI)]-[F2 (CTRL)].  
The "MIDI Control Change" page will appear.
2. Use [CURSOR] to move the cursor to "SNARE" to make the snare setting, or "RIDE" to make the ride cymbal setting.
3. Use [INC/DEC] or the VALUE dial to specify the control change number.

### Parameters

Zone CC: OFF, Modulation (1), General1 (16), General2 (17)  
OFF: Positional sensing data will not be received or transmitted via MIDI IN and MIDI OUT.

Modulation (1), General1 (16), General2 (17):

Positional sensing data will be handled using the specified control change. This setting is applied to reception via MIDI IN and transmission from MIDI OUT.

## Synchronization with external MIDI devices

This section discusses the settings that allow an external MIDI sequencer and the TD-10's sequencer to be synchronized. The device that is playing back is called the "master" and the device that is synchronizing to the playback is called the "slave".

### About the SYNC parameters

- Internal:** The TD-10's tempo setting will be used for playback/recording. When shipped from the factory, this setting is selected.
- External:** The TD-10's sequencer will operate in accordance with tempo data (MIDI Clock) from the external device.
- Auto:** This is a convenient setting that combines features of both the Internal and External settings. If the TD-10's [PLAY] is pressed when no synchronization signal is being received, pressing the [PLAY] will playback according to the internal setting. When a synchronization signal is being received from an external device, the TD-10 will sync to that signal.
- Remote:** The TD-10 will obey start/pause/stop messages from an external device, but will playback according to its own tempo setting.
- MIDI → Delay:** Tempo messages will be received to control the "Beat Delay" of the effect. Since Song Select and playback start/pause/stop messages will not be received, use this setting when you do not want the internal sequencer to playback in synchronization.

### ● Synchronizing the TD-10 to the playback of an external sequencer

In this case, the TD-10 will be the slave. As shown in the following diagram, use a MIDI cable to connect the MIDI OUT of the external MIDI device to the TD-10's MIDI IN connector.

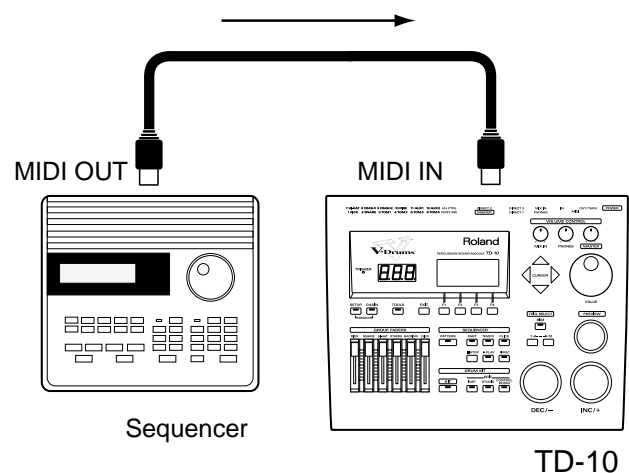

### Procedure

1. Press [PATTERN]-[F2 (FUNC)]-[F1 (GLOBAL)].  
The "PATTERN GLOBAL" page will appear.
2. Use [CURSOR] to move the cursor to "Sync Mode."
3. Use [INC/DEC] or the VALUE dial to select "External" or "Auto."
4. Begin playback on the transmitting device (master).  
Synchronized playback will begin.

### ● Synchronizing an external sequencer to the TD-10

In this case, the TD-10 will be the master. As shown in the following diagram, use a MIDI cable to connect the MIDI OUT of the TD-10 to the MIDI IN connector of the external device.

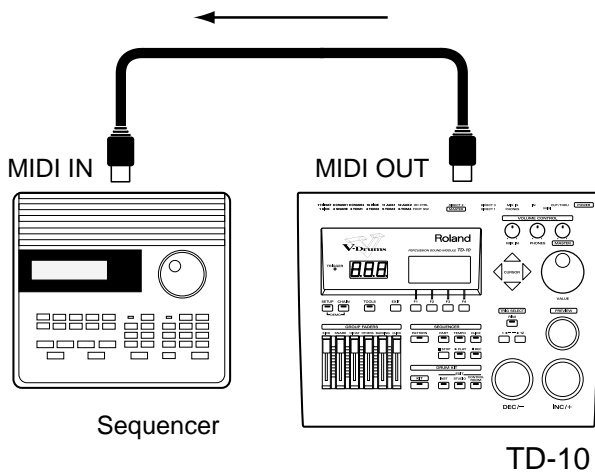

### Procedure

1. Press [PATTERN]-[F2 (SETUP)]-[F1 (GLOBAL)].  
The "PATTERN GLOBAL" page will appear.
2. Use [CURSOR] to move the cursor to "Sync Mode."
3. Use [INC/DEC] or the VALUE dial to "Internal" or "Auto."
4. Make settings on the external sequencer so that it will synchronize.
5. Press [PLAY] to start playback on the TD-10.  
Synchronized playback will begin.

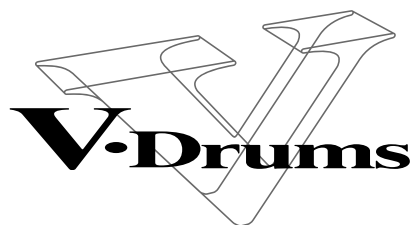

PERCUSSION SOUND MODULE

**TD-10**

# Appendices

Appendices

# Troubleshooting

This section outlines points to check if you experience problems, and what to do about them. For matters related to very basic settings, refer to the “Quick Start,” “Troubleshooting connections and settings.”

## Problems with the overall sound

### ● Does not sound right.

#### Is pad sensitivity adjusted correctly?

→ First refer to the “Quick Start” “Specify the pads that the TD-10 will use” (p. 29), and make sure that trigger settings are correct. If you wish to make additional adjustments to the sensitivity, refer to “Adjusting the sensitivity of a pad” (p. 39). If you are using drum triggers or pads made by another manufacturer, refer to the “Advanced Use” “Basic settings for the trigger parameters (BASIC)” (p. 109) and “Detailed settings for the trigger parameters (ADVNC D)” (p. 111).

### ● No sound

#### Is the volume setting off or too low?

Press the buttons in the order given in the parentheses ( ) to access the appropriate setting page.

- Has the [VOLUME CONTROL] (MASTER) been lowered?  
→ Rotate the [VOLUME CONTROL] knob to be sure.
- Have the [GROUP FADERS] been lowered?  
→ Raise the [GROUP FADERS] sliders.
- Have the Control Room volumes for each instrument been lowered? ([CONTROL ROOM]-[F1 (MIXER)]-[F1 (VOLUME)])  
→ Hit the pad that is not sounding, so that the cursor moves to the slider for that pad. Use [INC/DEC] or the VALUE dial to raise the value.
- Have compressor “Level” settings for each instrument been lowered? ([CONTROL ROOM]-[F2 (COMP)])  
→ Hit the pad that is not sounding, to access the setting page. Press [F4] to select “Level,” and use [INC/DEC] or the VALUE dial to raise the value.
- Has the Control Room (GROUP VOLUME) setting for the overall kit been lowered? ([CONTROL ROOM]-[F1 (MIXER)]-[F4 (GRPVOL)])  
→ Select “DRUM” in the setting page, and use [INC/DEC] or the VALUE dial to raise the value.

#### Are the pads connected correctly?

Make sure that the pad connections are correct, and that each pad is connected to the proper input.

### Has a non-volume parameter been set so that no sound can be output?

Check the following points.

- If you are using brushes, have you selected a special brush kit? ([KIT])  
→ When selecting the drum kit, select one that has the following symbol in the lower right of the display.



- Has the output assignment been changed? ([CONTROL ROOM]-[F1 (MIXER)]-[F3 (OUTPUT)])  
→ Hit the pad that does not sound, so that the cursor moves to the setting for that pad. Use [INC/DEC] or the VALUE dial to select the correct output.
- Is the instrument number set to 600 (OFF)?  
→ Press [INST], and in the screen display which appears, select an instrument numbered 1-559.

### ● No sound when you tap the [PREVIEW]

#### Do you have Local Control (p. 124) set to "OFF"?

Things should be connected/set so performance data that has been routed through the external sequencer (or other device) will be input to the TD-10, as illustrated on p. 124. Local Control should be set to “ON” if an external sequencer is not being used.

### ● Changes in the settings are not reflected in the sound

#### Is the head/rim selection incorrect?

Some parameters can be set independently for the head and the rim. In such cases, take note of the “HEAD” or “RIM” indication in the display screen.

### ● Volume settings don't seem right

#### Check the group faders

If you wish to reproduce the volume balance that was set for the drum kit in the Control Room, set all of the front panel [GROUP FADERS] to the same position.

### ● There is no sound when a pad is struck softly

If a pad was struck while the power was being turned on, the pad will respond poorly when struck softly. Turn off the power. Then turn on the power once again, and do not strike a pad until the drum kit is displayed.

The minimum output level of the pad is detected when the power is turned on. If the pad is struck at this time, the output level of the pad will be detected incorrectly, causing the pad to have poor response.

### ● Rotating [MASTER] does not change the volume

The [MASTER] knob adjusts the volume level from the MASTER jacks, and does not affect the volume of the output from the headphones or the DIRECT 1, 2, 3 outputs.

### ● No Effects

Check the following points by pressing the buttons in the order given in parentheses ( ) and you'll access the appropriate setting page.

- Has the master effect switch been turned off? ([KIT]-[F3 (FX SW)])  
→ Press [F4] to turn it "ON."
- Has the "send" level for each instrument been turned down?(for digital effects) ([CONTROL ROOM]-[F4 (EFFECT)]-[F1 (FXSEND)])  
→ Hit the pad for which no effect is sounding, and the cursor will move to the slider for that pad. Use [INC/DEC] or the VALUE dial to raise the value.
- Has the master level of the effect been turned down? (In the page accessed by [CONTROL ROOM]-[F4 (EFFECT)]-[F2 (SNDRTN)], select "Output Level")  
→ In the setting page, select "Output Level" and use [INC/DEC] or the VALUE dial to raise the value.

### ● No Ambience

Check the following points by pressing the buttons in the order given in parentheses ( ) and you'll access the appropriate setting page.

- Has the master ambience switch been turned off? ([KIT]-[F3 (FX SW)])  
→ Press [F1] to turn it "ON."
- Has the "send" level for each instrument been turned down? ([STUDIO]-[F4 (AMBNCE)]-[F1 (AMBSND)])  
→ Hit the pad for which no ambience is heard, and the cursor will move to the slider for that pad. Use [INC/DEC] or the VALUE dial to raise the value.
- Has the ambience group send level been turned down? ([STUDIO]-[F4 (AMBNCE)]-[F2 (GRPSND)])  
→ Select the group to which ambience does not apply ("DRUMS", "PERC", "PART" ), and use [INC/DEC] or the VALUE dial to raise the value.
- Has the level of the ambience output destination been lowered? ([STUDIO]-[F4 (AMBNCE)]-[F3 (AMBLVL)])  
→ Select the output destination ("MASTER", "DIR1", "DIR2", "DIR3" ), and use [INC/DEC] or the VALUE dial to raise the value.
- The volume level of the instrument connected to MIX IN jack is too low.
- Could you be using a connection cable that contains a resistor?  
Use a connection cable that does not contain a resistor.

### ● Equalizer doesn't work (individual or MASTER)

Check the following points by pressing the buttons in the order given in parentheses ( ) and you'll access the appropriate setting page.

- Has the switch that turns the equalizer on/off for each kit been turned off? ([KIT]-[F3 (FX SW)])  
→ Press [F3] to turn it "ON."
- Has the master equalizer switch been turned off? ([KIT]-[F4 (MAS EQ)])  
→ Press [F1] to turn it "ON."
- Has the equalizer switch for each pad been turned off? ([CONTROL ROOM]-[F3 (EQ)])  
→ Hit the pad for which no equalization is heard and the setting page for that pad will appear.  
Press [F1] to turn the setting "ON."

### ● Compressor doesn't work

- Has the switch which turns the compressor on/off for each kit been turned off? ([KIT]-[F3 (FX SW)])  
→ Press [F2] to turn it "ON."
- Has the compressor switch for each pad been turned off? ([CONTROL ROOM]-[F2 (COMP)])  
→ Hit the pad for which no compression is heard so that the setting page for that pad appears. Press [F1] to turn the setting "ON."
- Are the compressor settings correct? ([CONTROL ROOM]-[F2 (COMP)])  
→ Refer to the explanations on p. 91 and correct the compressor settings.

## Concerning pads and pedals

### ● Playing velocity doesn't correspond to the resulting sound

First refer to the "Quick Start" "Specify the pads that the TD-10 will use" (p. 29) and make sure that the basic settings are correct. If this does not solve the problem or if you are using pads made by another manufacturer, refer to "Adjusting the sensitivity of a pad" (p. 39) and make detailed settings.

### ● An instrument other than the one assigned is heard

When you hit a pad have the head/rim assignments been inverted? Also, simultaneously striking the head and rim (Rim Shot) will trigger the instrument assigned to the rim. If you wish to play the sound that is assigned to the head, be sure to strike only the head.

### ● Have you changed the "SCAN TIME" setting (p. 111) after selecting the "TRIGGER TYPE" (p. 108)?

The head tension adjustment (p. 110) does not work correctly when the "SCAN TIME" setting is excessively low. This setting is automatically set to the most efficient values for each pad when you select the "TRIGGER TYPE" again.

### ● Hi-hat control pedal (FD-7) does not operate correctly

The hi-hat control pedal was not detected correctly at power-on. Turn off the power. Then turn on the power once again, and do not operate the hi-hat control pedal (FD-7) until the drum kit display appears.

The position of the pedal when open is detected when the power is turned on. If the pedal was pressed while the power was being turned on, the pedal position will be detected incorrectly, and the pedal will not operate correctly.

## MIDI-related problems

---

### ● No Sound when using an external controller (sequencer, keyboard etc.)

**Has an internal volume setting been lowered?**

Check the following points. Pressing the buttons in the order given in parentheses ( ) will access the appropriate setting page.

- Has the individual volume for each instrument in the percussion group been lowered? ([KIT]-[F2 (FUNC)]-[F1 (PRCGRP)]-[F2 (EDIT)])
- Move the cursor to "Note," and select the note which is not sounding. Next select "Volume," and use [INC/DEC] or the VALUE dial to increase the value.
- Has the Control Room volume for the entire percussion group been lowered? ([CONTROL ROOM]-[F1 (MIXER)]-[F4 (GRPVOL)])
- In the setting page select "PERC," and use [INC/DEC] or the VALUE dial to raise the value.
- Have output assignments been changed? ([CONTROL ROOM]-[F1 (MIXER)]-[F3 (OUTPUT)]) (With the factory settings, the sound will be output only from the MASTER OUT and PHONES jacks.)
- Use [INC/DEC] or the VALUE dial to specify the correct output destination ("MASTER", "DIR1", "DIR2", "DIR3").
- Has the MIDI channel of the part been turned off or changed? ([SETUP]-[F2 (MIDI)])
- If the "Channel" column of the setting page indicates "OFF," move the cursor to that value and use [INC/DEC] or the VALUE dial to specify the MIDI channel.

### ● Bulk dump is not transmitted.

**Is the MIDI cable connected properly?**

If you wish to save a bulk dump on an external device, connect the TD-10's MIDI OUT/THRU connector to the external sequencer's MIDI IN connector. Also, make sure that reception of system exclusive messages is not turned off on the external sequencer. System exclusive data is data unique to individual devices, so verify all settings.

## Sequencer-related problems

---

### ● Pressing [PLAY] does not start playback

**Are you playing back an empty pattern?**

Playback a pattern which contains musical data.

**Is a part muted?**

In the page that appears when you press [PART]-[F4 (MUTE)], if "MUTE" is indicated for any parts, press [F1]-[F4] to switch these settings to "PLAY."

### ● Did playback occur for a moment and then stop immediately?

**Is the playback type (PLAY TYPE) set to "Tap"?**

This type is used mainly when pads are used to playback a pattern step by step. In the page that appears when you press [PATTERN]-[F2 (FUNC)] [F3 (TYPE)], set "Play Type" to a setting other than "Tap."

## Click-related problems

---

### ● Click does not sound

**Is the [CLICK] indicator lit?**

If it is not lit, press [CLICK] to make it light. At this time, the click setting page appears, and you should hear the click sound. If not, then see below or press [EXIT] to exit the page.

**Has the [GROUP FADERS] slider [CLICK] been lowered?**

→ Raise the [CLICK] slider.

**Is the output destination of the click sound correct?**

In the page that appears when you press [CLICK]-[F2 (INST)], move the cursor to "Output." If this is set to "MASTER," the click will be output from MASTER OUT and the PHONES. If set to "PHONES," the click will be output from the headphones ONLY.

## Display-related problems

### ● Trigger indicators light on their own

If a monitor speaker or the like is sounding at a high volume nearby a pad, the vibration can sometimes be detected by the pad as a trigger signal. If this occurs, either move the speaker, or change the angle of the pad. Also verify the mounting of the pads and that the stand is stable in order to eliminate excess vibrations.

### ● Display is too light or too dark

The visibility of the display will change depending on the viewing angle and on room lighting conditions. Re-adjust the setting in the page that is displayed when you press [SETUP]-[F3 (CTRL)]-[F3 (DISPLY)], or hold down [KIT] and rotate the VALUE dial to make the setting. (easiest way).

## Other

### ● Hitting [PREVIEW] plays back a pattern.

#### Is a pad pattern assigned to the pad?

In this case, using [PREVIEW] to play this pad will have the same result as striking the pad, and the pattern will playback. To stop playback, press [STOP].

### ● Sounds of other instruments are audible when using the DIRECT jacks

**The ambience component of the tone being output from a DIRECT jack is being heard from the MASTER jack. Turn the ambience to "OFF" (p. 41), or set the "AMBIENCE Output Level" to "0" (p. 88).**

Regardless of the sound output assignments (Output Assign; p. 91), all of the ambience sounds are mixed into two channels, (L) and (R), and sent to the outputs selected with the "AMBIENCE Output Level" setting (p. 88). Therefore, sounds may be audible through a different output than the output assigned for the instrument itself due to the "AMBIENCE Output Level" setting.

For example, if the factory settings are changed so that the kick is output from the DIRECT jack, the ambience sounds are still to be output from the MASTER jack; as a result, the kick sound could be perceived as seeping from the MASTER jack.

### Low-level crosstalk (-45 dB or lower) is perceived at another output connector.

This is within the TD-10's specifications, so it should not be a source for concern.

Output Separation: 76 dB (min.)

(MASTER L -> DIRECT L, MASTER R -> DIRECT R): 45 dB (min.)

(DIRECT L -> Other DIRECT L, DIRECT R -> Other DIRECT R): 45 dB (min.)

# Instruments that can be used with each trigger

The instruments that can be assigned to each trigger are as follows.

- : The instrument can be assigned and V-EDIT is possible
- ▲: The instrument can be assigned, but V-EDIT is not possible
- X: Cannot be assigned

Trigger number	1	2	3	4	5	6	7	8	9	10	11	12
Inst group \	KICK	SNARE	TOM1	TOM2	TOM3	TOM4	HI-HAT	CRASH1	CRASH2	RIDE	AUX1	AUX2
V-KICK	●	▲	▲	▲	▲	▲	▲	▲	▲	▲	▲	▲
V-SNARE	▲	●	▲	▲	▲	▲	▲	▲	▲	▲	▲	▲
V-TOM	▲	▲	●	●	●	●	▲	▲	▲	▲	▲	▲
ELEC KICK	●	X	X	X	X	X	X	X	X	X	X	X
ELEC SNARE	X	●	X	X	X	X	X	X	X	X	X	X
ELEC TOM1	X	X	●	X	X	X	X	X	X	X	X	X
ELEC TOM2	X	X	X	●	X	X	X	X	X	X	X	X
ELEC TOM3	X	X	X	X	●	X	X	X	X	X	X	X
ELEC TOM4	X	X	X	X	X	●	X	X	X	X	X	X
808 KICK	●	X	X	X	X	X	X	X	X	X	X	X
808 SNARE	X	●	X	X	X	X	X	X	X	X	X	X
808 TOM1	X	X	●	X	X	X	X	X	X	X	X	X
808 TOM2	X	X	X	●	X	X	X	X	X	X	X	X
808 TOM3	X	X	X	X	●	X	X	X	X	X	X	X
808 TOM4	X	X	X	X	X	●	X	X	X	X	X	X
909 KICK	●	X	X	X	X	X	X	X	X	X	X	X
909 SNARE	X	●	X	X	X	X	X	X	X	X	X	X
909 TOM1	X	X	●	X	X	X	X	X	X	X	X	X
909 TOM2	X	X	X	●	X	X	X	X	X	X	X	X
909 TOM3	X	X	X	X	●	X	X	X	X	X	X	X
909 TOM4	X	X	X	X	X	●	X	X	X	X	X	X
Other	▲	▲	▲	▲	▲	▲	▲	▲	▲	▲	▲	▲

\* On instruments with a group name that includes "ELEC", "808", or "909," the combination of head and rim cannot be modified.

**VERY IMPORTANT:** If you assign two different "V" sounds from the same instrument group, to the head and rim, the choices made when editing (shell depth, head type etc.) will apply for both sounds. For the sound assigned to the rim, the ONLY individual edit parameter available is head tuning.

## ■ Parameters that can be set independently for the head and rim

[INST] parameters:

Pitch, Decay (except for "V-EDIT" sounds)

[STUDIO] parameters:

Amb Send Level (except for ELEC, 808 or 909 sounds)

[CONTROL ROOM] parameters:

MIXER/Volume, MIXER/Fx Send (except for ELEC, 808 or 909 sounds)

[INST]-[F4 (CTRL)]-[F4 (MIDI)] parameters:

TRIGGER to PATTERN, Gate Time, Note No.

[INST]-[F4 (CONTROL)]-[F3 (PATTERN)] parameters:

TRIGGER to PATTERN



# Restoring the factory settings (INITIALIZE)

If you wish to restore all internal settings to the factory preset values use the Initialize operation explained below. All internal settings will be lost when you perform the Initialize operation, so if necessary, save your data to a memory card or on an external MIDI device before initializing.

## Procedure

1. Press [SETUP]-[F4 (UTIL)]-[F4 (INIT)].  
The "SYSTEM INITIALIZE" page will appear.
2. Press [F4 (INIT)].  
A confirmation display will appear.
3. Press [F4 (EXEC)] and the TD-10's data will be initialized.  
(Press [F1 (CANCEL)] to return to the previous page without executing the operation.)

How to recall original factory presets for individual drum kits, percussion groups and trigger banks.



(Example)

Initializing individual Drum kits.

1. Press [KIT].  
The "DRUM KIT" page appears.
2. Press [TOOLS]-[F1 (Copy)].  
The "COPY DRUM KIT" page appears, showing the source and destination positions.
3. Use [INC/DEC] or the VALUE dial to, scroll until you see "PRESET" in front of the drum kit you wish to recall.
4. Press [F4 (COPY)].  
A confirmation display will appear.
5. Then press [F4 (EXEC)] and the data will be restored.  
(Press [F1 (CANCEL)] to return to the previous page without executing out the operation.)

# Message / error message list

This section lists the messages (error messages) that the TD-10 produces and explains the meaning of each message, giving you the appropriate action to take. If the TD-10 is not able to operate correctly or if an incorrect operation was performed, a message window will appear in the screen. Read this section and take the appropriate action.

When an indication of "ACCEPT" is shown above [F4] as in the following figure, pressing that button will close the message window.



## Backup Battery Low !

The internal backup battery of the TD-10 (a battery that maintains data in the user memory) has run down. Contact your dealer or a nearby Roland service center to have the battery replaced.

## BACKUP NG !

The backup battery has run down completely, and the internal data has been lost. Contact your dealer or a nearby Roland service center to have the battery replaced.

## BULK DUMP Aborted by User !

Bulk data transmission was halted.

## Check Sum Error !

The checksum value of a system exclusive message was incorrect.

## BULK DUMP Data Transmit Completed !

Bulk data transmission was completed.

## BULK DATA DEVICE ID Error !

Due to an incorrect Device ID, the system exclusive message could not be received. Set the correct Device ID (p. 122).

## BULK DATA Load Error !

Reception of bulk dump failed. Make sure that all MIDI cables are firmly connected (p. 122).

## BULK DATA Receiving ... Please, Wait.

Bulk data is now being received. (Don't touch any buttons or pad during this process).

## BULK DATA Receive Completed !

Bulk data reception has ended.

## Empty Pattern

You attempted to perform an editing operation on an empty pattern.

## EXPANSION BOARD Not Ready or Unavailable !

Either the expansion board has been removed or was not installed correctly (p. 43).

## ILLEGAL CARD

This message may be due to one of the following two reasons:

1. Check whether the card has been used by a different Roland device.

Check whether the card has been used by a different Roland device. If you wish to erase the contents of the card and use it with the TD-10, press [F4 (ACCEPT)]. The card initialize page will appear. In this page, press [F4 (INIT)] and you will be asked whether it is OK to erase the contents of the card. To initialize the card, press [F4]. To cancel, press [F1].

2. Make sure that you are using an "M-512E" card ONLY.

## MEMORY CARD Battery Low ! Please Change !

The backup battery of the memory card has run down. Refer to the owner's manual for your memory card, and replace the battery.

## MEMORY CARD Data Error !

There is a problem in the data of the memory card. If the power is turned off or the card removed while data is being written into the card (SAVE), the data in the card will be damaged. Format the card once again before using it (p. 114).

## MEMORY CARD Data Load Completed !

Data has been loaded from the memory card.

## MEMORY CARD Data Save Completed !

Data has been saved to the memory card.

## MEMORY CARD Not Ready !

A pattern or drum kit chain attempted to access data from a memory card. Insert the memory card.

## MEMORY CARD Write Protected.

The memory card is write protected (switch in the "write prohibit" position), and data could not be saved. Move the write protect switch of the card to allow data to be saved (p. 114).

**MIDI Buffer Full !**

A large amount of MIDI messages were received in a short time, and could not be processed completely. Make sure that a problem has not occurred with the MIDI cable connection or with your external MIDI device.

**Data Overload**

Pattern contained an excessive amount of data, and as a result could not be output successfully from MIDI OUT. Try eliminating a track that has too much data.

**MIDI Offline !**

A MIDI cable was disconnected. (Or communication with the external MIDI device stopped for some reason.)

**PATTERN DATA Not enough memory !**

The internal memory for pattern storage is full. Save the patterns either to a memory card (p. 114) or to an external device via bulk dump, (p. 121) and then delete some or all of the internal patterns (p. 105).

**SYSTEM ERROR**

A problem has occurred with the internal system. Contact your dealer or a nearby Roland service center.

**SYSTEM INITIALIZE Completed !**

Initialization of the TD-10's internal data has been completed.

**No Empty Pattern**

There are no more empty patterns. Clear unneeded patterns before using this function (p. 105).

**Not Enough Memory**

Pattern recording or editing could not be carried out because there was not enough internal memory. Try again after deleting patterns that are no longer needed.

# About MIDI

MIDI means “Musical Instrument Digital Interface”. By using MIDI you can play and/or control multiple instruments from a single MIDI controller, keyboard or sequencer, and is a world-wide standard, allowing communication between MIDI equipped instruments, no matter who manufactured them.

If you wish to use a MIDI keyboard to record on the TD-10, or to use an external sequencer to play the TD-10, we suggest that you understand the explanations that follow.

## MIDI connectors

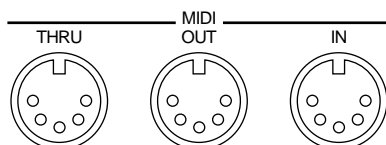

### MIDI IN

This connector receives messages from external MIDI devices (keyboards, sequencers controllers etc.) to play the TD-10's instruments or change its settings.

### MIDI OUT

The TD-10 transmits musical data from its sequencer or pads via the MIDI OUT, and can also use this connector save internal song data and settings to an external sequencer for back-up purposes.

### MIDI THRU

All messages received at MIDI IN are re-transmitted from this connector. (if Soft Thru is “ON”) refer to “Chapter 10. Functions using MIDI,” and read the section “Using the TD-10 with the Roland SPD-11” (p. 123). This connector is used when you wish to transmit the same stream of MIDI data to other devices. With the factory settings, this connector will function as MIDI OUT only.

## MIDI channels and multi-timbral sound sources

MIDI transmits many types of data over a single MIDI cable. This is made possible by the concept of MIDI channels which allow a device to distinguish the data that is or is not intended for it. In some ways, MIDI channels are similar to television channels. By changing the channel on a television set, you can view the programs that are being broadcast by different stations. In the same way, MIDI also allows a device to select the information intended for that device out of the variety of information that is being transmitted to it.

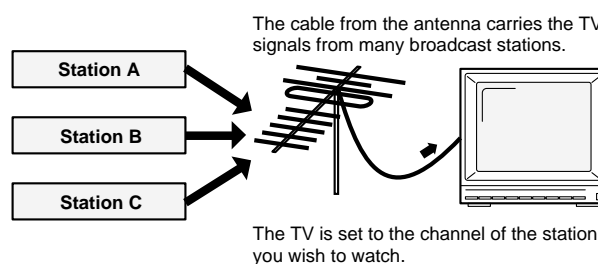

MIDI uses sixteen channels; 1 through 16. Set the receiving device so that it will receive only the channel that it needs to receive. In the example below, the transmitting device is transmitting on channels 1 and 2, but sound module A has been set to receive only channel 1, and sound module B has been set to receive only channel 2. In this way, sound module A plays the guitar part and sound module B plays the bass part.

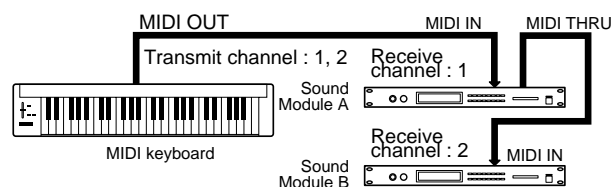

When the TD-10 is used as a sound module, it can function on four different channels simultaneously. This means that a single TD-10 can play a four-part ensemble. Sound modules like the TD-10 which can receive multiple MIDI channels at once to play different sounds on each channel are called “multi-timbral sound modules.”

## How the sequencer operates

A sequencer is an electronic musical device that records and plays back performance data, meaning the note you play, how long it is held (gate time) and velocity with which you play, and various controller functions. The TD-10 contains a built-in sequencer with 50 preset patterns containing pre-programmed musical data. You can also create your own patterns.

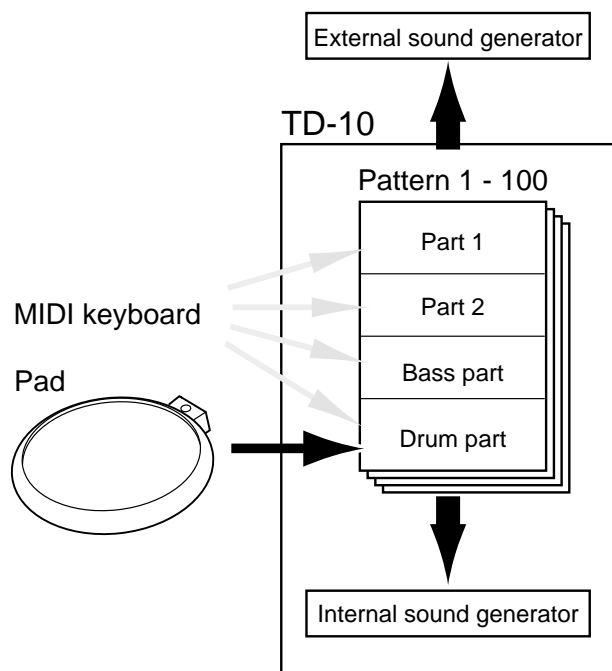

During playback, data recorded in the sequencer is transmitted to the sound module and played. As shown in the diagram above, each track is transmitted to the respective part; track 1 plays part 1 and track 2 plays part 2, and so forth. During recording, the performance information from the pads or MIDI keyboard is transmitted to the sequencer, and the data is then transmitted to the sound module for playback.

A percussion group allows 60 types of instrument to be played via MIDI in addition to all the instruments of the drum kit. You can use instruments of the percussion group when using an external MIDI controller or keyboard to record on to the drum track.

# Using drum triggers

This section explains how to attach an acoustic drum trigger.

## Procedure

1. Attach the drum trigger to the acoustic drum.

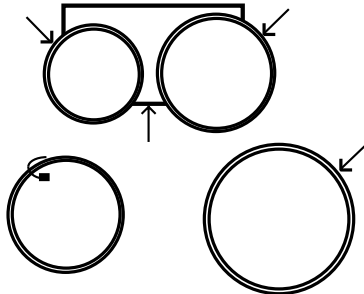

Snare drum

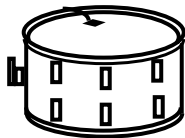

Tom tom

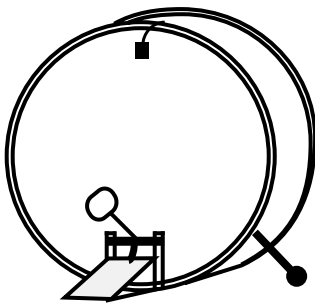
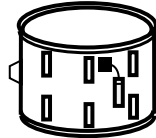

Kick

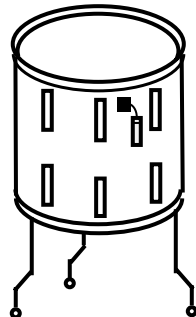

Floor tom

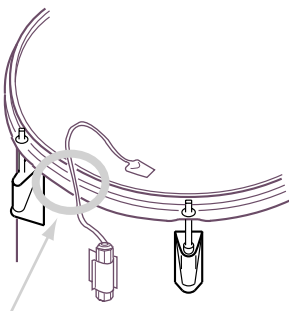

Make sure that the wire does not touch

Drum	Where to Install
Kick	On the playing head (5 to 10 cm from the rim)
Snare drum	On the playing head (2 to 3 cm from the rim)
Tom tom	On the shell (next to a lug located about 1 cm from the playing head rim)
Floor tom	On the shell (next to a lug located about 1 cm from the playing head rim)

\* If the drum trigger of a tom has a low output level, attach it to the head.

2. Use a monaural cable to connect the drum trigger to the TD-10's TRIGGER INPUT jack.

Drum	TRIGGER INPUT jack
Kick	1
Snare drum	2
Tom tom	3-6

3. Make trigger settings on the TD-10.

Press [SETUP]-[F1 (TRIG)]-[F1 (BANK)] to access the setting page. Next, use [CURSOR] to move the cursor to the trigger number that you wish to set, and use [INC/DEC] or the VALUE dial to set the trigger parameters as shown in the following display.

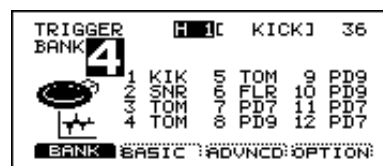

4. When you hit the drum, the TD-10 will be triggered. If it does not sound correctly, try changing the position of the drum trigger, or refer to "The order in which trigger parameters should be set when using drum triggers" (p. 112) and make adjustments.

\* So that the drum trigger does not pick up extraneous vibrations, do not allow its cable to contact the rim or shell (body).

\* Be sure to mute the bass drum and snare drum. If you use a ring mute, cut away part of the ring mute, so the drum trigger contacts the head directly.

\* For details on adjusting the correspondence between playing velocity and the TD-10's volume, refer to p. 37 of the "Quick Start," and "Basic settings for the trigger parameters" (p. 109).

# Preset list

## ■ Drum kit list

No.	Kit name	Percussion group	Remark
1	StudioV	1	
2	BigRock	1	
3	Tight	1	
4	JazzSizl	1	
5	SuperBwl	1	
6	Freak'n	1	
7	OldScool	1	*1
8	TexMex	1	*2
9	GroovIn	1	
10	BtDelayy	1	
11	LatinSet	1	
12	Orch Set	1	
13	BrasRing	1	
14	TR-808	1	*2
15	TR-909	1	*2
16	Dr Spin	1	
17	Memphis	1	
18	Cartoon	3	
19	KornBall	1	*2
20	X-Stick	1	
21	BIG Band	1	
22	lowFI	1	
23	CarTUNE	1	
24	Natural	1	
25	Dirty	1	

No.	Kit name	Percussion group	Remark
26	Far East	1	
27	SnareBuz	1	
28	HEAVy	1	
29	NextDoor	1	
30	Latin 3D	1	
31	Vintage	1	
32	MIDIbrsh	1	
33	SockHop	1	
34	Woody	1	
35	GoFigure	1	
36	70'sRock	1	
37	Brushes	1	*1
38	Electro	1	*2
39	Rock	1	
40	Analog	1	*2
41	Fusion	1	
42	Jazz	1	
43	SLAPBACK	1	
44	COMpress	1	
45	LivnRoom	1	
46	KitCopy1	1	
47	KitCopy2	1	
48	KitCopy3	1	
49	KitCopy4	1	
50	KitCopy5	1	

\*1 indicates a kit to be played with brushes.

\*2 indicates a kit using sounds referred to “#” on page 144–147. When these sounds are used a bit more time is needed when changing kits.

## ■ Drum instrument list

No.	Inst name	Inst group	Remark
1	VintageK	V-KICK	
2	26"DeepK	V-KICK	
3	ThickHdK	V-KICK	
4	Round K	V-KICK	
5	Medium K	V-KICK	
6	BigRoomK	V-KICK	
7	Big K	V-KICK	
8	BigLow K	V-KICK	
9	Studio1K	V-KICK	
10	Studio2K	V-KICK	
11	Studio3K	V-KICK	
12	Studio4K	V-KICK	
13	Studio5K	V-KICK	
14	Studio6K	V-KICK	
15	Studio7K	V-KICK	
16	Studio8K	V-KICK	
17	Room 1 K	V-KICK	
18	Room 2 K	V-KICK	
19	Room 3 K	V-KICK	
20	Room 4 K	V-KICK	
21	Room 5 K	V-KICK	
22	Room 6 K	V-KICK	
23	Solid1 K	V-KICK	
24	Solid2 K	V-KICK	
25	Jazz 1 K	V-KICK	
26	Jazz 2 K	V-KICK	
27	18"JazzK	V-KICK	
28	BrshHitK	V-KICK	
29	Wood 1 K	V-KICK	
30	Wood 2 K	V-KICK	
31	Wood 3 K	V-KICK	
32	Maple1 K	V-KICK	
33	Maple2 K	V-KICK	
34	Oak K	V-KICK	
35	Birch K	V-KICK	
36	RoseWodK	V-KICK	
37	OnePly K	V-KICK	
38	WdBeatrK	V-KICK	
39	TakaokaK	V-KICK	
40	Oyster K	V-KICK	
41	Open K	V-KICK	
42	26"HardK	V-KICK	
43	Dry K	V-KICK	
44	DryMed K	V-KICK	
45	DryHardK	V-KICK	
46	DeepDryK	V-KICK	
47	Fusion K	V-KICK	
48	Meat K	V-KICK	
49	SandBagK	V-KICK	
50	BsktBalK	V-KICK	

No.	Inst name	Inst group	Remark
51	MondVrbK	V-KICK	
52	Sizzle K	V-KICK	
53	NailHitK	V-KICK	
54	Box K	V-KICK	
55	Dance K	V-KICK	
56	House K	V-KICK	
57	Pillow K	V-KICK	
58	Rap K	V-KICK	
59	Hard808K	V-KICK	
60	Boom808K	V-KICK	
61	Noiz808K	V-KICK	
62	Real909K	V-KICK	
63	Wood909K	V-KICK	
64	909HdAtK	V-KICK	
65	ElephntK	V-KICK	
66	Cattle K	V-KICK	
67	Giant K	V-KICK	
68	Door K	V-KICK	
69	Punch K	V-KICK	
70	MachineK	V-KICK	
71	Broken K	V-KICK	
72	BendUp K	V-KICK	
73	HrdNoizK	V-KICK	
74	Trip K	V-KICK	
75	Splat K	V-KICK	
76	Scrach1K	V-KICK	
77	Scrach2K	V-KICK	
78	Hi-Q K	V-KICK	
79	Space K	V-KICK	
80	SynBassK	V-KICK	
81	Elec K	ELEC KICK	#
82	TR808 K	TR808 KICK	#
83	TR909 K	TR909 KICK	#
84	PicololS	V-SNARE	*2
85	PcolRimS	V-SNARE	
86	Picolo2S	V-SNARE	*2
87	Pco2RimS	V-SNARE	
88	Picolo3S	V-SNARE	*2
89	Pco3RimS	V-SNARE	
90	Medium1S	V-SNARE	*2
91	Med1RimS	V-SNARE	
92	Medium2S	V-SNARE	*2
93	Med2RimS	V-SNARE	
94	Medium3S	V-SNARE	*2
95	Med3RimS	V-SNARE	
96	Medium4S	V-SNARE	*2
97	Med4RimS	V-SNARE	
98	Fat1 S	V-SNARE	*2
99	Fat1RimS	V-SNARE	
100	Fat2 S	V-SNARE	*2



No.	Inst name	Inst group	Remark
101	Fat2RimS	V-SNARE	
102	AcousticS	V-SNARE	*2
103	AcusRimS	V-SNARE	
104	VintageS	V-SNARE	*2
105	VntgRimS	V-SNARE	
106	Maple1 S	V-SNARE	*2
107	Mpl1RimS	V-SNARE	
108	Jazz S	V-SNARE	*2
109	JazzRimS	V-SNARE	
110	Elec S	ELEC SNARE	#
111	TR808 S	TR808 SNARE	#
112	TR909 S	TR909 SNARE	#
113	Brush1 S	SNARE	*1
114	Brush2 S	SNARE	*1
115	BrshTmbS	SNARE	*1
116	MIDIBr1S	SNARE	
117	MIDIBr2S	SNARE	
118	Ballad S	SNARE	
119	Ring S	SNARE	
120	RingRimS	SNARE	
121	13" S	SNARE	
122	13" RimS	SNARE	
123	Rock S	SNARE	
124	RockRimS	SNARE	
125	TD7MpleS	SNARE	
126	TDMplRmS	SNARE	
127	R8MapleS	SNARE	
128	R8MplRmS	SNARE	
129	Funk S	SNARE	
130	FunkRimS	SNARE	
131	Bop S	SNARE	
132	Bop RimS	SNARE	
133	Bronze S	SNARE	
134	BrnzRimS	SNARE	
135	Picolo4S	SNARE	
136	Pco4RimS	SNARE	
137	Picolo5S	SNARE	
138	Pco5RimS	SNARE	
139	Picolo6S	SNARE	
140	Pco6RimS	SNARE	
141	Medium5S	SNARE	
142	Med5RimS	SNARE	
143	Medium6S	SNARE	
144	Med6RimS	SNARE	
145	Medium7S	SNARE	
146	Med7RimS	SNARE	
147	Medium8S	SNARE	
148	Med8RimS	SNARE	
149	Fat3 S	SNARE	
150	Fat3RimS	SNARE	
151	Fat4 S	SNARE	
152	Fat4RimS	SNARE	

No.	Inst name	Inst group	Remark
153	Fat5 S	SNARE	
154	Fat5RimS	SNARE	
155	DynamicS	SNARE	
156	DynmcRmS	SNARE	
157	Roll S	SNARE	
158	Buzz S	SNARE	
159	NoSnareS	SNARE	
160	Dopin1 S	SNARE	
161	Dopin2 S	SNARE	
162	Reggae S	SNARE	
163	HrdNoizS	SNARE	
164	Cruddy S	SNARE	
165	Dancel S	SNARE	
166	Dance2 S	SNARE	
167	Anvil S	SNARE	
168	House S	SNARE	
169	HousDpnS	SNARE	
170	HipHop S	SNARE	
171	Real808S	SNARE	
172	Real909S	SNARE	
173	Chu-Hi S	SNARE	
174	Clap! S	SNARE	
175	R70Pwr S	SNARE	
176	Whack S	SNARE	
177	CrsStk 1	SNARE	
178	CrsStk 2	SNARE	
179	CrsStk 3	SNARE	
180	CrsStk 4	SNARE	
181	CrsStk 5	SNARE	
182	CrsStk 6	SNARE	
183	808Crstk	SNARE	
184	Fibre T1	V-TOM	
185	Fibre T2	V-TOM	
186	Fibre T3	V-TOM	
187	Fibre T4	V-TOM	
188	Dry T1	V-TOM	
189	Dry T2	V-TOM	
190	Dry T3	V-TOM	
191	Dry T4	V-TOM	
192	NaturlT1	V-TOM	
193	NaturlT2	V-TOM	
194	NaturlT3	V-TOM	
195	NaturlT4	V-TOM	
196	StudioT1	V-TOM	
197	StudioT2	V-TOM	
198	StudioT3	V-TOM	
199	StudioT4	V-TOM	
200	Maple T1	V-TOM	
201	Maple T2	V-TOM	
202	Maple T3	V-TOM	
203	Maple T4	V-TOM	
204	Jazz T1	V-TOM	

## Preset list

No.	Inst name	Inst group	Remark
205	Jazz T2	V-TOM	
206	Jazz T3	V-TOM	
207	Jazz T4	V-TOM	
208	Buzz T1	V-TOM	
209	Buzz T2	V-TOM	
210	Buzz T3	V-TOM	
211	Buzz T4	V-TOM	
212	Slap T1	V-TOM	
213	Slap T2	V-TOM	
214	Slap T3	V-TOM	
215	Slap T4	V-TOM	
216	Rock T1	V-TOM	
217	Rock T2	V-TOM	
218	Rock T3	V-TOM	
219	Rock T4	V-TOM	
220	Room T1	V-TOM	
221	Room T2	V-TOM	
222	Room T3	V-TOM	
223	Room T4	V-TOM	
224	Big T1	V-TOM	
225	Big T2	V-TOM	
226	Big T3	V-TOM	
227	Big T4	V-TOM	
228	Punch T1	V-TOM	
229	Punch T2	V-TOM	
230	Punch T3	V-TOM	
231	Punch T4	V-TOM	
232	Brsh1 T1	V-TOM	
233	Brsh1 T2	V-TOM	
234	Brsh1 T3	V-TOM	
235	Brsh1 T4	V-TOM	
236	Brsh2 T1	V-TOM	
237	Brsh2 T2	V-TOM	
238	Brsh2 T3	V-TOM	
239	Brsh2 T4	V-TOM	
240	Oak T1	V-TOM	
241	Oak T2	V-TOM	
242	Oak T3	V-TOM	
243	Oak T4	V-TOM	
244	VintgeT1	V-TOM	
245	VintgeT2	V-TOM	
246	VintgeT3	V-TOM	
247	VintgeT4	V-TOM	
248	Dark T1	V-TOM	
249	Dark T2	V-TOM	
250	Dark T3	V-TOM	
251	Dark T4	V-TOM	
252	FusionT1	V-TOM	
253	FusionT2	V-TOM	
254	FusionT3	V-TOM	
255	FusionT4	V-TOM	
256	AttackT1	V-TOM	

No.	Inst name	Inst group	Remark
257	AttackT2	V-TOM	
258	AttackT3	V-TOM	
259	AttackT4	V-TOM	
260	Hall T1	V-TOM	
261	Hall T2	V-TOM	
262	Hall T3	V-TOM	
263	Hall T4	V-TOM	
264	Birch T1	V-TOM	
265	Birch T2	V-TOM	
266	Birch T3	V-TOM	
267	Birch T4	V-TOM	
268	Beech T1	V-TOM	
269	Beech T2	V-TOM	
270	Beech T3	V-TOM	
271	Beech T4	V-TOM	
272	Micro T1	V-TOM	
273	Micro T2	V-TOM	
274	Micro T3	V-TOM	
275	Micro T4	V-TOM	
276	Hand T1	V-TOM	
277	Hand T2	V-TOM	
278	Hand T3	V-TOM	
279	Hand T4	V-TOM	
280	Bend T1	V-TOM	
281	Bend T2	V-TOM	
282	Bend T3	V-TOM	
283	Bend T4	V-TOM	
284	Bowl T1	V-TOM	
285	Bowl T2	V-TOM	
286	Bowl T3	V-TOM	
287	Bowl T4	V-TOM	
288	Dirty T1	V-TOM	
289	Dirty T2	V-TOM	
290	Dirty T3	V-TOM	
291	Dirty T4	V-TOM	
292	Space T1	V-TOM	
293	Space T2	V-TOM	
294	Space T3	V-TOM	
295	Space T4	V-TOM	
296	AnalogT1	V-TOM	
297	AnalogT2	V-TOM	
298	AnalogT3	V-TOM	
299	AnalogT4	V-TOM	
300	Noise T1	V-TOM	
301	Noise T2	V-TOM	
302	Noise T3	V-TOM	
303	Noise T4	V-TOM	
304	Elec T1	ELEC TOM1	#
305	Elec T2	ELEC TOM2	#
306	Elec T3	ELEC TOM3	#
307	Elec T4	ELEC TOM4	#
308	TR808 T1	TR808 TOM1	#

No.	Inst name	Inst group	Remark
309	TR808 T2	TR808 TOM2	#
310	TR808 T3	TR808 TOM3	#
311	TR808 T4	TR808 TOM4	#
312	TR909 T1	TR909 TOM1	#
313	TR909 T2	TR909 TOM2	#
314	TR909 T3	TR909 TOM3	#
315	TR909 T4	TR909 TOM4	#
316	Pure HH	HI-HAT	
317	BrightHH	HI-HAT	
318	Jazz HH	HI-HAT	
319	Thin HH	HI-HAT	
320	Pop HH	HI-HAT	
321	Heavy HH	HI-HAT	
322	Dark HH	HI-HAT	
323	Light HH	HI-HAT	
324	12" HH	HI-HAT	
325	13" HH	HI-HAT	
326	14" HH	HI-HAT	
327	15" HH	HI-HAT	
328	HandC HH	HI-HAT	
329	Brush1HH	HI-HAT	
330	Brush2HH	HI-HAT	
331	SizzleHH	HI-HAT	
332	TambrnHH	HI-HAT	
333	MaracsHH	HI-HAT	
334	TR808 HH	HI-HAT	
335	TR909 HH	HI-HAT	
336	CR78 HH	HI-HAT	
337	Mt1808HH	HI-HAT	
338	Mt1909HH	HI-HAT	
339	Mt178 HH	HI-HAT	
340	Med16 Cr	CRASH	
341	Med18 Cr	CRASH	
342	Quik16Cr	CRASH	
343	Quik18Cr	CRASH	
344	Dark16Cr	CRASH	
345	Dark18Cr	CRASH	
346	Rock16Cr	CRASH	
347	Rock18Cr	CRASH	
348	Brsh1 Cr	CRASH	
349	Brsh2 Cr	CRASH	
350	SzlBr Cr	CRASH	
351	Swell Cr	CRASH	
352	Splsh 8"	CRASH	
353	Splsh10"	CRASH	
354	Splsh12"	CRASH	
355	HdSpl 8"	CRASH	
356	HdSpl10"	CRASH	
357	DkSpl10"	CRASH	
358	China10"	CRASH	
359	China12"	CRASH	
360	China18"	CRASH	

No.	Inst name	Inst group	Remark
361	China20"	CRASH	
362	SzlChina	CRASH	
363	SwlChina	CRASH	
364	PgyzBack	CRASH	
365	PgyCrsh1	CRASH	
366	PgyCrsh2	CRASH	
367	PgyCrsh3	CRASH	
368	PgyCrsh4	CRASH	
369	PgyCrsh5	CRASH	
370	PgyCrsh6	CRASH	
371	PgSplsh1	CRASH	
372	PgSplsh2	CRASH	
373	PhaseCym	CRASH	
374	Jazz Rd	RIDE	*2
375	Jazz RdB	RIDE	
376	Jazz RdX	RIDE	*2
377	Pop Rd	RIDE	*2
378	Pop RdB	RIDE	
379	Pop RdX	RIDE	*2
380	Rock Rd	RIDE	*2
381	Rock RdB	RIDE	
382	Rock RdX	RIDE	*2
383	Lite Rd	RIDE	*2
384	Lite RdB	RIDE	
385	Lite RdX	RIDE	*2
386	Quick Rd	RIDE	
387	Brsh1 Rd	RIDE	
388	Brsh2 Rd	RIDE	
389	SzlBr Rd	RIDE	
390	Szl1 Rd	RIDE	*2
391	Szl1 RdB	RIDE	
392	Szl1 RdX	RIDE	*2
393	Szl2 Rd	RIDE	*2
394	Szl2 RdB	RIDE	
395	Szl2 RdX	RIDE	*2
396	Szl3 Rd	RIDE	*2
397	Szl3 RdB	RIDE	
398	Szl3 RdX	RIDE	*2
399	Szl4 Rd	RIDE	
400	Pgy Rd1	RIDE	*2
401	Pgy Rd1B	RIDE	
402	Pgy Rd1X	RIDE	*2
403	Pgy Rd2	RIDE	*2
404	Pgy Rd2B	RIDE	
405	Pgy Rd2X	RIDE	*2
406	Cowbell11	PERCUSSION	
407	Cowbell12	PERCUSSION	
408	CowblDuo	PERCUSSION	
409	Tambrn 1	PERCUSSION	
410	Tambrn 2	PERCUSSION	
411	Tambrn 3	PERCUSSION	
412	CongaHMT	PERCUSSION	

## Preset list

No.	Inst name	Inst group	Remark
413	CongaHop	PERCUSSION	
414	CongaHSl	PERCUSSION	
415	CongaMMt	PERCUSSION	
416	CongaMOp	PERCUSSION	
417	CongaMSl	PERCUSSION	
418	CongaLMt	PERCUSSION	
419	CongaLOp	PERCUSSION	
420	CongaLSl	PERCUSSION	
421	BongoHMt	PERCUSSION	
422	BongoHop	PERCUSSION	
423	BongoHSl	PERCUSSION	
424	BongoLMt	PERCUSSION	
425	BongoLOp	PERCUSSION	
426	BongoLSl	PERCUSSION	
427	TimballH	PERCUSSION	
428	TimballL	PERCUSSION	
429	Timbal2H	PERCUSSION	
430	Timbal2L	PERCUSSION	
431	VibraSlp	PERCUSSION	
432	Maracas	PERCUSSION	
433	Shaker	PERCUSSION	
434	Claves	PERCUSSION	
435	CabasUp	PERCUSSION	
436	CabasDwn	PERCUSSION	
437	PandroMt	PERCUSSION	
438	PandroOp	PERCUSSION	
439	PandroSl	PERCUSSION	
440	SurdoHMt	PERCUSSION	
441	SurdoHop	PERCUSSION	
442	SurdoLMt	PERCUSSION	
443	SurdoLOp	PERCUSSION	
444	WhislLng	PERCUSSION	
445	WhislSht	PERCUSSION	
446	Agogo H	PERCUSSION	
447	Agogo L	PERCUSSION	
448	GiroLng1	PERCUSSION	
449	GuiroSht	PERCUSSION	
450	GiroLng2	PERCUSSION	
451	CuicaMt1	PERCUSSION	
452	CuicaOpn	PERCUSSION	
453	CuicaLow	PERCUSSION	
454	CuicaMt2	PERCUSSION	
455	ConcrtBD	PERCUSSION	
456	Timpani	PERCUSSION	
457	TmpHndMt	PERCUSSION	
458	MuteTimp	PERCUSSION	
459	Hand Cym	PERCUSSION	
460	Castanet	PERCUSSION	
461	TringlOp	PERCUSSION	
462	TringlMt	PERCUSSION	
463	WdBlockH	PERCUSSION	
464	WdBlockL	PERCUSSION	

No.	Inst name	Inst group	Remark
465	Sleibell	PERCUSSION	
466	TablaNa	PERCUSSION	
467	TablaTin	PERCUSSION	
468	TablaTun	PERCUSSION	
469	TablaTe	PERCUSSION	
470	TablaTi	PERCUSSION	
471	BayaGe	PERCUSSION	
472	BayaKa	PERCUSSION	
473	BayaGin	PERCUSSION	
474	BayaSl	PERCUSSION	
475	TlkinDrm	PERCUSSION	
476	BellTree	PERCUSSION	
477	BendGong	PERCUSSION	
478	TinyGong	PERCUSSION	
479	Gong	PERCUSSION	
480	TemplBel	PERCUSSION	
481	Taiko	PERCUSSION	
482	Caxixi	PERCUSSION	
483	Kalimba	PERCUSSION	
484	SteelDrm	PERCUSSION	
485	Glcknspl	PERCUSSION	
486	Vibraphn	PERCUSSION	
487	Marimba	PERCUSSION	
488	Xylophon	PERCUSSION	
489	Tublrbel	PERCUSSION	
490	Celesta	PERCUSSION	
491	808Clap	PERCUSSION	
492	808Cwbl1	PERCUSSION	
493	808Cwbl2	PERCUSSION	
494	808Marcs	PERCUSSION	
495	808Clavs	PERCUSSION	
496	808CongH	PERCUSSION	
497	808CongM	PERCUSSION	
498	808CongL	PERCUSSION	
499	78 Cowbl	PERCUSSION	
500	78 Guiro	PERCUSSION	
501	78 Marcs	PERCUSSION	
502	78 MBeat	PERCUSSION	
503	78 Tmbrn	PERCUSSION	
504	AirDrive	OTHER	
505	Burt	OTHER	
506	Biwa	OTHER	
507	Boing1	OTHER	
508	RvsBoin1	OTHER	
509	Boing2	OTHER	
510	RvsBoin2	OTHER	
511	Bounce	OTHER	
512	CarDoor	OTHER	
513	CarHorn	OTHER	
514	Glass	OTHER	
515	Hammer	OTHER	
516	Hi-Q	OTHER	

No.	Inst name	Inst group	Remark
517	MtlNoise	OTHER	
518	MtlPhase	OTHER	
519	Orch Hit	OTHER	
520	OnKey	OTHER	
521	Punch	OTHER	
522	TapeStop	OTHER	
523	RvsTStop	OTHER	
524	TechTamb	OTHER	
525	TechNoiz	OTHER	
526	AfStmp	OTHER	
527	Barrel	OTHER	
528	ChinaDuo	OTHER	
529	Ou!	OTHER	
530	Ou! Up	OTHER	
531	Nope!	OTHER	
532	Snaps	OTHER	
533	Scrach 1	OTHER	
534	Scrach 2	OTHER	
535	Scrach 3	OTHER	
536	Scrach 4	OTHER	
537	Scrach 5	OTHER	
538	Gt Slide	OTHER	
539	RvsGtSld	OTHER	
540	GtScrach	OTHER	
541	RvsGtScr	OTHER	
542	BsSlide	OTHER	
543	RvsBSlId	OTHER	
544	WahGtDwl	OTHER	
545	WahGtUp1	OTHER	
546	WahGtDw2	OTHER	
547	WahGtUp2	OTHER	
548	CutGtDwn	OTHER	
549	CutGtUp	OTHER	
550	Chord 1	OTHER	
551	Chord 2	OTHER	
552	Chord 3	OTHER	
553	BrsFall1	OTHER	
554	BrsFall2	OTHER	
555	BrsFall3	OTHER	
556	BrsFall4	OTHER	
557	TB Bass	OTHER	
558	SlapBass	OTHER	

No.	Inst name	Inst group	Remark
559	SawWave	OTHER	
560	Click	OTHER	
561	Bucket	OTHER	
562	TrashCan	OTHER	
563	Hoo!	OTHER	
564	ElecBird	OTHER	
565	Gun Shot	OTHER	
566	Mystery	OTHER	
567	Monster	OTHER	
568	KnockDwn	OTHER	
569	TimeTrip	OTHER	
570	RvsKick1	OTHER	
571	RvsKick2	OTHER	
572	RvsSnr 1	OTHER	
573	RvsSnr 2	OTHER	
574	RvsAnvil	OTHER	
575	RvsTom	OTHER	
576	RvsCrash	OTHER	
577	RvsChina	OTHER	
578	RvsBelTr	OTHER	
579	Rvs Hi-Q	OTHER	
580	RvsMFaze	OTHER	
581	RvsAirDr	OTHER	
582	Count 1	OTHER	
583	Count 2	OTHER	
584	Count 3	OTHER	
585	Count 4	OTHER	
586	Count 5	OTHER	
587	Count 6	OTHER	
588	Count 7	OTHER	
589	Count 8	OTHER	
590	Count 9	OTHER	
591	Count 10	OTHER	
592	Count 11	OTHER	
593	Count 12	OTHER	
594	Count 13	OTHER	
595	CountAnd	OTHER	
596	Count E	OTHER	
597	Count A	OTHER	
598	Count Ti	OTHER	
599	Count Ta	OTHER	
600	OFF	OTHER	

\*1 Can be played using a "sweep" or "swish" technique (p. 79).

\*2 Responds to positional sensing (p. 36).

\* An "X" at the end of an instrument name means that it is a "cross-faded" type of sound. With velocity, you can control two sounds.

\* When selecting instruments indicated by the following mark "#," a bit more time is needed before you will hear the sound, especially if you are playing constantly while choosing them.

**IMPORTANT:** Please remember that there are limitations regarding instruments and their trigger assignments. Please see page 136.

## ■ Note number (factory settings)

\* For details refer to p. 126.

Percussion group					Drum kit
Note no.	Perc group 1 (General MIDI)	Perc group 2 (Other perc.)	Perc group 3 (Sound effects 1)	Perc group 4 (Sound effects 2)	Preset drum kit 1-50 (Trigger input jack)
	22	OFF	OFF	OFF	7/HI-HAT Rim (Close)
C1	23	Ou!	808Clavs	TB Bass	78 Cowbl
	24	WahGtDw1	808Cwbl1	BsSlide	78 Guiro
	25	WahGtUp1	808Clap	RvsBSlid	78 Marcs
	26	OFF	OFF	OFF	7/HI-HAT Rim (Open)
	27	Hi-Q	ConcrtBD	Gt Slide	78 MBeat
	28	MtlNoise	Roll S	RvsGtSld	78 Tmbrn
	29	WahGtDw2	Timpani	GtScrach	808CongH
	30	WahGtUp2	Timpani	RvsGtScr	808CongM
	31	OFF	OFF	OFF	11/AUX1
	32	OFF	OFF	OFF	11/AUX1 Rim
	33	OFF	OFF	OFF	12/AUX2
	34	OFF	OFF	OFF	12/AUX2 Rim
	35	OFF	OFF	OFF	1/KICK Rim
C2	36	OFF	OFF	OFF	1/KICK
	37	CrsStk 5	CrsStk 4	808Crstk	Click
	38	OFF	OFF	OFF	2/SNARE
	39	OFF	OFF	OFF	6/TOM4 Rim
	40	OFF	OFF	OFF	2/SNARE Rim
	41	OFF	OFF	OFF	6/TOM4
	42	OFF	OFF	OFF	7/HI-HAT (Close)
	43	OFF	OFF	OFF	5/TOM3
	44	OFF	OFF	OFF	7/HI-HAT (Pedal)
	45	OFF	OFF	OFF	4/TOM2
	46	OFF	OFF	OFF	7/HI-HAT (Open)
	47	OFF	OFF	OFF	4/TOM2 Rim
C3	48	OFF	OFF	OFF	3/TOM1
	49	OFF	OFF	OFF	8/CRASH1
	50	OFF	OFF	OFF	3/TOM1 Rim
	51	OFF	OFF	OFF	10/RIDE
	52	OFF	OFF	OFF	9/CRASH2 Rim
	53	OFF	OFF	OFF	10/RIDE Rim
	54	Tambrn 1	Tambrn 3	Tambrn 2	TechTamb
	55	OFF	OFF	OFF	8/CRASH1 Rim
	56	Cowbell11	Cowbell12	808Cwbl2	CowblDuo
	57	OFF	OFF	OFF	9/CRASH2
	58	OFF	OFF	OFF	5/TOM3 Rim
	59	Pop RdX	BongoHMT	AirDrive	Bucket
C4	60	BongoHOp	BongoHOp	Burt	TrashCan
	61	BongoLOp	BongoLOp	Biwa	Hoo!
	62	CongaHMT	CongaHOp	Boing1	ElecBird
	63	CongaHOp	CongaMMt	RvsBoin1	Gun Shot
	64	CongaLOp	CongaMOp	Boing2	Mystery
	65	Timball1H	CongaMS1	RvsBoin2	Monster
	66	Timball1L	CongaLMt	Bounce	KnockDwn
	67	Agogo H	CongaLOp	CarDoor	TimeTrip
	68	Agogo L	CongaLS1	CarHorn	RvsKick1

Percussion group					Drum kit
Note no.	Perc group 1 (General MIDI)	Perc group 2 (Other perc.)	Perc group 3 (Sound effects 1)	Perc group 4 (Sound effects 2)	Preset drum kit 1–50 (Trigger input jack)
69	CabasUp	CabasUp	Glass	RvsSnr 2	
70	Maracas	CabasDwn	Hammer	RvsAnvil	
71	WhislSht	Castanet	MtlNoise	RvsChina	
C5 72	WhislLng	VibraSlp	MtlPhase	RvsBelTr	
73	GuiroSht	GuiroSht	Orch Hit	Rvs Hi-Q	
74	GiroLng1	GiroLng1	OnKey	RvsMFaze	
75	Claves	GiroLng2	Punch	RvsAirDr	
76	WdBlockH	CuicaLow	TapeStop	Count 1	
77	WdBlockL	CuicaOpn	RvsTStop	Count 2	
78	CuicaMt1	CuicaMt1	TechTamb	Count 3	
79	CuicaOpn	CuicaMt2	TechNoiz	Count 4	
80	TringlMt	TablaNa	Barrel	Count 5	
81	TringlOp	TablaTin	Ou!	Count 6	
82	Shaker	TablaTun	Ou! Up	Count 7	
83	Sleibell	TablaTe	Nope!	Count 8	
C6 84	BellTree	BayaGe	BrsFall1	Count 9	
85	Castanet	BayaKa	BrsFall4	Count 10	
86	SurdoLMt	BayaGin	Chord 1	Count 11	
87	SurdoLOp	BayaSl	Chord 2	Count 12	
88	CongaHSl	Kalimba	SlapBass	Count 13	
89	BayaKa	Marimba	TB Bass	CountAnd	
90	BayaGe	BendGong	RvsKick2	Count E	
91	PandroMt	TinyGong	RvsSnr 1	Count A	
92	PandroOp	Gong	RvsTom	Count Ti	
93	PandroSl	TemplBel	RvsCrash	Count Ta	

\* For preset drum kit instruments, note numbers are assigned to each trigger input jack.

\* If the same note number is assigned to both a pad and instrument in a percussion group, the pad has “priority” and you will only hear the sound assigned to that pad.

## ■ Backing inst list

No.	Display	Inst name
1	Ac.Piano	Ac. Piano
2	E.Piano	E.Piano
3	FM+SA EP	FM+SA EP
4	60's EP	60's EP
5	St.FM EP	St.FM EP
6	Br.FM EP	Bright FM EP
7	Clav.	Clav.
8	Celesta	Celesta
9	Glcknspl	Glockenspiel
10	Vibraphn	Vibraphone
11	Marimba	Marimba
12	Xylophon	Xylophone
13	Tublrbel	Tubular-bells
14	Organ 1	Organ 1 (Even Bar)
15	Organ 2	Organ 2
16	Nylon Gt	Nylon Guitar
17	Steel Gt	Steel Guitar
18	Jazz Gt	Jazz Guitar
19	Clean Gt	Clean Guitar
20	ChorusGt	Chorus Guitar
21	Muted Gt	Muted Guitar
22	Pop Gt	Pop Guitar
23	Funk Gt	Funk Guitar
24	OvrdrvGt	Overdrive Guitar
25	Heavy Gt	Heavy Guitar
26	MutDstGt	Muted Distortion Guitar
27	RokRhytm	Rock Rhythm

No.	Display	Inst name
28	Wah Gt	Wah Guitar
29	Aco.Bass	Acoustic Bass
30	El.Ac.Bs	Electric Acoustic Bass
31	FingerBs	Fingered Bass
32	FunkBass	Funk Bass
33	PickBass	Pick Bass
34	MutPikBs	Muted Pick Bass
35	FrtlesBs	Fretless Bass
36	SlapBass	Slap Bass
37	Saw Bass	Saw Bass
38	TB303 Bs	TB303 Bass
39	SH101 Bs	SH101 Bass
40	Syn.Str.	Synth Strings
41	OB Str.	OB Strings
42	Brass 1	Brass 1
43	Brass 2	Brass 2
44	Syn. Brs	Synth Brass
45	Poly Brs	Poly Brass
46	TenorSax	Tenor Sax
47	Flute	Flute
48	Saw Wave	Saw Wave
49	Calliope	Synth Calliope
50	Fantasia	Fantasia
51	ThickPad	Thick Pad
52	80'sPoly	80's Poly Synth
53	Kalimba	Kalimba
54	SteelDrm	Steel Drums



## ■ Preset pattern list

No.	Pattern name	Tempo	Length	Play type
1	Drums	120	6	Loop
2	SlowR	72	4	Loop
3	Sfl'R	120	4	Loop
4	FunkyHR	100	2	Loop
5	SpeedHR	236	4	Loop
6	8bt'R	140	4	Loop
7	16bt'R	112	4	Loop
8	16bt'Bld	75	4	Loop
9	C'Rock	106	12	Loop
10	Blues	55	8	Loop
11	Swing	130	12	Loop
12	BigBand	140	4	Loop
13	JzWaltz	160	4	Loop
14	UKacid	86	4	Loop
15	GngRap	90	4	Loop
16	T Groove	100	4	Loop
17	Funky	105	4	Loop
18	JazzFunk	125	4	Loop
19	S.Soul	154	4	Loop
20	PopShfl	114	8	Loop
21	Fusion	120	12	Loop
22	TechFsn	106	4	Loop
23	Fsn in 5	140	3	Loop
24	N.J.S.	107	4	Loop
25	House	113	4	Loop

No.	Pattern name	Tempo	Length	Play type
26	HipHop	91	4	Loop
27	Techno	140	4	Loop
28	Jungle	170	4	Loop
29	Latin	125	8	Loop
30	Bossa	74	8	Loop
31	Songo	109	4	Loop
32	Samba	110	2	Loop
33	Salsa	108	4	Loop
34	Reggae	132	8	Loop
35	Ska	132	4	Loop
36	PercLoop	120	8	Loop
37	JzIntro	140	3	One Shot
38	JzFnkBrk	125	2	One Shot
39	RockBrk	120	1	One Shot
40	FunkyBrk	105	1	One Shot
41	PercFill	120	1	One Shot
42	DrumFill	240	2	One Shot
43	Kickin16	128	1	One Shot
44	BrsSect	140	2	Tap
45	FunkHit	112	1	Tap
46	PianoRun	120	1	Tap
47	Chord	120	2	Tap
48	BassLine	120	1	Tap
49	PercTap	120	8	Tap
50	SfxTap	60	2	Tap

## Section 1. Receive data

### ■ Channel Voice Messages

\* Following Channel Voice Messages can be recorded in SETUP MIDI TX/RX Channel.

#### ● Note Off

Status	2nd byte	3rd byte
8nH	kkH	vvH
9nH	kkH	00H

n = MIDI channel number: 0H - FH (ch.1 - ch.16)  
kk = note number: 00H - 7FH (0 - 127)  
vv = note off velocity: 00H - 7FH (0 - 127)

- \* In the Drum part, ignored This message.
- \* The Velocity Values of Note Off message are ignored.
- \* When recording, this is recorded in the sequencer data itself.

#### ● Note On

Status	2nd byte	3rd byte
9nH	kkH	vvH

n = MIDI channel number: 0H - FH (ch.1 - ch.16)  
kk = note number: 00H - 7FH (0 - 127)  
vv = note on velocity: 00H - 7FH (0 - 127)

- \* A channel which is assigned to the drum part will receive only the note numbers which are specified by the drum kit or the percussion group.
- \* When recording, this is recorded in the sequencer data itself.

#### ● Polyphonic Key Pressure

Status	2nd byte	3rd byte
AnH	kkH	vvH

n = MIDI channel number: 0H - FH (ch.1 - ch.16)  
kk = note number: 00H - 7FH (0 - 127)  
vv = Value: 00H - 7FH (0 - 127) Initial value = 00H (0)

- \* A channel which is assigned to the drum part will receive only the note numbers which are specified by the drum kit.
- \* If the value is greater than 40H (64), the decay of the note sounded by the received note number will be shortened.
- \* Not recorded in the sequencer.

#### ● Control Change

##### ○ Modulation (Controller number 1)

Status	2nd byte	3rd byte
BnH	01H	vvH

n = MIDI channel number: 0H - FH (ch.1 - ch.16)  
vv = Modulation depth: 00H - 7FH (0 - 127) Initial value = 00H (0)

- \* Only the channel assigned to the drum part can be received.
- \* If the SETUP MIDI CTRL settings Pedal CC or Zone CC are set to MODULATION, the effect will apply to the specified parameter.
- \* During recording, this will be recorded in the sequencer data as Pedal Ctrl Chg data or Zone Ctrl Chg data.

##### ○ Foot Control (Controller number 4)

Status	2nd byte	3rd byte
BnH	04H	vvH

n = MIDI channel number: 0H - FH (ch.1 - ch.16)  
vv = Control value: 00H - 7FH (0 - 127) Initial value = 00H (0)

- \* Only the channel assigned to the drum part can be received.
- \* The effect will be obtained when SETUP MIDI CTRL Pedal CC is set to FOOT CONTROL.
- \* When recording, this will be recorded as Pedal Ctrl Chg data in the sequencer data itself.

##### ○ Data Entry MSB (Controller number 6)

Status	2nd byte	3rd byte
BnH	06H	mmH

n = MIDI channel number: 0H - FH (ch.1 - ch.16)  
mm = Control value: 00H - 18H (0 - 24semitone) Initial value = 02H (2 semitone)

- \* If RPN was previously specified as 00H 00H (Pitch Bend Sensitivity), you can specify the pitch bend sensitivity. This can be specified in semitone steps up to a maximum of 2 octaves. (Refer to the RPN item.)
- \* In the Drum part, ignored This message.
- \* Not recorded in the sequencer.

##### ○ Volume (Controller number 7)

Status	2nd byte	3rd byte
BnH	07H	vvH

n = MIDI channel number: 0H - FH (ch.1 - ch.16)  
vv = Volume: 00H - 7FH (0 - 127)

- \* Volume messages are used to adjust the volume balance of each track.
- \* Not recorded in the sequencer.

##### ○ Pan (Controller number 10)

Status	2nd byte	3rd byte
BnH	0AH	vvH

n = MIDI channel number: 0H - FH (ch.1 - ch.16)  
vv = pan: 00H - 40H - 7FH (Left - Center - Right)

- \* In the Drum part, ignored This message.
- \* Not recorded in the sequencer.

##### ○ General purpose controller 1 (Controller number 16)

Status	2nd byte	3rd byte
BnH	10H	vvH

n = MIDI channel number: 0H - FH (ch.1 - ch.16)  
vv = Control value: 00H - 7FH (0 - 127) Initial value = 00H (0)

- \* Only the channel assigned to the drum part can be received.
- \* If the SETUP MIDI CTRL settings Pedal CC or Zone CC are set to General Purpose Controller 1, the effect will apply to the specified parameter.
- \* During recording, this will be recorded in the sequencer data as Pedal Ctrl Chg data or Zone Ctrl Chg data.

##### ○ General purpose controller 2 (Controller number 17)

Status	2nd byte	3rd byte
BnH	10H	vvH

n = MIDI channel number: 0H - FH (ch.1 - ch.16)  
vv = Control value: 00H - 7FH (0 - 127) Initial value = 00H (0)

- \* Only the channel assigned to the drum part can be received.
- \* If the SETUP MIDI CTRL settings Pedal CC or Zone CC are set to General Purpose Controller 2, the effect will apply to the specified parameter.
- \* During recording, this will be recorded in the sequencer data as Pedal Ctrl Chg data or Zone Ctrl Chg data.

##### ○ Hold 1 (Controller number 64)

Status	2nd byte	3rd byte
BnH	40H	vvH

n = MIDI channel number: 0H - FH (ch.1 - ch.16)  
vv = Control value: 00H - 7FH (0 - 127) 0-63 = OFF, 64-127 = ON

- \* In the Drum part, ignored This message.
- \* When recording, this is recorded in the sequencer data itself.

○ RPN MSB/LSB (Controller number 100, 101)

Status	2nd byte	3rd byte
BnH	65H	mmH
BnH	64H	llH

n = MIDI channel number: 0H - FH (ch.1 - ch.16)  
 mm = upper byte of parameter number specified by RPN  
 ll = lower byte of parameter number specified by RPN

- \* In the Drum part, ignored This message.
- \* The value specified by RPN will not be reset even by messages such as Program Change or Reset All Controller.
- \* Not recorded in the sequencer.

RPN	Data	entry
MSB LSB	MSB LSB	Explanation
00H 00H	mmH	Pitch Bend Sensitivity mm: 00H - 18H (0 - 24 semitones) Initial Value = 02H (2 semitones) ll: ignored (processed as 00H) specify up to 2 octaves in semitone steps
7FH 7FH	---	RPN null set condition where RPN and NRPN are unspecified. The data entry messages after set RPN null will be ignored. (No Data entry messages are required after RPN null). Settings already made will not change. mm,ll: ignored

● Program Change

Status	2nd byte
CnH	ppH

1. Drum Part

n = MIDI channel number: 0H - FH (ch.1 - ch.16)  
 pp = Program number: 00H - 7FH (prog.1 - prog.128)

2. Part 1, Part 2, Bass Part

n = MIDI channel number: 0H - FH (ch.1 - ch.16)  
 pp = Program number: 00H - 35H (prog.1 - prog.54)

- \* The sound will change beginning with the next note-on after the program change is received. Voices which were already sounding before the program change was received will not be affected.
- \* Not recorded in the sequencer.

● Pitch Bend Change

Status	2nd byte	3rd byte
EnH	llH	mmH

n = MIDI channel number: 0H - FH (ch.1 - ch.16)  
 mm,ll = Pitch Bend value: 00 00H - 40 00H - 7F 7FH (-8192 - 0 - +8191)  
 Initial value = 40H 00H (Center)

- \* When recording, this is recorded in the sequencer data itself.

■ Channel Mode Messages

● All Sounds Off (Controller number 120)

Status	2nd byte	3rd byte
BnH	78H	00H

n = MIDI channel number: 0H - FH (ch.1 - ch.16)

- \* When this message is received, all currently-sounding notes on the corresponding channel will be silenced. However, the status of channel messages will not change.
- \* When recording, this is recorded in the sequencer data itself.

● Reset All Controllers (Controller number 121)

Status	2nd byte	3rd byte
BnH	79H	00H

n = MIDI channel number: 0H - FH (ch.1 - ch.16)

- \* When this message is received, the following controllers will be set to their reset values. When recording, a control message carrying the reset value will be created and recorded.

Controller	Reset value
Pitch Bend Change	+/-0 (center)
Modulation	0 (off)(When set to Ctr Chg.)
Foot Control	0 (off)(When set to Ctr Chg.)
General Purpose Controller 1	0 (off)(When set to Ctr Chg.)
General Purpose Controller 2	0 (off)(When set to Ctr Chg.)
Hold 1	0 (off)
RPN	unset; previously set data will not change

● All Notes Off (Controller number 123)

Status	2nd byte	3rd byte
BnH	7BH	00H

n = MIDI channel number: 0H - FH (ch.1 - ch.16)

- \* When All Notes Off is received, all notes on the corresponding channel will be turned off. However if Hold 1 is ON, the sound will be continued until these are turned off.
- \* In the recording mode, "Note OFF message" will be created for corresponding Note ON message, and will be recorded.

● OMNI OFF (Controller number 124)

Status	2nd byte	3rd byte
BnH	7CH	00H

n = MIDI channel number: 0H - FH (ch.1 - ch.16)

- \* The same processing will be carried out as when All Notes Off is received.

● I OMNI ON (Controller number 125)

Status	2nd byte	3rd byte
BnH	7DH	00H

n = MIDI channel number: 0H - FH (ch.1 - ch.16)

- \* OMNI ON is only recognized as "All notes off".

● MONO (Controller number 126)

Status	2nd byte	3rd byte
BnH	7EH	mmH

n = MIDI channel number: 0H - FH (ch.1 - ch.16)  
 mm = mono number: 00H - 10H (0 - 16)

- \* The same processing will be carried out as when All Sound Off or All Notes Off is received.

● POLY (Controller number 127)

Status	2nd byte	3rd byte
BnH	7FH	00H

n = MIDI channel number: 0H - FH (ch.1 - ch.16)

- \* The same processing will be carried out as when All Sound Off or All Notes Off is received.

■ System Common Messages

● Song Select

Status	2nd byte
F3H	ppH

pp = Pattern Number: 00H-63H (PATTERN01-PATTERN100)

- \* Reception does not take place when the Sync Mode for PATTERN GLOBAL is set to Internal or MIDI → Delay.
- \* This is recognized only in Pattern Play when playback is stopped.
- \* Not recorded in the sequencer.

# MIDI implementation

## ■ System Realtime Message

\* Following System Realtime Messages cannot be recorded in recording mode.

### ● Timing Clock

Status  
F8H

\* Recognized only when the "Sync Mode" of the Pattern Global is set at "AUTO", "EXT" or "MIDI → DELAY".

### ● Start

Status  
FAH

\* Recognized only when the "Sync Mode" of the Pattern Global is set at "AUTO", "EXT" or REMOTE.

### ● Continue

Status  
FBH

\* Recognized only when the "Sync Mode" of the Pattern Global is set at "AUTO", "EXT" or REMOTE.

### ● Stop

Status  
FCH

\* Recognized only when the "Sync Mode" of the Pattern Global is set at "AUTO", "EXT" or REMOTE.

### ● Active Sensing

Status  
FEH

\* When Active Sensing is received, the unit will begin monitoring the intervals of all further messages. While monitoring, if the interval between messages exceeds about 420 ms, the same processing will be carried out as when All Sounds Off, All Notes Off and Reset All Controllers are received, and message interval monitoring will be halted.

## ■ System Exclusive Message

\* Following System Exclusive Messages cannot be recorded.

<u>Status</u>	<u>Data byte</u>	<u>Status</u>
F0H	iiH, ddH, .....eeH	F7H

F0H: System Exclusive Message status  
 ii = ID number: an ID number (manufacturer ID) to indicate the manufacturer whose Exclusive message this is. Roland's manufacturer ID is 41H. ID numbers 7EH and 7FH are extensions of the MIDI standard; Universal Non-realtime Messages (7EH) and Universal Realtime Messages (7FH).  
 dd,.....ee = data: 00H - 7FH (0 - 127)  
 F7H: EOX (End Of Exclusive)

The System Exclusive Messages received by the TD-10 are; Universal Non-realtime System Exclusive Messages, Data Requests (RQ1), and Data Set (DT1).

### ● Universal Non-realtime System Exclusive Messages

#### ○ Inquiry request

<u>Status</u>	<u>Data byte</u>	<u>Status</u>
F0H	7EH, dev, 06H, 01H	F7H

<u>Byte</u>	<u>Explanation</u>
F0H	Exclusive status
7EH	ID number (universal non-realtime message)
dev	Device ID (dev: 00H - 1FH (1 - 32) Initial value is 10H (17))
06H,01H	Inquiry request
F7H	EOX (End Of Exclusive)

\* Even if the Device ID is 7FH (Broadcast), Inquiry Reply message will be transmitted.  
 \* When Inquiry Request is received, Inquiry Reply message will be transmitted.

### ● Data transmission

TD-10 can transmit and receive the various parameters using System Exclusive messages. The exclusive message of TD-10's data has a model ID of 00H 0AH and a device ID of 10H (17). Device ID can be changed in TD-10.

#### ○ Request data 1 RQ1 (11H)

This message requests the other device to send data. The Address and Size determine the type and amount of data to be sent.

When a Data Request message is received, if the device is ready to transmit data and if the address and size are appropriate, the requested data will be transmitted as a "Data Set 1 (DT1)" message. If not, nothing will be transmitted.

<u>Status</u>	<u>Data byte</u>	<u>Status</u>
F0H	41H, dev, 00H, 0AH, 11H, aaH, bbH, ccH, ddH, ssH, ttH, uuH, vvH, sum	F7H

<u>Byte</u>	<u>Explanation</u>
F0H	Exclusive status
41H	ID number (Roland)
dev	Device ID (dev: 00H - 1FH Initial value is 10H (17))
00H 0AH	Model ID (TD-10)
11H	Command ID (RQ1)
aaH	Address MSB: upper byte of the starting address of the requested data
bbH	Address 2nd : 2nd byte of the starting address of the requested data
ccH	Address 3rd : 3rd byte of the starting address of the requested data
ddH	Address LSB: lower byte of the starting address of the requested data
ssH	Size MSB
ttH	Size 2nd
uuH	Size 3rd
uuH	Size LSB
sum	Checksum
F7H	EOX (End Of Exclusive)

\* The amount of data that can be transmitted at once time will depend on the type of data, and data must be requested using a specific starting address and size. Refer to the Address and Size listed in Parameter Dump Request (Page 158).

\* Regarding the checksum please refer to Page 163.

#### ○ Data set 1 DT1 (12H)

This is the message that actually performs data transmission, and is used when you wish to transmit the data.

<u>Status</u>	<u>Data byte</u>	<u>Status</u>
F0H	41H, dev, 00H, 0AH, 12H, aaH, bbH, ccH, ddH, eeh,... ffH, sum	F7H

<u>Byte</u>	<u>Explanation</u>
F0H	Exclusive status
41H	ID number (Roland)
dev	Device ID (dev: 00H - 1FH Initial value is 10H))
00H	0AH Model ID (TD-10)
12H	Command ID (DT1)
aaH	Address MSB: upper byte of the starting address of the transmitted data
bbH	Address 2nd : 2nd byte of the starting address of the transmitted data
ccH	Address 3rd: 3rd byte of the starting address of the transmitted data
ddH	Address LSB: lower byte of the starting address of the transmitted data
eeH	Data: the actual data to be transmitted. Multiple bytes of data are transmitted starting from the address.
:	:
ffH	Data
sum	Checksum
F7H	EOX (End Of Exclusive)

\* The amount of data that can be transmitted at once time will depend on the type of data, and data must be requested using a specific starting address and size. Refer to the Address and Size listed in Parameter Dump Request (Page 158).

\* If "Data Set 1" is transmitted successively, there must be an interval of at least 45 ms.

\* Regarding the checksum please refer to Page 163.

## Section 2. Transmit data

### ■ Channel Voice Messages

\* The following channel voice messages are transmitted on the channel specified as the SETUP MIDI TX/RX Channel.

#### ● Note off

Status	2nd byte	3rd byte
8nH	kkH	vvH

n = MIDI channel number: 0H - FH (ch.1 - ch.16)  
 kk = note number: 00H - 7FH (0 - 127)  
 vv = Note off velocity: 40H (64) fixed

#### ● Note on

Status	2nd byte	3rd byte
9nH	kkH	vvH

n = MIDI channel number: 0H - FH (ch.1 - ch.16)  
 kk = note number: 00H - 7FH (0 - 127)  
 vv = note on velocity: 01H - 7FH (1 - 127)

\* On the channel assigned to the drum part, the note numbers specified by the drum kit or the percussion group will be transmitted.

#### ● Polyphonic key pressure

Status	2nd byte	3rd byte
AnH	kkH	vvH

n = MIDI channel number: 0H - FH (ch.1 - ch.16)  
 kk = note number: 00H - 7FH (0 - 127)  
 vv = value: 00H, 7FH (0, 127) Initial value = 00H (0)

\* On the channel assigned to the drum part, 7FH will be transmitted when the rim of the pad is pressed and 00H when the rim is released, for the note number specified for the pad and rim.

#### ● Control Change

##### ○ Modulation (Controller number 1)

Status	2nd byte	3rd byte
BnH	01H	vvH

n = MIDI channel number: 0H - FH (ch.1 - ch.16)  
 vv = Modulation depth: 00H - 7FH (0 - 127) Initial value = 00H (0)

\* This is transmitted only on the channel which is assigned to the drum part.  
 \* If the SETUP MIDI CTRL settings Pedal CC or Zone CC are set to MODULATION, the specified parameter will be transmitted.

##### ○ Foot control (Controller number 4)

Status	2nd byte	3rd byte
BnH	04H	vvH

n = MIDI channel number: 0H - FH (ch.1 - ch.16)  
 vv = Control value: 00H - 7FH (0 - 127) Initial value = 00H (0)

\* This is transmitted only on the channel which is assigned to the drum part.  
 \* This will be transmitted if the SETUP MIDI CTRL setting Pedal CC is set to FOOT CONTROL.

##### ○ Data entry MSB

Status	2nd byte	3rd byte
BnH	06H	vvH

n = MIDI channel number: 0H - FH (ch.1 - ch.16)  
 vv = Control value: 00H - 7FH (0 - 127)

\* When a pattern is selected, the sequencer's pitch bend sensitivity value will be transmitted.

##### ○ Volume (Controller number 7)

Status	2nd byte	3rd byte
BnH	07H	vvH

n = MIDI channel number: 0H - FH (ch.1 - ch.16)  
 vv = Volume: 00H - 7FH (0 - 127)

\* When a pattern is selected, the Part Level of the sequencer pattern data will be transmitted.

##### ○ Pan (Controller number 10)

Status	2nd byte	3rd byte
BnH	0AH	vvH

n = MIDI channel number: 0H - FH (ch.1 - ch.16)  
 vv = pan: 00H - 40H - 7FH (Left - Center - Right)

\* When a pattern is selected, the Pan of the sequencer pattern data will be transmitted.

##### ○ General purpose controller 1 (Controller number 16)

Status	2nd byte	3rd byte
BnH	10H	vvH

n = MIDI channel number: 0H - FH (ch.1 - ch.16)  
 vv = Control value: 00H - 7FH (0 - 127) Initial value = 00H (0)

\* This is transmitted only on the channel which is assigned to the drum part.  
 \* This will be transmitted if the SETUP MIDI CTRL settings Pedal CC or Zone CC are set to General Purpose Controller 1.

##### ○ General purpose controller 2 (Controller number 17)

Status	2nd byte	3rd byte
BnH	11H	vvH

n = MIDI channel number: 0H - FH (ch.1 - ch.16)  
 vv = Control value: 00H - 7FH (0 - 127) Initial value = 00H (0)

\* This is transmitted only on the channel which is assigned to the drum part.  
 \* This will be transmitted if the SETUP MIDI CTRL settings Pedal CC or Zone CC are set to General Purpose Controller 2.

##### ○ Hold 1 (Controller number 64)

Status	2nd byte	3rd byte
BnH	40H	vvH

n = MIDI channel number: 0H - FH (ch.1 - ch.16)  
 vv = Control value: 00H - 7FH (0 - 127) 0-63 = OFF 64-127 = ON

\* Transmitted only when the TD-10 is in play for Pattern in which Hold 1 is recorded.

##### ○ RPN MSB/LSB (Controller number 100,101)

Status	2nd byte	3rd byte
BnH	65H	mmH
BnH	64H	llH

n = MIDI channel number: 0H - FH (ch.1 - ch.16)  
 mm = upper byte of parameter number specified by RPN  
 ll = lower byte of parameter number specified by RPN

\* When a pattern is selected, the sequencer's pitch bend sensitivity value will be transmitted.

RPN	Data	entry
<u>MSB LSB</u>	<u>MSB LSB</u>	<u>Explanation</u>
00H 00H	mmH —	Pitch Bend Sensitivity mm: 00H - 18H (0 - 24 semitones) Initial Value = 02H (2 semitones) ll: ignored (processed as 00H) specify up to 2 octaves in semitone steps
7FH 7FH	— —	RPN null set condition where RPN and NRPN are unspecified. The data entry messages after set RPN null will be ignored. (No Data entry messages are required after RPN null). Settings already made will not change. mm,ll: ignored

# MIDI implementation

## ● Program Change

Status      2nd byte  
CnH          ppH

n = MIDI channel number:    0H - FH (ch.1 - ch.16)  
pp = Program number:        00H - 7FH (prog.1 - prog.128)

\* When a drum kit is selected, or when a pattern is selected, the pattern number of the sequencer pattern data will be transmitted.

## ● Pitch Bend Change

Status      2nd byte      3rd byte  
EnH          llH            mmH

n = MIDI channel number:    0H - FH (ch.1 - ch.16)  
mm,ll = Pitch Bend value:    00 00H - 40 00H - 7F 7FH (-8192 - 0 - +8191)

\* Transmitted only when the TD-10 is in play for Pattern in which Pitch Bend Change is recorded.

## ■ System Common Messages

### ● Song Position Pointer

Status      2nd byte      3rd byte  
F2H          llH            mmH

mm,ll = Song Position:        F00 00H - 7F 7FH(0 - 16383)

### ● Song Select

Status      2nd byte  
F3H          ppH

pp = Pattern number:        00H-63H (PATTERN1-PATTERN100)

\* When a pattern is selected, the song select number will be transmitted.

## ■ System Realtime Message

### ● Timing Clock

Status  
F8H

### ● Start

Status  
FAH

### ● Continue

Status  
FBH

### ● Stop

Status  
FCH

### ● Active sensing

Status  
FEH

\* This will be transmitted constantly at intervals of approximately 250ms.

## ■ System exclusive messages

Inquiry reply and Data Set 1 (DT1) are the only System Exclusive messages transmitted by TD-10.

When an appropriate "Inquiry Request" or "Data Request 1 (RQ1)" message is received, the requested internal data will be transmitted.

## ● Universal Non-realtime System Exclusive Messages

### ○ Inquiry reply

<u>Status</u>	<u>Data byte</u>	<u>Status</u>
F0H	7EH, dev, 06H, 02H, 41H, 0AH, 01H, 00H, 00H, 00H,	F7H
	06H, 00H, 00H	

<u>Byte</u>	<u>Explanation</u>
F0H	Exclusive status
7EH	ID number (universal non-realtime message)
dev	Device ID (dev: 00H - 1FH (1 - 32) Initial value is 10H (17))
06H 02H	Inquiry reply
41H	ID number(Roland)
0AH 01H	Device family code
00H 00H	Device family number code
00H 02H 00H 00H	software revision level
F7H	EOX (End Of Exclusive)

\* When Inquiry Request (P. 156) is received, Inquiry Reply message will be transmitted.

### ○ Data set 1                      DT1 (12H)

<u>Status</u>	<u>Data byte</u>	<u>Status</u>
F0H	41H, dev, 00H, 0AH, 12H, aaH, bbH, ccH, ddH, eeH,... ffH, sum	F7H

<u>Byte</u>	<u>Explanation</u>
F0H	Exclusive status
41H	ID number (Roland)
dev	Device ID (dev: 00H - 1FH Initial value is 10H)
00H 0AH	Model ID (TD-10)
12H	Command ID (DT1)
aaH	Address MSB: upper byte of the starting address of the data to be sent
bbH	Address 2nd: 2nd byte of the starting address of the data to be sent
ccH	Address 3rd: 3rd byte of the starting address of the data to be sent.
ddH	Address LSB: lower byte of the starting address of the data to be sent.
eeH	Data: the actual data to be sent. Multiple bytes of data are transmitted in order starting from the address.
:	:
ffH	Data
sum	Checksum
F7H	EOX (End Of Exclusive)

\* The amount of data that can be transmitted at once time will depend on the type of data, and data must be requested using a specific starting address and size. Refer to the Address and Size listed in 3.Parameter address map (Page 159).

\* Data larger than 128 bytes must be divided into packets of 128 bytes or less. If "Data Set 1" is transmitted successively, there must be an interval of at least 40 ms between packets.

\* Regarding the checksum please refer to Page 163.

## ■ Bulk Dump

Bulk Dump allows you to transmit a large amount of data at once, and is convenient for storing settings for the entire unit on a computer or sequencer.

For Bulk Dump Request, you must use the Address and Size listed in the following "Bulk Dump Request."

### ● Bulk Dump Request

<u>Address(H)</u>	<u>Size(H)</u>
10 00 00 00	00 00 00 00 (ALL Patterns: dump request for all user pattern (51-100))
40 00 00 00	01 00 00 00 (SETUP:)
41 nn 00 00	00 01 00 00 (DRUM KIT:)
44 pp 16 00	00 00 48 00 (PERCUSSION GROUP:)

mm = 01-32H (Pattern No.51-100)

nn = 00-31H (Drum Kit No.1-50)

pp = 00-03H (Perc Group No.1-4)

\* Request for ALL PATTERNS and SET UP are correspond to "Bulk Dump" parameter ([SETUP]-[F2(MIDI)]-[F4(BULK)]).

\* Data of preset pattern (No.1-50) cannot be transmitted.

### 3. Parameter address map

#### (Model ID = 00H 0AH)

This map indicates address, size, Data (range), Parameter, and Description of parameters which can be transferred using "Data set 1 (DT1)".

All the numbers of address, size, Data, and Default Value are indicated in 7-bit Hexadecimal-form.

Addresses marked at "#" cannot be used as starting addresses.

#### ■ Parameter Address Block

##### TD-10 (Model ID = 00H 0AH)

Start address	Description		
00 00 00 00	SETUP	(Individual)	*1-1
01 00 00 00	DRUM KIT 1	(Individual)	*1-2
: 01 31 00 00	DRUM KIT 50	(Individual)	*1-2
04 00 00 00	PERCUSSION GROUP 1	(Individual)	*1-3
: 04 03 00 00	PERCUSSION GROUP 4	(Individual)	*1-3
10 00 00 00	PATTERN	(Bulk)	*1-4
40 00 00 00	SETUP	(Bulk)	*1-1
41 00 00 00	DRUM KIT 1	(Bulk)	*1-2
: 41 31 00 00	DRUM KIT 50	(Bulk)	*1-2
44 00 00 00	PERCUSSION GROUP 1	(Bulk)	*1-3
: 44 03 00 00	PERCUSSION GROUP 4	(Bulk)	*1-3

##### \* 1-1 SETUP

Offset address	Description		
00 00 00	TRIGGER BANK 1		*1-1-1
: 00 30 00	TRIGGER BANK 4		*1-1-1
01 00 00	DRUM KIT CHAIN 1 (Name)		*1-1-2
: 01 0F 00	DRUM KIT CHAIN 16 (Name)		*1-1-2
02 00 00	DRUM KIT CHAIN 1 (Step)		*1-1-3
: 02 0F 00	DRUM KIT CHAIN 16 (Step)		*1-1-3
03 00 00	MIDI		*1-1-4
04 00 00	PROGRAM CHANGE MAP		*1-1-5
05 00 00	CONTROL		*1-1-6
06 00 00	MASTER EQ		*1-1-7
07 00 00	MASTER TUNE		*1-1-8

##### \* 1-1-1 TRIGGER BANK

Offset address	Description		
00 00	Pad parameters (1/KICK)		*1-1-1-1
: 0B 00	Pad parameters (12/AUX2)		*1-1-1-1

##### \* 1-1-1-1 TRIGGER BANK (Pad parameters)

Offset address	Description		
00	0000 aaaa	Trigger Type	0 - 15 (PD5,PD7,PD9,10A,10B,12A,12B,P 1,P 2, KD7,K 1,K 2,KIK,SNR,TOM,FLR)
01	0000 0aaa	Head Tension Adjustment	0 - 1 (Loose,Normal,Tight) (2/SNARE only)
02	000a aaaa	Rim Sensitivity	0 - 15 (OFF, 1 - 15) (2/SNARE only)
03	0000 aaaa	STICK	Sensitivity
04	0000 aaaa	STICK	Threshold
05	0000 0aaa	STICK	Sens Curve
			(Linear,EXP1,EXP2,LOG1,LOG2,Spline, Loud1,Loud2)
06	00aa aaaa	STICK	Scan Time
			(0.0ms - 4.0ms, 0.1ms step)
07	0000 aaaa	STICK	Retrigger Cancel
			(1 - 16)

08	000a aaaa	STICK	Mask Time	0 - 16 (0ms - 64ms, 4ms step)
09	0000 0aaa	STICK	Crosstalk	0 - 6 (OFF,30,40,50,60,70,80)
0A	0000 aaaa	BRUSH	Sensitivity	0 - 15 (1 - 16)
0B	0000 aaaa	BRUSH	Threshold	0 - 15
0C	0000 0aaa	BRUSH	Sens Curve	0 - 7 (Linear,EXP1,EXP2,LOG1,LOG2,Spline, Loud1,Loud2)
0D	00aa aaaa	BRUSH	Scan Time	0 - 40 (0.0ms - 4.0ms, 0.1ms step)
0E	0000 aaaa	BRUSH	Retrigger Cancel	0 - 15 (1 - 16)
0F	000a aaaa	BRUSH	Mask Time	0 - 16 (0ms - 64ms, 4ms step)
10	0000 0aaa	BRUSH	Crosstalk	0 - 6 (OFF,30,40,50,60,70,80)
Total size	00 00 00 11			

##### \* 1-1-2 DRUM KIT CHAIN (Name)

Offset address	Description		
# 00	0aaa aaaa	Drum Kit CHAIN Name	32 - 127
: # 01	0aaa aaaa	Drum Kit CHAIN Name	32 - 127
: # 07	0aaa aaaa	Drum Kit CHAIN Name	32 - 127
Total size	00 00 00 08		

##### \* 1-1-3 DRUM KIT CHAIN (Step)

Offset address	Description		
00	0aaa aaaa	Drum Kit Number (Step1)	0 - 50 (1-50, END)
# 01	0aaa aaaa	Drum Kit Number (Step2)	0 - 50 (1-50, END)
: # 1F	0aaa aaaa	Drum Kit Number (Step32)	0 - 50 (1-50, END)
Total size	00 00 00 20		

##### \* 1-1-4 MIDI

Offset address	Description		
00 00	000a aaaa	MIDI Channel (DRUM)	0 - 16 (1 - 16,OFF)
00 01	000a aaaa	MIDI Channel (PART1)	0 - 16 (1 - 16,OFF)
00 02	000a aaaa	MIDI Channel (PART2)	0 - 16 (1 - 16,OFF)
00 03	000a aaaa	MIDI Channel (BASS)	0 - 16 (1 - 16,OFF)
00 04	0000 00aa	Zone CC (2/SNARE)	0 - 3 (OFF,Modulation(1),General1(16), GENERAL2(17))
00 05	0000 00aa	Zone CC (10/RIDE)	0 - 3 (OFF,Modulation(1),General1(16), General2(17))
00 06	0000 0aaa	Pedal CC	0 - 4 (OFF,Modulation(1),Foot Ctrl(4), General1(16),General2(17))
00 07	0000 000a	Program Change Rx SW	0 - 1 (OFF,ON)
00 08	0000 000a	Program Change Tx SW	0 - 1 (OFF,ON)
00 09	0000 000a	Local Control	0 - 1 (OFF,ON)
00 0A	0000 000a	Soft Through	0 - 1 (OFF,ON)
00 0B	0000 000a	Note Chase	0 - 1 (OFF,ON)
00 0C	0000 00aa	Pedal Data Thin	0 - 2 (OFF,1,2)
Total size	00 00 00 0D		

##### \* 1-1-5 PROGRAM CHANGE MAP

Offset address	Description		
00 00	0aaa aaaa	Program Change (DRUM KIT 1)	0 - 127 (1 - 128)
: 00 31	0aaa aaaa	Program Change (DRUM KIT 50)	0 - 127 (1 - 128)
Total size	00 00 00 32		

# MIDI implementation

## \* 1-1-6 CONTROL

Offset address	Description		
00 00	0000 00aa	Foot SW Mode	0 - 2 (*1)
00 01	0000 0aaa	Pad SW Mode	0 - 4 (*2)
00 02	0000 aaaa	Display Contrast	0 - 15 (1 - 16)
00 03	0000 000a	Mix In Output	0 - 1 (Master, Phones Only)
00 04	0000 000a	Preview Dynamics	0 - 1 (OFF, ON)
00 05	0aaa aaaa	Preview Velocity	1 - 127
Total size	00 00 00 06		

### (\*1) Foot SW Mode

	[ SW1 ]	[ SW2 ]
0 KIT SELECT	KIT# DEC	KIT# INC
1 PATTERN SEL	PTN# DEC	PTN# INC
2 PATTERN PLAY	PTN# INC	STOP/PLAY

### (\*2) Pad SW Mode

	[ AUX1 ]	[ AUX2 ]
0 OFF	OFF	OFF
1 KIT SELECT	OFF	KIT# INC
2 PATTERN SEL	OFF	PTN# INC
3 KIT SELECT(2)	KIT# DEC	KIT# INC
4 PATTERN SEL(2)	PTN# DEC	PTN# INC

## \* 1-1-7 MASTER EQ

Offset address	Description		
00 00	0000 aaaa	Low Frequency	0 - 14 (20Hz - 500Hz)
00 01	0aaa aaaa	Low Gain	49 - 79 (-15db - +15db)
00 02	000a aaaa	Mid Frequency	7 - 23 (100Hz - 4kHz)
00 03	0aaa aaaa	Mid Gain	49 - 79 (-15db - +15db)
00 04	000a aaaa	Mid Q	0 - 20 (0.5, 1.0 - 20.0, 1.0step)
00 05	000a aaaa	High Frequency	14 - 30 (500Hz - 20kHz)
00 06	0aaa aaaa	High Gain	49 - 79 (-15db - +15db)
00 07	0000 000a	SW	0 - 1 (OFF, ON)
Total size	00 00 00 08		

## \* 1-1-8 MASTER TUNE

Offset address	Description		
00 00	0000 aaaa	Master Tune	0 - 509 (415.3 - 466.2Hz)
# 01	0000 bbbb		
# 02	0000 cccc		
# 03	0000 dddd		
Total size	00 00 00 04		

## \* 1-2 DRUM KIT

Offset address	Description		
00 00	Common parameters		*1-2-1
01 00	Pad parameters (1/KICK)		*1-2-2
02 00	Pad parameters (2/SNARE)		*1-2-2
03 00	Pad parameters (3/TOM1)		*1-2-2
04 00	Pad parameters (4/TOM2)		*1-2-2
05 00	Pad parameters (5/TOM3)		*1-2-2
06 00	Pad parameters (6/TOM4)		*1-2-2
07 00	Pad parameters (7/HIHAT)		*1-2-2
08 00	Pad parameters (8/CRASH1)		*1-2-2
09 00	Pad parameters (9/CRASH2)		*1-2-2
0A 00	Pad parameters (10/RIDE)		*1-2-2
0B 00	Pad parameters (11/AUX1)		*1-2-2
0C 00	Pad parameters (12/AUX2)		*1-2-2

## \* 1-2-1 DRUM KIT (Common parameters)

Offset address	Description		
00 00 00	0aaa aaaa	Drum Kit Name 1	32 - 127
00 00 01	0aaa aaaa	Drum Kit Name 2	32 - 127
# 00 00 07	0aaa aaaa	Drum Kit Name 8	32 - 127
00 00 08	0000 00aa	PERCUSSION GROUP Assign	0 - 3 (1 - 4)

00 00 09	0000 0000	dummy (ingnored)	
00 00 0A	0aaa aaaa	GROUP VOLUME (DRUMS)	0 - 127
00 00 0B	0aaa aaaa	GROUP VOLUME (PERC)	0 - 127
00 00 0C	0aaa aaaa	AMBIENCE Group Send Level (DRUMS)	0 - 127
00 00 0D	0aaa aaaa	AMBIENCE Group Send Level (PERC)	0 - 127
00 00 0E	0aaa aaaa	AMBIENCE Group Send Level (PART)	0 - 127
00 00 0F	0aaa aaaa	EFFECT Group Send Level (DRUMS)	0 - 127
00 00 10	0aaa aaaa	EFFECT Group Send Level (PERC)	0 - 127
00 00 11	0aaa aaaa	EFFECT Group Send Level (PART)	0 - 127
00 00 12	0aaa aaaa	AMBIENCE Output Level (MASTER)	0 - 127
00 00 13	0aaa aaaa	AMBIENCE Output Level (DIR1)	0 - 127
00 00 14	0aaa aaaa	AMBIENCE Output Level (DIR2)	0 - 127
00 00 15	0aaa aaaa	AMBIENCE Output Level (DIR3)	0 - 127
00 00 16	0aaa aaaa	EFFECT Output Level	0 - 127
00 00 17	0000 000a	AMBIENCE SW	0 - 1 (OFF, ON)
00 00 18	0000 000a	EFFECT SW	0 - 1 (OFF, ON)
00 00 19	0000 000a	COMP SW	0 - 1 (OFF, ON)
00 00 1A	0000 000a	EQ SW	0 - 1 (OFF, ON)
00 00 1B	0000 aaaa	AMBIENCE Type	0 - 9 (Beach, Living Room, Bath Room, Studio, Garage, Locker Room, Theater, Cave, Gymnasium, Dome Stadium)
00 00 1C	0000 0aaa	AMBIENCE Room Size	0 - 4 (Tiny, Small, Medium, Large, Huge)
00 00 1D	0000 00aa	AMBIENCE Wall Type	0 - 2 (Wood, Plaster, Glass)
00 00 1E	0000 000a	AMBIENCE Mic Position	0 - 1 (Low, High)
00 00 1F	000a aaaa	EFFECT Type	0 - 29
00 00 20	0aaa aaaa	EFFECT Param 1	0 - 127
00 00 21	0aaa aaaa	EFFECT Param 2	0 - 127
00 00 22	0aaa aaaa	EFFECT Param 3	0 - 127
00 00 23	0aaa aaaa	EFFECT Param 4	0 - 127
00 00 24	0000 000a	Stick Type	0 - 1 (Sticks, Brushes)
Total size	00 00 00 25		

## \* 1-2-2 DRUM KIT (Pad parameters)

Offset address	Description		
# 00	0000 aaaa	HEAD	Instrument 0 - 599
# 01	0000 bbbb		(1 - 600)
# 02	0000 cccc		
# 03	0000 dddd		
# 04	0000 aaaa	HEAD	Pitch (Head Tuning) -480 - +480
# 05	0000 bbbb		(-4800 - 4800cent, 10cent step)
# 06	0000 cccc		
# 07	0000 dddd		
08	0aaa aaaa	HEAD	Decay 33 - 95 (-31 - +31)
09	0aaa aaaa	HEAD	Level 0 - 127
0A	0aaa aaaa	HEAD	Note number 0 - 127
0B	0aaa aaaa	HEAD	Ambience Send Level 0 - 127
0C	0aaa aaaa	HEAD	Effect Send Level 0 - 127
0D	0aaa aaaa	HEAD	Play Pattern number 0 - 100
0E	0aaa aaaa	HEAD	MIDI Gate Time 1 - 80 (0.1s - 8.0s, 0.1s step)
# 0F	0000 aaaa	RIM	Instrument 0 - 599
# 10	0000 bbbb		(1 - 600)
# 11	0000 cccc		
# 12	0000 dddd		
# 13	0000 aaaa	RIM	Pitch (Head Tuning) -480 - 480
# 14	0000 bbbb		(-4800 - +4800cent, 10cent step)
# 15	0000 cccc		
# 16	0000 dddd		
17	0aaa aaaa	RIM	Decay 33 - 95 (-31 - +31)
18	0aaa aaaa	RIM	Level 0 - 127
19	0aaa aaaa	RIM	Note number 0 - 127
1A	0aaa aaaa	RIM	Ambience Send Level 0 - 127
1B	0aaa aaaa	RIM	Effect Send Level 0 - 127
1C	0aaa aaaa	RIM	Play Pattern number 0 - 100
1D	0aaa aaaa	RIM	MIDI Gate Time 1 - 80 (0.1s - 8.0s, 0.1s step)
1E	000a aaaa	Pan	0 - 30 (L15 - R15)
1F	0000 00aa	Output Assign	0 - 3 (MASTER, DIR1, DIR2, DIR3)
20	0000 000a	Compressor SW	0 - 1 (OFF, ON)
21	0aaa aaaa	Compressor Threshold	0 - 100 (-inf, -99db - 0db)
22	000a aaaa	Compressor Ratio	0 - 18 (1:1 - 9:1 (1step), 10:1 - 90:1 (10step), inf:1)
23	000a aaaa	Compressor Attack Time	0 - 31 (0.05 - 0.09 (0.01step), 0.1 - 0.9 (0.1step), 1.0 - 9.0 (1.0step),



24	000a aaaa	Compressor Release Time	10.0 - 50.0 (5.0step) 0 - 23 (0.05,0.07,0.1,0.5,1,5,10,17, 25,50,75,100,200,300,400,500, 600,700,800,900,1000,1200, 1500,2000 ms)
25	0aaa aaaa	Compressor Output Level	0 - 72 (-60 - +12db)
26	0000 000a	EQ SW	0 - 1 (OFF,ON)
27	0000 00aa	EQ HIGH Type	0 - 2 (Peaking, L.Shelving, H.Shelving)
28	000a aaaa	EQ HIGH Frequency	0 - 30 (20,25,31.5,40,50,63,80,100,125, 160,200,250,315,400,500,630,800, 1k,1.25k,1.6k,2k,2.5k,3.15k,4k, 5k,6.3k,8k,10k,12.5k,16k,20k)
29	0aaa aaaa	EQ HIGH Gain	49 - 79 (-15 - +15db)
2A	000a aaaa	EQ HIGH Q	0 - 20 (0.5,1.0 - 20.0, 0.1step)
2B	0000 00aa	EQ LOW Type	0 - 2 (Peaking, L.Shelving, H.Shelving)
2C	000a aaaa	EQ LOW Frequency	0 - 30 (20,25,31.5,40,50,63,80,100,125, 160,200,250,315,400,500,630,800, 1k,1.25k,1.6k,2k,2.5k,3.15k,4k, 5k,6.3k,8k,10k,12.5k,16k,20k)
2D	0aaa aaaa	EQ LOW Gain	49 - 79 (-15 - +15db)
2E	000a aaaa	EQ LOW Q	0 - 20 (0.5,1.0 - 20.0, 0.1step)
2F	0000 00aa	Mic Type	0 - 2 (*3) (1/KICK:Condenser,Dynamic1,Dynamic2) (2/SNARE:Condenser,Dynamic,Lo-Pi)
30	0000 00aa	Mic Position	0 - 2 (*4) (Outside,Standard,Inside)
31	0aaa aaaa		(*5)
32	0aaa aaaa		(*5)
33	0aaa aaaa		(*5)
34	0aaa aaaa		(*5)
35	0aaa aaaa		(*5)
36	0aaa aaaa		(*5)
Total size		00 00 00 37	

(\*3) 1/KICK, 2/SNARE only

(\*4) 1/KICK, 2/SNARE, 3/TOM1, 4/TOM2, 5/TOM3, 6/TOM4 only

(\*5) 1/KICK, 2/SNARE, 3/TOM1, 4/TOM2, 5/TOM3, 6/TOM4 only

Depending on the instrument group of the assigned instruments, settings are as follows.

**Instrument Group: V-KICK**

Offset address	Description	
31	0000 00aa	Head Type 0 - 2 (Clear,Coated,PinStripe*) PinStripe is a registered Trademark of Remo Inc. U.S.A.
32	0000 000a	Shell Depth 0 - 1 (Normal, Deep)
33	0000 0aaa	Muffling 0 - 4 (OFF,Tapel,Tape2,Blanket,Weight)
34	0000 0000	dummy (ignored)
35	0000 0000	dummy (ignored)
36	0000 0000	dummy (ignored)

**Instrument Group: V-SNARE**

Offset address	Description	
31	0000 00aa	Head Type 0 - 2 (Clear,Coated,PinStripe*) PinStripe is a registered Trademark of Remo Inc. U.S.A.
32	000a aaaa	Shell Depth 0 - 38 (1.0" - 20.0", 0.5step)
33	0000 0aaa	Muffling 0 - 4 (OFF,Tapel,Tape2,Daughnuts1,Daughnuts2)
34	0000 00aa	Shell Material 0 - 2 (Wood,Steel,Brass)
35	0000 00aa	Strainer Adjustment 0 - 3 (OFF,Loose,Medium,Tight)
36	0000 0000	dummy (ignored)

**Instrument Group: V-TOM**

Offset address	Description	
31	0000 00aa	Head Type 0 - 2 (Clear,Coated,PinStripe*) PinStripe is a registered Trademark of Remo Inc. U.S.A.
32	0000 000a	Shell Depth 0 - 1 (Normal, Deep)
33	0000 0aaa	Muffling 0 - 4 (OFF,Tapel,Tape2,Felt1,Felt2)
34	0000 0000	dummy (ignored)
35	0000 0000	dummy (ignored)
36	0000 0000	dummy (ignored)

**Instrument Group: ELEC KICK, ELEC SNARE, ELEC TOM1 - ELEC TOM4**

Offset address	Description		
31	0aaa aaaa	Attack	0 - 127
32	0aaa aaaa	Decay	0 - 127
33	0aaa aaaa	Noise	0 - 127
34	0aaa aaaa	Tone	0 - 127
35	0aaa aaaa	Bend	0 - 127
36	0aaa aaaa	Balance	0 - 127

**Instrument Group: TR808 KICK**

Offset address	Description		
31	0000 0000	dummy (ignored)	
32	0aaa aaaa	Decay	0 - 127
33	0aaa aaaa	Tune	0 - 127
34	0aaa aaaa	Tone	0 - 127
35	0000 0000	dummy (ignored)	
36	0000 0000	dummy (ignored)	

**Instrument Group: TR808 SNARE**

Offset address	Description		
31	0000 0000	dummy (ignored)	
32	0000 0000	dummy (ignored)	
33	0aaa aaaa	Tune	0 - 127
34	0aaa aaaa	Tone	0 - 127
35	0aaa aaaa	Snappy	0 - 127
36	0000 0000	dummy (ignored)	

**Instrument Group: TR808 TOM**

Offset address	Description		
31	0000 0000	dummy (ignored)	
32	0aaa aaaa	Decay	0 - 127
33	0aaa aaaa	Tune	0 - 127
34	0000 0000	dummy (ignored)	
35	0000 0000	dummy (ignored)	
36	0000 0000	dummy (ignored)	

**Instrument Group: TR909 KICK**

Offset address	Description		
31	0aaa aaaa	Attack	0 - 127
32	0aaa aaaa	Decay	0 - 127
33	0aaa aaaa	Tune	0 - 127
34	0000 0000	dummy (ignored)	
35	0000 0000	dummy (ignored)	
36	0000 0000	dummy (ignored)	

**Instrument Group: TR909 SNARE**

Offset address	Description		
31	0000 0000	dummy (ignored)	
32	0000 0000	dummy (ignored)	
33	0aaa aaaa	Tune	0 - 127
34	0aaa aaaa	Tone	0 - 127
35	0aaa aaaa	Snappy	0 - 127
36	0000 0000	dummy (ignored)	

**Instrument Group: TR909 TOM**

Offset address	Description		
31	0000 0000	dummy (ignored)	
32	0aaa aaaa	Decay	0 - 127
33	0aaa aaaa	Tune	0 - 127
34	0000 0000	dummy (ignored)	
35	0000 0000	dummy (ignored)	
36	0000 0000	dummy (ignored)	

**\* 1-3 PERCUSSION GROUP**

Offset address	Description		
16 00	Note #22 (Note parameters)		*1-3-1
:			
5D 00	Note #93 (Note parameters)		*1-3-1

# MIDI implementation

## \* 1-3-1 PERCUSSION GROUP (Note parameters)

Offset address	Description		
00	0000 aaaa	Instrument	0 - 599
# 01	0000 bbbb		(1 - 600)
# 02	0000 cccc		
# 03	0000 dddd		
04	0000 aaaa	Pitch	-480 - +480
05	0000 bbbb		(-4800 - +4800cent, 10cent step)
# 06	0000 cccc		
# 07	0000 dddd		
08	0aaa aaaa	Volume	0 - 127
09	000a aaaa	Pan	0 - 30
			(L15 - R15)
0A	0aaa aaaa	Decay	33 - 95
			(-31 - +31)
0B	0aaa aaaa	Ambience	0 - 127
0C	0aaa aaaa	Fx Send	0 - 127
0D	0000 00aa	Output	0 - 1
			(MASTER, PHONES ONLY)
Total size	00 00 00 0E		

## \* 1-4 PATTERN

Offset address	Description
00 00 00	All User Pattern Request
7F 7F 7F	User Pattern Data End

mm = User Pattern Number: 01H - 32H (Pattern No.51 - Pattern No.100)

\* Data size should be 00 00 00 00.

\* Data of demo song and Preset patterns cannot be transmitted.

## ■ Parameter Address Block Map

An outlined address map of the Exclusive Communication is as follows;

Address(H)	Block	Sub block	Reference
00 00 00 00	SETUP	TRIGGER BANK 1	Pad 1 *1-1-1-1
		:	:
		TRIGGER BANK 4	Pad 12
		:	:
		KIT CHAIN 1 (Name)	*1-1-2
		:	:
		KIT CHAIN16 (Name)	
		:	:
		KIT CHAIN 1 (Step)	Step 1 *1-1-3
		:	:
		KIT CHAIN16 (Step)	Step 32
		:	:
		MIDI	*1-1-4
		:	:
		PROGRAM CHANGE MAP	*1-1-5
		:	:
		CONTROL	*1-1-6
		:	:
		MASTER EQ	*1-1-7
		:	:
		MASTER TUNE	*1-1-8
		:	:
01 00 00 00	DRUM KIT	DRUM KIT 1	*1-2
		:	:
		DRUM KIT 50	
		:	:
04 00 00 00	PERCUSSION GROUP	PERCUSSION GROUP 1	Note #22 *1-3
		:	:
		PERCUSSION GROUP 4	Note #93
		:	:
10 00 00 00	PATTERN		
40 00 00 00	SETUP		
41 00 00 00	DRUM KIT		
44 00 00 00	PERCUSSION GROUP		

Bulk area  
↑  
↓  
v

## Section 4. Supplementary material

### Decimal and Hexadecimal table

In MIDI documentation, data values and addresses/sizes of exclusive messages etc. are expressed as hexadecimal values for each 7 bits.

The following table shows how these correspond to decimal numbers.

Dec.	Hex.	Dec.	Hex.	Dec.	Hex.	Dec.	Hex.
0	00H	32	20H	64	40H	96	60H
1	01H	33	21H	65	41H	97	61H
2	02H	34	22H	66	42H	98	62H
3	03H	35	23H	67	43H	99	63H
4	04H	36	24H	68	44H	100	64H
5	05H	37	25H	69	45H	101	65H
6	06H	38	26H	70	46H	102	66H
7	07H	39	27H	71	47H	103	67H
8	08H	40	28H	72	48H	104	68H
9	09H	41	29H	73	49H	105	69H
10	0AH	42	2AH	74	4AH	106	6AH
11	0BH	43	2BH	75	4BH	107	6BH
12	0CH	44	2CH	76	4CH	108	6CH
13	0DH	45	2DH	77	4DH	109	6DH
14	0EH	46	2EH	78	4EH	110	6EH
15	0FH	47	2FH	79	4FH	111	6FH
16	10H	48	30H	80	50H	112	70H
17	11H	49	31H	81	51H	113	71H
18	12H	50	32H	82	52H	114	72H
19	13H	51	33H	83	53H	115	73H
20	14H	52	34H	84	54H	116	74H
21	15H	53	35H	85	55H	117	75H
22	16H	54	36H	86	56H	118	76H
23	17H	55	37H	87	57H	119	77H
24	18H	56	38H	88	58H	120	78H
25	19H	57	39H	89	59H	121	79H
26	1AH	58	3AH	90	5AH	122	7AH
27	1BH	59	3BH	91	5BH	123	7BH
28	1CH	60	3CH	92	5CH	124	7CH
29	1DH	61	3DH	93	5DH	125	7DH
30	1EH	62	3EH	94	5EH	126	7EH
31	1FH	63	3FH	95	5FH	127	7FH

- \* Decimal values such as MIDI channel, bank select, and program change are listed as one(1) greater than the values given in the above table.
- \* A 7-bit byte can express data in the range of 128 steps. For data where greater precision is required, we must use two or more bytes. For example, two hexadecimal numbers aa bbH expressing two 7-bit bytes would indicate a value of  $aa \times 128 + bb$ .
- \* In the case of values which have a +- sign, 00H = -64, 40H = +- 0, and 7FH = +63, so that the decimal expression would be 64 less than the value given in the above chart. In the case of two types, 00 00H = -8192, 40 00H = +- 0, and 7F 7FH = +8191. For example if aa bbH were expressed as decimal, this would be  $aa \text{ bbH} - 40 \text{ 00H} = aa \times 128 + bb - 64 \times 128$ .

<Example 1> What is the decimal expression of 5AH ?

From the preceding table, 5AH = 90

<Example 2> What is the decimal expression of the value 12 34H given as hexadecimal for each 7 bits?

From the preceding table, since 12H = 18 and 34H = 52  
 $18 \times 128 + 52 = 2356$

### Examples of actual MIDI message

<Example 1> 92 3E 5F

9n is the Note-on status, and n is the MIDI channel number. Since 2H = 2, 3EH = 62, and 5FH = 95, this is a Note-on message with MIDI CH = 3, note number 62 (note name is D4), and velocity 95.

<Example 2> C9 20

CnH is the Program Change status, and n is the MIDI channel number. Since 9H = 9 and 20H = 32, this is a Program Change message with MIDI CH = 10, program number 33 (33 - SockHop).

<Example 3> EA 00 28

EnH is the Pitch Bend Change status, and n is the MIDI channel number. The 2nd byte (00H=0) is the LSB and the 3rd byte (28H=40) is the MSB, but Pitch Bend Value is a signed number in which  $40 \text{ 00H} (= 64 \times 128 + 0 - 8192)$  is 0, so this Pitch Bend Value is  $28 \text{ 00H} - 40 \text{ 00H} = 40 \times 128 + 0 - (64 \times 128 + 0) = 5120 - 8192 = -3072$

<Example 4> B3 64 00 65 00 06 0C 26 00 64 7F 65 7F

BnH is the Control Change status, and n is the MIDI channel number. For Control Changes, the 2nd byte is the control number, and the 3rd byte is the value. In a case in which two or more messages consecutive messages have the same status, MIDI has a provision called "running status" which allows the status byte of the second and following messages to be omitted. Thus, the above messages have the following meaning.

(B3)	64 00	MIDI ch.4, lower byte of RPN parameter number:	00H
(B3)	65 00	(MIDI ch.4) upper byte of RPN parameter number:	00H
(B3)	06 0C	(MIDI ch.4) upper byte of parameter value:	0CH
(B3)	26 00	(MIDI ch.4) lower byte of parameter value:	00H
(B3)	64 7F	(MIDI ch.4) lower byte of RPN parameter number:	7FH
(B3)	65 7F	(MIDI ch.4) upper byte of RPN parameter number:	7FH

In other words, the above messages specify a value of 0C 00H for RPN parameter number 00 00H on MIDI channel 4, and then set the RPN parameter number to 7F 7FH.

RPN parameter number 00 00H is Pitch Bend Sensitivity, and the MSB of the value indicates semitone units, so a value of 0CH = 12 sets the maximum pitch bend range to +- 12 semitones (1 octave). (On GS sound sources the LSB of Pitch Bend Sensitivity is ignored, but the LSB should be transmitted anyway (with a value of 0) so that operation will be correct on any device.)

Once the parameter number has been specified for RPN or NRPN, all Data Entry messages transmitted on that same channel will be valid, so after the desired value has been transmitted, it is a good idea to set the parameter number to 7F 7FH to prevent accidents. This is the reason for the (B3) 64 7F (B3) 65 7F at the end.

It is not desirable for performance data (such as Standard MIDI File data) to contain many events with running status as given in <Example 4>. This is because if playback is halted during the song and then rewind or fast-forwarded, the sequencer may not be able to transmit the correct status, and the sound source will then misinterpret the data. Take care to give each event its own status.

It is also necessary that the RPN or NRPN parameter number setting and the value setting be done in the proper order. On some sequencers, events occurring in the same (or consecutive) clock may be transmitted in an order different than the order in which they were received. For this reason it is a good idea to slightly skew the time of each event (about 1 tick for TPQN=96, and about 5 ticks for TPQN=480).

\* TPQN : Ticks Per Quarter Note

### Example of an Exclusive message and calculating a Checksum

Roland Exclusive messages (RQ1, DT1) are transmitted with a checksum at the end (before F7) to make sure that the message was correctly received. The value of the checksum is determined by the address and data (or size) of the transmitted exclusive message.

#### How to calculate the checksum (hexadecimal numbers are indicated by 'H')

The checksum is a value derived by adding the address, size and checksum itself and inverting the lower 7 bits.

Here's an example of how the checksum is calculated. We will assume that in the exclusive message we are transmitting, the address is aa bb cc ddH and the data or size is ee ff gg hhH.

$$\begin{aligned} aa + bb + cc + dd + ee + ff + gg + hh &= \text{sum} \\ \text{sum} / 128 &= \text{quotient} \dots \text{remainder} \\ 128 - \text{remainder} &= \text{checksum} \end{aligned}$$

(However, the checksum will be 0 if the remainder is 0.)

<Example 1> Setting Shell depth of snare drum in drum kit 1 to 3.5".

According to the "Parameter Address Map", the Drumkit No.1 has an address of 01 00 00H, Trigger 2 has an offset address of 02 00H and Shell depth has an offset address of 32H. Thus,

$$\begin{array}{r} 01 \ 00 \ 00 \ 00 \\ \quad \quad 02 \ 00 \\ +) \quad \quad 32 \\ \hline 01 \ 00 \ 02 \ 32 \end{array}$$

## MIDI implementation

---

and 3.5" is a value of 05,

F0	41	10	00 0A	12	01 00 02 32	05	??	F7
(1)	(2)	(3)	(4)	(5)	address	size	checksum	(6)

(1) Exclusive status      (2) ID number (Roland)    (3) Device ID (17)  
(4) Model ID (TD-10)    (5) Command ID (DT1)    (6) EOX

Next we calculate the checksum.

$01H + 00H + 02H + 32H + 05H = 1 + 0 + 2 + 50 + 5 = 58$  (sum)  
 $58 \text{ (sum)} / 128 = 0$  (quotient) ... 58 (remainder)  
 $\text{checksum} = 128 - 58 \text{ (remainder)} = 70 = 46H$

This means that F0 41 10 00 0A 12 01 00 02 32 05 46 F7 is the message we transmit.

### <Example 2> Requesting transmission of compressor switch of snare drum in drum kit 1.

According to the "Parameter Address Map", the Drumkit No.1 has an address of 01 00 00 00H, Trigger 2 has a offset address of 02 00H and Compressor switch has a offset address of 20H. Thus,

01 00 00 00
02 00
+) 20
01 00 02 20

Since Size = 00 00 00 01H,

F0	41	10	00 0A	11	01 00 02 20	00 00 00 01	??	F7
(1)	(2)	(3)	(4)	(5)	address	size	checksum	(6)

(1) Exclusive status      (2) ID number (Roland)    (3) Device ID (17)  
(4) Model ID (TD-10)    (5) Command ID (RQ1)    (6) EOX

Next we calculate the checksum.

$01H + 00H + 02H + 20H + 00H + 00H + 00H + 01H = 1 + 0 + 2 + 32 + 0 + 0 + 0 + 1 = 36$  (sum)  
 $36 \text{ (sum)} / 128 = 0$  (quotient) ... 36 (remainder)  
 $\text{checksum} = 128 - 36 \text{ (remainder)} = 92 = 5CH$

This means that F0 41 10 00 0A 11 01 00 02 20 00 00 01 5C F7 is the message we transmit.

# MIDI implementation Chart

PERCUSSION SOUND MODULE (TRIGGER SECTION)

Date : May. 1, 1997

Model TD-10

## MIDI Implementation Chart

Version : 1.00

Function...	Transmitted	Recognized	Remarks
Basic Default Channel Changed	1-16, OFF 1-16, OFF	X X	Memorized (Non-Volatile)
Mode Default Messages Altered	MODE 3 X *****	X X	
Note Number : True Voice	0-127 *****	X	
Velocity Note ON Note OFF	O 9nH, v = 1-127 O 8nH, v = 64	X X	
After Key's Touch Ch's	O X	X X	
Pitch Bend	X	X	
Control Change	1 X *1 4 O *1 6 X 7 X 10 X 16 O *1 17 O *1 64 X 100, 101 X	X X X X X X X X X	Modulation Foot control Data entry Volume Panpot General purpose controller 1 General purpose controller 2 Hold 1 RPN LSB, MSB
Program Change : True #	X *****	X	
System Exclusive	O	O	Only reception / transmission of Bulk Data.
System : Song Pos Common : Song Sel : Tune	X X X	X X X	
System : Clock Real Time : Commands	X X	X X	
Aux : All sound off Message : Reset all controllers : Local ON/OFF : All Notes OFF : Active Sense : System Reset	X X X X X X	X X X X X X	
Notes	* 1 O X is selectable.		

Mode 1 : OMNI ON, POLY  
Mode 3 : OMNI OFF, POLY

Mode 2 : OMNI ON, MONO  
Mode 4 : OMNI OFF, MONO

O : Yes  
X : No

PERCUSSION SOUND MODULE (SOUND MODULE SECTION)

Date : May. 1, 1997

Model TD-10

**MIDI Implementation Chart**

Version : 1.00

Function...	Transmitted	Recognized	Remarks
Basic Default Channel Changed	X X	1-16, OFF 1-16, OFF	Memorized (Non-Volatile)
Mode Default Messages Altered	X X *****	MODE 3 X	
Note Number : True Voice	X *****	0-127 0-127	
Velocity Note ON Note OFF	X X	O 9nH, v = 1-127 O 8nH, v = 64	
After Key's Touch Ch's	X X	O X	
Pitch Bend	X	O *3	
Control Change 1 4 6 7 10 16 17 64 100, 101	X X X X X X X X X	X O O O O O O O O	*1, 2 *1, 2  *3 *1, 2 *1, 2 *3 *3 Modulation Foot control Data entry Volume Panpot General purpose controller 1 General purpose controller 2 Hold 1 RPN LSB, MSB
Program Change : True #	O *****	O	Program Number Backing Part : 1-54 Drum Part : 1-128
System Exclusive	O	O	
System : Song Pos Common : Song Sel : Tune	X X X	X X X	
System : Clock Real Time : Commands	X X	X X	
Aux : All sound off Message : Reset all controllers : Local ON/OFF : All Notes OFF : Active Sense : System Reset	X X X X X X	O (120, 126, 127) O O X O O X	(123 -127)
Notes	* 1 O X is selectable. * 2 Drum part only. * 3 Backing part only.		

Mode 1 : OMNI ON, POLY  
Mode 3 : OMNI OFF, POLY

Mode 2 : OMNI ON, MONO  
Mode 4 : OMNI OFF, MONO

O : Yes  
X : No

PERCUSSION SOUND MODULE (SEQUENCER SECTION)

Date : May. 1, 1997

Model TD-10

**MIDI Implementation Chart**

Version : 1.00

Function...	Transmitted	Recognized	Remarks
Basic Default Channel Changed	1-16, OFF 1-16, OFF	1-16, OFF 1-16, OFF	Memorized (Non-Volatile)
Mode Default Messages Altered	MODE 3 X *****	X X	
Note Number : True Voice	0-127 *****	0-127 0-127	
Velocity Note ON Note OFF	O 9nH, v = 1-127 O 8nH, v = 64	O 9nH, v = 1-127 O 8nH, v = 64	
After Key's Touch Ch's	X X	X X	
Pitch Bend	O *6	O *6	
Control Change 1 4 6 7 10 16 17 64 100, 101	X *1 O *1 O O *2 O *2 O *1 O *1 O O O	X *1, 5 O *1, 5 X X X O O O O X	Modulation Foot control Data entry Volume Panpot General purpose controller 1 General purpose controller 2 Hold 1 RPN LSB, MSB
Program Change : True #	O *2 *****	X	Program Number Backing Part : 1-54 Drum Part : 1-128
System Exclusive	O	O (do not record)	Only reception / transmission of Bulk Data.
System : Song Pos Common : Song Sel : Tune	O O X	X O X	*4
System : Clock Real Time : Commands	O O	X X	*1, *3 *1, *4
Aux Message : All sound off : Reset all controllers : Local ON/OFF : All Notes OFF : Active Sense : System Reset	X X X X O X	O O X O O X	(123 -127)
Notes	* 1 O X is selectable. * 5 Drum part only. * 2 Only when pattern is selected. * 6 Backing part only. * 3 Receives when "Sync Mode" setting is "External," "Auto," or "MIDI→DELAY." * 4 Receives when "Sync Mode" setting is "External," "Auto," or "Remote."		

Mode 1 : OMNI ON, POLY  
Mode 3 : OMNI OFF, POLY

Mode 2 : OMNI ON, MONO  
Mode 4 : OMNI OFF, MONO

O : Yes  
X : No

## ● Sound Generator

Variable Drum Modeling

## ● Maximum Polyphony

56 Voices

## ● Instruments

Drum Instruments: 600

Backing Instruments: 54

## ● Drum Kits

50

## ● Drum Kit Chains

16 chains (32 steps per chain)

## ● Instrument Parameters

Acoustic Drum: Shell material, Shell depth, Head type, Head tuning, Muffling, Strainer adjustment

Electronic Drum: Attack, Tone pitch, Noise pitch, Decay, Noise tone balance, Pitch bend

TR-808, TR-909: Attack, Tune, Tone, Snappy, Decay

Others: Pitch, Decay

## ● Studio Parameters

Studio types: 10

Room size, Wall type, Ambience mic position

Mic type, Mic position

## ● Mixer Parameters

Volume, Pan, Output select

## ● Compressor / Equalizer

Compressor x 10

2-band parametric equalizer x 10

3-band master equalizer

## ● Effect Types

30 Reverb (14 types)

Delay (4 types)

Flanger → Delay (2 types)

Phaser → Delay (2 types)

Chorus → Delay (2 types)

Pitch shift delay (2 types)

3D-Delay (2 types)

Flying 3D-Delay (2 types)

## ● Note Number Map (Percussion Group)

4 Note Number Range: 22-93

## ● Trigger Parameters

Trigger type (Scan time, Retrigger Cancel, Mask time, Crosstalk)

Sensitivity, Threshold, Curve

## ● Sequencer

Preset Patterns: 50, User Patterns: 50

Tracks: 4

Play Function: One shot, Loop, Tap

Resolution: 192 ticks per quarter note

Recording Method: Real-time

## ● Metronome Parameters

Time Signature, Interval, Volume, Output select (Master/Phones only)

Instruments: 16 (Voice counting, Click, Cowbell, etc.)

## ● Tempo

20-260

## ● Display

64x160 dots backlit graphic LCD

8-segment, 3-character LED

## ● Sliders

6 Kick, Snare, Hi-Hat, Others, Backing, Click

## ● Preview Button

1 (touch sensitive)

## ● Connectors

Trigger Input jack (dual) x 12

Output jack x 8 (4 stereo pairs)

Phones jack

Monitor Mix In jack (Stereo)

Hi-Hat control jack

Footswitch jack (dual)

MIDI Connector (IN, OUT/THRU)

Expansion Board Slot

Memory Card Slot

## ● Output Separation: 76 dB (min.)

(MASTER L -> DIRECT L, MASTER R -> DIRECT R): 45 dB (min.)

(DIRECT L -> Other DIRECT L, DIRECT R -> Other DIRECT R): 45 dB (min.)

## ● Nominal Output level

+4 dBu (Audio Output)

## ● Output Impedance

330 ohms

## ● Power Supply

AC 117 V, 230 V, 240 V

## ● Power Consumption

18 W

## ● Dimensions

305 (W) x 245 (D) x 90 (H) mm

12-1/16 (W) x 9-11/16 (D) x 3-9/16 (H) inches

## ● Weight

2.3 kg / 5 lbs 2 oz

## ● Accessories

Owners manual, AC cord, Screws (M5 x 12) x 4

## ● Options

Wave & System Expansion Board (TDW-1)

Pad (PD-120, PD-100, PD-80R, PD-80, PD-9, PD-7, PD-6)

Cymbal (CY-15R, CY-14C, CY-12R/C, CY-12H, CY-6)

Kick Trigger (KD-120, KD-80, KD-7)

Hi-Hat Control Pedal (FD-7)

Drum Stand (MDS-10, MDS-8, MDS-7U, MDS-6)

Cymbal Mount (MDY-10U)

Pad Mount (MDH-10U)

Footswitch (BOSS: FS-5U)

Memory Card (M-512E)

Trigger MIDI Converter (TMC-6)

0dBu = 0.775Vrms

\* In the interest of product improvement, the specifications and/or appearance of this unit are subject to change without prior notice.



## Acoustic Drum

This refers to conventional/acoustic drum sounds in the TD-10, different of course from the Electronic sounds also available.

## Ambience

This is the actual environment WHERE the drums are being played, with the possibility to change the size of the room, the wall materials and the positions of the ambience mikes.

## Ambience Output Level

This refers to the total level of ambience for the entire drum kit. It's similar to the "return level" of effect units routed back to a mixer.

## Ambience Send Level

This refers to the individual send level of each instrument to the ambience itself.

## Append

This is an editing function of the TD-10's sequencer, which joins or combines two patterns into one pattern.

## AUX1, 2 jacks

These are trigger input jacks for additional pads. Pads connected to these jacks can be used as pad "switches" for various functions as well as for triggering sounds, though the equalizer and compressor cannot be used with sounds triggered from these inputs.

## Bulk Dump

This is a function that transmits various types of TD-10 data from the MIDI OUT connector for storage or "back up" on an external device. To do so, you will need a MIDI cable and an external sequencer. This data can be only be used by the TD-10.

## Chain

Refer to "Drum Kit Chain."

## Choking

This is a performance technique whereby, after a PD-7 or PD-9 has been hit, the edge of the pad is pinched by hand to mute the decay (length) of the triggered sound. (similar to choking a real cymbal by grabbing it)

## Click

This is the sound the metronome makes. It can be used as a "stand alone" tempo reference or when the sequencer is recording or playing back.

## Compressor

This is an effect unit found in all studios, used in controlling volume peaks to maintain a desired listening level. It's also used to change the tonal character and is an important tool in final sound finishing work.

## Controller

Controllers are devices which are used to input MIDI performance data, such as keyboards, guitar controllers, and pad controllers. (SPD-11/PAD-80 etc.)

## CONTROL ROOM

This is where you'll find the mixing console, compressors, EQ's and digital effects. It's one of the three key elements (instrument, studio, control room) which make up the TD-10's operating structure.

## Cursor

This is the highlighted portion in the display, indicating the parameter being edited at that moment. Use the VALUE dial or [INC/DEC] to adjust the highlighted parameter.

## DEC Button

Each time this button is pressed, the on-screen value at the cursor location will decrease in steps of 1, useful when making fine adjustments. When making on/off settings, pressing this button will turn the setting OFF. If making large changes in the value of a setting, the VALUE dial is quicker.

## Decay

This parameter is used in sound editing, adjusting the decay time (length).

## DIRECT 1, 2, 3

These jacks can be used for individual outputs (in stereo or mono) for more "separation control" or when using external effect devices, mixers etc. or for outputting just the ambience alone. Digital effects are output only from the MASTER outputs.

## Drum Kit

The combination of all settings for instruments, studio, and control room are referred to as a drum kit.

## Drum Kit Chain

You can use the Drum Kit Chain function to create a sequence of up to 32 kits, allowing you use them in the desired order or preference.

## Drum Trigger

A drum trigger is a sensor attached directly on an acoustic drum, sending a signal that will trigger sounds from the TD-10.

### **EDIT**

Editing is modifying a sound, effect, or musical data in the sequencer.

### **Effects**

The TD-10 has a variety of digital effects such as reverb, delay, flanger, chorus, and phaser. It's sometimes abbreviated in the TD-10's display as "FX."

### **Equalizer (EQ)**

An equalizer usually divides sound into high, mid & low frequency ranges, allowing their balance to be adjusted. The TD-10 provides 2-band equalizers for the instruments (not usable with instruments assigned to the AUX1, 2 jacks), and a 3-band equalizer for the total sound of the TD-10.

### **Expansion Board**

This is a board (optional) containing more instrumental sounds to be added to the TD-10, and is installed in the slot on the bottom panel.

### **FD-7**

A hi-hat controller pedal.

### **Foot Switch**

A separately sold foot switch (BOSS FS-5U) can be used to select kits, and perform operations such as sequencer play-back/stop etc.

### **FS-5U**

A general-purpose pedal that can be used with the TD-10, and as a foot switch for other devices or instruments.

### **FX**

This is an abbreviation for EFFECTS, indicating the on board effects unit.

### **FX Send Level**

This adjusts the volume of the instrument sent to the effect unit.

### **Function Buttons**

These are the four buttons [F1][F2][F3][F4] located below the display. The function of these buttons will change depending on what's in the screen, and the names of their current functions are shown in the bottom of the display.

### **Hi-Hat Control Pedal (FD-7)**

A pedal for controlling the hi-hat.

### **INC Button**

Each time this button is pressed, the on-screen value at the cursor location will increase in steps of 1, useful when making fine adjustments. When making on/off settings, pressing this button will turn the setting ON. If making large changes in the value of a setting, the VALUE dial is quicker.

### **Initialize**

This operation returns all settings to their factory values.

### **INST**

This refers to whole family of drum and percussion sounds. (In the case of "parts" used in a pattern, they are referred to with their actual names such as piano, guitar etc.)

### **KD-7**

This is a Kick Trigger Unit. (ROLAND)

### **Kick Trigger Unit**

A kick drum triggering device.

### **M-512E**

A memory card that can be used with the TD-10, and other Roland instruments.

### **MASTER OUTPUT**

These jacks output all sounds as well as the TD-10's internal effects. (Except when using individual outputs of course)

### **MEMORY CARD**

An external storage media on which TD-10 drum kits or sequencer data can be saved. It is inserted into the memory card slot (MEMORY CARD) located on the rear panel of the TD-10. The TD-10 can use "M-512E" memory cards.

### **MIDI (Musical Instrument Digital Interface)**

An international standard for allowing electronic musical instruments to communicate. Virtually all electronic musical instruments sold today support MIDI, allowing those instruments (even ones made by manufacturers other than Roland) to be used to play the TD-10. Pads connected to the TD-10 can also play external sound modules or samplers as well via MIDI.

### **MIDI connector**

These connectors are used to expand the TD-10's functionality, such as synchronizing (the tempo) with other devices, to record performances, and to store data. Use a MIDI cable to connect other MIDI-compatible instruments or devices to the TD-10. MIDI connectors are used ONLY if you are using an external MIDI device.

**MIDI Soft Thru**

The MIDI OUT/THRU connector of the TD-10 normally functions as MIDI OUT. When the MIDI Soft Thru setting is turned on, messages received at MIDI IN will be re-transmitted from the OUT/THRU connector.

System exclusive messages will not be transmitted.

**MIX IN**

An external sound source or CD player can be connected to this jack, so that it can be monitored with the TD-10's sound from the MIX out and/or the headphone jack. (or sent to the headphone only-switchable) Use the [MIX IN] knob on the front panel to adjust the volume.

**Muffling**

This is a technique in which the vibrations of a drum head are dampened with tape or other materials in order to adjust the overtones of the sound. On the TD-10 you can select various types of muffling: unmuted, muting with tape, a ring mute, felt or a blanket. (depending on the choice of drum)

**Note Number**

Every instrumental sound is assigned to a note of the keyboard, including the drum sounds and the percussion groups.

**Pad Switch**

This function allows a pad to be used for operations such as selecting drum kits, starting/stopping playback of the sequencer, etc.

**Pad Pattern**

This function allows you to specify a pattern that will be played when a pad is struck even though hitting a pad normally triggers a sound. With the TD-10 you can do both!

**Parameter**

"Shell Depth" or "Volume" are examples of sound-related "parameters." "Tempo," and "Measure length" are examples of sequencer "parameters." The process of modifying any parameter is referred to as "editing."

**Part Mute**

This function temporarily silences a part during sequencer playback.

**Panpot**

This is the adjustment that determines the left/right placement of the sound in the stereo field. On the TD-10 the sound can be moved to left or right in 7 steps respectively.

**Pattern**

In the sequencer, a pattern is a unit of performance data containing data for any one or all of the four parts (Part 1, Part 2, Bass part, Drum part).

**PD-5**

A single trigger pad - 8-3/4 inch (222 mm) diameter. No "rim" function.

**PD-7**

A dual trigger pad - 7-9/16 inch (192 mm) diameter. The head surface and rim send independent trigger signals.

**PD-9**

A dual trigger pad - 10 inch (254 mm) diameter. The head surface and rim send independent trigger signals.

**PD-100**

A single trigger pad - 11-13/16 inch (300 mm) diameter. The head is a unique "mesh" type material allowing performance with brushes. No "rim" function.

**PD-120**

A dual trigger pad - 13-13/16 inch (350 mm) diameter. The head is a unique "mesh" type material allowing performance with brushes. The head surface and rim send independent trigger signals.

**Percussion Group**

When the TD-10 is triggered from an external MIDI controller source, (MIDI pad, sequencer or keyboard) 60 instruments are available in addition to the 12 instruments assigned to the pads. For each drum kit, you can assign any one of the 4 percussion groups.

**Positional sensing**

When an acoustic drum is hit, the sound will differ depending on whether it is played at the center of the head or towards the rim. The TD-10 gives you this capability by allowing the tone to change as the playing position changes, relative to the center or rim of the pad. (Snare drum or ride cymbal ONLY).

**Preview**

The [PREVIEW] button on the TD-10's front panel lets you audition a sound as you edit even if no pads are connected. (Velocity sensitive)

**Quick Play**

This is a playback function of the TD-10's sequencer that skips over any blank portion or pause at the beginning of sequence data so that playback begins immediately with the first MIDI event in the pattern.

### **Rim Shot**

A “rim shot” refers to striking the rim of a drum with a stick at the same time as hitting the head. Rim shots played with the TD-10 will trigger just the instrument assigned to the rim.

### **Recording**

In this owner’s manual, “recording” refers to recording a performance onto the sequencer, which only records the note number, velocity (force) and gate time (length-adjustable) of the strike. It does NOT record sound itself.

### **Reset Time**

This is a parameter in the sequencer’s Tap playback function, and specifies the duration of time after which playback can resume.

### **Sequencer**

A sequencer is either a hardware-type device (such as MC-50MKII etc) or musical software in a computer which records/plays back MIDI performances. Sequencers allow you to record using either a method referred to as “realtime recording,” (similar to conventional (audio) recording) or a method in which individual performance events are entered manually one after the other, (called “step recording.”) The TD-10’s sequencer only provides realtime recording.

### **Simulation**

This means to “imitate” or “copy” something. The TD-10 is a sound module that simulates a set of drums and its surroundings.

### **Sound Module**

This is an electronic musical instrument containing sounds to be triggered by separate controllers (pad, keyboards, sequencer etc.) via MIDI. The TD-10 can also be used as a sound module.

### **STEP**

In a Drum Kit Chain, “step” refers to the order in which the drum kits are selected. Since up to 32 drum kits can be specified, a chain of 32 steps can be created for recall.

### **STUDIO**

This is WHERE the drums are played and is one of the three main elements (instrument, studio, control room) in the TD-10’s sound producing structure. Here, the room itself can be modified (i.e. room size, wall material, ambience mic position) and the type and position of microphones on the instruments can also be selected.

### **Trigger**

When a pad is struck, a waveform of the vibration is output and transmitted to the sound module of the TD-10. This waveform is called the trigger signal. The trigger jacks on the rear panel receive these signals. The trigger indicator in the upper left of the panel indicates the reception status of the trigger signals.

### **VALUE Dial**

This dial provides a convenient way to make large changes in the value at the cursor location. For changing values in steps of 1, [INC/DEC] is easier.

### **V-drums System**

This refers to the drum system based on the TD-10, including the pads, pedals and rack.

### **V-EDIT**

This refers to the Variable Drum Modeling process which allows extensive editing parameters to be utilized. V-EDIT is available only for instruments supporting “V-EDIT” and only those assigned to trigger inputs 1–6.

### **V-SNARE, V-KICK, V-TOM**

These are instrument groups which allow V-EDIT. If you select one of these instruments for TRIGGER INPUT jacks 1–6, you will be able to perform V-EDIT operations (refer to p. 136).

# Index of screen displays

Here are the screen displays that will appear as a result of operations on the TD-10, in order of the buttons that are pressed.

The page on which the main explanation for each display appears is listed, so you can refer to the appropriate page for details.

## KIT

## CHAIN

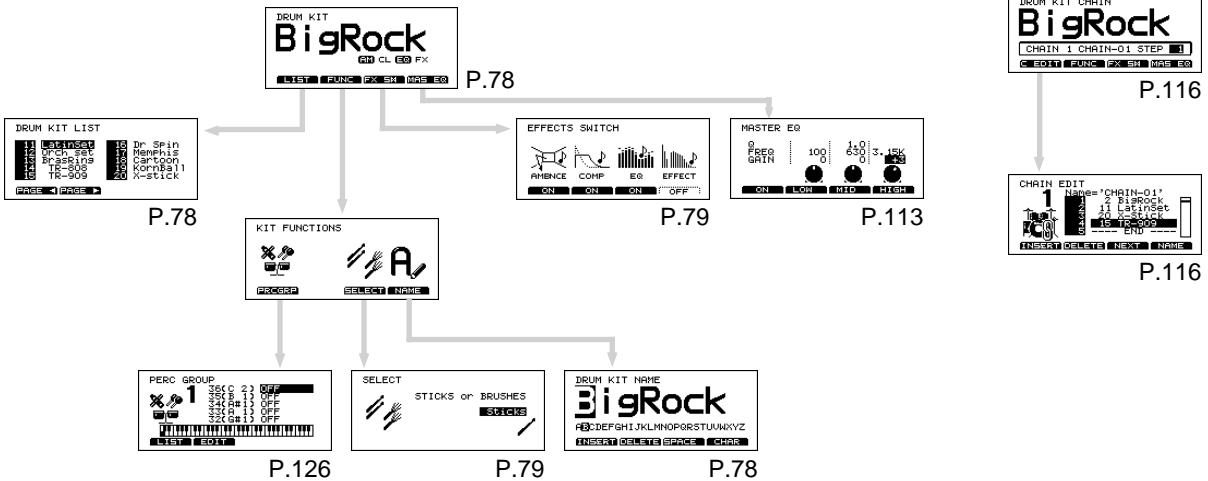

## INST

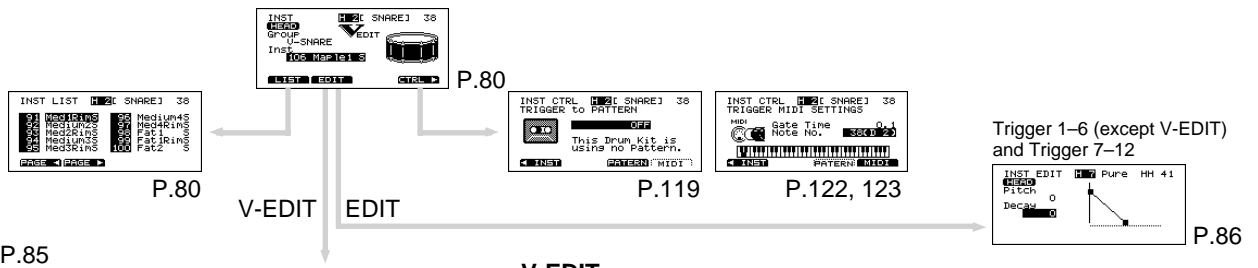

**V-EDIT**

	Accoustic	Electronic	TR-808	TR-909	
Trigger 1	INST EDIT 26" DeepK 36 Shell Depth SHELL HEAD HUFFLE	INST EDIT 26" DeepK 36 Head Tune Head Tuning SHELL HEAD HUFFLE	INST EDIT 26" DeepK 36 Muffling SHELL HEAD HUFFLE	INST EDIT Elec K 36 Att Tone No1 Dcy Bal Bend ATTACH TONANZ OVERBAL BEND	INST EDIT TR-808 K 36 Tune Decay Tone TUNE DECAY TONE
Trigger 2	INST EDIT Maple1 S 38 Material Wood Shell Depth SHELL HEAD HUFFLE	INST EDIT Maple1 S 38 Head Tune Head Tuning SHELL HEAD HUFFLE	INST EDIT Maple1 S 38 Muffling SHELL HEAD HUFFLE	INST EDIT Elec S 38 Att Tone No1 Dcy Bal Bend ATTACH TONANZ OVERBAL BEND	INST EDIT TR-808 S 38 Tune Snappy Tone TUNE SNAPPY TONE
Trigger 3-6	INST EDIT Dry T1 46 Shell Depth SHELL HEAD HUFFLE	INST EDIT Dry T1 46 Head Tune Head Tuning SHELL HEAD HUFFLE	INST EDIT Dry T1 46 Muffling SHELL HEAD HUFFLE	INST EDIT Elec T1 46 Att Tone No1 Dcy Bal Bend ATTACH TONANZ OVERBAL BEND	INST EDIT TR-808T1 46 Tune Decay TUNE DECAY

STUDIO

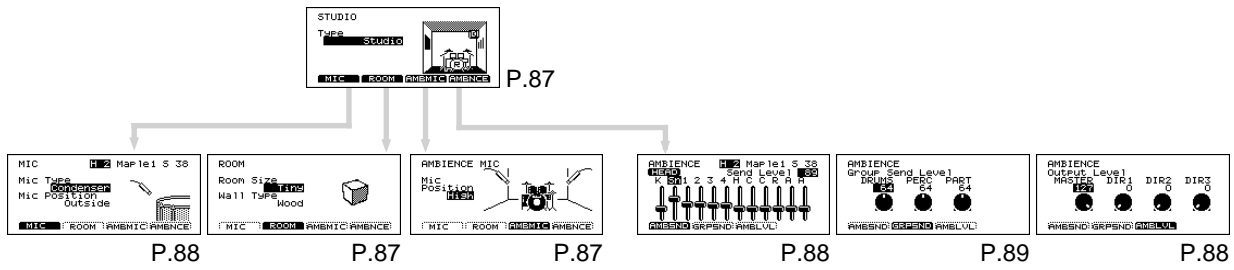

CONTROL ROOM

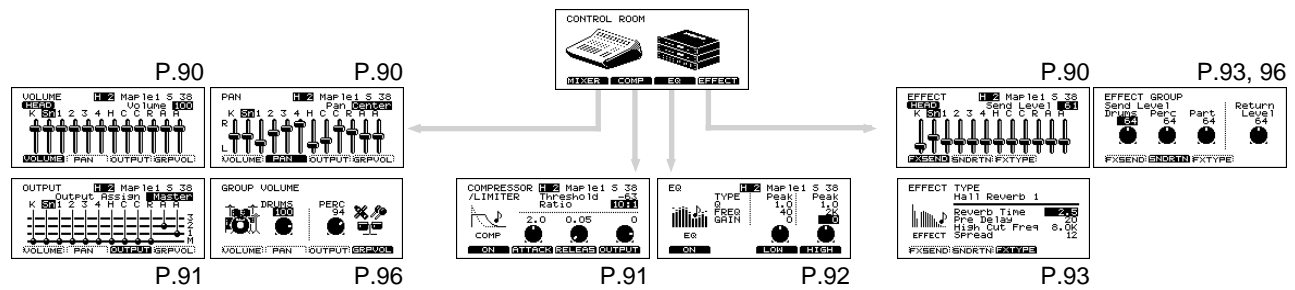

SETUP

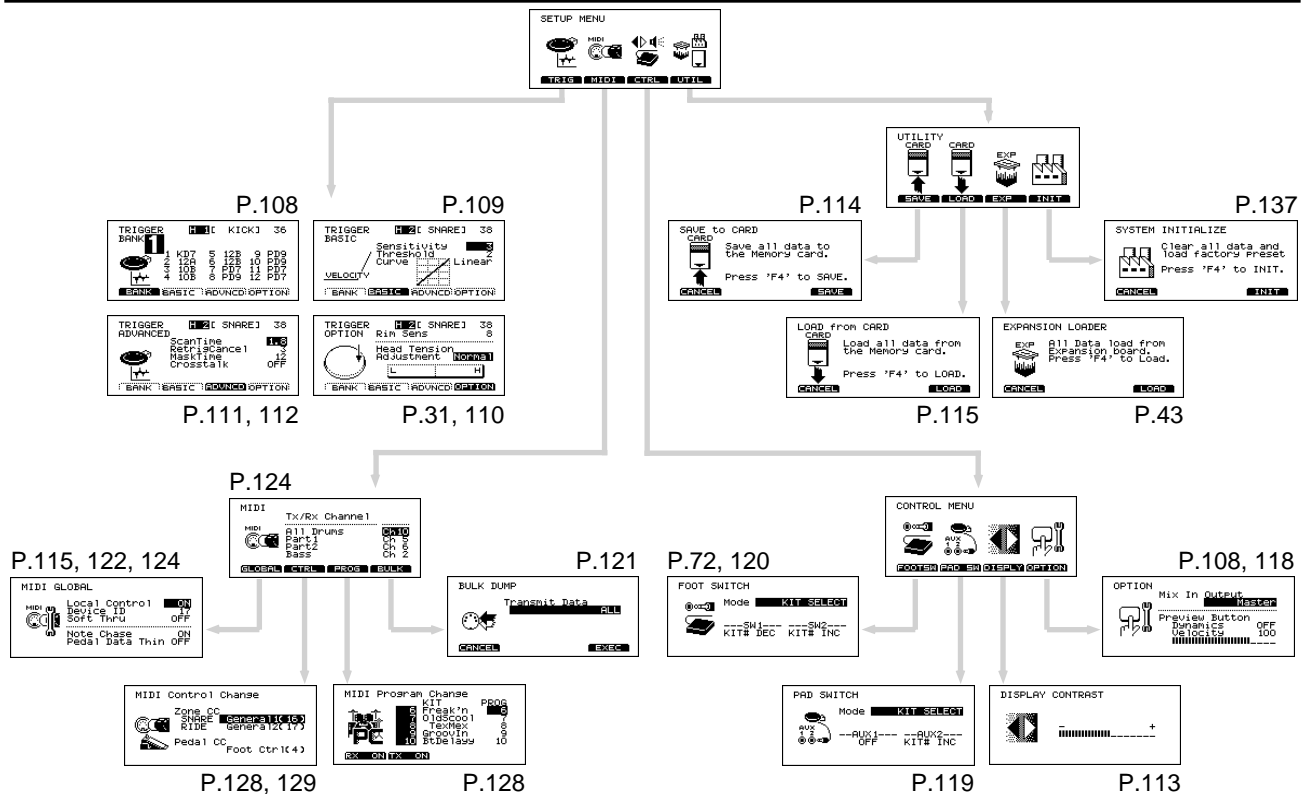

SEQUENCER

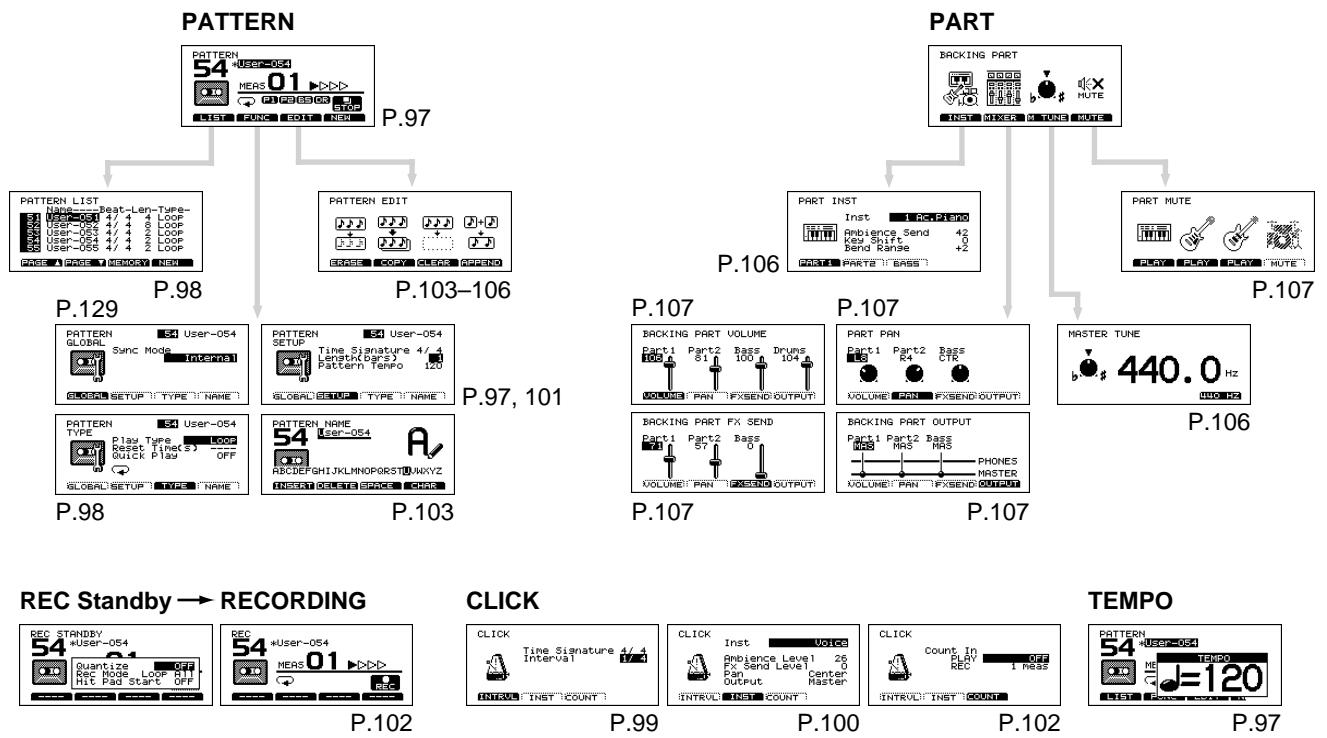

# Index

## A

ADVNC D .....	111
Ambience.....	87
Ambience (Percussion Group) .....	127
Ambience Group Send .....	89
Ambience Mic .....	87
Ambience Output Level .....	88
Ambience Send (Click) .....	100
Ambience Send (Pad) .....	88
Ambience Send (Part) .....	107
Append .....	106
Atk (Attack).....	84, 85
Auto (SYNC) .....	129
AUX1, 2 Jack .....	119

## B

Backing INST .....	101, 106
Bal (Balance).....	84
BANK (Trigger Bank) .....	29, 108
Basic (Trigger setting).....	109
Beat Delay.....	93, 94
Bend.....	53, 84
Bend Range .....	106
Brushes.....	36, 50
Bulk Dump .....	121

## C

CARD .....	17, 114
[CHAIN] .....	70, 116
Chain Name .....	116
Choking .....	35
Chorus → Delay.....	93, 95
Clear pattern .....	105
[CLICK].....	73, 97, 99
Compressor .....	91
Control Change .....	128, 129
[CONTROL ROOM] .....	47, 65, 90
Copy (TOOLS) .....	117
Copy Pattern (Measure) .....	104, 105
Count In.....	102
Crosstalk .....	112
[CURSOR].....	15, 18, 97
Curve.....	109

## D

Dcy (Decay) .....	84
[DEC].....	15, 19
Decay (INST).....	84, 85, 86
Decay (Percussion Group) .....	127
Delay .....	93, 94
Delete Pattern.....	105
Demo .....	28, 179

## E

Depth.....	57, 82
Device ID .....	122
DIRECT 1, 2, 3 Jack.....	16, 91
Display .....	113
Drum Kit.....	20, 38, 78
Drum Kit Chain .....	70, 116
Drum Kit List .....	38, 78
Drum Trigger .....	33, 112, 142
EDIT .....	81
EFFECT (Click) .....	100
EFFECT (Drum Kit) .....	93
EFFECT SWITCH .....	41, 79
EFFECT TYPE .....	93
Electronic Drum kit.....	52
EQ (Drum Kit) .....	66, 92
EQ (Master) .....	113
Erase Pattern .....	104
Error message .....	138
[Exit] .....	14
Expansion Board .....	43
External .....	129

## F

Flanger → Delay .....	93, 95
Flying 3D-Delay.....	93, 96
FOOT SWITCH.....	16, 72, 120
FREQ (EQ/Master) .....	113
FREQ (EQ/Pad).....	92
Function Button .....	14, 18
FX Send Level .....	90
FX Send (Group).....	96
FX Send (Pad) .....	90
FX Send (Part) .....	107
FX Send (Percussion Group).....	127
FX SW.....	41, 51, 54, 62, 65, 79

## G

Gain (EQ/Master) .....	113
Gain (EQ/Pad).....	92
Gate Reverb.....	93
Gate time.....	123
[Group Faders].....	15, 28, 37, 67
Group FX send.....	96
Group Volume.....	96

## H

Hall Reverb .....	93, 94
Head .....	19, 77
Head Tension Adjustment.....	31, 110
Head Tuning .....	59, 82
Head Type .....	58, 82



Help.....42, 118  
 HH CTRL Jack .....16  
 Hi-Hat Control Pedal.....36, 124, 128  
 Hit Pad Start.....102

**I**

[INC].....15, 19  
 Initialize .....137  
 [INST].....55, 80, 136  
 INST (Backing Part) .....106, 125  
 INST (Click).....100  
 INST (Percussion Group).....126  
 INST LIST .....80  
 Internal.....129  
 Interval.....99

**K**

Keyshift (Part).....106  
 [KIT] .....15, 20, 38, 78

**L**

LIST (Drum Kit).....38, 78  
 LIST (INST) .....80  
 LIST (Pattern).....98  
 LIST (Percussion Group).....126  
 Local Control.....124  
 Loop (Play) .....98  
 Loop (Recording).....102

**M**

M-512E.....114  
 MAS EQ (Master EQ).....40, 113  
 MaskTime .....112  
 [MASTER] .....15, 37, 45  
 MASTER OUTPUT Jack.....16, 23  
 Master Tune .....106  
 Material .....56, 81  
 MDS-10 .....22, 24  
 MDS-7U .....22  
 Memory (Pattern).....98  
 Memory Card.....114, 115  
 Memory Card Protect .....114  
 Memory Card Slot.....16, 17  
 Mic Position.....87, 88  
 Mic Type .....89  
 MIDI .....121, 140  
 MIDI Channel .....124, 140  
 MIDI IN Jack .....16, 140  
 MIDI OUT/THRU Jack .....16, 140  
 MIDI → Delay.....129  
 [MIX IN].....16, 37, 108  
 MIX IN Output .....108

Muffling.....60, 83  
 Mute (Part) .....107

**N**

NAME (Chain).....116  
 NAME (Drum Kit) .....78  
 NAME (Pattern).....103  
 Noi (Noise) .....84  
 Non Linear .....93, 94  
 Note Chase .....115  
 NOTE NO. (Pad) .....122, 125, 126, 127

**O**

One Shot .....98  
 Output (Click).....100  
 Output (Pad) .....91  
 Output (Part).....107  
 Output (Percussion Group) .....127  
 Output Jack (DIRECT 1-3).....16  
 Output Jack (MASTER) .....16

**P**

PAD PATTERN .....72, 119  
 PAD SWITCH.....119  
 Pan (Click) .....100  
 Pan (Pad) .....90  
 Pan (Part) .....107  
 Pan (Percussion Group).....127  
 Parameter .....171  
 [PART] .....97, 101, 106  
 Part Mute .....107  
 Part Volume .....107  
 [PATTERN] .....68, 97, 98, 101  
 Pattern List .....98  
 PD-7.....24, 25, 35, 36  
 PD-9.....24, 25, 35, 36  
 PD-100.....24, 30, 31, 36  
 PD-120.....24, 30, 31, 35, 36  
 Pedal CC .....128  
 Pedal Data Thin .....124  
 Percussion Group.....126  
 Phaser → Delay.....93, 95  
 [PHONES] .....15, 27, 37  
 PHONES Jack.....16  
 Pitch (Pad) .....86  
 Pitch (Percussion Group) .....127  
 Pitch Shift Delay .....93, 95  
 Plate Reverb .....93, 94  
 [PLAY] .....68, 97  
 Play Type.....98  
 POLARITY .....25  
 Positional Sensing .....36, 129  
 Preset Drum Kit.....20

## Index

Preset Pattern .....	97
[PREVIEW] .....	15, 27, 118
Program Change .....	124, 128
PROTECT (Card) .....	17, 114

### Q

Q .....	92, 113
Quantize .....	103
Quick Play .....	98

### R

[REC] .....	97, 102
Rec Mode .....	102
Remote .....	129
Replace .....	102
Reset Time .....	99
RetrigCancel .....	111
Return Level .....	93, 94
[RIM] .....	19, 20, 77
Rim Sensitivity .....	110
Rim Shot .....	35
Room Reverb .....	93
Room Size .....	64, 87

### S

ScanTime .....	111
SELECT .....	79
Sensitivity .....	39, 109
[SETUP] .....	14
Shell Depth .....	49, 57, 81, 82
Shell Material .....	56, 81
Snappy .....	85
Soft Thru .....	123
SPD-11 .....	123
Step .....	70, 116
[STOP] .....	97
Strainer Adj. .....	61, 83
[STUDIO] .....	15, 47, 63, 87
SYNC (MIDI) .....	129
System Initialize .....	137

### T

Tap .....	98
[TEMPO] .....	97, 99, 102
Threshold .....	109
Time signature .....	99, 101
Tone .....	84, 85
[TOOLS] .....	14
TR-808 .....	85
TR-909 .....	85
TRIGGER BANK .....	29, 108
TRIGGER Indicator .....	14, 45

Trigger Jack .....	24
TRIGGER TYPE .....	30, 108, 142
[TRIG SELECT] .....	15, 20
Tune (TR-808/909) .....	85
Tuning .....	59, 82
Type (Effect) .....	93
Type (EQ) .....	92
Type (Pad) .....	30, 108
Type (Studio) .....	87

### U

Undo .....	117
------------	-----

### V

[VALUE] .....	15, 19
V-Basic Kit .....	29
V-Drums System .....	76
V-EDIT .....	81
V-Standard Kit .....	29
Volume (Drum Kit) .....	127
Volume (Pad) .....	67, 90
Volume (Part) .....	107
Volume (Percussion Group) .....	127
Volume (Master) .....	15

### W

Wall Type .....	87
-----------------	----

### Z

Zone CC .....	129
---------------	-----

### Others

10A .....	30, 108
10B .....	108
12A .....	30, 108
12B .....	108
3D-Delay .....	93, 95

## About demo song

Song title	Composer	Copyright
Rainbow	Roland Corporation	© 1997, Roland Corporation

For EU Countries

### Apparatus containing Lithium batteries

#### ADVARSEL!

Lithiumbatteri - Eksplosionsfare ved fejlagtig håndtering.  
Udskiftning må kun ske med batteri af samme fabrikat og type.  
Levér det brugte batteri tilbage til leverandøren.

#### ADVARSEL

Eksplosjonsfare ved feilaktig skifte av batteri.  
Benytt samme batteritype eller en tilsvarende type anbefalt av apparatfabrikanten.  
Brukte batterier kasseres i henhold til fabrikantens instruksjoner.

#### CAUTION

Danger of explosion if battery is incorrectly replaced.  
Replace only with the same or equivalent type recommended by the manufacturer.  
Discard used batteries according to the manufacturer's instructions.

#### VARNING

Explosionsfara vid felaktigt batteribyte.  
Använd samma batterityp eller en ekvivalent typ som rekommenderas av apparattillverkaren.  
Kassera använt batteri enligt fabrikantens instruktion.

#### VAROITUS

Paristo voi räjähtää, jos se on virheellisesti asennettu.  
Vaihda paristo ainoastaan laitevalmistajan suosittelemaan tyyppiin. Hävitä käytetty paristo valmistajan ohjeiden mukaisesti.

For EU Countries



This product complies with the requirements of European Directives EMC 89/336/EEC and LVD 73/23/EEC.

For the USA

### FEDERAL COMMUNICATIONS COMMISSION RADIO FREQUENCY INTERFERENCE STATEMENT

This equipment has been tested and found to comply with the limits for a Class B digital device, pursuant to Part 15 of the FCC Rules. These limits are designed to provide reasonable protection against harmful interference in a residential installation. This equipment generates, uses, and can radiate radio frequency energy and, if not installed and used in accordance with the instructions, may cause harmful interference to radio communications. However, there is no guarantee that interference will not occur in a particular installation. If this equipment does cause harmful interference to radio or television reception, which can be determined by turning the equipment off and on, the user is encouraged to try to correct the interference by one or more of the following measures:

- Reorient or relocate the receiving antenna.
- Increase the separation between the equipment and receiver.
- Connect the equipment into an outlet on a circuit different from that to which the receiver is connected.
- Consult the dealer or an experienced radio/TV technician for help.

Unauthorized changes or modification to this system can void the users authority to operate this equipment.  
This equipment requires shielded interface cables in order to meet FCC class B Limit.

For Canada

#### NOTICE

This Class B digital apparatus meets all requirements of the Canadian Interference-Causing Equipment Regulations.

#### AVIS

Cet appareil numérique de la classe B respecte toutes les exigences du Règlement sur le matériel brouilleur du Canada.

# Information

When you need repair service, call your nearest Roland Service Center or authorized Roland distributor in your country as shown below.

## AFRICA

### EGYPT

**Al Fanny Trading Office**  
9, EBN Hagar Al Askalany Street,  
ARD El Golf, Heliopolis,  
Cairo 11341, EGYPT  
TEL: 20-2-417-1828

### REUNION

**Maison FO - YAM Marcel**  
25 Rue Jules Hermann,  
Chaudron - BP79 97 491  
Ste Clotilde Cedex,  
REUNION ISLAND  
TEL: (0262) 218-429

### SOUTH AFRICA

**That Other Music Shop  
(PTY) Ltd.**  
11 Melle St., Braamfontein,  
Johannesbourg, SOUTH AFRICA

P.O.Box 32918, Braamfontein 2017  
Johannesbourg, SOUTH AFRICA  
TEL: (011) 403 4105

### Paul Bothner (PTY) Ltd.

17 Werdmuller Centre,  
Main Road, Claremont 7708  
SOUTH AFRICA

P.O.Box 23032, Claremont 7735,  
SOUTH AFRICA  
TEL: (021) 674 4030

## ASIA

### CHINA

**Roland Shanghai Electronics  
Co., Ltd.**  
5F. No.1500 Pingliang Road  
Shanghai, CHINA  
TEL: (021) 5580-0800

### Roland Shanghai Electronics Co., Ltd.

**(BEIJING OFFICE)**  
10F. No.18 Anhuaxili  
Chaoyang District, Beijing,  
CHINA  
TEL: (010) 6426-5050

### HONG KONG

**Tom Lee Music Co., Ltd.  
Service Division**  
22-32 Pun Shan Street, Tsuen  
Wan, New Territories,  
HONG KONG  
TEL: 2415 0911

### INDIA

**Rivera Digitec (India) Pvt. Ltd.**  
409, Nirman Kendra Mahalaxmi  
Flats Compound Off. Dr. Edwin  
Moses Road, Mumbai-400011,  
INDIA  
TEL: (022) 2493 9051

### INDONESIA

**PT Citra IntiRama**  
J1. Cideng Timur No. 15J-150  
Jakarta Pusat  
INDONESIA  
TEL: (021) 6324170

### KOREA

**Cosmos Corporation**  
1461-9, Seocho-Dong,  
Seocho Ku, Seoul, KOREA  
TEL: (02) 3486-8855

### MALAYSIA

**BENTLEY MUSIC SDN BHD**  
140 & 142, Jalan Bukit Bintang  
55100 Kuala Lumpur, MALAYSIA  
TEL: (03) 2144-3333

### PHILIPPINES

**G.A. Yupangco & Co. Inc.**  
339 Gil J. Puyat Avenue  
Makati, Metro Manila 1200,  
PHILIPPINES  
TEL: (02) 899 9801

## SINGAPORE

**Swee Lee Company**  
150 Sims Drive,  
SINGAPORE 387381  
TEL: 6846-3676

## CRISTOFORI MUSIC PTE LTD

Blk 3014, Bedok Industrial Park E,  
#02-2148, SINGAPORE 489980  
TEL: 6243-9555

## TAIWAN

**ROLAND TAIWAN  
ENTERPRISE CO., LTD.**  
Room 5, 9fl. No. 112 Chung Shan  
N.Road Sec.2, Taipei, TAIWAN,  
R.O.C.  
TEL: (02) 2561 3339

## THAILAND

**Theera Music Co., Ltd.**  
330 Veng NakornKasem, Soi 2,  
Bangkok 10100, THAILAND  
TEL: (02) 2248821

## VIETNAM

**Saigon Music**  
138 Tran Quang Khai St.,  
District 1  
Ho Chi Minh City  
VIETNAM  
TEL: (08) 844-4068

## AUSTRALIA/ NEW ZEALAND

### AUSTRALIA

**Roland Corporation  
Australia Pty., Ltd.**  
38 Campbell Avenue  
Dee Why West, NSW 2099  
AUSTRALIA  
TEL: (02) 9982 8266

### NEW ZEALAND

**Roland Corporation Ltd.**  
32 Shaddock Street, Mount Eden,  
Auckland, NEW ZEALAND  
TEL: (09) 3098 715

## CENTRAL/LATIN AMERICA

### ARGENTINA

**Instrumentos Musicales S.A.**  
Av.Santa Fe 2055  
(1123) Buenos Aires  
ARGENTINA  
TEL: (011) 4508-2700

### BRAZIL

**Roland Brasil Ltda**  
Rua San Jose, 780 Sala B  
Parque Industrial San Jose  
Cotia - Sao Paulo - SP, BRAZIL  
TEL: (011) 4615 5666

### COSTA RICA

**JUAN Bansbach  
Instrumentos Musicales**  
Ave.1. Calle 11, Apartado 10237,  
San Jose, COSTA RICA  
TEL: 258-0211

### CHILE

**Comercial Fancy II S.A.**  
Rut.: 96.919.420-1  
Nataníel Cox #739, 4th Floor  
Santiago - Centro, CHILE  
TEL: (02) 688-9540

### EL SALVADOR

**OMNI MUSIC**  
75 Avenida Norte y Final  
Alameda Juan Pablo II,  
Edificio No.4010 San Salvador,  
EL SALVADOR  
TEL: 262-0788

### MEXICO

**Casa Veerkamp, s.a. de c.v.**  
Av. Toluca No. 323, Col. Olivar  
de los Padres 01780 Mexico D.F.  
MEXICO  
TEL: (55) 5668-6699

## PANAMA

**SUPRO MUNDIAL, S.A.**  
Boulevard Andrews, Albrook,  
Panama City, REP. DE PANAMA  
TEL: 315-0101

## PARAGUAY

**Distribuidora De  
Instrumentos Musicales**  
J.E. Olear y ESQ. Manduvira  
Asuncion PARAGUAY  
TEL: (021) 492-124

## URUGUAY

**Todo Musica S.A.**  
Francisco Acuna de Figueroa 1771  
C.P.: 11.800  
Montevideo, URUGUAY  
TEL: (02) 924-2335

## VENEZUELA

**Musicland Digital C.A.**  
Av. Francisco de Miranda,  
Centro Parque de Cristal, Nivel  
C2 Local 20 Caracas  
VENEZUELA  
TEL: (212) 285-8586

## EUROPE

### AUSTRIA

**Roland Austria GES.M.B.H.**  
Siemensstrasse 4, P.O. Box 74,  
A-6063 RUM, AUSTRIA  
TEL: (0512) 26 44 260

### BELGIUM/HOLLAND/ LUXEMBOURG

**Roland Benelux N. V.**  
Houtstraat 3, B-2260, Oevel  
(Westerlo) BELGIUM  
TEL: (014) 575811

### DENMARK

**Roland Scandinavia A/S**  
Nordhavnsvej 7, Postbox 880,  
DK-2100 Copenhagen  
DENMARK  
TEL: 3916 6200

### FRANCE

**Roland France SA**  
4, Rue Paul Henri SPAAK,  
Parc de l'Esplanade, F 77 462 St.  
Thibault, Lagny Cedex FRANCE  
TEL: 01 600 73 500

### FINLAND

**Roland Scandinavia As,  
Filial Finland**  
Elannontie 5  
FIN-01510 Vantaa, FINLAND  
TEL: (09) 68 24 020

### GERMANY

**Roland Elektronische  
Musikinstrumente HmbH.**  
Oststrasse 96, 22844 Norderstedt,  
GERMANY  
TEL: (040) 52 60090

### GREECE

**STOLLAS S.A.  
Music Sound Light**  
155, New National Road  
Patras 26442, GREECE  
TEL: 2610 435400

### HUNGARY

**Roland East Europe Ltd.**  
Warehouse Area 'DEPO' Pf.83  
H-2046 Torokbalint, HUNGARY  
TEL: (23) 511011

### IRELAND

**Roland Ireland**  
Audio House, Belmont Court,  
Donnybrook, Dublin 4,  
Republic of IRELAND  
TEL: (01) 2603501

## ITALY

**Roland Italy S. p. A.**  
Viale delle Industrie 8,  
20020 Arese, Milano, ITALY  
TEL: (02) 937-78300

## NORWAY

**Roland Scandinavia Avd.  
Kontor Norge**  
Lilleakerveien 2 Postboks 95  
Lilleaker N-0216 Oslo  
NORWAY  
TEL: 2273 0074

## POLAND

**P. P. H. Brzostowicz**  
UL. Gibraltarska 4,  
PL-03664 Warszawa POLAND  
TEL: (022) 679 44 19

## PORTUGAL

**Tecnologias Musica e Audio,  
Roland Portugal, S.A.**  
Cais Das Pedras, 8/9-1 Dto  
4050-465 PORTO  
PORTUGAL  
TEL: (022) 608 00 60

## ROMANIA

**FBS LINES**  
Piata Libertatii 1,  
RO-4200 Gheorgheni  
TEL: (095) 169-5043

## RUSSIA

**MuTek**  
3-Bogatyrskaya Str. 1.k.1  
107 564 Moscow, RUSSIA  
TEL: (095) 169 5043

## SPAIN

**Roland Electronics  
de España, S. A.**  
Calle Bolivia 239, 08020  
Barcelona, SPAIN  
TEL: (93) 308 1000

## SWEDEN

**Roland Scandinavia A/S  
SWEDISH SALES OFFICE**  
Danvik Center 28, 2 tr.  
S-131 30 Nacka SWEDEN  
TEL: (08) 702 00 20

## SWITZERLAND

**Roland (Switzerland) AG**  
Landstrasse 5, Postfach,  
CH-4452 Itingen,  
SWITZERLAND  
TEL: (061) 927-8383

## UKRAINE

**TIC-TAC**  
Mira Str. 19/108  
P.O. Box 180  
295400 Munkachevo, UKRAINE  
TEL: (03131) 414-40

## UNITED KINGDOM

**Roland (U.K.) Ltd.**  
Atlantic Close, Swansea  
Enterprise Park, SWANSEA  
SA7 9FJ,  
UNITED KINGDOM  
TEL: (01792) 702701

## MIDDLE EAST

### BAHRAIN

**Moon Stores**  
No.16, Bab Al Bahrain Avenue,  
P.O.Box 247, Manama 304,  
State of BAHRAIN  
TEL: 211 005

### CYPRUS

**Radex Sound Equipment Ltd.**  
17, Diagorou Street, Nicosia,  
CYPRUS  
TEL: (022) 66-9426

### IRAN

**MOCO, INC.**  
No.41 Nike St., Dr.Shariyati Ave.,  
Roberoye Cerahe Mirdamad  
Tehran, IRAN  
TEL: (021) 285-4169

## ISRAEL

**Halilit P. Greenspoon &  
Sons Ltd.**  
8 Retzif Ha'aliya Hashnya St.  
Tel-Aviv-Yafo ISRAEL  
TEL: (03) 6823666

## JORDAN

**AMMAN Trading Agency**  
245 Prince Mohammad St.,  
Amman 1118, JORDAN  
TEL: (06) 464-1200

## KUWAIT

**Easa Husain Al Yousifi Est.**  
Abdullah Salem Street,  
Safat, KUWAIT  
TEL: 243-6399

## LEBANON

**Chahine S.A.L.**  
Gerge Zeidan St., Chahine Bldg.,  
Achrafieh, P.O.Box: 16-5857  
Beirut, LEBANON  
TEL: (01) 20-1441

## QATAR

**Al Emadi Co. (Badie Studio  
& Stores)**  
P.O. Box 62,  
Doha, QATAR  
TEL: 4423-554

## SAUDI ARABIA

**aDawlah Universal  
Electronics APL**  
Corniche Road, Aldossary Bldg.,  
1st Floor, Alkhobar,  
SAUDI ARABIA

P.O.Box 2154, Alkhobar 31952  
SAUDI ARABIA  
TEL: (03) 898 2081

## SYRIA

**Technical Light & Sound  
Center**  
Khaled Ebn Al Walid St.  
Bldg. No. 47, P.O.BOX 13520,  
Damascus, SYRIA  
TEL: (011) 223-5384

## TURKEY

**Barkat muzik letleri ithalat  
ve ihracat Ltd Sti**  
Siraselviler Caddesi Siraselviler  
Pasaji No:74/20  
Taksim - Istanbul, TURKEY  
TEL: (0212) 2499324

## U.A.E.

**Zak Electronics & Musical  
Instruments Co. L.L.C.**  
Zabeel Road, Al Sheroq Bldg.,  
No. 14, Grand Floor, Dubai, U.A.E.  
TEL: (04) 3360715

## NORTH AMERICA

### CANADA

**Roland Canada Music Ltd.  
(Head Office)**  
5480 Parkwood Way Richmond  
B. C., V6V 2M4 CANADA  
TEL: (604) 270 6626

**Roland Canada Music Ltd.  
(Toronto Office)**

170 Admiral Boulevard  
Mississauga On L5T 2N6  
CANADA  
TEL: (905) 362 9707

### U. S. A.

**Roland Corporation U.S.**  
5100 S. Eastern Avenue  
Los Angeles, CA 90040-2938,  
U. S. A.  
TEL: (323) 890 3700

As of April 1, 2003 (Roland)

## Free Manuals Download Website

<http://myh66.com>

<http://usermanuals.us>

<http://www.somanuals.com>

<http://www.4manuals.cc>

<http://www.manual-lib.com>

<http://www.404manual.com>

<http://www.luxmanual.com>

<http://aubethermostatmanual.com>

Golf course search by state

<http://golfingnear.com>

Email search by domain

<http://emailbydomain.com>

Auto manuals search

<http://auto.somanuals.com>

TV manuals search

<http://tv.somanuals.com>