

# PARAPHONIC Guitar Synthesizer

## Synthesizer GR-500 INSTRUCTIONS

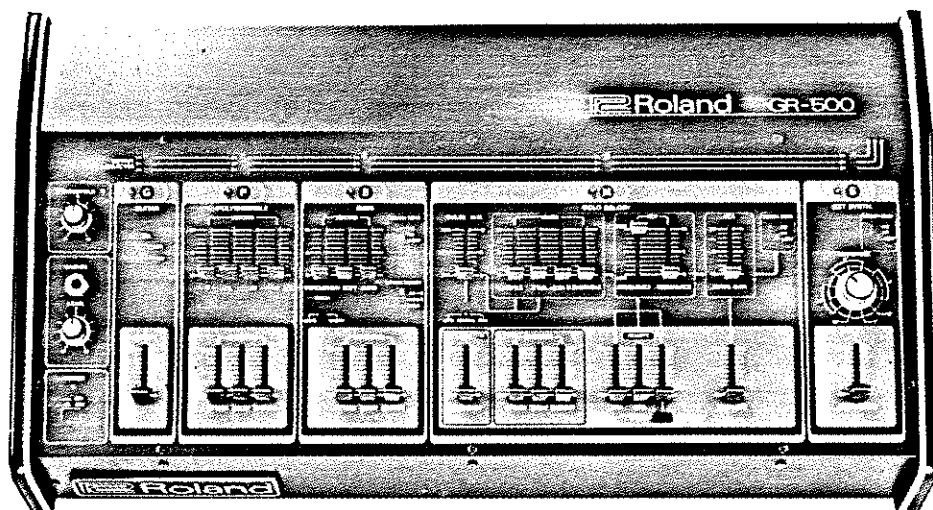

The five separate sections which comprise the Roland GR-500 are the Guitar, Polyensemble, Bass, Solo Melody, and External Synthesizer Sections. The External Synthesizer Section is essentially an interface to any of the popular brands of synthesizer.

Each of the five sections of the GR-500 may be played individually or in any combination. Each section offers unlimited freedom of expression and unsurpassed controllability. Roland has created a name for this new level of performance capability. It is the word "paraphonic," derived from "parallel" plus "phonic."

Nearly all of the controls on both the Guitar Controller (Guitar) and the GR-500 Synthesizer are grouped and labeled to fall within these five sections.

Output from each of the five sections of the GR-500 Guitar Synthesizer can be channeled separately or in combination, through any of three independent output jacks. Remarkable flexibility is afforded by this capability of connecting each output to the amplifiers most appropriate for its source. It is also possible to channel all sounds through a single amplifier by using the MIX OUT jack, which contains the outputs of all five sections.

A headphone jack also contains the sound from all five sections, and enables you to perform or practice privately.

# Synthesizer GR-500 CONTROLS & FUNCTIONS

## CONTROL PANEL

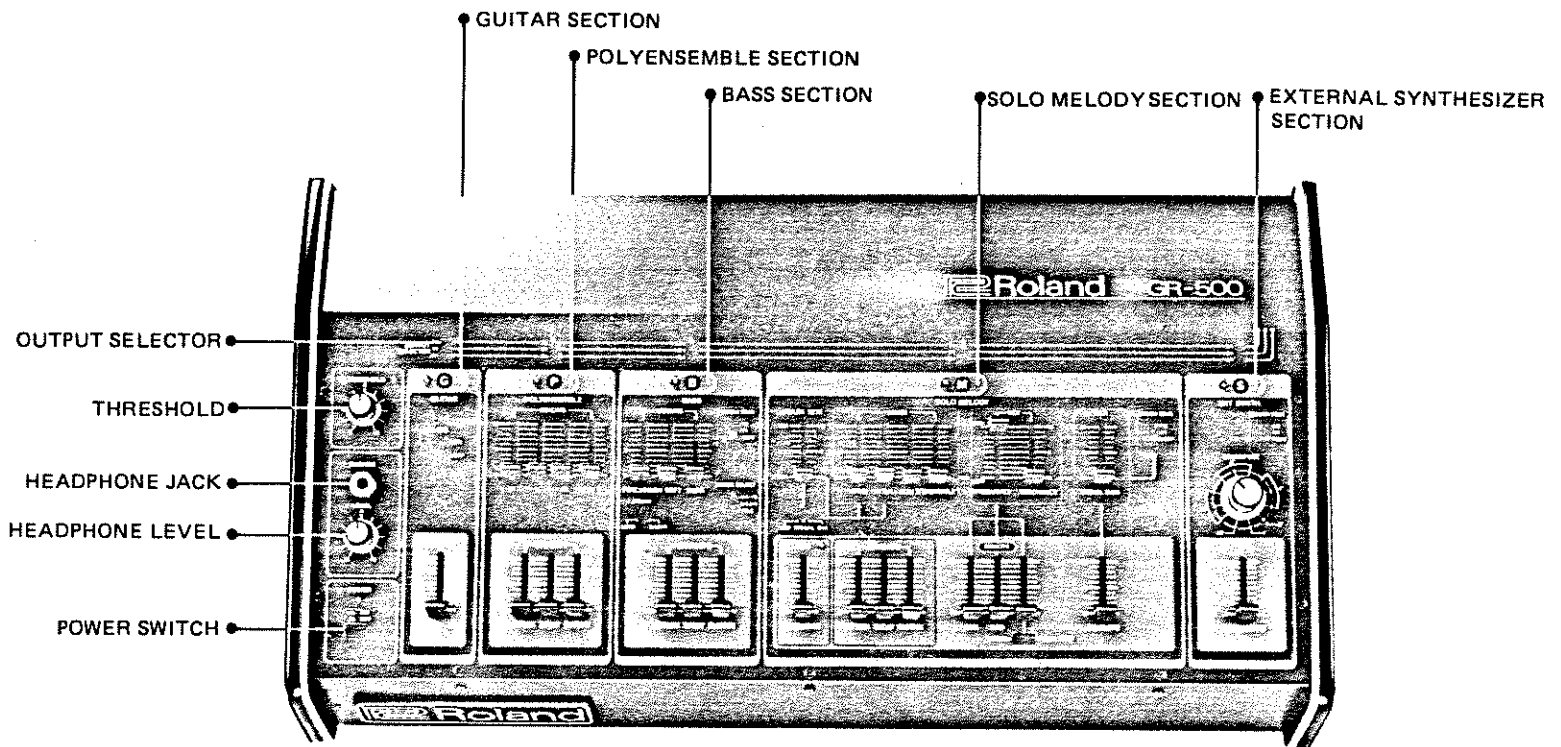

## REAR PANEL

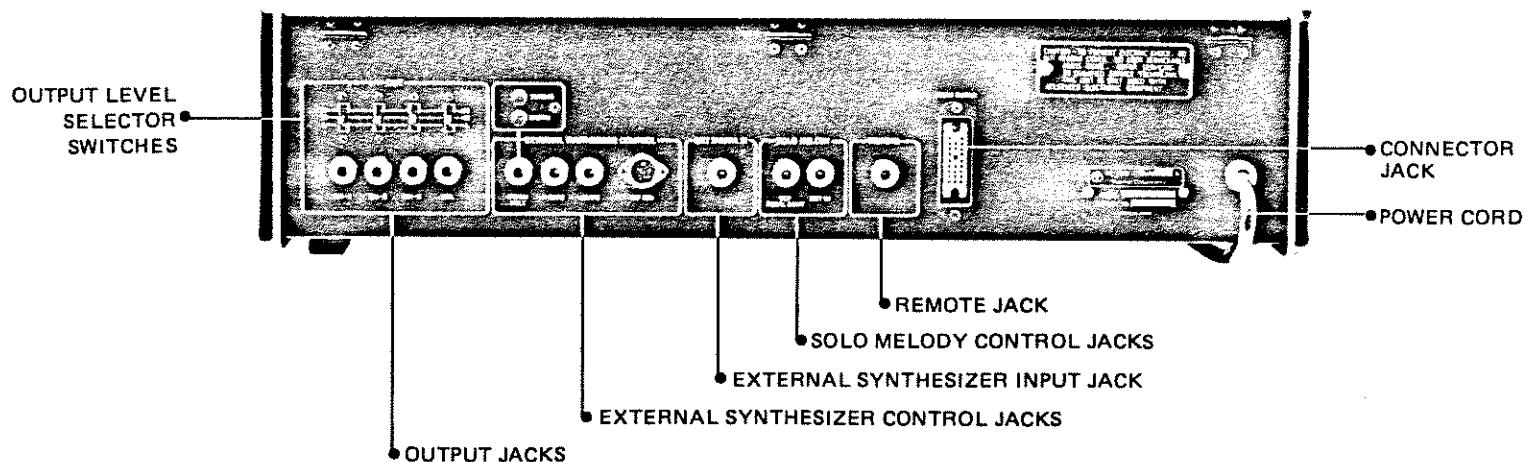

### **OUTPUT SELECTOR SWITCH**

This three-position selector switch corresponds to three separate output jacks on the rear panel. It is used to assign its particular section to any of these three output jacks. Note that output at the MIX and HEADPHONE jacks is a mixture of the three output channels.

### **THRESHOLD**

To assure optimum performance results regardless of individual playing techniques, this control helps compensate for variations of picking, and differences in intensity of picking.

### **HEADPHONE JACK/LEVEL**

Receives headphones and allows adjustment of headphone volume level.

### **GUITAR SECTION**

Responsible for providing the sound of a conventional electric guitar, this section features an equalizer on/off switch (EQ) and an equalizer frequency control (EQ. FREQ.). When the guitar volume of the Guitar Controller is set at the proper level, an LED indicator for the Guitar Section illuminates to signal that guitar sound may be produced.

### **POLYENSEMBLE SECTION**

This totally polyphonic section features four voicing mixer controls plus envelope controls for ATTACK, DECAY, and SUSTAIN. When the volume of the Guitar Controller is set at the proper level, an LED indicator for this section illuminates to signal that Polyensemble sound may be produced.

### **BASS SECTION**

The following controls are provided in this section:

- (1) Three voicing slide levers, for PERCUSSION, SOFT, HARD.
- (2) Three envelope slide levers, for ATTACK, DECAY, SUSTAIN.
- (3) Selector switch for PERCUSSION DECAY LONG/SHORT
- (4) Three-position string selector
- (5) Three-position TOUCH SENS selector switch.

This section employs a last-note-priority system in which the ultimate note sounded corresponds with the sound of the last string played. (See page 10.) When the volume of the Guitar Controller is set at the proper level, an LED indicator illuminates for this section to signal that Bass Section sound may be produced.

### **SOLO MELODY SECTION**

Having a basic function similar to that of a conventional synthesizer module, this section employs a last-note-priority system in which the ultimate note sounded corresponds with the sound of the last string played. When the volume of the Guitar Controller is set at the proper level, an LED indicator illuminates for this section to signal that Solo Melody sound may be produced.

LFO modulation of the VCF in this section can be remotely controlled by an on/off switch located on the guitar.

### **EXTERNAL SYNTHESIZER SECTION**

To greatly increase the performance possibilities of the Guitar Synthesizer, an external synthesizer can be controlled through this section. Examples of Roland synthesizers recommended for this purpose are the System 700, the System 700 Laboratory Synthesizer; the System 100: Basic Unit 101 and/or Expander 102; and the SH-5. Further, since both plus and minus gate voltages are available at the rear panel of the GR-500, most other brands of synthesizers may be used also.

### **OUTPUT JACKS**

Output signals can be taken directly from three separate channels, as determined by the settings of the Output Selector Switches on the control panel. This means you can select the amplifier and speaker system best suited for each output, i.e., a bass amplifier for the Bass Section.

You will find that each output jack is equipped with a three-step output level selector switch. This facilitates the connection of amplifiers of nearly any type and makes studio recording more convenient.

### **EXTERNAL SYNTHESIZER CONTROL JACKS**

Provides for the control of external synthesizers.

### **EXTERNAL SYNTHESIZER INPUT JACK**

This jack receives the audio output of an external synthesizer so that its volume can be controlled by the Guitar Controller.

### **SOLO MELODY CONTROL JACKS**

#### **VCF Pedal Control Jack**

By connecting a volume pedal, such as the Roland FV-2 to this jack, VCF cutoff frequency can be controlled to obtain wow-like effects.

#### **External Source Input Jack**

By connecting an ordinary electric guitar output to this jack, the VCF and VCA of the Solo Melody Section can be controlled to produce a great variety of sounds. Highly effective variations can be produced by directing modulation (LFO, VCF pedal control) to the VCF cutoff frequency.

### **REMOTE JACK**

Connection between this jack and the footswitch jacks of the various effects found on most amplifiers will allow these effects to be remotely controlled at the guitar, using the Remote Switch.

### **FROM GUITAR**

This connector links the Guitar Controller and the GR-500 Synthesizer.

### **TUNING/WIDTH**

These controls are factory adjusted and should be altered only by a qualified service technician.

## ASSEMBLING

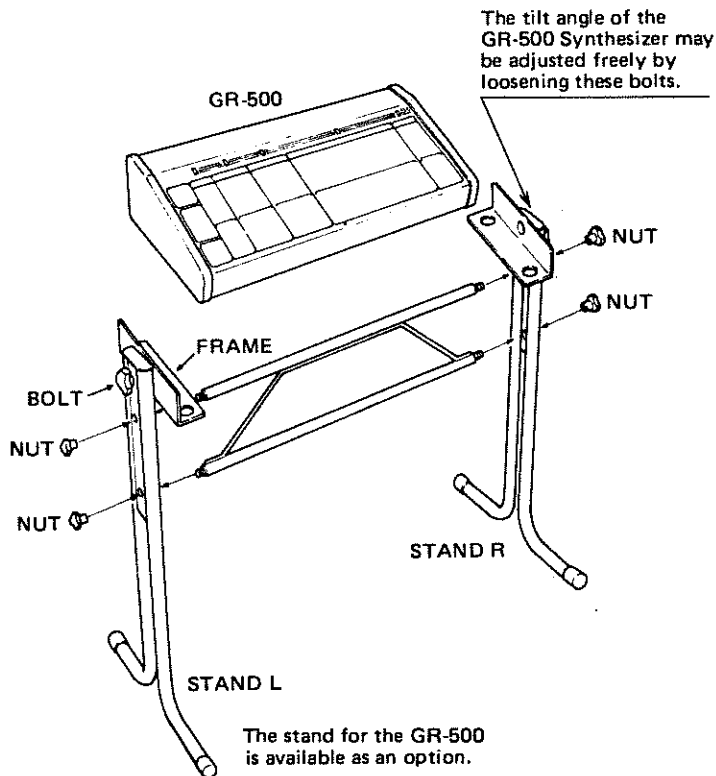

## CAUTIONS FOR USING SYNTHESIZERS

Avoid using the synthesizer in very high or low temperature locations. Also keep it away from heaters and coolers since this type of equipment tends to affect circuit and pitch stability.

Avoid using synthesizers in very dusty or high-humidity places.

Use a soft cloth when wiping the GR-500 Synthesizer Control Panel. Avoid using thinners and/or solvents.

Salt can damage the exteriors as well as the internal circuitry of synthesizers. Using the Roland Guitar Synthesizer while or immediately after eating salty snacks can cause problems with conductivity of jacks.

## CONNECTING THE GR-500 SYNTHESIZER AND THE GUITAR CONTROLLER

### BASIC CONNECTION METHODS

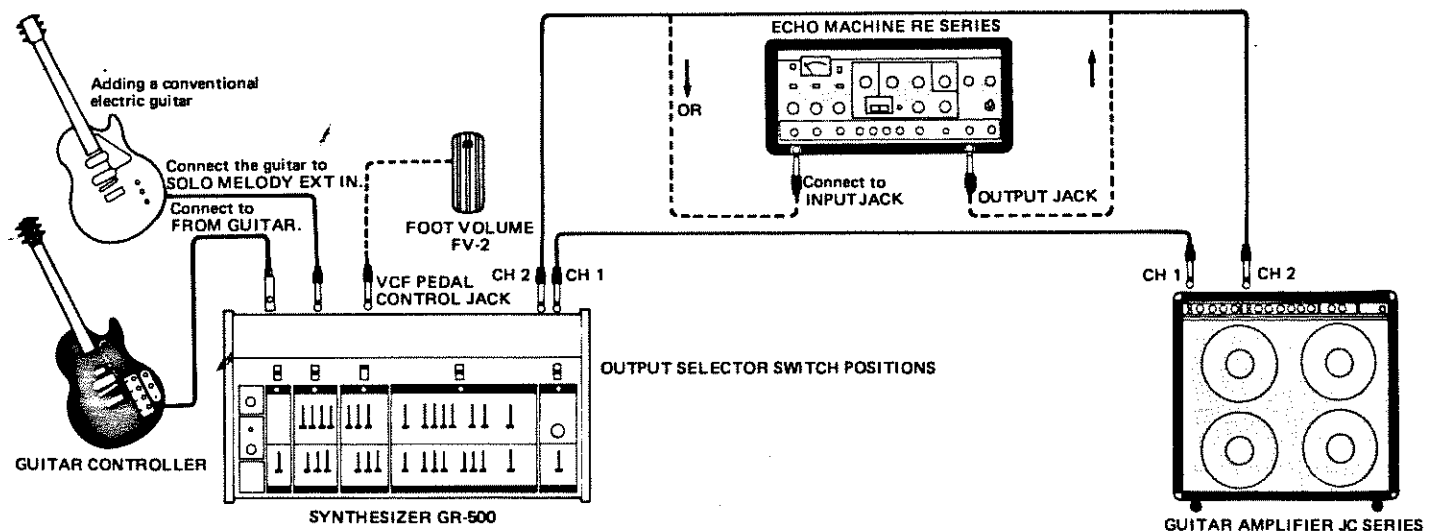

### USING A SINGLE ROLAND JAZZ CHORUS AMPLIFIER

Set Bass Section Output Selector Switch at "1" and connect Output Jack "1" directly to the "Channel 1" input of the amplifier.

Set Output Selector Switches of the other sections to "2" and connect the Output Jack "2" directly to "Channel 2" input of the amplifier.

Considerable variety of sound can be achieved by employing the Reverb and Chorus effects of the JC Amplifier. In addition, effect devices may be used between the guitar synthesizer and the amplifier.

# CONNECTION METHOD VARIATIONS

## VARIATION 1

### • USING A GUITAR AMPLIFIER AND A BASS AMPLIFIER

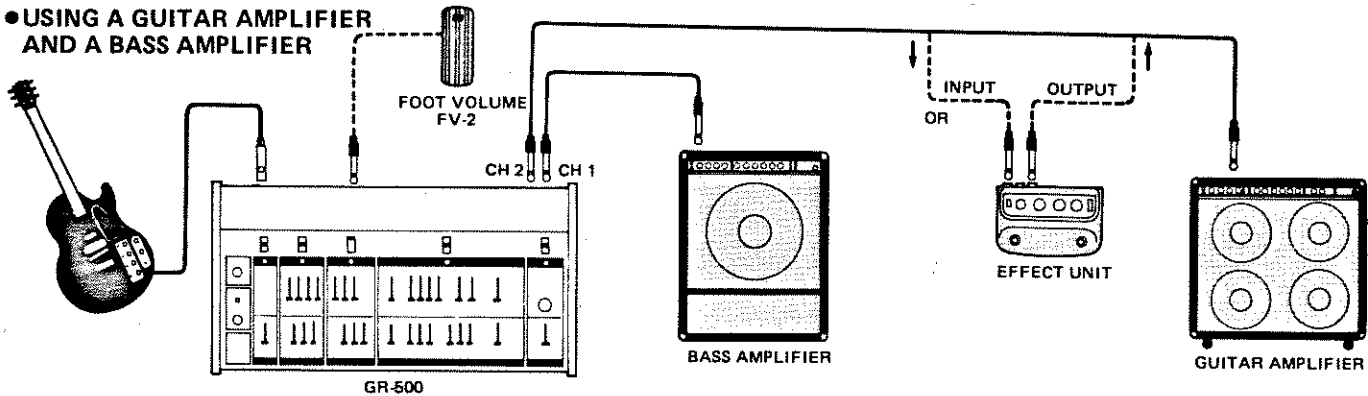

Set Bass Section Output Selector Switch at "1" and connect Output Jack "1" to bass amplifier.  
Set switches of other sections to "2" and connect Output Jack "2"

to guitar amplifier.  
By adding effect units between the GR-500 and the guitar amplifier, variations of sound are possible.

## VARIATION 2

### • STUDIO RECORDING

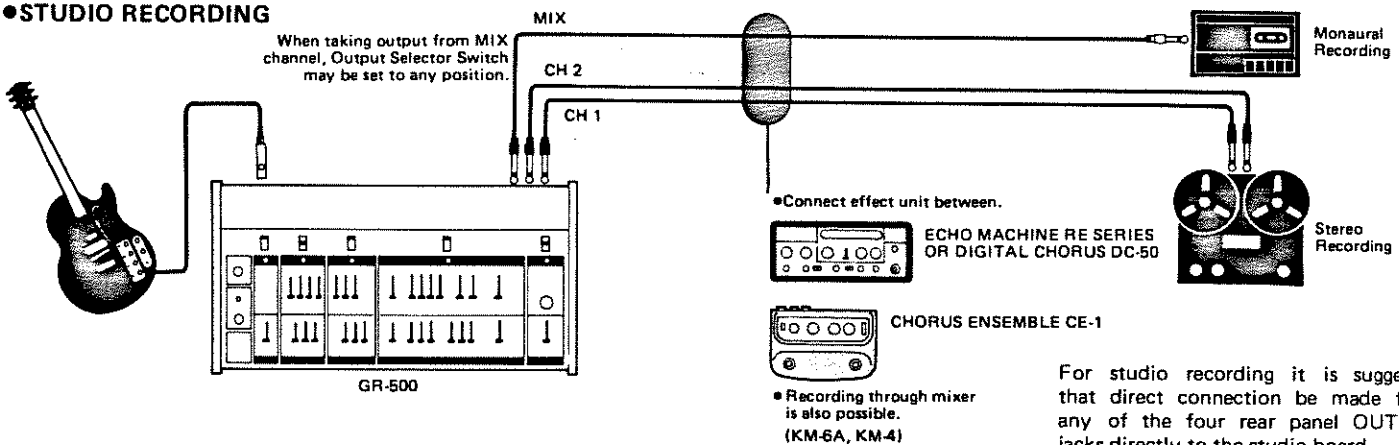

For studio recording it is suggested that direct connection be made from any of the four rear panel OUTPUT jacks directly to the studio board.

## VARIATION 3

### • CONNECTING EXTERNAL SYNTHESIZERS

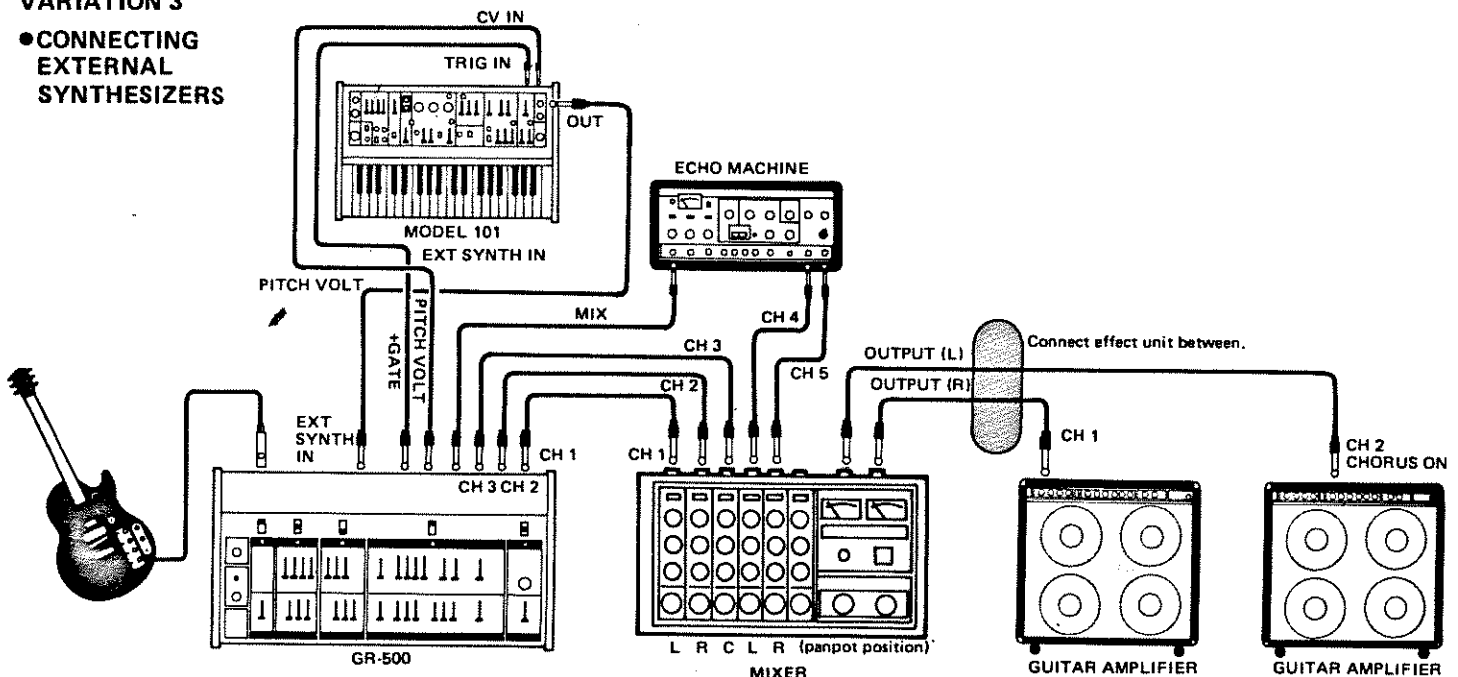

# THRESHOLD

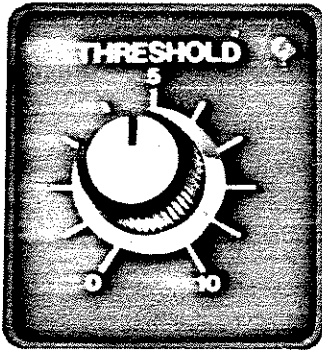

The Threshold Control functions to compensate for individual differences in performance technique, or other variables. Examples of these differences are pick playing as opposed to finger playing, picking intensity, hardness of the pick, picking region, string gauge, and bridge height (clearance between string and divided pickup).

Because of these factors, trigger failure can occur. This results in intermittent sounding of notes.

The Threshold Control is used to adjust trigger sensitivity.

## OPERATING THRESHOLD

### 1

Adjust the bridge and other parts of the Guitar Controller so that you can play it comfortably. Clearance between the humbucking pickup and the strings can be adjusted freely. The clearance between the divided pickup and the strings should be adjusted with the 22nd fret held down: approximately 1.0mm for the first string and approximately 1.5mm for the sixth string.

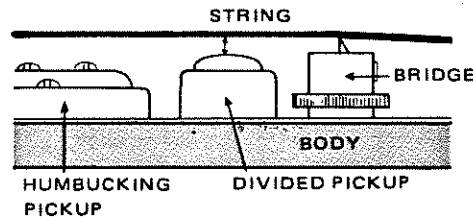

\* As clearance between divided pickup and string gets smaller, sensitivity increases; and vice versa.

### 2

When the Threshold Control is set at "0", trigger failure and missed notes will result unless a considerably strong picking technique is used. When set to "10", sound is produced with light picking or even finger playing. But if a strong picking technique is used, intermittent sounding of tones will again occur.

As you play a variety of single tones and chords, turn the Threshold Control clockwise, gradually, to determine the optimum setting for consistent triggering of tones.

It is important to play both single notes and chords when making this adjustment.

# GUITAR SECTION

The Guitar Section produces the sound of conventional electric guitars. By combining the exclusive humbucking pickup on the Guitar Controller with a unique equalizer system, however, a much greater variety of tone colors can be created.

Further, by careful adjustment of the tone controls of external amplifiers and effect devices used in conjunction with the GR-500, the Guitar Section alone is capable of producing a variety of sound far beyond that of conventional guitars.

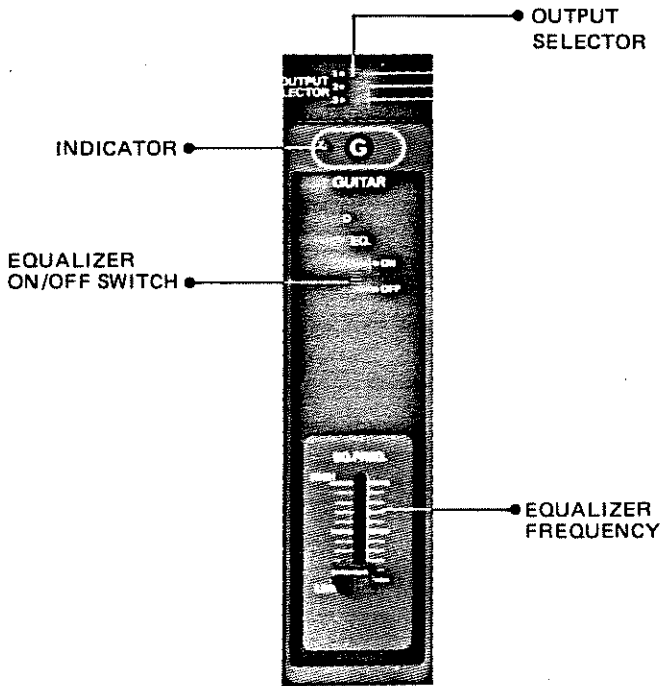

## EQUALIZER ON/OFF SWITCH

When this switch is on, the equalizer of the Guitar Section is activated. When off, the Guitar Controller sound will still be produced, but the equalizer is bypassed.

## EQUALIZER FREQUENCY

Operating as a "preset tone control," this adjustment serves a completely different function than that of the equalizer of the Guitar Controller. Equalizer frequency is a kind of band pass filter; its peak frequency may be changed freely by the frequency control for variations of tone colors.

When the control is set at HIGH, the sound is hard and metallic. When set at LOW, more "bottom" is heard.

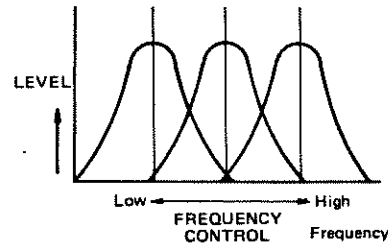

## TUNING

Tuning the Guitar Controller is accomplished in the same manner as with conventional guitars. BE SURE THE EQUALIZER IS TURNED OFF.

## CONNECTING ATTACHMENTS AND EFFECT DEVICES

When you use effect and sound modification devices in conjunction with the Guitar Section, connect these devices directly to the desired Output Jack on the rear panel. Then set the Output Selector Switch of the Guitar Section to correspond with the channel you have selected.

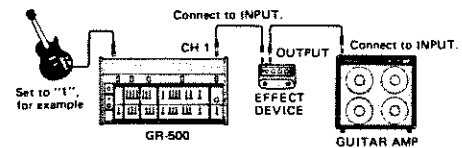

## OPERATING THE GUITAR SECTION

**1 GR-500 Guitar Controller**  
After connecting cords, set all knobs and switches to the "0" or OFF position.

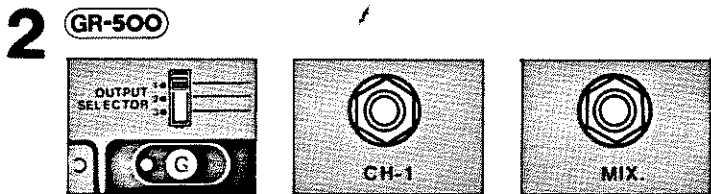

Connect an external amplifier or effect device to one of the output jacks on the rear panel. Locate the Output Selector Switch above the Guitar Section on the control panel, and set this switch to correspond with the output jack you have chosen on the rear panel. When the output selector is set to "1", for example, the output signal appears at the CH 1 Output Jack on the rear panel. Note that if you have chosen to use the MIX Output Jack, the Output Selector Switch may be set at any position.

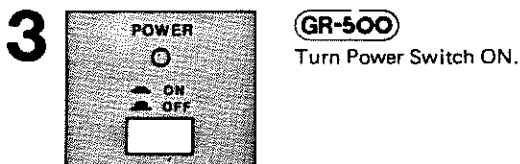

**4 Guitar Controller**  
Set GUITAR/DUAL/SYNTHESIZER Selector Switch to GUITAR. Set guitar Volume and Master Volume to proper levels.

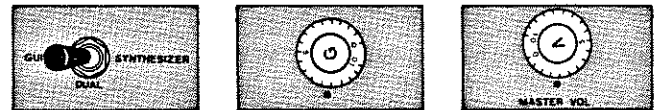

**5 GR-500**  
Be sure the LED function indicator for the Guitar Section illuminates. The Guitar Section is now ready to produce sound.



**6**  
Set the equalizer on/off switch to the desired position. When set to ON, the equalizer is active.

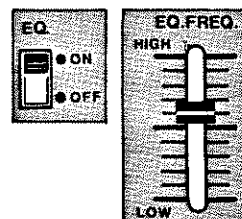

**7**  
Set Guitar Tone Control and Equalizer Mode Selector to the desired position.

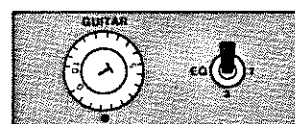

# POLYENSEMBLE SECTION

The totally polyphonic Polyensemble Section offers the ability to simultaneously produce a combination of tones such as a chord. With four voicing mixers and a three-control envelope generator, no special playing technique is required to create startling en-

sembles of sound such as a brass chorus, or a string section. All controls for this section are grouped together under "P" on the control panel.

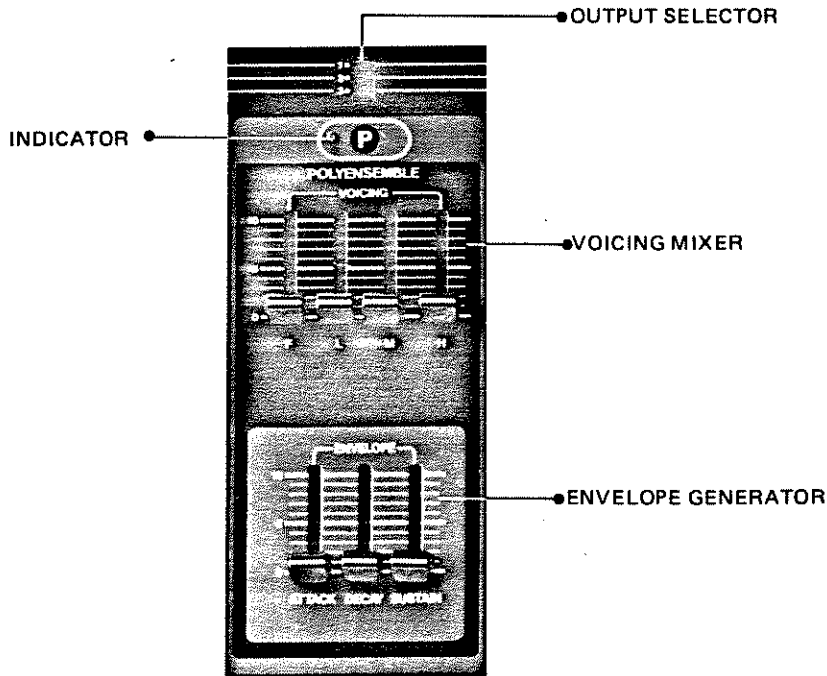

## VOICING MIXER

These are slider controls which determine the tone quality of the Polyensemble Section. It contains four sound sources: "F" (fundamental); "L" (low); "M" (middle); and "H" (high). These sounds can be attained individually or in any combination.

## ENVELOPE GENERATOR

Three slider controls function to determine the manner in which the sound rises and fades.

The lever on the left controls ATTACK, or the time required for the sound to rise to its full intensity.

The center lever governs DECAY time, or the time required for the sound to decay to a "predetermined" level.

The setting of the lever on the right determines the SUSTAIN level, or the predetermined volume to which the sound will ultimately decay.

## OPERATING THE POLYENSEMBLE SECTION

### 1 GR-500

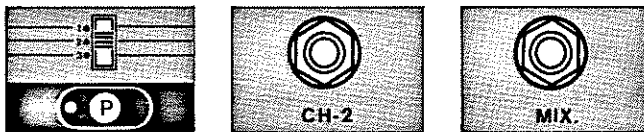

Connect an external amplifier or effect device to one of the Output Jacks on the rear panel. Locate the Output Selector Switch above the Polyensemble Section on the control panel, and set this switch to correspond with the output jack you have chosen on the rear panel. When the Output Selector is set to "2", for example, the output signal appears at the CH 2 Output Jack on the rear panel. Note that if you have chosen to use the MIX Output Jack, the Output Selector Switch may be set at any position.

### 2



#### Guitar Controller

Set the GUITAR/DUAL/SYNTHESIZER Selector Switch to SYNTHESIZER.

### 3

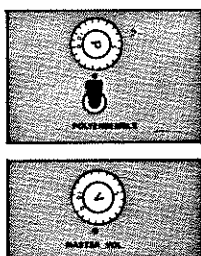

#### Guitar Controller

Set the Polyensemble Section ON/OFF switch to ON and raise the Volume and Master Volume controls to their proper levels. FOR THE TIME BEING, KEEP ON/OFF SWITCHES OF THE OTHER SECTIONS OFF.

### 4



### GR-500

Be sure the LED indicator for the Polyensemble Section illuminates. The Polyensemble Section is now ready to produce sound.

### 5

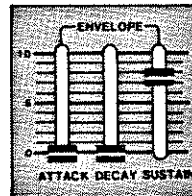

Set the SUSTAIN level control of the envelope generator to the desired position.

### 6

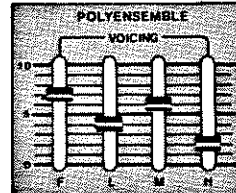

Set the slide lever controls of the voicing mixer to their desired positions.

### 7

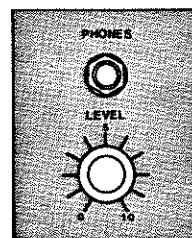

When using headphones, connect them to the Headphone Jack on the control panel and adjust the Headphone Volume Level.





**WHAT IS AN ENVELOPE GENERATOR?**

Three of the essential qualities by which we distinguish a sound are pitch, timbre, and envelope (rise and fade of a sound). Pitch, of course, is represented by frequency. Timbre is determined by the harmonic content, or pattern of overtones present. Envelope

pertains to the rate and intensity with which a tone starts, continues and stops. In the GR-500, various envelope patterns are created by ATTACK time, DECAY time, and SUSTAIN level.

**ATTACK TIME**

In analyzing the particular envelope of a plucked guitar string (Fig. P-1), it takes about 0.02 seconds from the instant the string is picked until the string vibration (and therefore its volume level) reaches maximum intensity. This is the attack time.

GUITAR STRING ENVELOPE P-1.

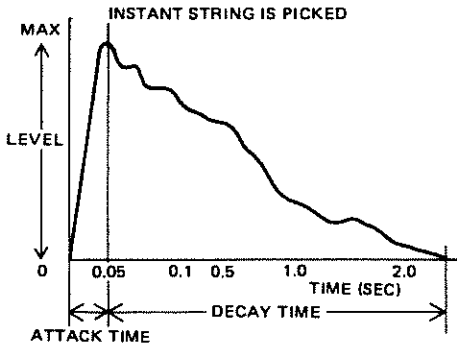

When the ATTACK slide lever is raised, no sound will be produced the instant the string is picked; instead, the sound level will gradually increase to maximum. On reaching its peak intensity, it will instantly fade out. (see Fig. P-2).

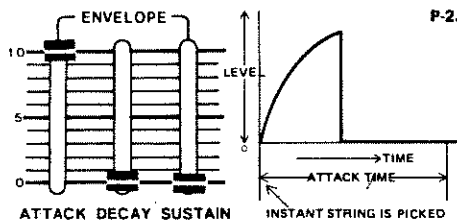

**DECAY TIME**

Upon completion of the ATTACK phase of the envelope, or the moment the sound has reached its peak level, the DECAY phase begins. (Fig. P-1) DECAY time, or the time required for the sound to decay, is controlled by the center lever. As this lever is raised, DECAY time . . . the time required for the sound to fade . . . is increased and an envelope close to that of a conventional guitar is obtained (see illustration in Fig. P-3).

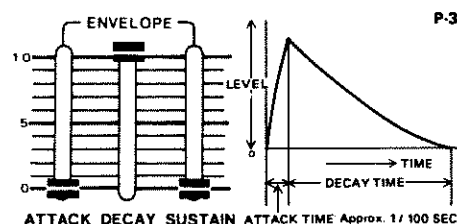

**SUSTAIN LEVEL**

The sound produced by guitar strings will fade away after a certain length of time, even if the string is picked intensely (Fig. P-1). This is not true in the case of such as an organ where sound is maintained as long as a key is held down (Fig. P-4). This "continuing" of a sound is referred to as SUSTAIN, and the volume level at which the tone continues to sound is called the SUSTAIN LEVEL.

Raising the SUSTAIN Lever increases the volume level at which the sound is maintained during the SUSTAIN phase of the envelope. Note that when the SUSTAIN lever is raised all the way, sound will not decay; therefore, adjustment of the DECAY lever has no effect on the envelope pattern.

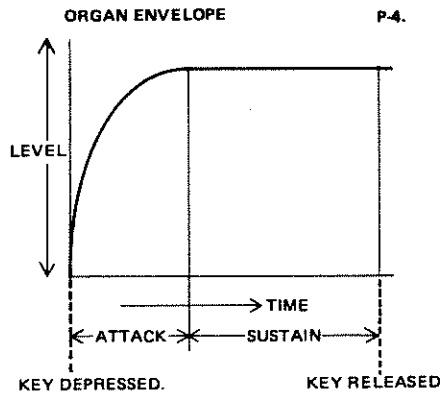

In the case of the guitar synthesizer, ATTACK time starts the instant the string is picked. When ATTACK reaches its peak, DECAY time begins: And the sustain level (setting of the SUSTAIN lever) determines the level to which the decay falls. Notice here that among these three envelope controls, ATTACK and DECAY control time; only SUSTAIN relates to level (volume).

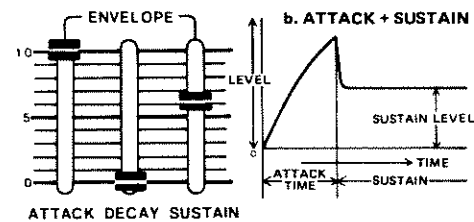
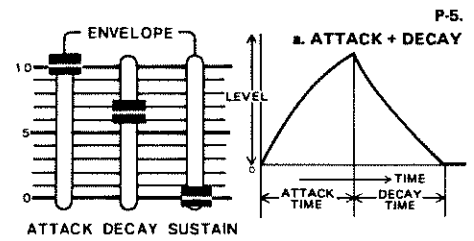
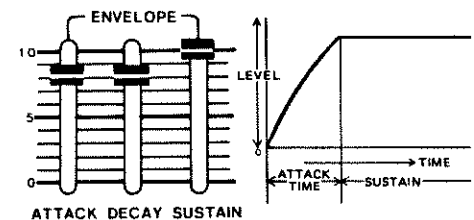
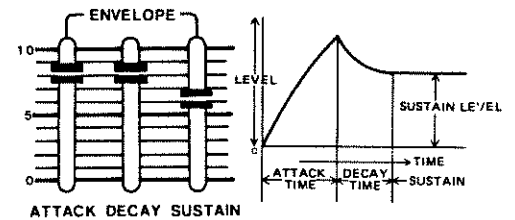
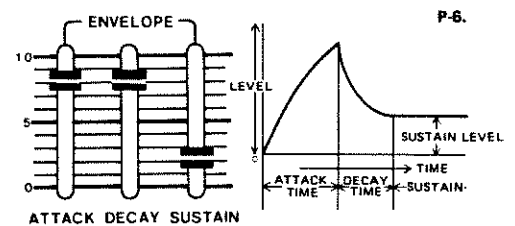

Fig. P-6 shows various settings of SUSTAIN level, with ATTACK and DECAY time set at fixed positions.



# BASS SECTION

Guitarists everywhere have strongly desired to be able to use their instruments to play bass. The Roland GR-500 Guitar Synthesizer makes this dream a reality. And it does so with greater versatility and flexibility than you might imagine. Through its envelope generator and percussion controls, the Bass Section offers unlimited performance possibilities. Its "last-note-priority" system enables you to use the Bass Section to play duets. Last-

note-priority means that the bass note ultimately heard corresponds with the last string picked.

The Bass Section is activated and its volume controlled by an on/off switch and a volume control located on the guitar controller. The Bass Section may be played in combination with any other sections of the guitar synthesizer.

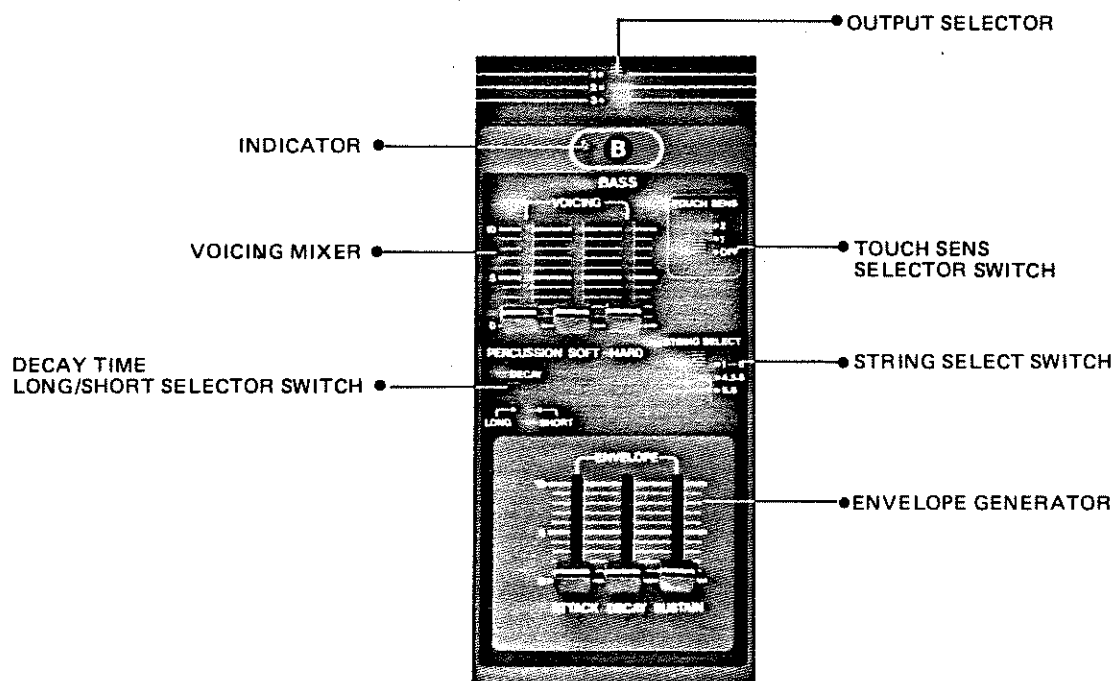

## ENVELOPE GENERATOR

These slide levers, ATTACK, DECAY, and SUSTAIN, operate in the same manner as those of the Polyensemble Section.

## VOICING MIXER

These slide levers determine the tone quality of the bass sound. Three variations of sound are offered; PERCUSSION, SOFT and HARD. They may be used individually, or in any combination.

The percussion control is provided with a Decay Time LONG/SHORT Selector Switch to enable decay time to be altered.

## TOUCH SENS SELECTOR SWITCH

This switch controls the relationship between intensity of sound produced and intensity of picking.

At the OFF position, volume is constant, regardless of picking intensity.

At the "1" position, picking intensity only slightly affects volume.

At the "2" position, picking intensity affects volume in the same manner as a conventional guitar.

## STRING SELECT SWITCH

This switch selects the strings which will produce bass sound. When used in combination with other sections, this feature produces highly effective performance results.

"1-6". . . . . All strings used; last string picked will produce bass sound.

"4-5-6" or "5-6". . . . . The last string picked in the indicated group will produce the bass sound, the others will not.

## OPERATING THE BASS SECTION (FOR BASS SOUND ONLY)

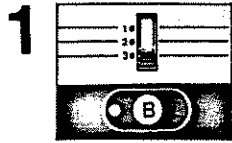

**GR-500**

Connect an external amplifier or effect device to one of the output jacks on the rear panel. Locate the Output Selector Switch above the Bass Section on the control panel, and set this switch to correspond with the output jack you have chosen on the rear panel. When the Output Selector is set to "3", for example, the output signal appears at the CH 3 Output Jack on the rear panel. Note that if you have chosen to use the MIX Output Jack, the Output Selector Switch may be set at any position.

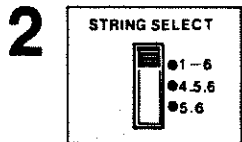
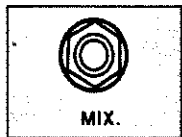

Set the String Select Switch to "1-6". All six strings will then produce bass sound.

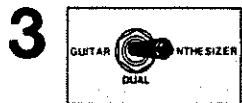

**Guitar Controller**

Set the GUITAR/DUAL/SYNTHESIZER Selector Switch to SYNTHESIZER.

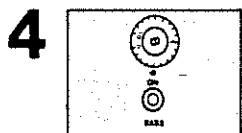

Set the Bass Section ON/OFF Switch to ON and adjust the Volume and Master Volume Controls to the desired levels. KEEP ON/OFF SWITCHES OF OTHER SECTIONS AT OFF.

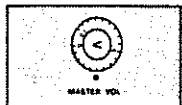

**GR-500**

Be sure the LED indicator for the Bass Section is illuminated. The Bass Section is now ready to produce sound.

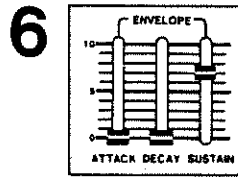

Set the SUSTAIN level control of the envelope generator to the desired position.

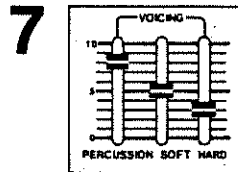

Adjust the PERCUSSION, SOFT, and HARD slide levers to the positions you wish.

Set the Decay Time LONG/SHORT Select Switch to the position you prefer.

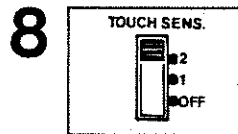
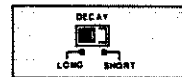

Set the TOUCH SENS Selector Switch to the position you prefer.

## TO PRODUCE SOUND IN COMBINATION WITH OTHER SECTIONS

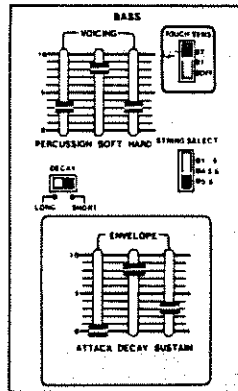

Set switches and controls as illustrated and adjust the Guitar and Polyensemble Sections as desired.

The Bass Section produces bass sound from the fifth and sixth strings only.

From the first to the fourth strings, a mixture of guitar and polyensemble sound is produced.

Use the MIX Output Jack.

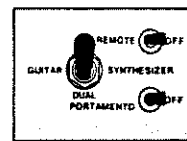

**Guitar Controller**

Set GUITAR/DUAL/SYNTHESIZER Selector Switch to DUAL (center).

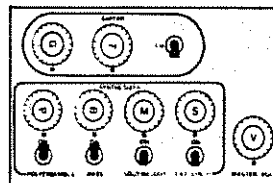

Set ON/OFF switches of Polyensemble and Bass Sections to ON and adjust volume controls to proper levels. Also, adjust volume, tone and equalizer controls of the Guitar Section to the positions of your choice.

## LAST-NOTE-PRIORITY SYSTEM

When playing only the Bass Section, you will note that only single notes are produced. The note ultimately sounding corresponds with the last string picked.

To familiarize yourself with this system, set controls and adjustments for bass sound only. Set the String Select Switch to "1-6." Play from the sixth string to the first string slowly. You will discover that the unique last-note-priority system acknowledges the fact that the natural progression of sound production in the guitar

is from the sixth string to the first.

Step by step, here is what happens. You pick the sixth string first. Then, the instant you pick the fifth string, the sixth string ceases to sound. The instant you pick the fourth string, the fifth string stops sounding, and so forth.

Try to play the sixth and the fifth strings simultaneously with one down stroke. The sixth string will not sound; you will hear only the sound of the fifth string. Although the two strings are played almost simultaneously, the

pick strikes the sixth string on the down stroke first, and then the fifth string. There is a slight delay between the picking of the sixth and fifth strings and this is where the last-note-priority system takes effect. The result is that you will not hear the note that corresponds with the sixth string.

This same last-note-priority system is incorporated in the Bass, Solo Melody, and External Synthesizer Sections.

# SOLO MELODY SECTION

The Solo Melody Section is the main section of the Roland Guitar Synthesizer. It is provided with standard controls and functions similar to those of module synthesizers. As in the Bass Section, the Solo Melody Section incorporates the last-note-priority system. With a 24dB per octave VCF, this exceptionally versatile

section can produce virtually unlimited variations of both instrumental sounds and unique, electronic sounds characteristic of synthesizers.

Sound created by this section may be combined with any of the other sections of the GR-500 Guitar Synthesizer.

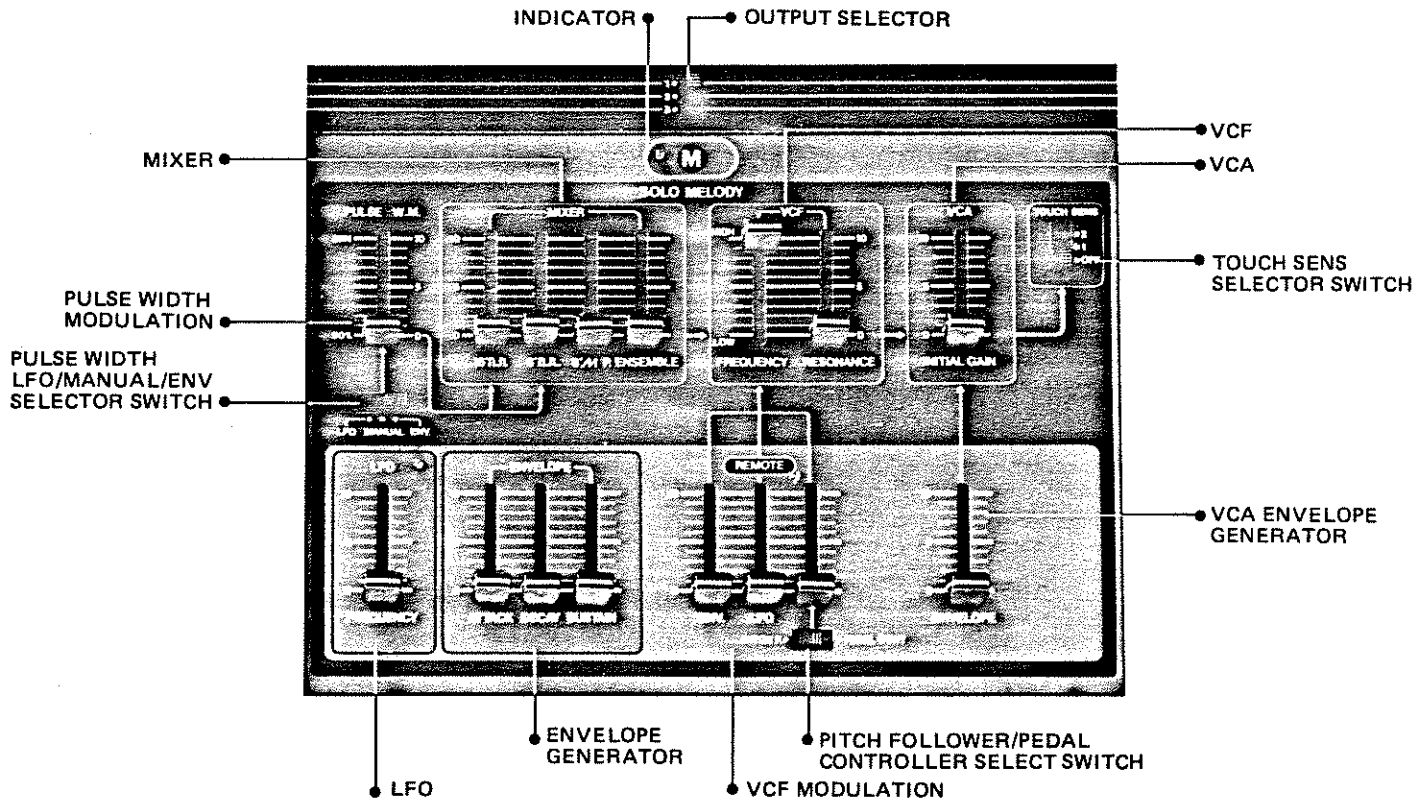

## OPERATING THE SOLO MELODY SECTION

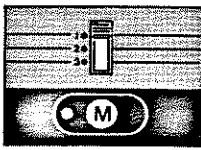
**1**  **GR-500**  
Connect an external amplifier or effect device to one of the output jacks on the rear panel. Locate the Output Selector Switch above the Solo Melody Section on the control panel, and set this switch to correspond with the output jack you have chosen on the rear panel. When the Output Selector is set to "1", for example, the output signal appears at the CH 1 Output Jack on the rear panel. Note that if you have chosen to use the MIX Output Jack, the Output Selector Switch may be set in any position.

**2**  **Guitar Controller**  
Set the GUITAR/DUAL/SYNTHESIZER Selector Switch to SYNTHESIZER.

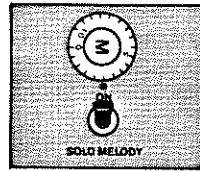
**3**  **Guitar Controller**  
Set Solo Melody Section ON/OFF switch to ON and raise the Volume and Master Volume controls to their desired levels. FOR THE TIME BEING, KEEP ON/OFF SWITCHES OF THE OTHER SECTIONS OFF.

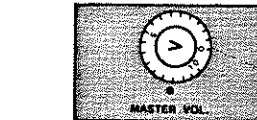

**4**  **GR-500**  
Be sure the LED indicator for the Solo Melody Section is illuminated. The Solo Melody Section is now ready to produce sound.

Operating methods for each of the controls of the Solo Melody Section follow. It is recommended that you experiment with these controls in the same order as they are presented in this manual.

## MIXER

These slide levers function to mix the four Solo Melody sound sources: 16' and 8' square waves including pulse width modulation (□), 8' sawtooth wave (∧), and polyensemble.

The Polyensemble control allows the output sound of the Polyensemble Section to be processed by the Solo Melody Section. If you don't want the Polyensemble Section Envelope Generator to affect this processing, set the Polyensemble Section Envelope Generator ATTACK control all the way down and the SUSTAIN control all the way up. The DECAY control may be set anywhere.

## LFO (Low Frequency Oscillator)

This oscillator generates low frequencies in the range of 0.15 to 25Hz. Instead of generating audible sound, it generates a signal that functions as a control voltage for the VCF, VCA, and pulse width modulation. In the case of the GR-500, this signal is a sine wave (∩). As the LFO lever is raised, modulation speed increases. The LED indicator on the LFO flashes at the same rate as the rate of modulation.

## PULSE WIDTH MODULATION

This slide lever is used to control the pulse width of 16' and 8' sounds originating in the mixer section.

The pulse width modulation can be controlled (1) manually; (2) by the envelope generator; and (3) by the LFO (low frequency oscillator).

### (1) Manual Control of Pulse Width Modulation

Set the PULSE WIDTH MODULATION Slide Lever to "0" (50%) and set the PULSE WIDTH MODULATION Selector Switch to MANUAL. Select 16' [□] or 8' [□] on the mixer. Raise the MIXER Slide Lever and the PULSE WIDTH MODULATION Slide Lever. The waveform shown in Fig. M-1 will appear.

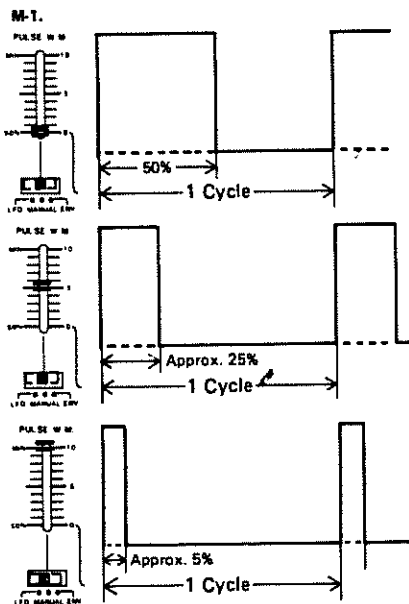

### (2) Envelope Control of Pulse Width Modulation

Set the Modulation Selector Switch to ENV. Instead of manual operation of the slide levers, the envelope curve generated by the envelope generator functions to control the sound. In this case, the PULSE WIDTH MODULATION Slide Lever adjusts the intensity of modulation.

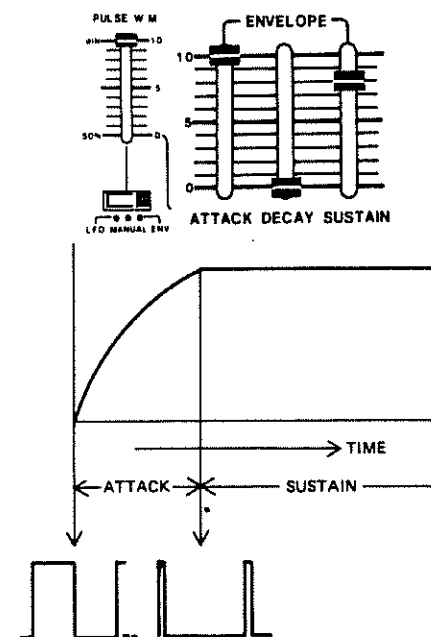
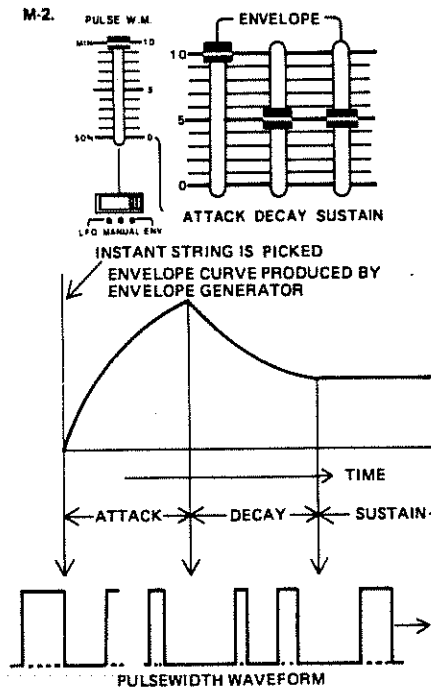

### (3) LFO (Low Frequency Oscillator) Control of Pulse Width Modulation

Set the Modulation Selector Switch to LFO. The pulse width is controlled by the LFO and the PULSE WIDTH MODULATION Slide Lever adjusts the intensity of modulation. When the LFO Frequency Slide Lever is raised, pulse width change speed increases and chorus effects are obtained.

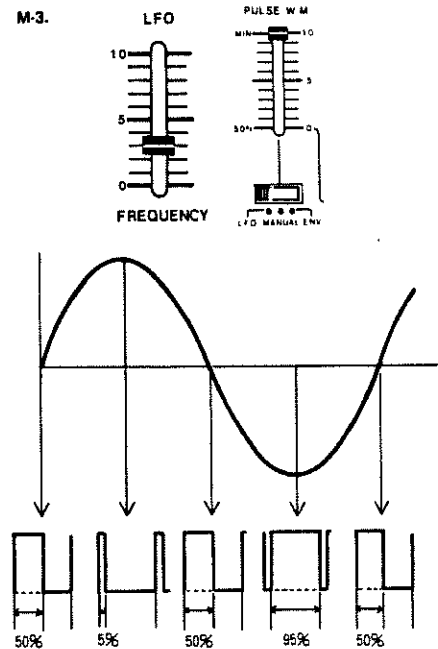

## ENVELOPE GENERATOR

This envelope generator functions in the same manner as in the Polyensemble and Bass Sections. The envelope curve generated here is also used for adjusting pulse width modulation, VCF, and VCA modulation.

# SOLO MELODY SECTION

## THE VCF (Voltage Controlled Filter)

In synthesizing sound, we begin with a waveform rich in harmonic content. We pass this signal through a VCF to filter out (eliminate) unwanted harmonics. This process is similar to that used by the artist who creates an elephant sculpture from a block of wood by carving away everything that doesn't look like an elephant.

With the controls set as shown below, the sounds from the mixer pass through the VCF unchanged.

M-4.

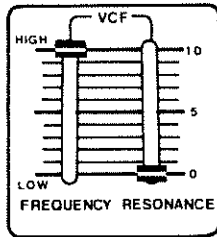

### (1) FREQUENCY Control

When you move this control down, it begins to shave off the upper harmonics one by one until you reach its lowest setting where nearly all sound is filtered out.

### (2) RESONANCE Control

Raising this control will accent the frequencies at the cutoff point of the VCF (which is determined by the FREQUENCY Control). The higher the setting of the RESONANCE Control, the stronger the effect.

If you move the RESONANCE Control up to approximately "8" or beyond, the frequencies at the cutoff point of the VCF will be accented so much that the VCF will start oscillating (generating sound) by itself.

Since the RESONANCE Control accents the frequencies at the VCF cutoff point, the output frequency of the VCF, when it is oscillating, (RESONANCE Control at "10") will be controlled by the FREQUENCY Control.

The fact that the cutoff point does not change unless you change it manually means that the harmonic content of the sound from the MIXER will change when you play different pitches. This is because the frequency of the pitches is changing while the VCF cutoff point is not.

## VCF MODULATION

Instead of manually adjusting the frequency control, VCF modulation automatically controls it through another control signal. Control is also possible by means of a pedal.

### (1) PITCH FOLLOWER

The PITCH F (pitch follow) function allows you to use the pitch control voltage from the Guitar Controller to move the VCF cutoff point along with the pitches as you play. In this way the harmonic content of the notes will remain the same.

- Set as illustrated below and produce sound with all modulation controls set at "0".

M-5.

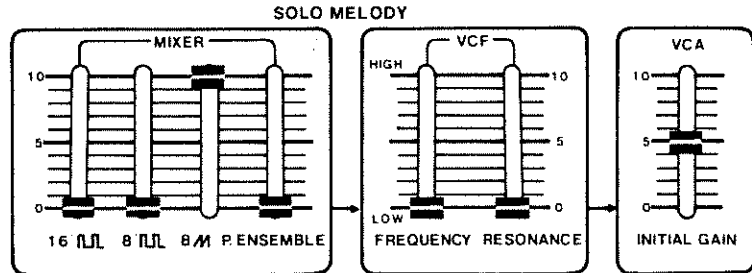

M-6.

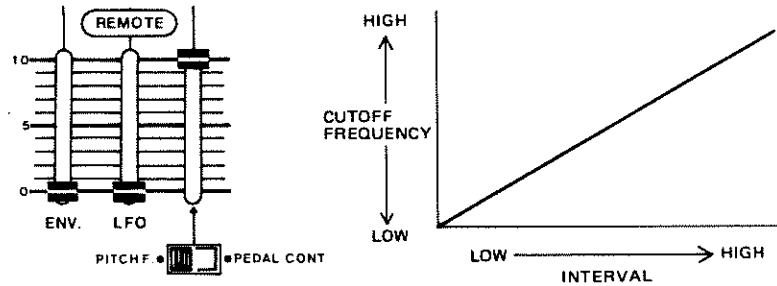

### (2) ENVELOPE GENERATOR

The harmonic content of notes produced by some instruments (especially wind instruments) will change during the production of each note. Using the ENV (envelope) control, this effect can be imitated.

Try this function as follows:

- Set the envelope generator as illustrated and prepare an envelope curve. Raise the ENVELOPE Slide Lever of the modulation section. Adjust the envelope generator to produce various envelope curves, and you will discover variations of sound.

M-7.

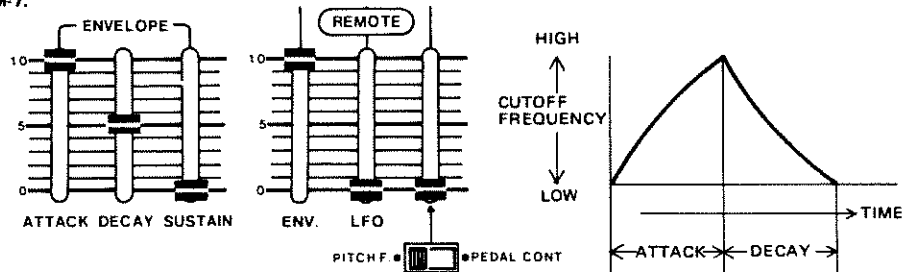

# SOLO MELODY SECTION

## (3) MODULATION BY LFO

This Slide Lever functions to adjust the cutoff frequency by means of a low frequency signal from the LFO. It is especially useful in creating a growl effect. The LFO frequency controls the growl speed.

The LFO modulation can be turned on and off by the Remote ON/OFF Switch located on the guitar.

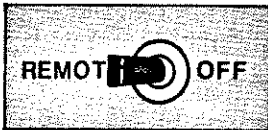
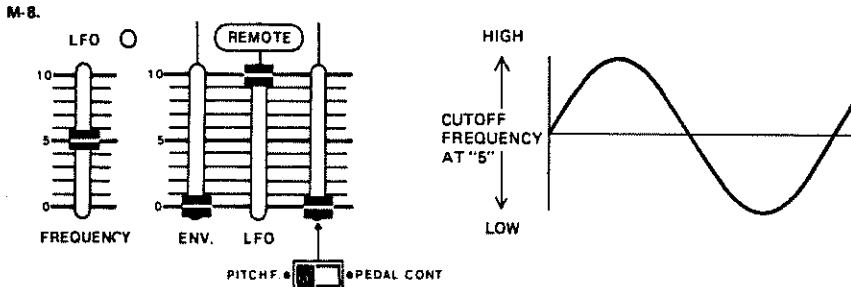

## USING REMOTE

The LFO modulation of the VCF can be turned on and off by the Remote ON/OFF Selector Switch located on the guitar.

This switch may also be used to activate other effects such as the chorus, vibrato, or reverb on external synthesizers, amplifiers or effect devices. To accomplish this, simply patch between the Remote Jack on the rear panel of the GR-500, and the desired remote jack (or the footswitch jack) of the external equipment or device.

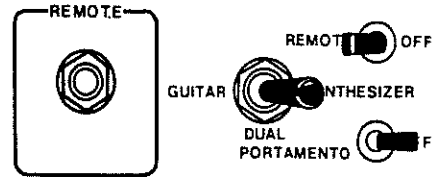

## (4) CONTROL BY PEDAL

The VCF can be controlled by pedal to achieve the same effects as when it is controlled manually.

### SETTING

Connect the Roland Foot Volume FV-2 to the VCF PEDAL CONT Jack on the rear panel.

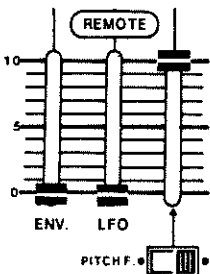
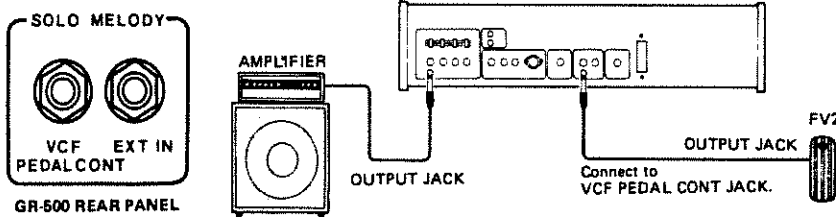

Set the switch to PEDAL CONT and set the slide lever to the desired position.

The maximum cutoff frequency level controlled by pedal will be determined by the slide lever.

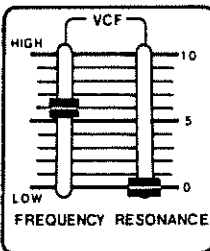

The VCF Cutoff Frequency Control and FV-2 Minimum Level may be set to any position.

The minimum cutoff frequency level controlled by pedal may be determined by these controls.

# SOLO MELODY SECTION

## VCA (VOLTAGE CONTROLLED AMPLIFIER)

The VCA controls the rise and fade of the sound. A VCA is an amplifier having an amplitude controlled by voltage.

## ENVELOPE GENERATOR AND INITIAL GAIN

Initial gain adjusts the volume independently of the envelope generator.

When driving the VCF cutoff frequency by means of the envelope generator, you are able to compensate for loss of volume (see page 13).

The slider marked ENVELOPE, below the VCA, determines the amount of control the envelope generator will have over the output sound (same as a volume control).

To try this function, follow this procedure:

### • Output level with Initial Gain only raised.

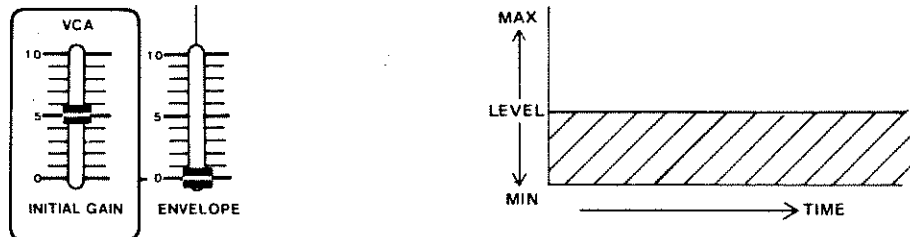

### • When envelope control only is raised.

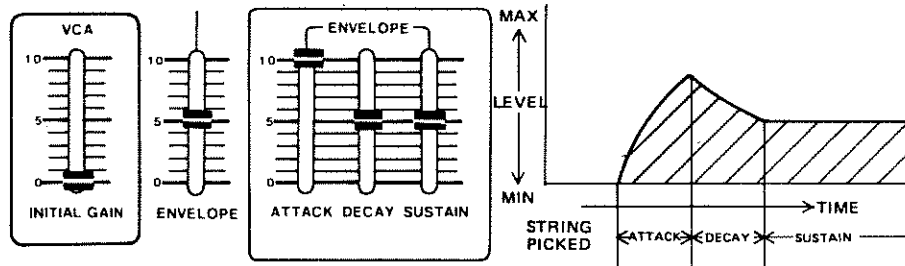

### • Output level when both initial gain and envelope controls are raised.

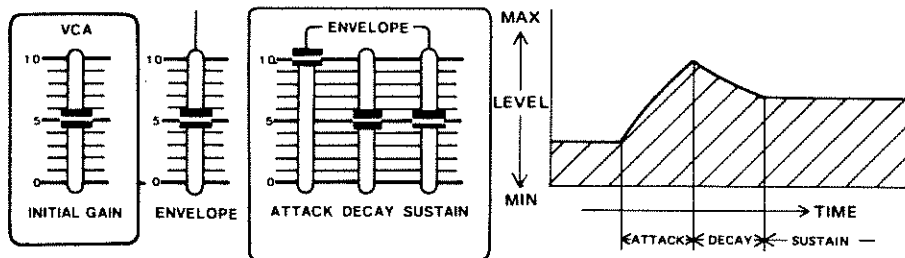

## TOUCH SENS SELECTOR SWITCH

This switch has the same effect as the TOUCH SENS Selector Switch of the Bass Section.



# EXTERNAL SYNTHESIZER SECTION

This section allows you to use the Guitar Controller to control an external synthesizer through the GR-500 Synthesizer.

The Transpose and Portamento features provide limitless possibilities in the creation of new sounds, or the reproduction of familiar ones. A TOUCH SENS Selector Switch is included in this section, as in the Bass and Solo Melody Sections.

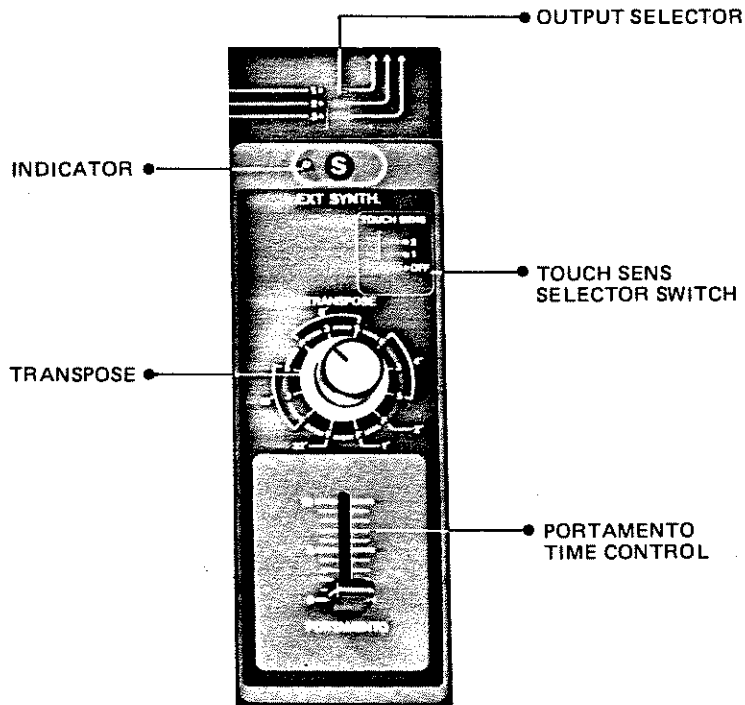

## PORTAMENTO TIME CONTROL

The guitar, through its inherent method of tone production, permits a certain amount of portamento, or pitch bending, to be achieved in normal playing. The Roland Guitar Synthesizer is designed to allow unlimited portamento, from its lowest to its highest note. Further, the time desired for this gradual change in pitch to reach completion is adjustable through the Portamento Time Control Slide Lever. As this lever is raised, the portamento time is increased.

Through the effective use of the GR-500's portamento feature, you can create choking, bottleneck and slide trombone effects using standard playing techniques.

When an external synthesizer is connected to the GR-500, portamento functions can be turned on or off by a portamento switch located at the guitar.

## GLISSANDO

The External Synthesizer Section allows you to perform glissando techniques in which one pitch of the external synthesizer slides to another independently of the portamento function. Also called "slide technique," the glissando is accomplished simply by sliding the finger on a string the same way as when bending the pitch in a conventional guitar.

## TRANSPOSE

This control governs the pitch of the entire External Synthesizer Section.

With the fifth string tuned at "A" 110Hz (standard tuning of a conventional guitar), "C" on the first fret of the second string is transposed as shown below, depending on the position of the Transpose Control:

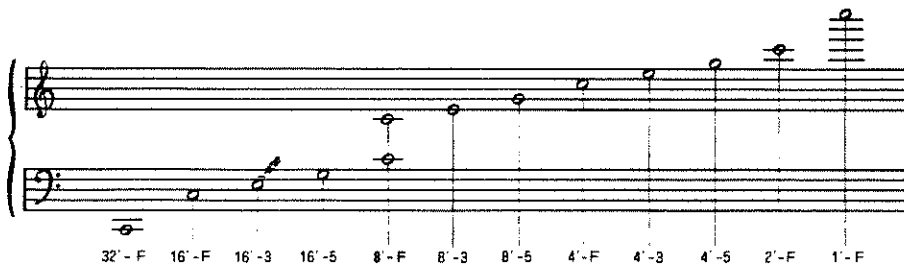

## TUNING

(1) For tuning the external synthesizer, set the Transpose Control to "8'-F."

(2) Using sound from the Guitar Section combined with the External Synthesizer Section, adjust the VCO pitch of the external synthesizer.

# EXTERNAL SYNTHESIZER SECTION

## OPERATING AN EXTERNAL SYNTHESIZER

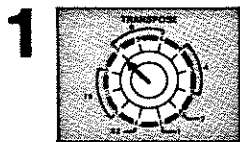

**GR-500**

After connecting the external synthesizer, set the Transpose Control to "B'-F" and PORTAMENTO TIME Control to "0".

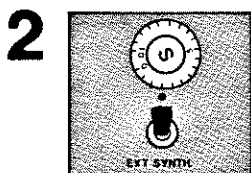

**Guitar Controller**

Set the External Synthesizer Section ON/OFF Switch to ON and raise the Volume and Master Volume control levels to their desired positions. FOR THE TIME BEING, KEEP ON/OFF SWITCHES OF OTHER SECTIONS OFF.



**GR-500**

Be sure the LED function indicator of the External Synthesizer Section illuminates.

Adjust the controls of the external synthesizer to achieve the desired sounds and/or effects.



**GR-500 Guitar Controller**

Set the Guitar Controller Portamento ON/OFF Selector Switch to ON and set the GR-500 Portamento Time Control Slide Lever to the desired position.

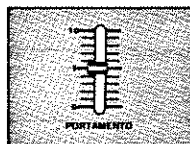

## CONNECTION WITH AN EXTERNAL SYNTHESIZER

The GR-500 can be connected to most synthesizers which have external input jacks. Examples of Roland synthesizers having this feature are the System 700 Main Console, System 700

Laboratory Synthesizer, System 100 Models 101 and 102, and Model SH-5.

### EXAMPLES

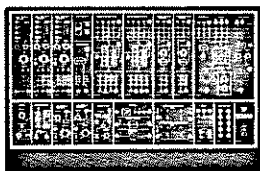

SYSTEM 700  
MAIN CONSOLE

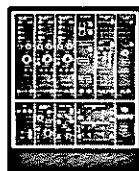

SYSTEM 700  
LABORATORY

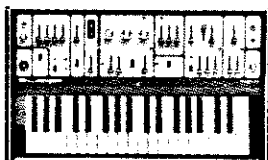

SYSTEM 100  
BASIC UNIT 101



SYSTEM 100  
EXPANDER 102

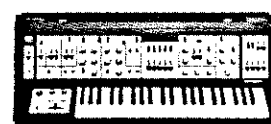

SH-5

### CONNECTION 1. SYSTEM 700

The GR-500 is provided with a six-conductor DIN jack for the exclusive connection of the System 700. By using this jack, both CV and GATE voltages can be conducted through a single cable.

### CONNECTION 2. SYSTEM 100 & SH-5

For connection of the SH-5, use the computer connection jacks on the rear panel, as in the case of the SYSTEM 100, Model 101, shown below:

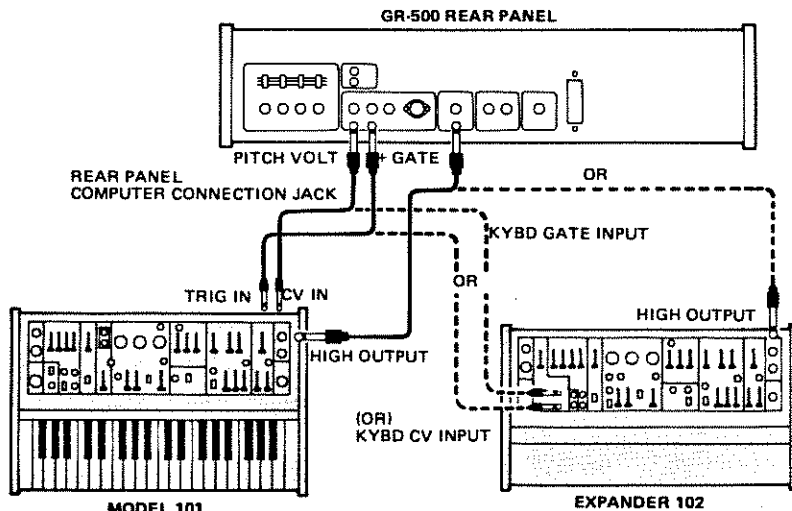
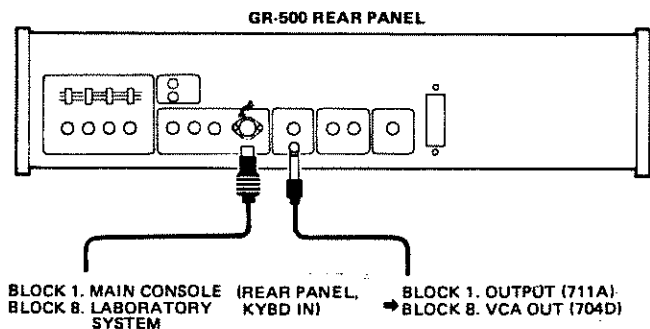

# EXTERNAL SYNTHESIZER SECTION

## CONNECTION 3. EXAMPLE OF CONNECTION FOR STRING ENSEMBLE (PATCH 14) AND BRASS ENSEMBLE (PATCH 15).

• When using System 700 Laboratory System.

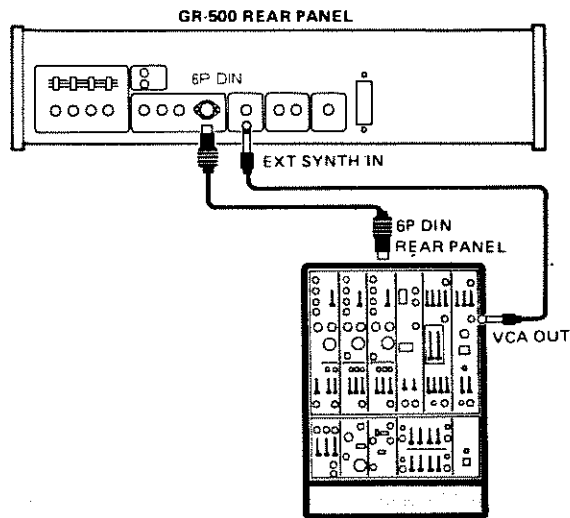

• When using System 100, Expander 102 and System 700 Laboratory System at the same time. — 1.

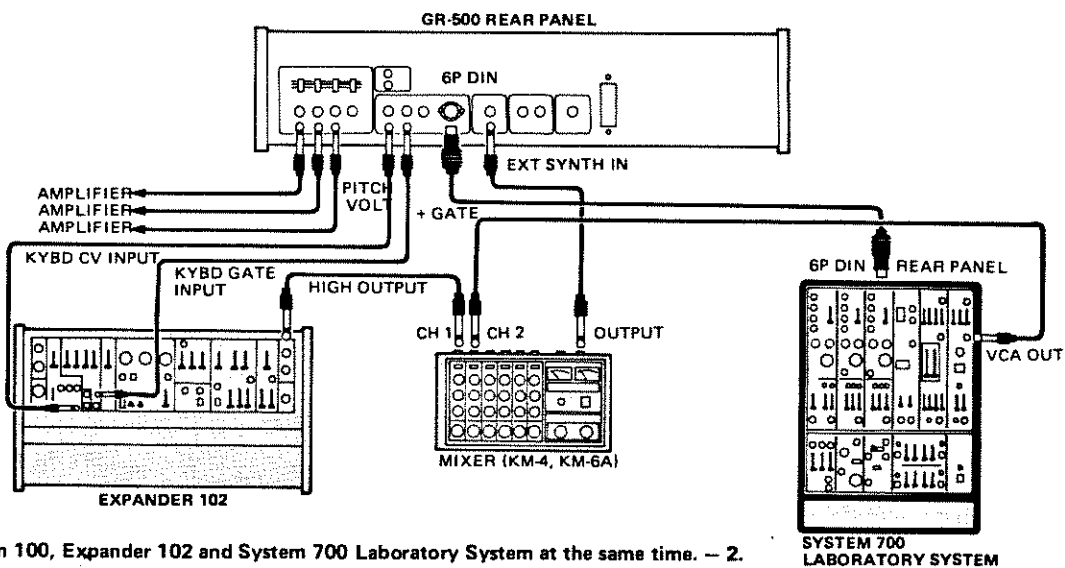

• When using System 100, Expander 102 and System 700 Laboratory System at the same time. — 2.

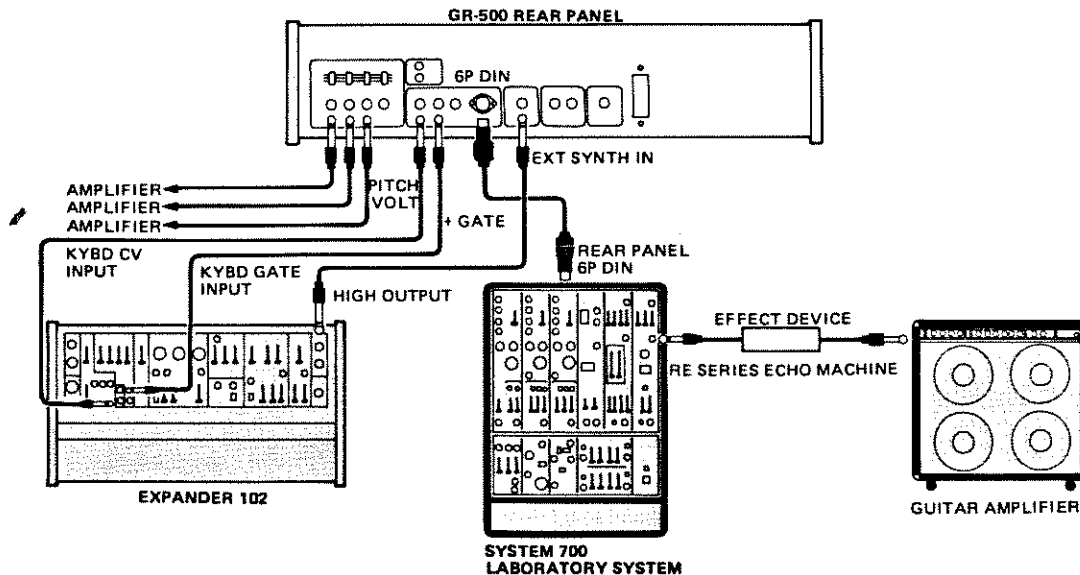

## GR-500 GUITAR SYNTHESIZER SPECIFICATIONS

### FRONT PANEL

#### COMMON

THRESHOLD CONTROL  
 THRESHOLD INDICATOR  
 HEADPHONES JACK  
 HEADPHONES LEVEL CONTROL  
 POWER SWITCH  
 POWER INDICATOR

#### GUITAR SECTION

OUTPUT CHANNEL SELECTOR SWITCH: 3/2/1  
 EQUALIZER ON/OFF CHANGEOVER SWITCH  
 EQUALIZER FREQUENCY CONTROL  
 INDICATOR LED

#### POLYENSEMBLE SECTION

OUTPUT CHANNEL SELECTOR SWITCH: 3/2/1  
 VOICING MIXER; FUNDAMENTAL, LOW, MIDDLE, HIGH  
 ENVELOPE GENERATOR; ATTACK, DECAY, SUSTAIN  
 INDICATOR LED

#### BASS SECTION

OUTPUT CHANNEL SELECTOR SWITCH: 3/2/1  
 VOICING MIXER; PERCUSSION, SOFT, HARD  
 PERCUSSION DECAY CHANGEOVER SWITCH: LONG/SHORT  
 ENVELOPE GENERATOR; ATTACK, DECAY, SUSTAIN  
 STRING SELECTOR SWITCH: 1-6 / 4,5,6 / 5,6  
 TOUCH SENSITIVITY CHANGEOVER SWITCH: 2/1/OFF  
 INDICATOR LED

#### SOLO MELODY SECTION

PULSE WIDTH MODULATION CONTROL  
 PULSE WIDTH MODULATION CHANGEOVER SWITCH: LFO/  
 MANUAL/ENVELOPE  
 VOICING MIXER; 16'  $\square$   $\square$  / 8'  $\square$   $\square$  / 8'  $\square$   $\square$  / POLYENSEMBLE  
 LFO FREQUENCY CONTROL

ENVELOPE GENERATOR: ATTACK, DECAY, SUSTAIN  
 VCF: CUTOFF FREQUENCY CONTROL, RESONANCE CONTROL  
 VCF MODULATION: ENVELOPE, LFO, PITCH FOLLOWER/PEDAL  
 CONTROL  
 PITCH FOLLOWER/PEDAL CONTROL CHANGEOVER SWITCH  
 VCA MODULATION: INITIAL GAIN, ENVELOPE  
 TOUCH SENSITIVITY CHANGEOVER SWITCH: 2/1/OFF  
 OUTPUT CHANNEL SELECTOR SWITCH: 3/2/1  
 INDICATOR LED

#### EXTERNAL SYNTHESIZER SECTION

OUTPUT CHANNEL SELECTOR SWITCH: 3/2/1  
 TRANSPOSE CHANGEOVER SWITCH: 32'-F / 16'-F, 16'-3, 16'-5 /  
 8'-F, 8'-3, 8'-5 / 4'-F, 4'-3, 4'-5 / 2'-F / 1'-F  
 PORTAMENTO TIME CONTROL  
 TOUCH SENSITIVITY CHANGEOVER SWITCH: 2/1/OFF  
 INDICATOR LED

### REAR PANEL

OUTPUT JACKS: CH-1, CH-2, CH-3, MIX  
 OUTPUT LEVEL CHANGEOVER SWITCHES: H/M/L  
 EXTERNAL SYNTHESIZER CONTROL JACKS: PITCH VOLTAGE  
 OUT, +GATE OUT, -GATE OUT, 6P DIN JACK (FOR SYSTEM 700)  
 EXTERNAL SYNTHESIZER INPUT JACK  
 SOLO MELODY SECTION: VCF PEDAL CONTROLLER OUT JACK,  
 EXTERNAL INPUT JACK  
 REMOTE OUT JACK  
 FROM GUITAR CONNECTOR

POWER CONSUMPTION: 19W  
 DIMENSIONS: 603(W) x 154(H) x 309(D)MM  
 WEIGHT: 9.2KG  
 ACCESSORY: CONNECTION CORD (C-24B)

\* Specifications are subject to change without notice.



**Roland®**

---

**10154**

UPC

10154



1099:

**Roland®**

## Free Manuals Download Website

<http://myh66.com>

<http://usermanuals.us>

<http://www.somanuals.com>

<http://www.4manuals.cc>

<http://www.manual-lib.com>

<http://www.404manual.com>

<http://www.luxmanual.com>

<http://aubethermostatmanual.com>

Golf course search by state

<http://golfingnear.com>

Email search by domain

<http://emailbydomain.com>

Auto manuals search

<http://auto.somanuals.com>

TV manuals search

<http://tv.somanuals.com>