

HP-7/3 Roland Digital Piano

Owner's Manual

Thank you, and congratulations on your choice of the Roland Digital Piano HP-7/3.

Main Features

Piano sounds with rich resonance and wide-ranging expressiveness

The stereo sampling piano sound generator realistically reproduces even the sound of the hammers striking the strings, producing the tones of a high-quality concert grand piano. Maximum polyphony of 64 notes ensures that you can use the pedal freely without running out of notes.

The HP-7 features a new speaker system to provide sounds with depth and spatial realism.

Pursuing the playing feel of a grand piano

These instruments feature a progressive hammer action keyboard, which duplicates the touch of a grand piano, with a heavier touch in the lower register, and a lighter touch in the upper register. In addition, on the HP-7, even the distinctive "click" that you feel when pressing a key on a grand piano has been faithfully simulated (escapement mechanism).

The pedal is designed for good-feeling response, and allows subtle performance nuances to be expressed.

A variety of practice features to help you develop your musicality

In addition to a metronome, the HP-7/3 features a rhythm function, which encourages your natural sense of rhythm, and a two-track recorder, which allows you to experience piano lessons in a way possible only on electronic pianos.

An enjoyable ear-training game is also built-in.

65 piano songs built-in

The built-in songs are mainly classical pieces, and include compositions for listening enjoyment as well as for lessons. The included music score collection (60 songs) is also supported.

Piano Customize function lets you adjust details of the sound (HP-7)

This simulates the tonal changes that occur when the lid of a grand piano is opened or closed, allowing you to play using the piano sound you want.

Adjustable music stand (HP-7)

In addition to allowing you to adjust the angle of the stand, and move it forward or backward, the music holders accommodates even thick score books.

Before using this unit, carefully read the sections entitled: "USING THE UNIT SAFELY" and "IMPORTANT NOTES" (p. 4; p. 6). These sections provide important information concerning the proper operation of the unit. Additionally, in order to feel assured that you have gained a good grasp of every feature provided by your new unit, Owner's manual should be read in its entirety. The manual should be saved and kept on hand as a convenient reference.

Copyright © 2002 ROLAND CORPORATION

All rights reserved. No part of this publication may be reproduced in any form without the written permission of ROLAND CORPORATION.

	CAUTION RISK OF ELECTRIC SHOCK DO NOT OPEN	
ATTENTION: RISQUE DE CHOC ELECTRIQUE NE PAS OUVRIR		
<p>CAUTION: TO REDUCE THE RISK OF ELECTRIC SHOCK, DO NOT REMOVE COVER (OR BACK). NO USER-SERVICEABLE PARTS INSIDE. REFER SERVICING TO QUALIFIED SERVICE PERSONNEL.</p>		



The lightning flash with arrowhead symbol, within an equilateral triangle, is intended to alert the user to the presence of uninsulated "dangerous voltage" within the product's enclosure that may be of sufficient magnitude to constitute a risk of electric shock to persons.



The exclamation point within an equilateral triangle is intended to alert the user to the presence of important operating and maintenance (servicing) instructions in the literature accompanying the product.

INSTRUCTIONS PERTAINING TO A RISK OF FIRE, ELECTRIC SHOCK, OR INJURY TO PERSONS.

IMPORTANT SAFETY INSTRUCTIONS SAVE THESE INSTRUCTIONS

WARNING - When using electric products, basic precautions should always be followed, including the following:

1. Read these instructions.
2. Keep these instructions.
3. Heed all warnings.
4. Follow all instructions.
5. Do not use this apparatus near water.
6. Clean only with a dry cloth.
7. Do not block any of the ventilation openings. Install in accordance with the manufacturers instructions.
8. Do not install near any heat sources such as radiators, heat registers, stoves, or other apparatus (including amplifiers) that produce heat.
9. Do not defeat the safety purpose of the polarized or grounding-type plug. A polarized plug has two blades with one wider than the other. A grounding type plug has two blades and a third grounding prong. The wide blade or the third prong are provided for your safety. When the provided plug does not fit into your outlet, consult an electrician for replacement of the obsolete outlet.
10. Protect the power cord from being walked on or pinched particularly at plugs, convenience receptacles, and the point where they exit from the apparatus.
11. Only use attachments/accessories specified by the manufacturer.
12. Never use with a cart, stand, tripod, bracket, or table except as specified by the manufacturer, or sold with the apparatus. When a cart is used, use caution when moving the cart/apparatus combination to avoid injury from tip-over.
13. Unplug this apparatus during lightning storms or when unused for long periods of time.
14. Refer all servicing to qualified service personnel. Servicing is required when the apparatus has been damaged in any way, such as power-supply cord or plug is damaged, liquid has been spilled or objects have fallen into the apparatus, the apparatus has been exposed to rain or moisture, does not operate normally, or has been dropped.



For the U.K.

IMPORTANT: THE WIRES IN THIS MAINS LEAD ARE COLOURED IN ACCORDANCE WITH THE FOLLOWING CODE.

BLUE: NEUTRAL
BROWN: LIVE

As the colours of the wires in the mains lead of this apparatus may not correspond with the coloured markings identifying the terminals in your plug, proceed as follows:

The wire which is coloured BLUE must be connected to the terminal which is marked with the letter N or coloured BLACK.

The wire which is coloured BROWN must be connected to the terminal which is marked with the letter L or coloured RED.

Under no circumstances must either of the above wires be connected to the earth terminal of a three pin plug.

USING THE UNIT SAFELY

INSTRUCTIONS FOR THE PREVENTION OF FIRE, ELECTRIC SHOCK, OR INJURY TO PERSONS

About ⚠ WARNING and ⚠ CAUTION Notices

⚠ WARNING	Used for instructions intended to alert the user to the risk of death or severe injury should the unit be used improperly.
⚠ CAUTION	Used for instructions intended to alert the user to the risk of injury or material damage should the unit be used improperly. * Material damage refers to damage or other adverse effects caused with respect to the home and all its furnishings, as well to domestic animals or pets.

About the Symbols

	The ⚠ symbol alerts the user to important instructions or warnings. The specific meaning of the symbol is determined by the design contained within the triangle. In the case of the symbol at left, it is used for general cautions, warnings, or alerts to danger.
	The ⚡ symbol alerts the user to items that must never be carried out (are forbidden). The specific thing that must not be done is indicated by the design contained within the circle. In the case of the symbol at left, it means that the unit must never be disassembled.
	The ⚡ symbol alerts the user to things that must be carried out. The specific thing that must be done is indicated by the design contained within the circle. In the case of the symbol at left, it means that the power-cord plug must be unplugged from the outlet.

ALWAYS OBSERVE THE FOLLOWING



⚠ WARNING

- Before using this unit, make sure to read the instructions below, and the Owner's Manual.
- Do not open or perform any internal modifications on the unit.
- Do not attempt to repair the unit, or replace parts within it (except when this manual provides specific instructions directing you to do so). Refer all servicing to your retailer, the nearest Roland Service Center, or an authorized Roland distributor, as listed on the "Information" page.
- Never use or store the unit in places that are:
 - Subject to temperature extremes (e.g., direct sunlight in an enclosed vehicle, near a heating duct, on top of heat-generating equipment); or are
 - Damp (e.g., baths, washrooms, on wet floors); or are
 - Humid; or are
 - Exposed to rain; or are
 - Dusty; or are
 - Subject to high levels of vibration.
- Make sure you always have the unit placed so it is level and sure to remain stable. Never place it on stands that could wobble, or on inclined surfaces.
- The unit should be connected to a power supply only of the type described in the operating instructions, or as marked on the unit.
- Use only the attached power-supply cord. Also, the supplied power cord must not be used with any other device.







⚠ WARNING

- Do not excessively twist or bend the power cord, nor place heavy objects on it. Doing so can damage the cord, producing severed elements and short circuits. Damaged cords are fire and shock hazards!
- This unit, either alone or in combination with an amplifier and headphones or speakers, may be capable of producing sound levels that could cause permanent hearing loss. Do not operate for a long period of time at a high volume level, or at a level that is uncomfortable. If you experience any hearing loss or ringing in the ears, you should immediately stop using the unit, and consult an audiologist.
- Do not allow any objects (e.g., flammable material, coins, pins); or liquids of any kind (water, soft drinks, etc.) to penetrate the unit.
- In households with small children, an adult should provide supervision until the child is capable of following all the rules essential for the safe operation of the unit.
- Protect the unit from strong impact. (Do not drop it!)
- Do not force the unit's power-supply cord to share an outlet with an unreasonable number of other devices. Be especially careful when using extension cords—the total power used by all devices you have connected to the extension cord's outlet must never exceed the power rating (watts/amperes) for the extension cord. Excessive loads can cause the insulation on the cord to heat up and eventually melt through.





⚠ WARNING

- Before using the unit in a foreign country, consult with your retailer, the nearest Roland Service Center, or an authorized Roland distributor, as listed on the "Information" page. 
- Do not put anything that contains water (e.g., flower vases) on this unit. Also, avoid the use of insecticides, perfumes, alcohol, nail polish, spray cans, etc., near the unit. Swiftly wipe away any liquid that spills on the unit using a dry, soft cloth. 

⚠ CAUTION

- The unit should be located so that its location or position does not interfere with its proper ventilation. 
- Always grasp only the plug on the power-supply cord when plugging into, or unplugging from, an outlet or this unit. 
- At regular intervals, you should unplug the power plug and clean it by using a dry cloth to wipe all dust and other accumulations away from its prongs. Also, disconnect the power plug from the power outlet whenever the unit is to remain unused for an extended period of time. Any accumulation of dust between the power plug and the power outlet can result in poor insulation and lead to fire. 
- Try to prevent cords and cables from becoming entangled. Also, all cords and cables should be placed so they are out of the reach of children. 
- Never climb on top of, nor place heavy objects on the unit. 
- Never handle the power cord or its plugs with wet hands when plugging into, or unplugging from, an outlet or this unit. 

⚠ CAUTION

- If you need to move the instrument, take note of the precautions listed below. At least two persons are required to safely lift and move the unit. It should be handled carefully, all the while keeping it level. Make sure to have a firm grip, to protect yourself from injury and the instrument from damage. 
 - Check to make sure the knob bolts securing the unit to the stand have not become loose. Fasten them again securely whenever you notice any loosening.
 - Disconnect the power cord.
 - Disconnect all cords coming from external devices.
 - Raise the adjusters on the stand (p. 12).
 - Close the lid.
 - Remove the music stand. (HP-3)
 - Fold down the music stand. (HP-7)
- Before cleaning the unit, turn off the power and unplug the power cord from the outlet (p. 10). 
- Whenever you suspect the possibility of lightning in your area, pull the plug on the power cord out of the outlet. 
- Be careful when opening/closing the lid so you do not get your fingers pinched (p. 11). Adult supervision is recommended whenever small children use the unit. 
- Should you remove the screws fastening the stand, make sure to put them in a safe place out of children's reach, so there is no chance of them being swallowed accidentally. 

IMPORTANT NOTES

In addition to the items listed under “IMPORTANT SAFETY INSTRUCTIONS” and “USING THE UNIT SAFELY” on pages 3, 4 and 5, please read and observe the following:

Power Supply

- Do not use this unit on the same power circuit with any device that will generate line noise (such as an electric motor or variable lighting system).
- Before connecting this unit to other devices, turn off the power to all units. This will help prevent malfunctions and/or damage to speakers or other devices.
- Although the LCD and LEDs are switched off when the POWER switch is switched off, this does not mean that the unit has been completely disconnected from the source of power. If you need to turn off the power completely, first turn off the POWER switch, then unplug the power cord from the power outlet. For this reason, the outlet into which you choose to connect the power cord's plug should be one that is within easy reach.

Placement

- Using the unit near power amplifiers (or other equipment containing large power transformers) may induce hum. To alleviate the problem, change the orientation of this unit; or move it farther away from the source of interference.
- This device may interfere with radio and television reception. Do not use this device in the vicinity of such receivers.
- Noise may be produced if wireless communications devices, such as cell phones, are operated in the vicinity of this unit. Such noise could occur when receiving or initiating a call, or while conversing. Should you experience such problems, you should relocate such wireless devices so they are at a greater distance from this unit, or switch them off.
- Do not expose the unit to direct sunlight, place it near devices that radiate heat, leave it inside an enclosed vehicle, or otherwise subject it to temperature extremes. Also, do not allow lighting devices that normally are used while their light source is very close to the unit (such as a piano light), or powerful spotlights to shine upon the same area of the unit for extended periods of time. Excessive heat can deform or discolor the unit.
- To avoid possible breakdown, do not use the unit in a wet area, such as an area exposed to rain or other moisture.
- Do not allow rubber, vinyl, or similar materials to remain on the piano for long periods of time. Such objects can discolor or otherwise harmfully affect the finish.
- Do not allow objects to remain on top of the keyboard. This can be the cause of malfunction, such as keys ceasing to produce sound.
- Do not paste stickers, decals, or the like to this instrument. Peeling such matter off the instrument may damage the exterior finish.

Maintenance

- To clean the unit, use a dry, soft cloth; or one that is slightly dampened. Try to wipe the entire surface using an equal amount of strength, moving the cloth along with the grain of the wood. Rubbing too hard in the same area can damage the finish.
- Never use benzine, thinners, alcohol or solvents of any kind, to avoid the possibility of discoloration and/or deformation.
- The pedals of this unit are made of brass. Brass eventually darkens as the result of the natural oxidization process. If the brass becomes tarnished, polish it using commercially available metal polisher.

Additional Precautions

- Use a reasonable amount of care when using the unit's buttons, sliders, or other controls; and when using its jacks and connectors. Rough handling can lead to malfunctions.
- When connecting / disconnecting all cables, grasp the connector itself—never pull on the cable. This way you will avoid causing shorts, or damage to the cable's internal elements.
- A small amount of heat will radiate from the unit during normal operation.
- To avoid disturbing your neighbors, try to keep the unit's volume at reasonable levels. You may prefer to use headphones, so you do not need to be concerned about the volume.
- When you need to transport the unit, pack it in shock-absorbent material. Transporting the unit without doing so can cause it to become scratched or damaged, and could lead to malfunction.
- Do not apply undue force to the music stand while it is in use.(HP-7)
- Use a cable from Roland to make the connection. If using some other make of connection cable, please note the following precautions.
 - Some connection cables contain resistors. Do not use cables that incorporate resistors for connecting to this unit. The use of such cables can cause the sound level to be extremely low, or impossible to hear. For information on cable specifications, contact the manufacturer of the cable.
- Before opening or closing the keyboard lid, always make sure that no pets or other small animals are located on top of the instrument (in particular, they should be kept away from the keyboard and its lid). Otherwise, due to the structural design of this instrument, small pets or other animals could end up getting trapped inside it. If such a situation is encountered, you must immediately switch off the power and disconnect the power cord from the outlet. You should then consult with the retailer from whom the instrument was purchased, or contact the nearest Roland Service Center.

Contents

USING THE UNIT SAFELY	4
IMPORTANT NOTES	6
Contents.....	7
Panel Descriptions.....	8
Front Panel	8
Rear Panel.....	9
Before You Start Playing	10
Connect the Pedal Cable	10
Connect the Speaker Cable (HP-7)	10
Connect the Power Cord.....	10
Setting Up the Music Stand (HP-3)	10
Setting Up the Music Stand (HP-7)	10
Adjusting the position of the music stand.....	11
Folding down the music stand.....	11
Using the music holders.....	11
Removing the music stand	11
Opening/Closing the Lid	11
Connecting Headphones.....	11
Turning the Power On and Off.....	12
Adjusting the Sound's Volume and Brilliance.....	12
About the Pedals	12
Chapter 1.	
Enjoying the Built-in Songs and Game.....	13
Listening to Built-in Songs.....	13
Playing back all songs continuously (All Song Play)	13
Selecting a song and playing it	13
Playing the Note-guessing Game	14
Chapter 2. Performance.....	15
Performing with a Variety of Sounds	15
Playing Two Sounds Together (Dual Performance)	16
Adjusting the volume balance in Dual performance (Dual Balance).....	16
Playing Different Tones with the Left and Right Hands (Split Performance)	17
Changing the keyboard's split point.....	18
Using Metronome and Rhythm	18
Sounding the metronome	18
Changing the metronome and rhythm volume.....	19
Playing rhythm.....	20
Applying Effects to the Sound	21
Adding reverberation to the sound (Reverb).....	21
Adding richness to the sound (Chorus).....	21
Changing the amount of effect applied	21
Transposing the Key of the Keyboard (Transpose).....	22
Adjusting the Keyboard Touch (Key Touch)	23
Making Fine Adjustments to the Piano Sound (Piano Customize) (HP-7).....	24
Chapter 3.	
Playing Along with the Built-in Songs	25
Changing the Tempo	25
Adding a count-in to match the timing (Count In).....	25
Playing Each Hand Separately.....	26
Chapter 4. Recording Your Performance.....	27
Notes regarding recording.....	27
Recording a New Song.....	28
Recording Along with the Rhythm	29
Recording Along with a Song	30
Selecting and Recording the Track for Each Hand Separately..	31
Erasing Recorded Performances	32
Erasing a performance from the specified track.....	32
Erasing a song.....	32
Chapter 5. Changing Various Settings.....	33
Changing the Damper Pedal's Resonance.....	33
Making Detailed Settings (Function).....	33
Tuning to other instruments' pitches (Master Tuning)	34
Changing the temperament.....	34
Setting the tuning curve (Stretch Tuning)	35
Applying the damper pedal to the left-hand keyboard area	35
Disabling Everything Except Piano Play (Panel Lock).....	35
Chapter 6. Connecting External Devices	36
Connecting to Audio Equipment.....	36
Connecting to a Computer.....	36
Connecting MIDI Devices	37
What's MIDI?	37
Making MIDI-related Settings.....	37
MIDI send channel settings	38
Switching Local Control on and off.....	38
Transmitting a performance you recorded	38
Appendices.....	39
Troubleshooting	39
Error Messages/Other Messages.....	40
Tone List	41
Built-in Song List.....	42
Rhythm List.....	44
Easy Operation List.....	45
MIDI Implementation Chart.....	46
Main Specifications	47
Index.....	48

Panel Descriptions

* The panel diagrams shown in this owner's manual are those of the HP-7.

Front Panel

HP-7

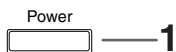
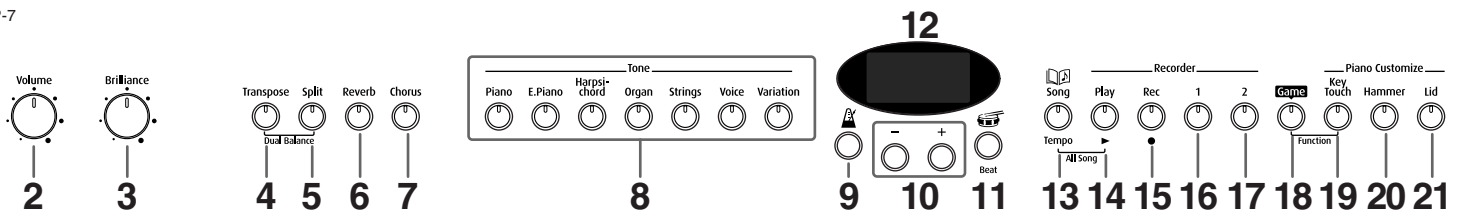

1 [Power] switch

Turns the power on/off (p. 12).

2 [Volume] knob

Adjusts the overall volume level (p. 12).

3 [Brilliance] knob

Adjusts the tone brightness (p. 12).

4 [Transpose] button

Transposes the pitch of the keyboard (p. 22).

5 [Split] button

Divides the keyboard into right-hand and left-hand areas, allowing you to play a different sound in each area (p. 17).

6 [Reverb] button

Adds reverberation to the sound (p. 21).

7 [Chorus] button

Adds richness to the sound (p. 21).

8 Tone buttons

They are used to choose the kinds of tones (tone groups) played by the keyboard (p. 15).

9 [Metronome] Button

Turns the metronome on/off (p. 18).

10 [+]/[-] buttons

Allow you to select the value of various settings. Pressing both the [+] and [-] buttons simultaneously returns the setting of a particular item or function to its original value.

11 [Rhythm/Beat] button

Switches the rhythm on/off (p. 20). In addition, pressing this button will display the rhythm number.

Hold down this button and press the [+] or [-] button to specify the time signature (beat) (p. 19, p. 20).

12 Display

Displays information such as the song number, rhythm number, tempo, beat, and parameter settings values.

13 [Song/Tempo] Button

Used to select from the built-in songs (p. 13, p. 25).

Each time you press this button, the song number and the tempo will be displayed alternately.

Recorder

Plays back or records a performance.

14 [Play] button

Starts and stops playback of built-in songs and recorded performances (p. 13, p. 25).

Also starts/stops recording of a performance (p. 28–p. 31).

15 [Rec] button

Puts the HP-7/3 in recording-standby mode (p. 27–p. 32).

16 [1] button

Plays back or records a performance separately for each hand. (p. 26, p. 30–p. 32).

The left-hand performances of the built-in songs are assigned to this button.

This button and the following [2] button are collectively referred to as the “track buttons.”

17 [2] button

Plays back or records a performance separately for each hand. (p. 26, p. 30–p. 32).

The right-hand performances of the built-in songs are assigned to this button.

18 [Game] Button

Lets you enjoy a note-guessing game (p. 14).

Piano Customize

19 [Key Touch] button

Modifies the playing feel of the keyboard (p. 23).

By holding down this button and the [Game] button, and pressing other specified button, you can make settings for various functions (p. 33–p. 35, p. 37–p. 38).

20 [Hammer] button (HP-7)

Adjusts how variations in your keyboard playing strength will modify the timing at which notes are sounded (p. 24).

21 [Lid] button (HP-7)

Simulates the tonal changes that occur when the lid of a grand piano is opened or closed (p. 24).

Rear Panel

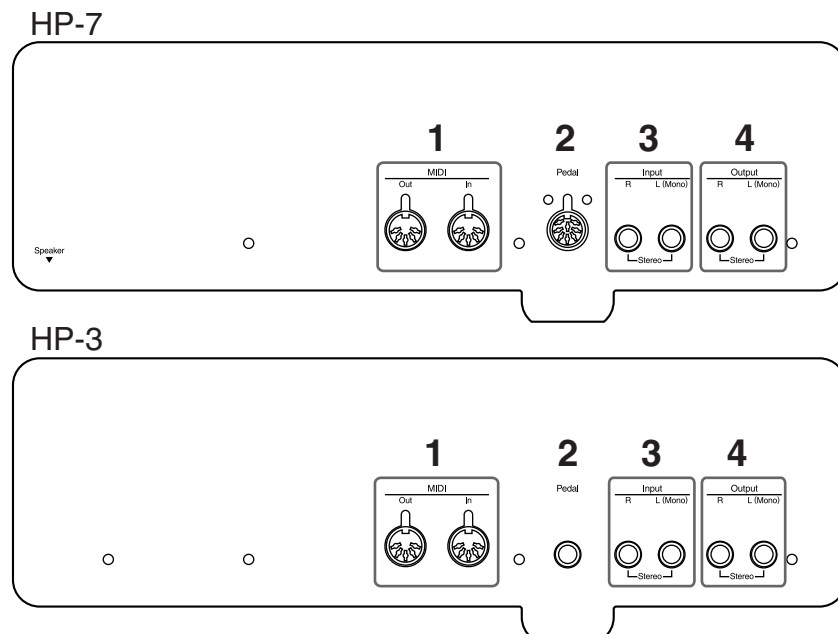

1 MIDI Out/In connectors

Connect to external MIDI devices to exchange performance data (p. 37).

2 Pedal connector

Connect the pedal cable of the special stand to this connector (p. 10).

3 Input jacks

These jacks can be connected to another sound generating device or an audio device, so that the sound of that device will be output from the HP-7/3's speakers (p. 36).

4 Output jacks

Allows you to output the piano's sound to sound reinforcement equipment to obtain a more powerful sound. These can also be connected to a tape recorder or other recording device to record a performance (p. 36).

Before You Start Playing

Connect the Pedal Cable

Insert the pedal cable into the Pedal connector on the rear panel of the HP-7/3.

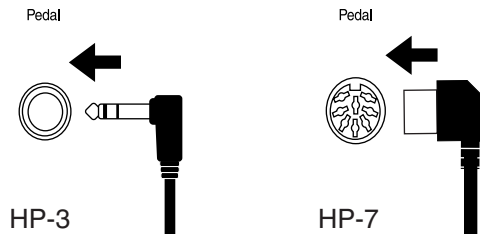

Connect the Speaker Cable (HP-7)

As shown in the diagram, connect the speaker cable leading from the speaker box of the stand to the speaker connector located on the rear panel of the HP-7.

Push the speaker cable in until it clicks into position.

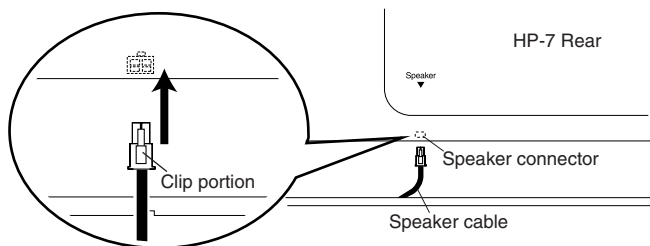

NOTE

Do not place containers holding liquids (such as flower vases), insecticide, perfume, alcohol, or similar substances on top of this piano.

The speakers of this piano are mounted beneath the upper surface, and face upwards. Malfunctions or accidents may occur if liquids contact any part of the speakers.

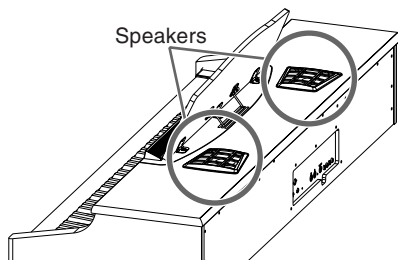

Connect the Power Cord

Insert the included power cable into the AC inlet on the bottom panel of the HP-7/3, and then plug it into an electrical outlet.

NOTE

Be sure to use the supplied power cord.

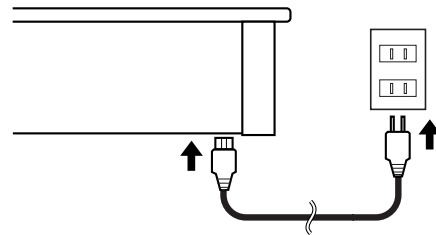

Setting Up the Music Stand (HP-3)

Insert the music stand into the two holes as shown in the following diagram.

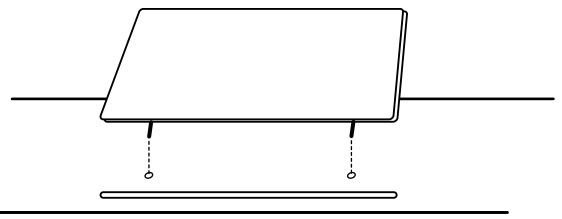

NOTE

Before moving the piano, be sure to remove the music stand to prevent accidents.

Setting Up the Music Stand (HP-7)

1. Grasping the music stand with both hands, lift it toward you until it is in the upright position.
2. Use the support on the back of the music stand to keep the stand in place.

The angle of the music stand can be set to any of three positions.

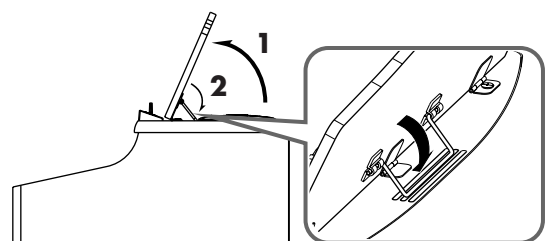

■ Adjusting the position of the music stand

Grasp the music stand with both hands, and pull it toward yourself to adjust the position.

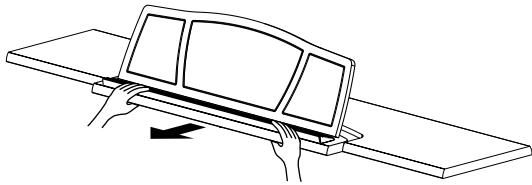

■ Folding down the music stand

1. Grasp the music stand with both hands, and gently push it in until it stops.
2. Raise the support located on the back of the music stand, then gently fold down the music stand.

■ Using the music holders

You can use the holders to hold pages in place. When not using the holders, leave them folded down.

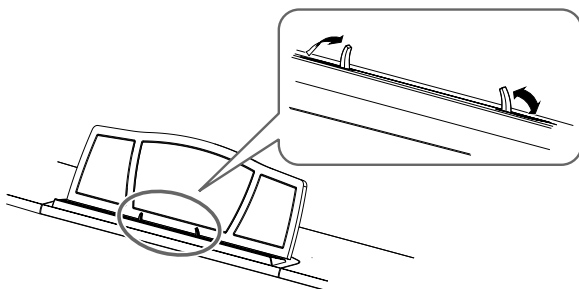

■ Removing the music stand

You can remove the music stand from the piano. This allows you to place a notebook computer on the piano.

Position the music stand so it's upright, then remove the three screws, as shown.

You can remove the screws using a coin.

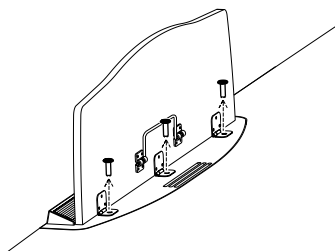

NOTE

Be careful not to lose the screws that you removed from the music stand, or put them where they might be swallowed by small children.

Opening/Closing the Lid

To open the lid, use both hands to lift it lightly, and slide it away from yourself.

To close the lid, pull it gently toward yourself, and lower it softly after it has been fully extended.

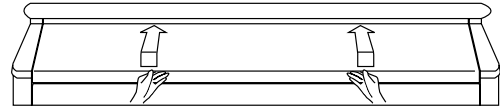

NOTE

When opening and closing the lid, be careful not to let your fingers get caught. If small children will be using the HP-7/3, adult supervision should be provided.

If you need to move the piano, make sure the lid is closed first to prevent accidents.

Connecting Headphones

The HP-7/3 has two jacks for plugging in headphones. This allows two people to listen through headphones simultaneously, making it very useful for lessons and when performing piano pieces for four hands. Additionally, this allows you to play without having to worry about bothering others around you, even at night.

Plug the headphones into the Phones jack located at the bottom left of the piano.

Connecting headphones will automatically mute the sound from the internal speakers.

The headphone volume is adjusted by the [Volume] knob (p. 12) of the HP-7/3.

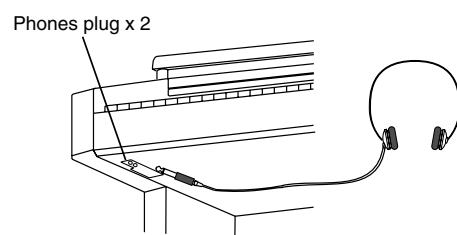

NOTE

Use Stereo headphones.

Make sure to use only Roland headphones. Headphones from other manufacturers may be unable to provide sufficient volume.

Some notes on using headphones

- To prevent damage to the cord, handle the headphones only by the headset or the plug.
- Connecting the headphones when the volume of connected equipment is turned up may result in damage to the headphones. Lower the volume on the HP-7/3 before plugging in the headphones.
- Listening at excessively high volume levels will not only damage the headphones, but may also cause hearing loss. Use the headphones at a moderate volume level.

Before You Start Playing

Turning the Power On and Off

NOTE

Turn on power to your various devices in the order specified. By turning on devices in the wrong order, you risk causing malfunction and/or damage to speakers and other devices.

To turn the power on, turn the [Volume] knob all the way down, and then press the [Power] switch.

The power will turn on, and the Power indicator at the left front of the HP-7/3 will light.

After a few seconds, you will be able to play the keyboard to produce sound.

Use the [Volume] knob to adjust the volume.

NOTE

This unit is equipped with a protection circuit. A brief interval (a few seconds) after power up is required before the unit will operate normally.

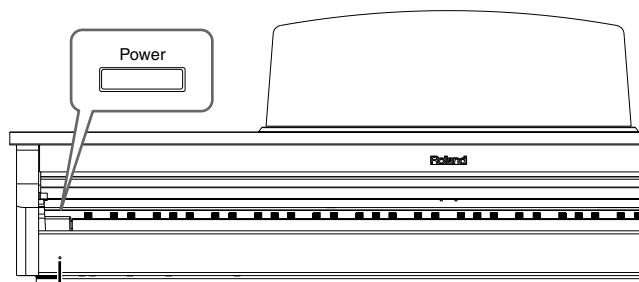

Power Indicator

To turn the power off, turn the [Volume] knob all the way to the left, and press the [Power] switch.

The Power indicator at the left front of the HP-7/3 will go dark, and the power will be turned off.

Adjusting the Sound's Volume and Brilliance

Turn the [Volume] knob to adjust the overall volume.

Turn the [Brilliance] knob to adjust the brightness of the sound.

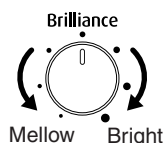
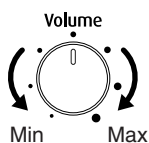

About the Pedals

The pedals have the following functions, and are used mainly for piano performance.

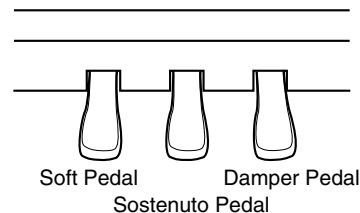

Damper pedal (right pedal)

While this pedal is pressed, notes will be sustained even after you take your fingers off the keys.

On the HP-7, the length of sustain will change subtly depending on how deeply you press the pedal.

On an acoustic piano, holding down the damper pedal will allow the remaining strings to resonate in sympathy with the sounds that you played from the keyboard, adding a rich resonance.

The HP-7/3 simulates this sympathetic resonance.

MEMO

You can change the amount of resonance applied with the damper pedal. Please refer to "Changing the Damper Pedal's Resonance" (p. 33).

Sostenuto pedal (center pedal)

This pedal sustains only the sounds of the keys that were already played when you pressed the pedal.

Soft pedal (left pedal)

When you hold down this pedal and play the keyboard, the sound will have a softer tone.

On the HP-7, the softness of the tone can be varied subtly by the depth to which you press the pedal.

About the adjuster

When you move the HP-7/3 or if you feel that the pedals are unstable, adjust the adjuster located below the pedals as follows.

- Rotate the adjuster to lower it so that it is in firm contact with the floor. If there is a gap between the pedals and the floor, the pedals may be damaged. In particular when placing the instrument on carpet, adjust this so that the pedals firmly contact the floor.

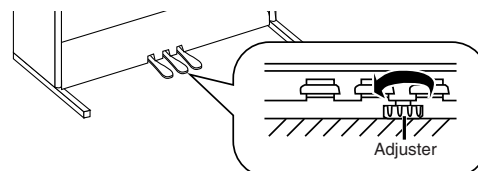

Chapter 1. Enjoying the Built-in Songs and Game

Listening to Built-in Songs

The HP-7/3 comes with 65 piano songs onboard.

■ Playing back all songs continuously (All Song Play)

The built-in songs can be played back consecutively.

MEMO

“Chapter 3. Playing Along with the Built-in Songs” (p. 25), “Tone List” (p. 41)

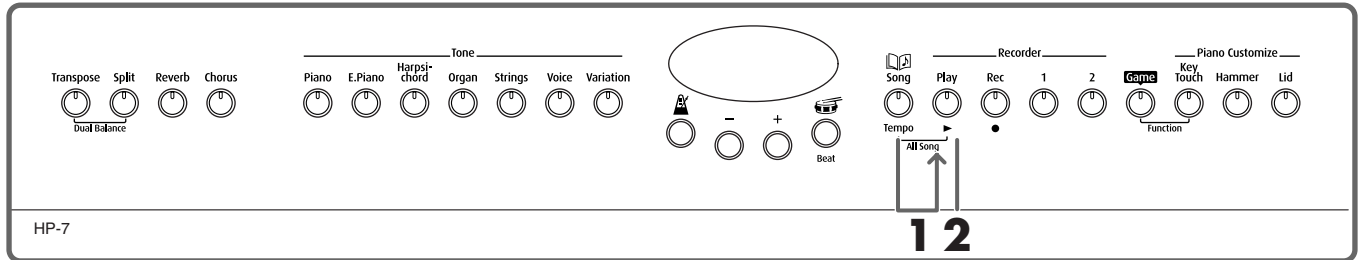

1 Hold down the [Song/Tempo] button, and press the [▶ (Play)] button.

The [Song/Tempo] button's indicator will light, the [▶ (Play)] button's indicator will blink, and the songs will play back successively, starting with the currently selected song.

The song number appears in the display.

You can press the [+] or [-] button to select the song that you want to play back.

When all songs have been played, playback will return to the first song and resume.

NOTE

It is not possible to sound the rhythm (p. 20) while a built-in song is playing.

Stopping the playback

2 Press the [▶ (Play)] button.

Playback will stop.

■ Selecting a song and playing it

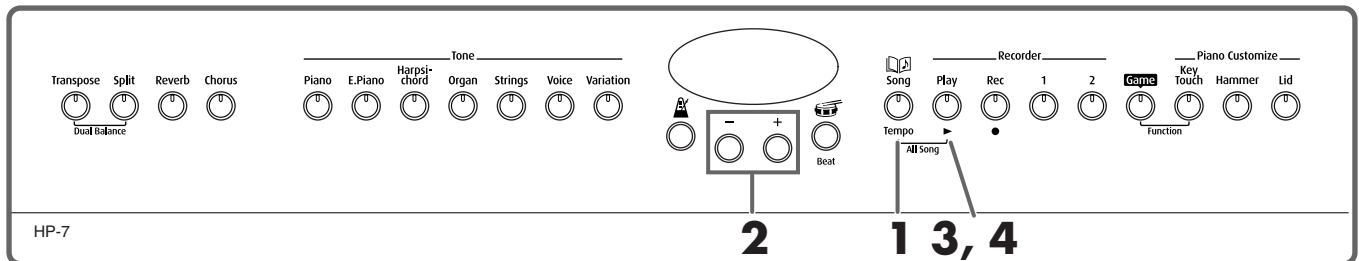

Choosing the song to play back

1 Press the [Song/Tempo] button, getting its indicator to light in red.

The song number appears in the display.



2 Press the [+] or [-] button to select a song.

Holding down the button causes the numbers to change continuously.

MEMO

About the display for the built-in songs

USr (user) ... The location where you can record your performance. (For details on recording → p. 28)

Numbers with a “d.” ... built-in songs.

Chapter 1. Enjoying the Built-in Songs and Game

Playing back

- 3 Press the [▶ (Play)] button.

The button's indicator will light, and the selected song will play.

Stopping the playback

- 4 Press the [▶ (Play)] button.

The button's indicator goes out, and playback stops.

The next time you press the [▶ (Play)] button, the song that was stopped is played from the beginning.

Playing the Note-guessing Game

Here's how to play the note-guessing game.

There are three levels of difficulty in the game— through 3.

When you begin the game, you start at level 1 ("L.1"). You can move up to the next level as soon as you've scored enough points.

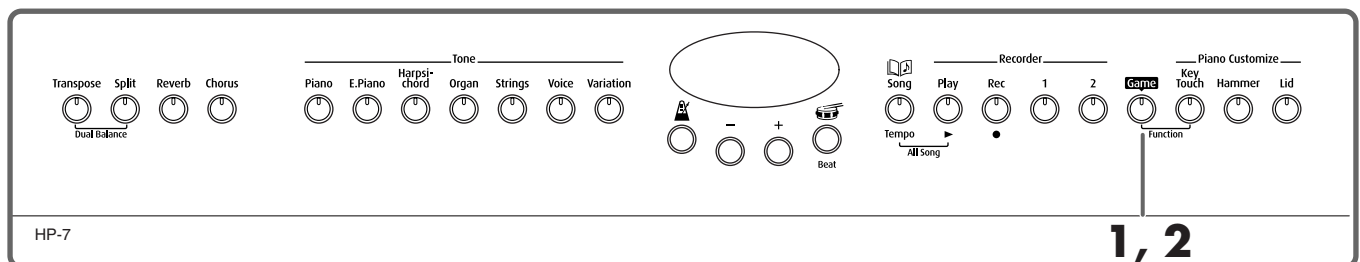

- 1 Press the [Game] button.

The button's indicator will light, and the game will begin.

1. First, the reference "C" (C4) note will sound.
2. The note for you to guess will sound.
Listen carefully, and play the key of the note that sounded.
When you play a key, the next note will sound.
There will be five notes for you to guess.
3. When you have answered all of them, your score will be displayed.
Once you achieve 80 or more points, you can proceed to the next level.

Ending the game

- 2 Press the [Game] button.

Even during the game, you can press the [Game] button to end the game.



Changing the level

When the level (L.1, L.2, L.3) is displayed, you can choose the level by pressing the [+] or [-] button.

Chapter 2. Performance

Performing with a Variety of Sounds

The HP-7 contains 24 different built-in tones. The tones are organized into six tone groups, which are assigned to the Tone buttons.

The HP-3 contains 20 different built-in tones. The tones are organized into five tone groups, which are assigned to the Tone buttons.

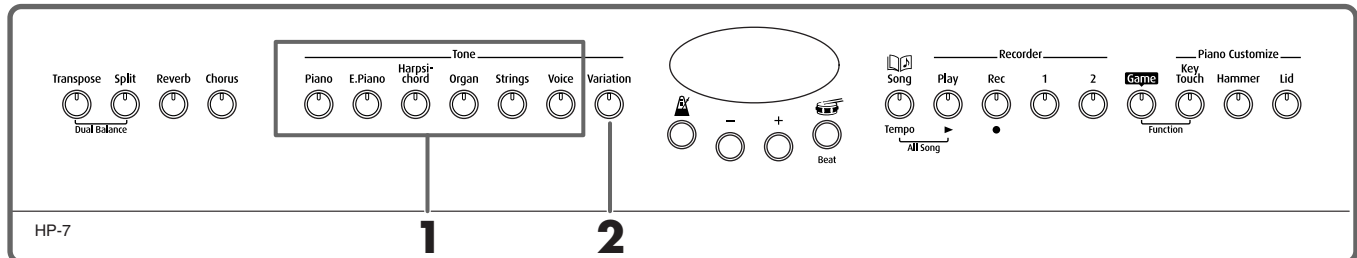

Selecting a tone group

1 Press any Tone button.

The indicator of the button you pressed will light.

When you play the keyboard, you will hear a sound in the selected tone group.

Selecting variation tones

2 Press the [Variation] button.

Four different tones (numbered 1–4) are assigned to each Tone button. Use the [Variation] button to select among them.

Each time you press the [Variation] button, the button's indicator will change color, and the four sounds will be selected successively.

Tone number	1	2	3	4
[Variation] button's indicator	Dark	Red	Green	Orange

Some of the number 3 and 4 tones form pairs, which can be layered and sounded together.

The tone you've selected is heard when you finger the keyboard.



For more details, refer to "Tone List" (p. 41).



When Dual performance (p. 16) or Split performance (p. 17) is used, only sound number 1 or 2 can be selected. If you use Dual performance or Split performance with a Tone button for which tone number 3 or 4 is selected, tone number 1 will be selected for that Tone button.

Playing Two Sounds Together (Dual Performance)

Simultaneously playing two tones when one key is pressed is called “Dual performance.”

1 Simultaneously press the two Tone buttons that you want to play together.

The indicator of the button you pressed will light.

When you play the keyboard, the tones of the two Tone buttons you selected will sound simultaneously.

To cancel Dual performance, press any Tone button.

To change the tone of the right button of the two selected tones

Press the [Variation] button.

Dual performance now features the tone of the left side’s tone button along with the newly selected tone.

To change the tone of the left button of the two selected tones

Cancel the Dual performance, and then re-select the tone.

■ Adjusting the volume balance in Dual performance (Dual Balance)

You can change the volume balance between the two layered sounds in Dual performance.



When Dual performance is used, the [Variation] button’s indicator will light to indicate the selection of the right button of the two selected tones.



When Dual performance is used, only sound number 1 or 2 can be selected.

If you use Dual performance with a Tone button for which tone number 3 or 4 is selected, tone number 1 will be selected for that Tone button.

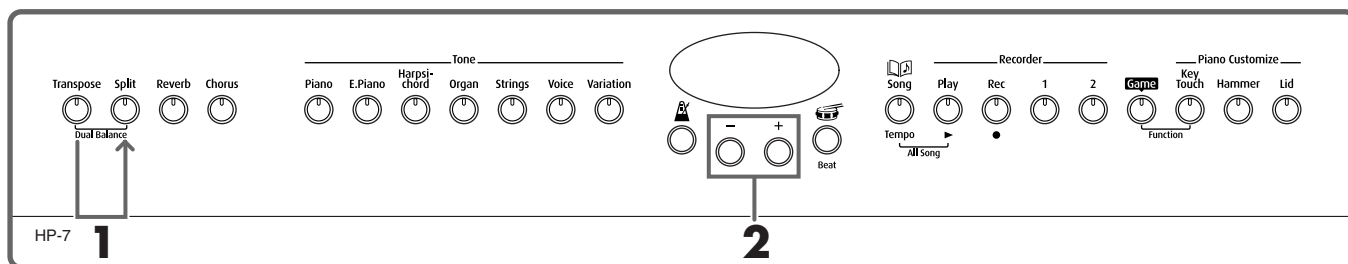

1 Hold down the [Transpose] button, and press the [Split] button.

The indicators of the buttons you pressed will blink.

The current volume balance appears in the display.

2 Press the [+] or [-] button to change the value.

To return to the original volume balance, press the [+] and [-] buttons simultaneously.



Volume of the left button tone Volume of the right button tone

Press any button other than the [+] [-] buttons, and the button’s indicator will return to the previous state.



When the power is turned on, this will be set to “8-2” (volume of the left button tone - volume of the right button tone).

Playing Different Tones with the Left and Right Hands (Split Performance)

Dividing the keyboard into right-hand and left-hand areas, then playing different sounds in each is called “Split performance.” The boundary key is called the “split point.”

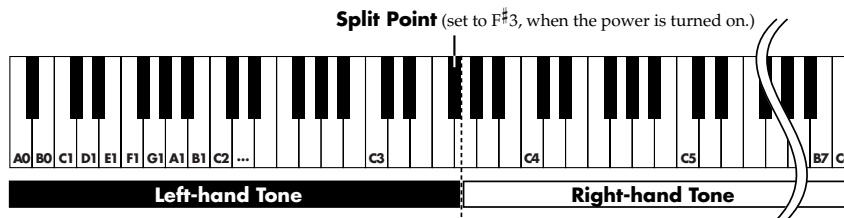

MEMO

The split point key is included in the left-hand keyboard area.

MEMO

When Split performance is used, only tone numbers 1 or 2 can be selected.

If you use Split performance with a Tone button for which tone numbers 3 or 4 selected, tone number 1 will be selected for that Tone button.

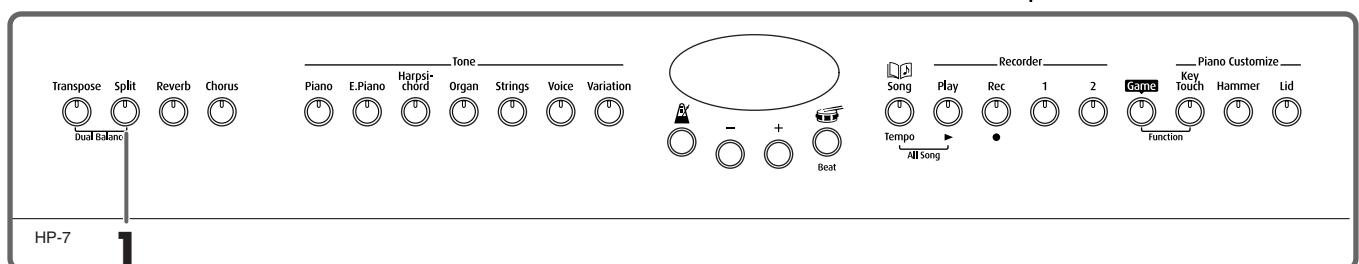

1 Press the [Split] button.

The button's indicator will light.

The keyboard is divided into right-hand and left-hand areas.

The tone you were playing before you pressed the [Split] button will be selected for the right-hand area, and a tone that is a suitable match for the right-hand tone (e.g., a bass tone) will be selected for the left-hand area.

To cancel Split performance, press the [Split] button, getting its indicator to go dark.

Changing tone played by the left hand

Press the [Variation] button.

Each time you press the [Variation] button, the button's indicator will change color, and the left-hand tone will change.

Some tones assign the tone that had been selected before you pressed the [Split] button to the left hand area of the keyboard.

Changing tone played by the right hand

Press the Tone button.

The tone of the right-hand area will change.

If you want to change the variation for the right-hand tone, cancel Split performance and then re-select the tone.

MEMO

When using Dual performance, press the [Split] button

The right hand will play the tone of the left button of Dual performance, and the left hand will play a suitable match for the right-hand tone.

MEMO

For information about the tones that can be selected for the left hand section, refer to the “Tone List” (p. 41).

MEMO

The selected left hand tone is remembered for each Tone button. When you turn off the power, it will return to the original setting.

MEMO

In Split performance, the damper pedal will be applied only to the right-hand area of the keyboard. If you want the damper pedal to be applied to the left-hand area, refer to “Applying the damper pedal to the left-hand keyboard area” (p. 35).

Chapter 2. Performance

■ Changing the keyboard's split point

You can change the location where the keyboard is divided (the split point) within the range of B1 through B6.

- 1 While continuing to hold the [Split] button, press the key that you want to specify as the split point.

The key you pressed becomes the split point, and belongs to the left-hand section of the keyboard.

You can also change the setting by pressing the [+] or [-] button while continuing to hold down the [Split] button.

If you hold down the [Split] button and simultaneously press the [+] and [-] buttons, the setting will return to its original value (F#3).

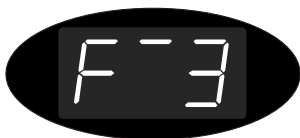

Using Metronome and Rhythm

■ Sounding the metronome

The HP-7/3 features a built-in metronome.

While a song plays back, the metronome will sound at the tempo and time signature (Beat) of that song.

MEMO

The setting is at "F#3" when the piano is powered up.

MEMO

The split point key is displayed as follows.

Display	C	d _♭	d	E _♭
Letter name	C	D _♭	D	E _♭
Display	E	F	F _♯	G
Letter name	E	F	F _♯	G
Display	A _♭	A	b _♭	b
Letter name	A _♭	A	B _♭	B

MEMO

When you continue holding the [Split] button, the currently specified split point value will be displayed.

MEMO

It is not possible to sound the metronome and rhythm (p. 20) simultaneously.

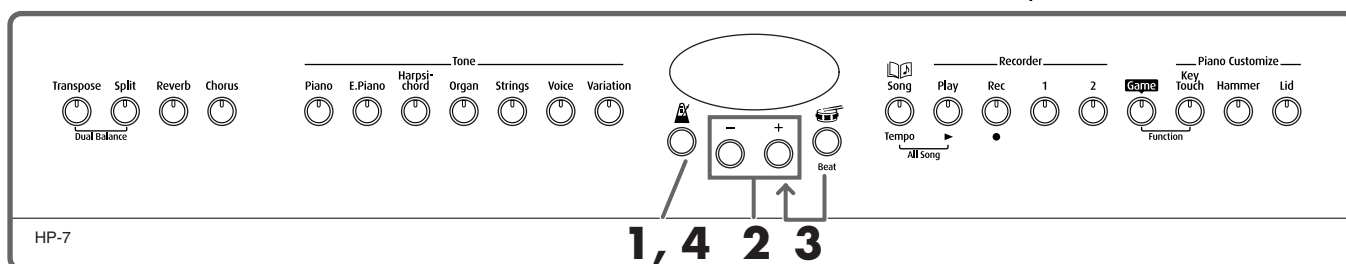

Sounding the metronome

- 1 Press the [ (Metronome)] button.

The metronome will sound.

The button's indicator flashes in red and green in time with the beat selected at that time. The indicator lights in red on the downbeats, and in green on weak beats.

Changing the tempo

- 2 Press the [+] or [-] button to adjust the tempo.

Changing the beat of metronome

3 Hold down the [ (Rhythm)/Beat] button, and press the [+] or [-] button.

The currently selected beat will be displayed.

If you hold down the [ (Rhythm)/Beat] button and press the [+] or [-] button, the beat will change.

If you hold down the [ (Rhythm)/Beat] button and press the [+] and [-] buttons simultaneously, the beat will go back to what it was before you changed it.



Display	beat	Display	beat
2.2	2/2	6.4	6/4
0.4	Only weak beats	7.4	7/4
2.4	2/4	3.8	3/8
3.4	3/4	6.8	6/8
4.4	4/4	9.8	9/8
5.4	5/4	12.8	12/8

Stopping the metronome

4 Once again press the [ (Metronome)] button, getting its indicator to go dark.

The metronome will stop.

■ Changing the metronome and rhythm volume

The volume of the metronome and rhythm (p. 20) can be adjusted, with eight volume levels available.

1 While holding down the [ (Metronome)] button, press the [+] or [-] button.

The currently specified volume will be displayed.

Continue to hold down the [ (Metronome)] button, and press the [+] or [-] button to sound the metronome or rhythm, and change the volume.





NOTE

It is not possible to change the beat during song playback or recording.

MEMO

Correspondence between beat and tempo display

Beat	Tempo Value
2/2	 =10-125
x/4	 =20-250
x / 8	 =40-500

MEMO

This is set to "4" when the instrument is turned on.

Chapter 2. Performance

■ Playing rhythm

The HP-7/3 contains 53 different rhythms.

The built-in rhythms can be sounded or stopped by pressing a button, in the same way as the metronome.

By playing the rhythm instead of the metronome, you can enjoy performing as if you were playing with a session-like feel.

Playing rhythm

- 1 Press the [ (Rhythm)/Beat] button.

The [ (Rhythm)/Beat] button's indicator will blink, and the rhythm will sound.

Changing the beat of rhythm

- 2 Continue to hold down the [ (Rhythm)/Beat] button, and press the [+] or [-] button.

The currently selected beat will be displayed.

If you hold down the [ (Rhythm)/Beat] button and press the [+] and [-] buttons simultaneously, the beat will go back to what it was before you changed it.



Changing the rhythm

- 3 Press the [+] or [-] button to select the rhythm.

If the display does not indicate the rhythm number (prefixed by "r."), press the [ (Rhythm)/Beat] button to display the rhythm number.

The currently selected rhythm number will be displayed.

The rhythms that can be selected will depend on the beat.



Changing the tempo

- 4 Press the [Song/Tempo] button, getting its indicator to light in green.

The tempo appears in the display.

- 5 Press the [+] or [-] button to adjust the tempo.

Stopping the rhythm

- 6 Press the [ (Rhythm)/Beat] button, getting its indicator to go dark.

The rhythm will stop.



It is not possible to sound the metronome and rhythm simultaneously.



It is not possible to sound the rhythm while a built-in song is playing back.

If you press the

[ (Rhythm)/Beat] button while a built-in song is playing back, the metronome will sound.



For details on the beat display, refer to the table on p. 19.



For details on the rhythm, refer to the "Rhythm List" (p. 44).

Applying Effects to the Sound

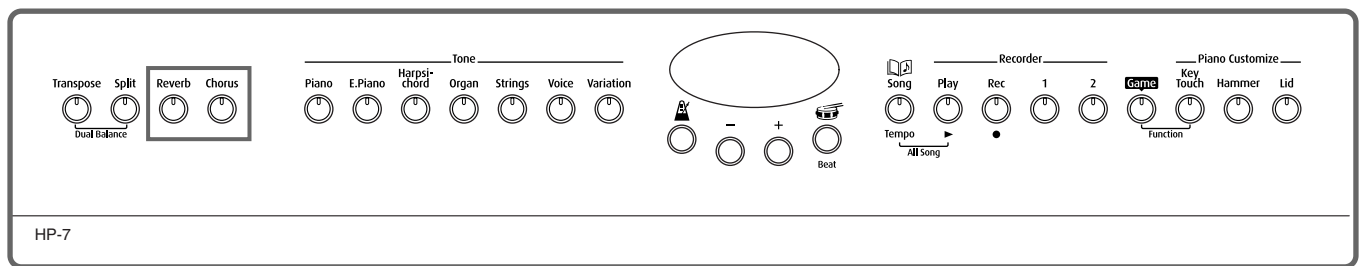

■ Adding reverberation to the sound (Reverb)

By applying the reverb effect you can produce a pleasant reverberation, making it sound as though you were performing in a concert hall.

1 Press the [Reverb] button.

The button's indicator will light, and a reverb effect will be applied to the sound.

To cancel the reverb effect, press the [Reverb] button, getting its indicator to go dark.

■ Adding richness to the sound (Chorus)

By adding the chorus effect, you can give the sound greater dimension, with more fatness and breadth.

1 Press the [Chorus] button.

The button's indicator will light, and a chorus effect will be applied to the sound.

To cancel the chorus effect, press the [Chorus] button, getting its indicator to go dark.

■ Changing the amount of effect applied

The depth of the reverb effect and chorus effect can be adjusted over eight steps.

Changing the depth of the reverb effect

1 Hold down the [Reverb] button and press the [+] or [-] button.

The currently specified value will be displayed.

Higher values will produce a deeper effect.

Changing the depth of the chorus effect

1 Hold down the [Chorus] button and press the [+] or [-] button.

The currently specified value will be displayed.

Higher values produce a deeper effect.



The reverb effect setting for each tone is not remembered.



When you play back a built-in song, the reverb effect will automatically be turned on (the button's indicator lights).



The chorus effect setting can be remembered for each tone. When you turn off the power, it will return to the original setting.



When using Split performance (p. 17), the chorus effect will not be applied to the left-hand bass tone of the keyboard (p. 41).



When the power is turned on, reverb is set to "4," and chorus to "4."



The depth of the reverb effect for each tone is not remembered.



The chorus effect depth setting of each tone can be remembered. When you turn off the power, it will return to the original setting.

Transposing the Key of the Keyboard (Transpose)

By using the “Transpose function,” you can transpose your performance without changing the notes you play. For example, even if the song is in a difficult key with numerous sharps (#) or flats (b), you can transpose it to a key that is easier for you to play.

When accompanying a vocalist, you can easily transpose the pitch to a range that is comfortable for the singer, while still playing the notes as written (i.e., with the same fingering positions).

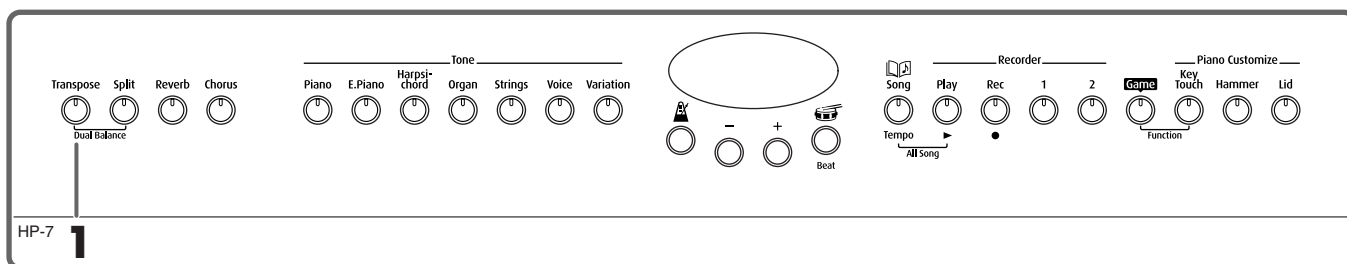

1 Continue to hold down the [Transpose] button, and press a note to indicate the tonic of the key to which you want to transpose.

The button’s indicator will light, and the keyboard will be transposed.

You can also transpose by holding down the [Transpose] button and pressing the [+] or [-] button.

If you hold down the [Transpose] button and press the [+] and [-] buttons simultaneously, the setting will return to the original value (0).

This can be set in a range of -6–0–5 (semitone steps).

For example, if you want the E pitch to sound when you play the C key, hold down the [Transpose] button and press the E key.

Counting from C as a reference point, one moves up four keys, including the black keys, to reach E, thus “4” appears in the display.

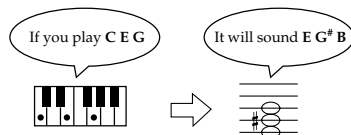

When the transpose value is set to “0,” the button’s indicator will remain dark even if you press the [Transpose] button.

To cancel the transpose function, press the [Transpose] button, extinguishing its indicator.

When you press the [Transpose] button once again, getting its indicator to light, the keyboard will be transposed to the note you specified here.



When you hold down the [Transpose] button, the currently specified value will be displayed.



This setting returns to the original value (0) when you turn off the power.

Adjusting the Keyboard Touch (Key Touch)

You can adjust the touch (playing feel) of the keyboard.

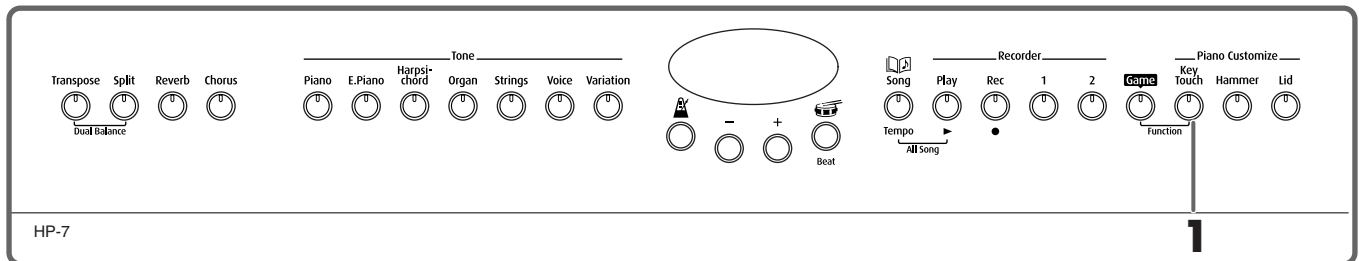

1 Press the [Key Touch] button.

The button's indicator will light, and the feel of the keyboard will change.

Each time you press the [Key Touch] button, the button's indicator will change color, and the feel of the keyboard will change.

Indicator	Settings	
OFF	Medium	This allows you to play using the most natural touch. This is the closest to the touch of an acoustic piano.
Red	Heavy	Fortissimo (ff) cannot be produced unless you play more strongly than usual, making the keyboard feel heavier. Dynamic fingering adds even more feeling to what you play.
Green	Light	Fortissimo (ff) can be produced by playing less strongly than usual, making the keyboard feel lighter. This setting makes it easy to play, even for children.
Orange	Fixed	Sounds at a fixed volume, regardless of your keyboard playing strength.

Making Fine Adjustments to the Piano Sound (Piano Customize) (HP-7)

You can make fine adjustments to the sound of the piano as desired.

[Hammer] Button

This adjusts how your playing strength will affect the timing at which the note sounds. This is called the “Hammer Response” function.

On an acoustic piano, pressing a key moves a hammer, which strikes a string to produce sound. If you press the key softly, the hammer will move slowly, meaning that it will take slightly longer (in comparison to a strongly-played note) from the moment you press the key until the sound is produced.

If the Hammer Response function is turned on, the time between the moment you press a key until the sound is heard will change depending on the strength with which you play. As you play more softly, this time will become longer.

[Lid] Button

This simulates the change in tone that occurs when the lid of a grand piano is opened or closed.

The lid can be adjusted over three positions. Opening the lid makes the tone brighter, and closing it makes the tone more mellow.

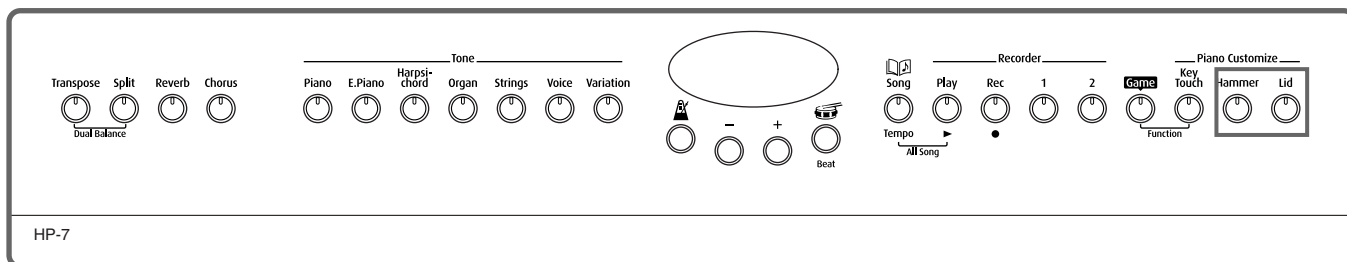

1 Press the [Hammer] button.

The button’s indicator will light, and the tone will change.

Indicator	Setting	
Dark	Off	
Red	1	Higher settings will produce a slower response when you play softly.
Green	2	
Orange	3	

2 Press the [Lid] button.

The button’s indicator will light, and the tone will change.

Indicator	Setting
Dark	The lid is open.
Red	The lid is closed, producing a softer tone.
Green	The lid is wide open, producing a bright tone.

Chapter 3. Playing Along with the Built-in Songs

Here's how you can play along with the built-in songs.

You can slow down the playback tempo of the song, or play back each hand separately.

Before you try playing the song, listen to it several times to get a general feel for the song.

For details on operation, refer to "Selecting a song and playing it" (p. 13).

Changing the Tempo

If the song has a rapid tempo, you can slow down the tempo so that you can practice it more easily. It is effective to gradually raise the tempo as you practice.



If you turn on the metronome while the song plays back, the metronome will sound at the beat and tempo of the song.

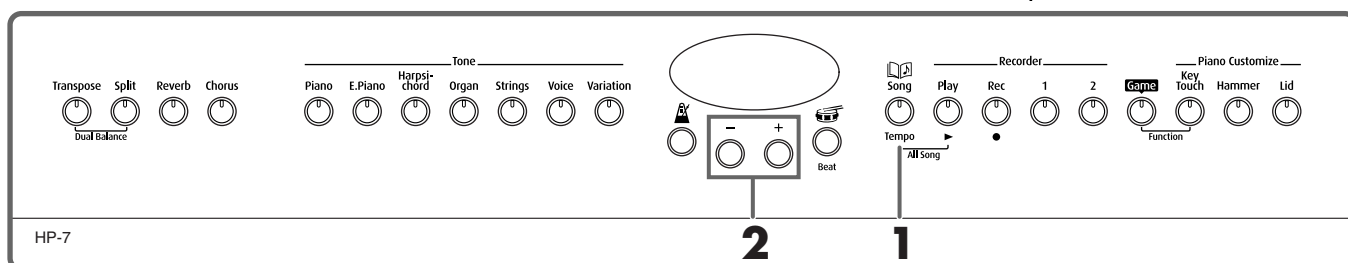

1 Press the [Song/Tempo] button, getting its indicator to light in green.

The tempo appears in the display.

Each time you press the [Song/Tempo] button, the tempo and the currently selected song number (prefixed by "d.") will be displayed alternately.

While the tempo is displayed, the [Song/Tempo] button indicator will light in green. While the song number is displayed, it will light in red.

2 Press the [+] or [-] button to adjust the tempo.

The tempo can be adjusted in a range of ♩=20-250.

You can also change the tempo during playback.

Pressing the [+] button once increases the tempo by one unit. Holding down the button increases the tempo continuously.

Pressing the [-] button once decreases the tempo by one unit. Holding down the button makes the tempo change (slow down) continuously.

If you press the [+] and [-] buttons simultaneously, you will return to the basic tempo of the song (the tempo before you modified it).

■ Adding a count-in to match the timing (Count-In)

When you're playing along with a song, you can make sure that your playing is in time with the song by sounding a count before the song starts playing.

Sounding a "count sound" leading up to playback of a song is called "Count-In."

On the HP-7/3, if you playback a song while the metronome is sounding, two measures of lead-in count will be heard at the beginning of the song.



Indication of the tempo during song playback

While the song is playing, the initial tempo of the song will continue to be displayed, regardless of tempo changes during the song.



During the count-in, the count measure is indicated in the display as "-2" then "-1."



"Sounding the metronome" (p. 18)

Playing Each Hand Separately

The built-in songs allow you to select the performance part that will be played back. The left-hand performance of the built-in songs is assigned to the [1] button, while the right-hand performance is assigned to the [2] button. The place where each part of the performance is held is called a “track,” and the [1] and [2] buttons are called “track buttons.”

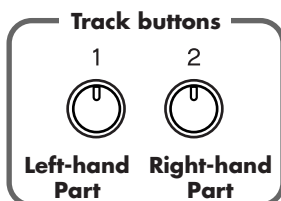

Here's how to practice each hand separately along with the song.

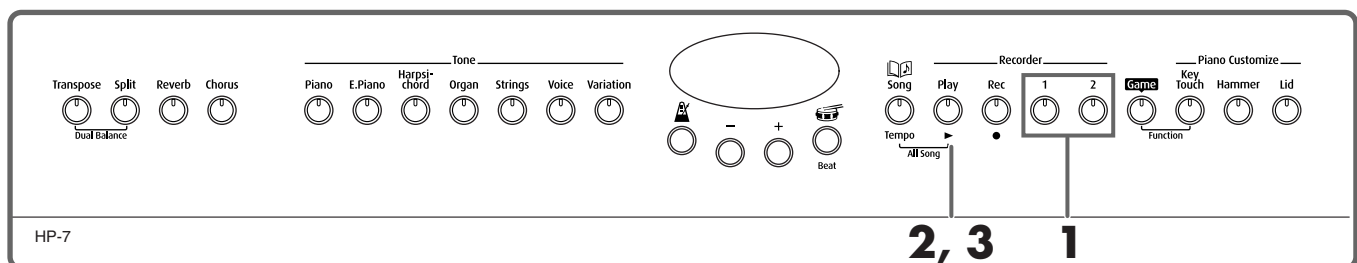

First select the song that you want to play back (p. 13).

Selecting the part that you yourself will play

1 Press the [1] or [2] button.

The indicator of the button you've pressed goes out, and the sound of the selected part will no longer be heard.

For example, if you want to practice the right hand, press button [2] and get its indicator to go dark.

When you play back the song, the right-hand performance will not sound. Practice your right-hand performance along with the left-hand playback.

Playing back a song

2 Press the [▶ (Play)] button.

The song will begin playing back.

The part you selected in step 1 will not sound.

Once again press the button you selected in step 1. The button's indicator will light, and the sound will be heard once again.

Even while the song is playing, you can press the track buttons to mute or un-mute the sound.

Stopping the song

3 Press the [▶ (Play)] button.

The song will stop.

Chapter 4. Recording Your Performance

You can easily record your performances.

A recorded performance can be played back to hear your own playing, or to add additional parts.

The following types of recording can be done using the HP-7/3.

- Recording just your own keyboard performance (→ “Recording a New Song” (p. 28))
- Recording along with the rhythm (→ p. 29)
- Recording along with a built-in song (→ “Recording Along with a Song” (p. 30))
- Recording each hand separately (→ “Selecting and Recording the Track for Each Hand Separately” (p. 31))

■ Notes regarding recording

- Only one song can be recorded.
- Recorded performances are erased when the power is turned off. If you want to keep your performance, you can either record it on an external audio device, or use an external MIDI device to save the performance data on a floppy disk. For details, refer to “Chapter 6. Connecting External Devices” (p. 36).

If you see the following...

If you attempt to record using a different built-in song when a performance has already been recorded, the following will appear, and the [● (Rec)] button's indicator will blink.



If it is OK to erase the performance, press the [● (Rec)] button.

If you do not want to erase the performance, press the [► (Play)] button.

Recording a New Song

Record only the keyboard performance without playing along with a built-in song or rhythm.

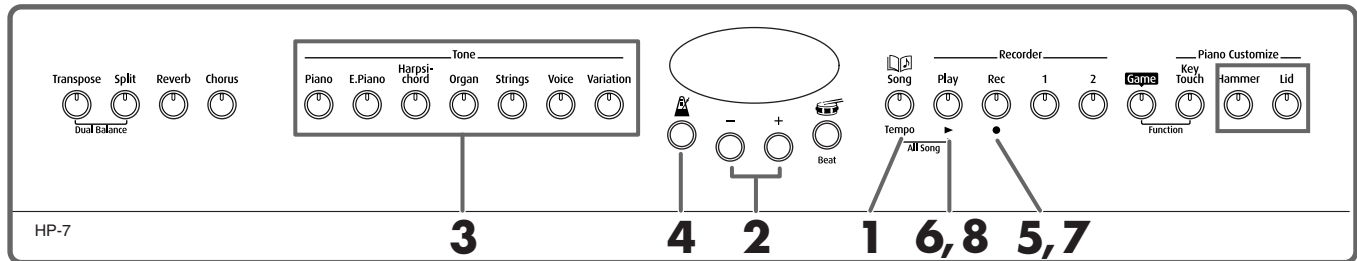

Recording settings (select "USr")

- 1** Press the [Song/Tempo] button, getting its indicator to light in red.
The song number appears in the display.
- 2** Press [+] and [-] buttons simultaneously, and "USr" appears in the display.

Specifying the tone and tempo for recording

- 3** Select the tone that you want to play (p. 15).
- 4** If necessary, turn on the metronome.
Sound the metronome while you set the tempo and beat of the song (p. 18).
- 5** Press the [● (Rec)] button.

The [● (Rec)] button's indicator will light, the [▶ (Play)] button's indicator will blink, and you will be in recording-standby mode.

Start recording

- 6** Recording will start when you either press the [▶ (Play)] button or play the keyboard.
The HP-7/3 counts down two measures, then recording starts.
Note that recording will also begin as soon as you play anything on the keyboard, even if you do not press the [▶ (Play)] button. There is no count sound played when you start in this manner.
When recording begins, the [▶ (Play)] button and [● (Rec)] button indicators will light. Go ahead and perform on the keyboard.

Stop recording

- 7** Press the [▶ (Play)] or [● (Rec)] button.

The indicators for the [▶ (Play)] and [● (Rec)] buttons will go dark.

Play back the recorded performance

- 8** Press the [▶ (Play)] button.

You will hear the recorded performance.

Once again press the [▶ (Play)] button, and playback will stop.

NOTE

If you layer a newly recorded performance without erasing the recorded song, the song tempo and beat will be stored with the settings that were recorded first.

NOTE

A performance that was recorded without using rhythm cannot be played back with the rhythm.
If you want to record along with the rhythm, refer to p. 29.

MEMO

About the "USr" display

When you stop recording, the "USr" display will change to "USr".

The "." in the lower right of the display indicates that there is already a recorded performance.

MEMO

If you record without specifying the recording track, the performance will be recorded to the [1] button.
If you want to record the right and left hands separately on separate recording tracks, refer to "Selecting and Recording the Track for Each Hand Separately" (p. 31).

Recording Along with the Rhythm

You can record a performance that uses the Rhythm function.

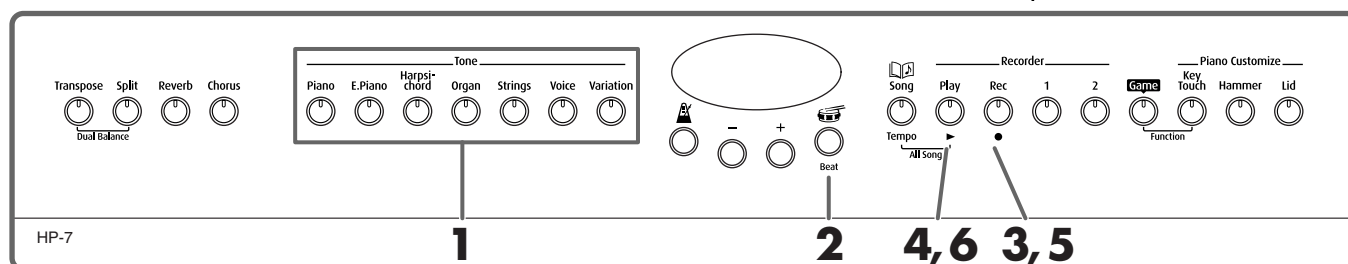

As described in steps **1** and **2** of “Recording a New Song” (p. 28), select the song “USr” before you continue.

Selecting the tone and rhythm for recording

- 1** Select the tone that you want to play (p. 15).
- 2** Press the [(Rhythm)/Beat] button, getting its indicator to blink.

The rhythm will sound. Set the rhythm and the tempo so that you can play comfortably (p. 20).

- 3** Press the [(Rec)] button.

The [(Rec)] button’s indicator will light, the [(Play)] button’s indicator will blink, and you will be in recording-standby mode.

Start recording

- 4** Press the [(Play)] button.

Recording begins after two measures of count sound.

Note that recording will also begin as soon as you play anything on the keyboard, even if you do not press the [(Play)] button. There is no count sound played when you start in this manner.

Begin recording your performance along with the rhythm.

Stop recording

- 5** Press the [(Play)] or [(Rec)] button.

Recording will stop, and the indicators for the [(Play)] and [(Rec)] buttons will go dark.

Play back the recorded performance

- 6** Press the [(Play)] button.

You will hear the recorded performance.

Once again press the [(Play)] button, and playback will stop.

If the rhythm does not sound when you play back the recorded performance

Is the [(Rhythm)/Beat] button on (button’s indicator blinking)?

If you want to play back the performance using rhythm, turn on the

[(Rhythm)/Beat] button.

NOTE

If you record additional material without erasing the previously-recorded song, the song tempo and beat will be stored with the settings that were first recorded.

NOTE

A performance you’ve recorded using rhythm cannot be played back with the metronome.

Recording Along with a Song

You can record a performance that you play along with a built-in song.

Using the [1] or [2] buttons, you can (for example) perform and record just the right-hand part of a song while listening to the left-hand playback of a built-in song.

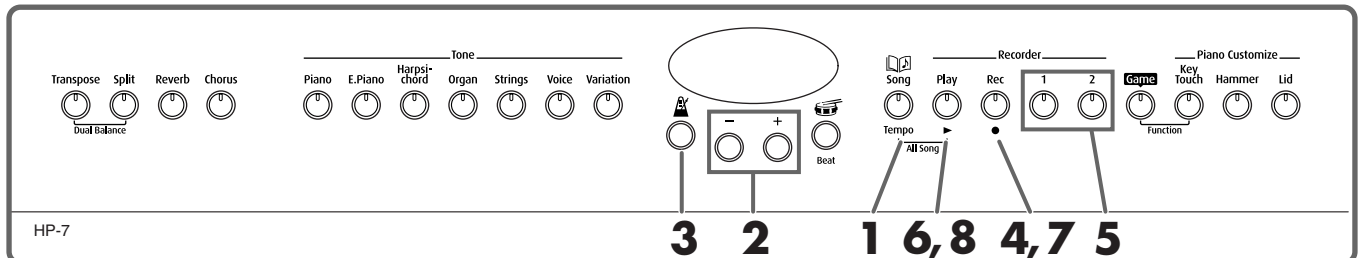

Selecting the song to record

- 1** Press the [Song/Tempo] button, getting its indicator to light in red.

The display will indicate the song number.

- 2** Use the [+] or [-] button to select the song that you want to play.

- 3** As necessary, set the metronome and tempo (p. 18).

- 4** Press the [● (Rec)] button.

The [● (Rec)] button's indicator will light.

Selecting the track to record

- 5** Press the [1] or [2] button.

When you want to record the left-hand performance, press the [1] button; to record that of the right hand, press the [2] button.

The indicators of the button you pressed and of the [▶ (Play)] button will blink, and the HP-7/3 enters recording-standby mode.

Starting to record

- 6** Press the [▶ (Play)] button.

Recording begins after two measures of count sound.

Play along with the song.

Stop recording

- 7** Press the [▶ (Play)] or [● (Rec)] button.

Recording will stop, and the indicators for the [▶ (Play)] and [● (Rec)] buttons will go dark.

The recorded performance is stored in "USr (User)."

Play back the recorded performance

- 8** Press the [▶ (Play)] button.

You will hear the recorded performance.

Once again press the [▶ (Play)] button, and playback will stop.



If "dEL" appears in the display, refer to p. 27.



A performance recorded using a built-in song cannot be played back with the rhythm.

Selecting and Recording the Track for Each Hand Separately

The recorder of the HP-7/3 has two recording tracks, allowing you to record the right and left hands separately. Use the [1] button or [2] button to specify the recording track.

If you want to re-do the recording, you can re-record just a specific track.

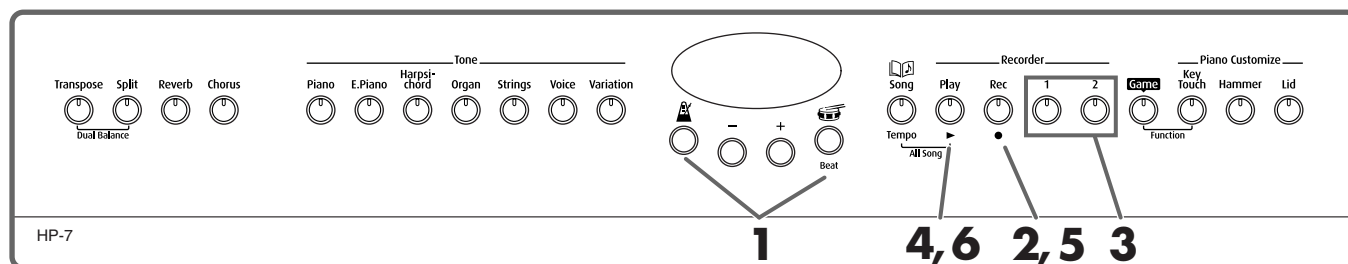

As described in steps **1** and **2** of “Recording a New Song” (p. 28), select “USr” before you continue.

1 As necessary, turn on the metronome or rhythm (p. 18).

2 Press the [● (Rec)] button.

The [● (Rec)] button’s indicator will light.

The button indicators of tracks that are already recorded will light.

The track button for which you will next be recording will be blinking.

Selecting the track to record

3 Press the [1] or [2] button to select the track that you want to record.

The indicator of the button you pressed will blink, and the HP-7/3 enters recording-standby mode.

Start recording

4 Press the [► (Play)] button.

Go ahead and perform on the keyboard.

Note that recording will also begin as soon as you play anything on the keyboard, even if you do not press the [► (Play)] button. There is no count sound played when you start in this manner.

Stop recording

5 Press the [► (Play)] or [● (Rec)] button.

Recording will stop, and the indicators for the [► (Play)] and [● (Rec)] buttons will go dark.

Your performance has been recorded to the specified track button.

If you want to record on the other track, return to step 2 to record your performance again. You can record while you listen to the previously recorded performance.

Play back the recorded performance

6 Press the [► (Play)] button.

You will hear the recorded performance.

Press the [► (Play)] button once again, and playback will stop.

NOTE

If you go on to record additional material without erasing the recorded song, the song tempo, beat, rhythm, and metronome settings of the original recording will be used for the new material as well.

MEMO

The track buttons allow you to record to either the [1] or the [2] button, one at a time.

Erasing Recorded Performances

You can erase a recorded performance.

■ Erasing a performance from the specified track

You can select a recorded track and erase it.

- 1 Hold down either the [1] or [2] button, and press the [● (Rec)] button.

The indicator of the button you pressed will go dark, and the performance of the selected track will be erased.

■ Erasing a song

You can erase a song you've recorded.

- 1 Hold down the [Song/Tempo] button and press the [● (Rec)] button.

The following display will appear, and the [● (Rec)] button's indicator will blink.



- 2 Once again press the [● (Rec)] button.

The recorded performance is erased.

If you decide not to erase the performance, press the [► (Play)] or [Song/Tempo] button.

Chapter 5. Changing Various Settings

Changing the Damper Pedal's Resonance

On an acoustic piano, depressing the damper pedal makes the notes you play resonate with other strings, adding rich reverberations and fatness to the sound. The damper pedal on the HP-7/3 recreates this resonance (sympathetic resonance) when depressed.

You can select from eight levels of depth for the resonant sound (resonance level).

This is set to "5" when the instrument is turned on.

* This setting is valid only for some piano tones. It cannot be made for other tones.

1. Hold down the [Reverb] button and [Chorus] button, and press the [-] or [+] button.

The currently specified value will be displayed.

Larger values will produce a deeper effect.



Making Detailed Settings (Function)

You can make performance-related settings such as tuning and temperament.

How to enter function mode

1. Hold down the [Game] button, and press the [Key Touch] button.

The indicators of the buttons you pressed will blink, and you will enter function mode.

The display will indicate the value of the currently selected function.

Setting the various functions

2. Press the button to which the desired function is assigned.

The indicator of the button you pressed will blink.

Button	Function	Page
[Piano]	Master Tuning	p. 34
[E. Piano]	Temperament	p. 34
[Harpichord]	Stretch Tuning	p. 35
[Organ]	Applying the damper pedal to the left-hand keyboard area	p. 35
[Strings]	MIDI send channel	p. 38
[Variation]	Local Control	p. 38
[▶ (Play)]	Transmitting a recorded performance	p. 38

For details on each function, refer to the explanations below.

3. Press the [+] or [-] button to change the value.

If you press the [+] and [-] buttons simultaneously, the value will return to the power-up default setting.

How to exit function mode

4. Press the [Game] or [Key Touch] button.

The button's indicator will return to the previous state.

Chapter 5. Changing Various Settings

■ Tuning to other instruments' pitches (Master Tuning)

In situations such as when playing ensemble with other instruments, you can tune the HP-7/3's reference pitch to the pitch of another instrument. The standard pitch generally refers to the pitch of the note that's played when you finger the middle A key. This tuning of all the instruments to a standard pitch is called "tuning."

If you press the **[Piano]** button in step 2 of "Making Detailed Settings (Function)" (p. 33), a display like the following will appear.



The last three digits are indicated in the display. "440.0 Hz" is indicated in the figure above.

Value 415.3 Hz–440.0 Hz–466.2 Hz

Power-up default setting 440.0 Hz

This setting remains in effect until you turn off the power.

■ Changing the temperament

You can play classical styles such as Baroque using historic temperaments (tuning methods).

Today, compositions are generally created with equal temperament in mind and are played using equal temperament. However in past ages of classical music, a variety of temperaments were used. Playing a composition with its original tuning lets you enjoy the sonorities of the chords that the composer originally intended.

If you press the **[E.Piano]** button in step 2 of "Making Detailed Settings (Function)" (p. 33), a display like the following will appear.



Temperament Tonic

You can choose from among the seven temperaments described below.

Display	Temperament	Qualities
1	Equal	In this tuning, each octave is divided into twelve equal steps. Every interval produces about the same amount of slight dissonance. This setting is in effect when you turn on the power.

Display	Temperament	Qualities
2	Pythagorean	This tuning, devised by the philosopher Pythagoras, eliminates dissonance in fourths and fifths. Dissonance is produced by third-interval chords, but melodies are euphonious.
3	Just Major	This tuning eliminates ambiguities in the fifths and thirds. It is unsuited to playing melodies and cannot be transposed, but is capable of beautiful sonorities.
4	Just Minor	The Just tunings differ from major and minor keys. You can get the same effect with the minor scale as with the major scale.
5	Mean Tone	This scale makes some compromises in just intonation, enabling transposition to other keys.
6	Werckmeister	This temperament combines the Mean Tone and Pythagorean tunings. Performances are possible in all keys (first technique, III).
7	Kirnberger	This is an improvement of the Mean Tone and Just tunings that provides a high degree of freedom of modulation. Performances are possible in all keys (III).

Power-up default setting 1 C

Tonic

When playing with tuning other than equal temperament, you need to specify the keynote for tuning the song to be performed (that is, the note that corresponds to C for a major key or to A for a minor key).

While hold down the **[E. Piano]** button, and press a note to specify the desired tonic key.

The tonic note you specify will be displayed as follows.

Display	C	d _~	d	E _~	E	F	F ⁻	G	A _~	A	b _~	b
Letter name	C	D ^b	D	E ^b	E	F	F [#]	G	A ^b	A	B ^b	B

If you choose an equal temperament, there's no need to select a keynote.

* If you record with a temperament other than equal temperament selected, and then want to play back that performance, use this setting to select the same temperament for playback as the temperament you used when recording.

* When performing in ensemble with other instruments, be aware that depending on the key, there may be some shifting of the pitch. Tune the HP-7/3 to the fundamental pitch of the other instruments.

■ Setting the tuning curve (Stretch Tuning)

A piano is generally tuned to a pitch with a lower bass range and a higher treble range than equal temperament. This special tuning method for pianos is called "Stretch Tuning."

If you press the **[Harpichord]** button in step 2 of "Making Detailed Settings (Function)" (p. 33), a display like the following will appear.



Values

- OFF This is the standard tuning curve. This is the right choice when using Dual performance (p. 16), or when playing in ensemble with other instruments.
- On This tuning curve expands the bass and treble ends somewhat. It is suitable for performances such as piano solos. This setting is in effect when you turn on the power.

Power-up default setting On

→ This effect works only with the piano tones.

■ Applying the damper pedal to the left-hand keyboard area

When you are using Split performance (p. 17), you can apply the damper pedal effect to the sound played by the left-hand keyboard range.

If you press the **[Organ]** button in step 2 of "Making Detailed Settings (Function)" (p. 33), a display like the following will appear.



Values

- On The damper pedal effect will be applied to the sound of the left and right hand keyboard area.
- OFF The damper pedal effect will not be applied to the sound of the left-hand keyboard area.

Power-up default setting OFF

Disabling Everything Except Piano Play (Panel Lock)

The "Panel Lock" function locks the HP-7/3 in a state where only piano performance can be used, and all buttons will be disabled. This prevents the settings from being inadvertently modified even if children press the buttons accidentally.

In the Panel Lock state, only the grand piano sound can be played.

1. Turn the volume to the minimum, and press the [Power] switch to turn off the power.
2. Hold down the [Piano] button, and press the [Power] switch to turn on the power.

Then, continue to hold down these two buttons for a few seconds.

The following display will appear.

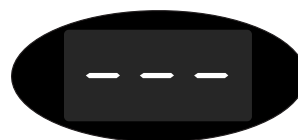

All buttons are disabled.

Adjust the volume.

When you play the keyboard, the grand piano sound will be heard.

To defeat the Panel Lock function, turn the volume down to the minimum, and turn on the power once again.

Chapter 6. Connecting External Devices

Connecting to Audio Equipment

You can connect audio devices to play the sound of the HP-7/3 through the speakers of your audio system, or to record your performance on a tape recorder or other recording device.

When connecting, please use an audio cable with a standard phone plug (sold separately).

Connection examples

* To prevent malfunction and/or damage to speakers or other devices, always turn down the volume, and turn off the power on all devices before making any connections.

Playing the sound of the HP-7/3 through the speakers of an audio system/Recording the performance of the HP-7/3 on a recording device

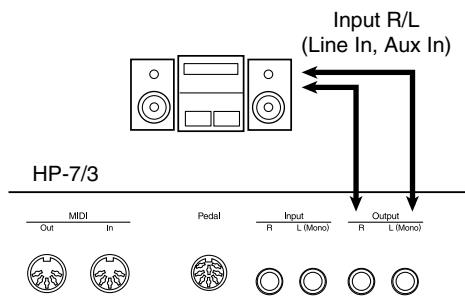

○ Use the following procedure when turning on the power.

1. Turn on the power of the HP-7/3.
2. Turn on the power of the connected device.
3. Adjust the volume of each device.

When Recording HP-7/3 Performances on a Recording Device

4. Start recording with the connected device.
5. Perform on the HP-7/3.
6. When the performance ends, stop recording on the connected equipment.

Playing the sound of an audio device through the speakers of the HP-7/3

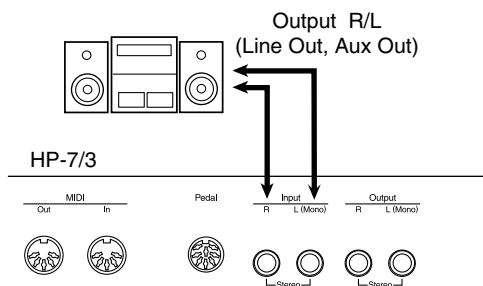

○ Use the following procedure when turning on the power.

1. Turn on the power of the connected device.
2. Turn on the power of the HP-7/3.
3. Adjust the volume of each device.

Turning off the power

1. Set the volume of the HP-7/3 and of the connected devices to the minimum position.
2. Turn off the power to the HP-7/3.
3. Turn off the connected equipment.

Connecting to a Computer

You can use a USB MIDI interface cable (sold separately) to connect the HP-7/3 to your computer.

If the HP-7/3 is connected to a computer in which sequencer software such as Roland's "Visual MT" is installed, a song you've recorded on the HP-7/3 can be saved on your computer.

Connection examples

* To prevent malfunction and/or damage to speakers or other devices, always turn down the volume, and turn off the power on all devices before making any connections.

* In order to make connections to your computer, you must install "MIDI driver" software on your computer. For details, refer to the owner's manual for your MIDI interface.

Use a USB MIDI interface cable to connect the USB connector of your computer to the MIDI connectors of the HP-7/3.

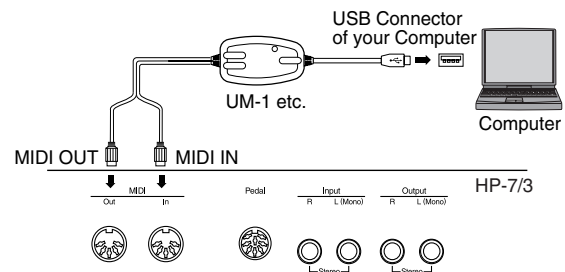

Connecting MIDI Devices

By connecting an external MIDI device and exchanging performance data, you can control the performances on one device from the other. For instance, you can output sound from the other instrument or switch tones on the other instrument.

■ What's MIDI?

MIDI stands for Musical Instrument Digital Interface, an international standard which allows performance information to be communicated among electronic musical instruments and computers.

The HP-7/3 provides MIDI connectors, which allow performance data to be exchanged with external devices. When these connectors are used to connect the HP-7/3 to external devices, an even wider range of possibilities becomes available.

* A separate publication titled "MIDI Implementation" is also available. It provides complete details concerning the way MIDI has been implemented on this unit. If you should require this publication (such as when you intend to carry out byte-level programming), please contact the nearest Roland Service Center or authorized Roland distributor.

Connection examples

* To prevent malfunction and/or damage to speakers or other devices, always turn down the volume, and turn off the power on all devices before making any connections.

Playing the HP-7/3 from a MIDI sequencer/ Recording an HP-7/3 performance on a MIDI sequencer

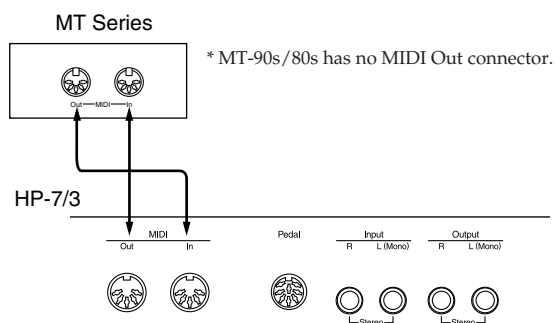

* Set Local Off if you have connected the HP-7/3 to a MIDI sequencer. Refer to "Switching Local Control on and off" (p. 38). Also set your MIDI sequencer to MIDI Thru mode (so that messages received at MIDI IN will be re-transmitted without change from MIDI OUT). For details, refer to the owner's manual of your MIDI sequencer.

Perform on the HP-7/3 to play a MIDI sound generator

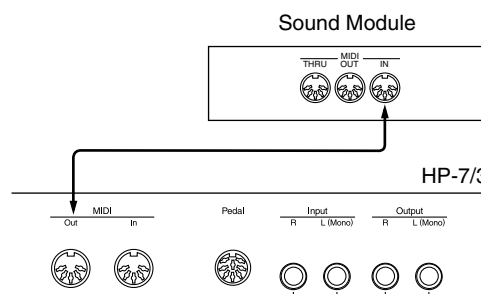

Making MIDI-related Settings

Here's how you can set the transmit channel and other MIDI-related settings.

How to enter function mode

1. Hold down the [Game] button, and press the [Key Touch] button.

The indicators of the buttons you pressed will blink, and you will enter function mode.

The display will indicate the value of the currently selected function.

Setting various functions

2. Press the button to which the desired function is assigned.

The indicator of the button you pressed will blink.

For details on the contents of each function, refer to the explanations that follow.

3. Press the [+] or [-] button to change the value.

If you press the [+] and [-] buttons simultaneously, the setting will return to the original value.

How to exit function mode

4. Press either the [Game] button or [Key Touch] button.

The button's indicator will return to the previous state.

Chapter 6. Connecting External Devices

■ MIDI send channel settings

MIDI features sixteen MIDI channels, numbered 1–16. Simply connecting a cable is not enough for communication to take place. The connected devices must be set to use the same MIDI channels. Otherwise, no sound will be produced, and no sounds can be selected.

- * The HP-7/3 receives all channels 1–16.
- * If you are using Dual performance (p. 16) or Split performance (p. 17) on the HP-7/3, only the channel you specify here will be transmitted.

If you press the **[Strings]** button in step 2 of “Making MIDI-related settings,” a display like the following will appear.



Value 1–16

Power-up default setting 1

■ Switching Local Control on and off

When connecting a MIDI sequencer, set Local Control to “Off.”

As illustrated, information describing what has been played on the keyboard is passed to the internal sound generator over two different routes, (1) and (2). As a result, you hear overlapping or intermittent sounds. To prevent this from happening, route (1) must be severed, by setting the unit to what is known as “Local Off.”

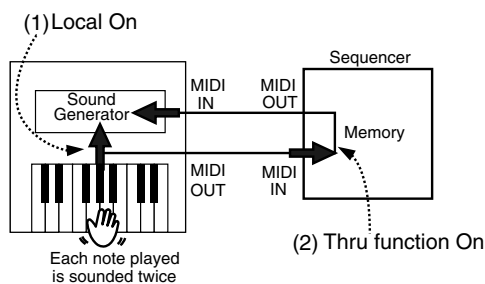

Local Control ON: The keyboard and the internal sound generator are in a linked state.

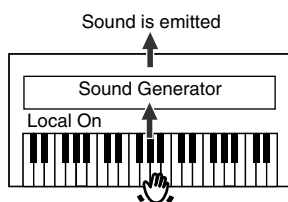

Local Control OFF: The keyboard and the internal sound generator are in an unlinked state. No sound will be produced by the keyboard when it is played.

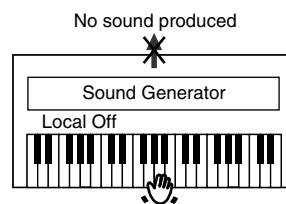

- * When a Roland MT series instrument is connected, it is not necessary to make the Local Off setting. MT units transmit Local Off messages when their power is switched on. If you turn on the power in the order of the HP-7/3 → MT series, Local Off will be set automatically.

If you press the **[Variation]** button in step 2 of “Making MIDI-related settings,” a display like the following will appear.



Value On, OFF

Power-up default setting On

■ Transmitting a performance you recorded

If you want to transmit a performance recorded on the HP-7/3 to an external MIDI device or computer, turn this setting “On.” If this is “Off,” the data will not be transmitted.

If you press the **[▶ (Play)]** button in step 2 of “Making MIDI-related settings,” a display like the following will appear.



Value On, OFF

Power-up default setting OFF

If you wish to save the performance, use the following procedure. In this situation, your external sequencer is set its MIDI Thru feature to be OFF. For details, refer to the owner’s manual of your MIDI sequencer.

- 1 Connect a MIDI sequencer such as the MT series (p. 37).
- 2 Record the performance on the HP-7/3 (p. 27).
- 3 Set this setting to “On.”
- 4 Start recording with the connected MIDI device.
- 5 Start playback of the recorded song on the HP-7/3.
- 6 When playback ends, stop recording with the connected MIDI device.
- 7 Use a connected MIDI sequencer to save the data on a floppy disk or other media.

Troubleshooting

If you think there's a problem, read this first.

Case	Cause/Remedy
The power doesn't come on	Is the power cord connected and plugged in correctly? (p. 10)
The button doesn't work	Is the panel locked? (p. 35) Turn the power off, then back on.
No sound is heard	Is the volume level of the HP-7/3 turned all the way down? (p. 12)
	Are headphones plugged in? (p. 11) Has a plug remained connected to the Phones jack? When headphones are connected, the keyboard's speaker stops playing.
	Is Local Off selected? When Local Control is set to OFF, no sound is produced by playing the keyboard. Set Local Control to "ON" (p. 38)
No sound is heard (when a MIDI instrument is connected)	Have all devices been switched on?
	Are the MIDI cables connected correctly?
	Does the MIDI channel match the connected instrument? (p. 38)
Sounds are heard twice (doubled) when the keyboard is played	Is the HP-7/3 in Dual performance? (p. 16)
	When the HP-7/3 is connected to an external sequencer, set it to the Local OFF mode (p. 38). Alternatively, the sequencer could be set so its MIDI Thru feature is OFF.
The tone has changed in the Split or Dual performance	If you use Dual performance or Split performance with a Tone button for which tone number 3 or 4 is selected, tone number 1 will be selected for that Tone button (p. 15).
	Some tones assign the tone that had been selected before you pressed the [Split] button to the left hand area of the keyboard. Please refer to "Tone List" (p. 41).
Tone doesn't change	Is the panel locked? (p. 35) Turn the power off, then back on.
	Are the indicators for the [Game] and [Key Touch] buttons flashing? Setting of functions is in progress. Press the [Game] or [Key Touch] button to exit function mode (p. 33, p. 37).
Not all played notes are sounded	The maximum number of notes that the HP-7/3 can play simultaneously is 64. Frequent use of the damper pedal when playing along with a song may result in performance data with too many notes, causing some notes to drop out.

Case	Cause/Remedy
The tuning or pitch of the keyboard or song is off	Have you set Transpose? (p. 22)
	Are the settings for the "Temperament" and "Stretch Tuning" correct? (p. 34)
	Is the setting for the "Master Tuning" correct? (p. 34)
Song doesn't play back/ Only the sound of a particular instrument in a song does not play	Are the indicator for the Track buttons ([1] and [2] buttons) extinguished? (p. 26) If the button indicator is out, the music on that track is not heard. Press the track button so the indicator is illuminated.
Rhythm doesn't sound	It is not possible to sound the rhythm while a built-in song is playing back or recording.
	A performance that was recorded without using rhythm cannot be played back with the rhythm.
Metronome doesn't sound	A performance you've recorded using rhythm cannot be played back with the metronome.
Can't record	Has one of the track buttons for recording been selected? (p. 29–p. 31)
Tempo of recorded song or metronome is off	If you select an built-in song in which the tempo changes during the song, and then record, the tempo will change in the same way for the performances. The tempo of the metronome will also change in the same way.
	If you record additional material without erasing the previously recorded song, the song will be recorded at the first-recorded tempo. Please erase the previously recorded song before you re-record. (p. 32)
The recorded performance has disappeared	Any performance that has been recorded is deleted when the power to the HP-7/3 is turned off. A performance cannot be restored once it's been deleted.
Depressing a pedal has no effect, or the pedal effect doesn't stop	Is the pedal connected correctly? Make sure the pedal cord extending from the stand is securely connected to the pedal jack on the rear of the unit (p. 10).
The pedal rattles	Adjust the adjuster underneath the pedal so that the pedal presses firmly against the floor surface (p. 12).
Reverberation still audible even with Reverb turned off	Since the HP-7/3's piano sounds faithfully reproduce the sense of spaciousness and reverberation of an actual acoustic piano's sound, a certain amount of reverberation is still perceptible, even with the reverb effect deactivated.

Appendices

Case	Cause/Remedy	Case	Cause/Remedy
In the upper range, the sound changes abruptly beyond a certain key	On an acoustic piano, notes in the upper one and a half octaves of the keyboard continue to sound until they decay naturally, regardless of the damper pedal. There is a difference in the timbre as well. Roland pianos faithfully simulate such characteristics of the acoustic piano. On the HP-7/3, the range that is unaffected by the damper pedal will change depending on the Key Transpose setting.		
A High-pitched whine is produced	When listening through headphones: Some of the more flamboyant and effervescent piano tones feature an ample high-end component, which may make the sound appear to have metallic reverberation added. Since this reverberation becomes particularly audible when supplemented by heavy reverb, you may be able to diminish the problem by reducing the amount of reverb applied to the sound. When listening through speakers: Here, a different cause (such as resonance produced by the HP-7/3) would be suspect. Consult your Roland dealer or nearest Roland Service Center.	The bass range sounds odd, or there is a vibrating resonance	When listening through speakers: Playing at loud volumes may cause instruments near the HP-7/3 to resonate. Resonance can also occur with fluorescent light tubes, glass doors, and other objects. In particular, this problem occurs more easily when the bass component is increased, and when the sound is played at higher volumes. Use the following measures to suppress such resonance. <ul style="list-style-type: none"> • Place speakers so they are 10–15 cm from walls and other surfaces. • Reduce the volume. • Move the speakers away from any resonating objects. When listening through headphones: Here, a different cause (such as resonance produced by the HP-7/3) would be suspect. Consult your Roland dealer or nearest Roland Service Center.
		The volume level of the instrument connected to Input jacks is too low	Could you be using a connection cable that contains a resistor? Use a connection cable that does not contain a resistor.

Error Messages/Other Messages

Display	Meaning
USr	User. Stores recorded performances (p. 28).
U.sr.	The "." in the display indicates that there is performance material already recorded (p. 28).
d.	Built-in song number (p. 13).
r.	Rhythm number (p. 20).
PU	This appears when a song with a pickup (a song that does not start on the first beat) is played back.
dEL	This appears when you attempt to delete a recorded song (p. 27, p. 32).
E.32	The amount of performance information is too large, and further recording is not possible.
E.41	A problem such as a loose MIDI cable occurred. Make sure the MIDI cables are correctly hooked up.

* Error messages are indicated by an "E." before the number. Press any button, and you can cancel the error message.

Tone List

		[Split] Off	[Split] On		
Button name	[Variation]	Tone	[Variation] Dark	[Variation] Red	[Variation] Green
[Piano]	Dark	Grand Piano1	Grand Piano1 /Acoustic Bass *	Grand Piano1 /Acoustic Bass & Cymbal *	Grand Piano1 /Strings
	Red	Grand Piano2	Grand Piano2 /Acoustic Bass *	Grand Piano2 /Acoustic Bass & Cymbal *	Grand Piano2 /Strings
	Green	Piano + Strings			
	Orange	Piano + Choir			
[E. Piano]	Dark	Electric Piano1	Electric Piano1 /Electric Bass *	Electric Piano1 /Acoustic Bass *	Electric Piano1 /Strings
	Red	Electric Piano2	Electric Piano2 /Electric Bass *	Electric Piano2 /Acoustic Bass *	Electric Piano2 /Strings
	Green	Vibraphone			
	Orange	Electric Piano+Choir			
[Harpsi- chord]	Dark	Harpsichord	Harpsichord /Strings	Harpsichord /Organ Flute	Harpsichord /Acoustic Bass *
	Red	Organ Flute	Organ Flute /Organ Bass	Organ Flute /Strings	Organ Flute /Choir
	Green	Harpsichord + Strings			
	Orange	Harpsichord + Choir			
[Organ]	Dark	Church Organ	Church Organ /Organ Bass	Church Organ /Strings	Church Organ /Choir
	Red	Rotary Organ	Rotary Organ /Lower Organ	Rotary Organ /Electric Bass *	Jazz Organ /Rotary Organ
	Green	Organ + Strings			
	Orange	Organ + Choir			
[Strings]	Dark	Strings	Strings /Pizzicato	Strings /Choir	Oboe /Strings
	Red	Slow Strings	Slow Strings /Pizzicato	Slow Strings /Choir	Flute /Slow Strings
	Green	Strings + Choir			
	Orange	Strings + Brass			
[Voice] (HP-7 only)	Dark	Jazz Scat	Jazz Scat /Voice Bass	Jazz Scat /Acoustic Bass *	Jazz Scat /Choir
	Red	Choir	Choir /Strings	Choir /Church Organ	Choir /Organ Flute
	Green	Choir + Harp			
	Orange	Choir + Bell			

* A+B: simultaneously playing two tones
A/B: A, the right-hand tone; and B, the left-hand tone in Split performance

* * indicates a tone that will not be applied the chorus effect (p. 21).

Built-in Song List

Song No.	Song Name	Composer	Copyright
d. 1	1ère Arabesque	C. Debussy	© 1995 Roland Corporation
d. 2	Late Night Chopin	F. Chopin/ Arranged by John Maul	© 2002 Roland Corporation
d. 3	Sonate für Klavier No. 15	W. A. Mozart	© 1996 Roland Corporation
d. 4	Fly Free	J. Maul	© 1998 Roland Corporation
d. 5	Liebesträume III	F. Liszt	© 2001 Roland Corporation
d. 6	Étude, op.10-3	F. Chopin	© 2001 Roland Corporation
d. 7	Je te veux	E. Satie	© 1997 Roland Corporation
d. 8	Valse, op.64-1	F. Chopin	© 2001 Roland Corporation
d. 9	Golliwog's Cake walk	C. Debussy	© 1995 Roland Corporation
d. 10	Fantaisie-Impromptu	F. Chopin	© 2001 Roland Corporation
d. 11	An der schönen, blauen Donau	J. Strauss	© 1996 Roland Corporation
d. 12	Auf Flügeln des Gesanges	F. Mendelsshon	© 1996 Roland Corporation
d. 13	Mazurka No.5	F. Chopin	© 1995 Roland Corporation
d. 14	1ère Gymnopédie	E. Satie	© 1997 Roland Corporation
d. 15	Étude, op.25-1	F. Chopin	© 1995 Roland Corporation
d. 16	Clair de Lune	C. Debussy	© 1998 Roland Corporation
d. 17	Étude, op.10-5	F. Chopin	© 2001 Roland Corporation
d. 18	Doctor Gradus ad Parnassum	C. Debussy	© 1995 Roland Corporation
d. 19	Grande Valse Brillante	F. Chopin	© 1995 Roland Corporation
d. 20	La prière d'une Vierge	T. Badarzewska	© 1996 Roland Corporation
d. 21	Course en Troïka	P. Tchaikovsky	© 1996 Roland Corporation
d. 22	To The Spring	E. Grieg	© 1996 Roland Corporation
d. 23	Valse, op.64-2	F. Chopin	© 1996 Roland Corporation
d. 24	Radetzky Marsch	J. Strauss	© 1996 Roland Corporation
d. 25	Träumerei	R. Schumann	© 1996 Roland Corporation
d. 26	Moments Musicaux III	F. Schubert	© 1996 Roland Corporation
d. 27	Prélude, op.28-15	F. Chopin	© 1996 Roland Corporation
d. 28	The harmonious blacksmith	G. Handel	© 1996 Roland Corporation
d. 29	Ungarische Tänze V	J. Brahms	© 1996 Roland Corporation
d. 30	Türkischer Marsch (Beethoven)	L. v. Beethoven	© 1996 Roland Corporation
d. 31	Nocturne No.2	F. Chopin	© 1996 Roland Corporation
d. 32	Frühlingslied	F. Mendelsshon	© 1996 Roland Corporation
d. 33	Präludium	J. S. Bach	© 1996 Roland Corporation
d. 34	Jägerlied	F. Mendelsshon	© 1996 Roland Corporation
d. 35	Menuet Antique	M. Ravel	© 1996 Roland Corporation
d. 36	Für Elise	L. v. Beethoven	© 1996 Roland Corporation
d. 37	Türkischer Marsch (Mozart)	W. A. Mozart	© 1996 Roland Corporation
d. 38	Ständchen	F. Schubert	© 1996 Roland Corporation
d. 39	Humoreske	A. Dvorjak	© 1996 Roland Corporation
d. 40	Blumenlied	G. Lange	© 1996 Roland Corporation
d. 41	Alpenglöckchen	T. Oesten	© 1996 Roland Corporation
d. 42	Menuett G dur (Beethoven)	L. v. Beethoven	© 1996 Roland Corporation
d. 43	Venezianisches Gondellied	F. Mendelsshon	© 1996 Roland Corporation
d. 44	Alpenabendröte	T. Oesten	© 1996 Roland Corporation

Song No.	Song Name	Composer	Copyright
d. 45	Farewell to the Piano	L. v. Beethoven	© 1996 Roland Corporation
d. 46	Brautchor	W. Wagner	© 1996 Roland Corporation
d. 47	Battle of Waterloo	W. Anderson	© 1996 Roland Corporation
d. 48	Wiener Marsch	C. Czerny	© 1996 Roland Corporation
d. 49	Le Coucou	L. C. Daquin	© 1996 Roland Corporation
d. 50	Menuett G dur (Bach)	J. S. Bach	© 1992 Roland Corporation
d. 51	Spinnerlied	A. Ellmenreich	© 1996 Roland Corporation
d. 52	Gavotte	F. Gossec	© 1996 Roland Corporation
d. 53	Heidenröslein	G. Lange	© 1996 Roland Corporation
d. 54	Zigeuner Tanz	H. Lichner	© 1996 Roland Corporation
d. 55	La Cinquantaine	G. Marie	© 1996 Roland Corporation
d. 56	Csikos Post	H. Necke	© 1996 Roland Corporation
d. 57	Dolly's Dreaming Awakening	T. Oesten	© 1996 Roland Corporation
d. 58	La Violette	L. Streabbog	© 1996 Roland Corporation
d. 59	Fröhlicher Landmann	R. Schumann	© 1996 Roland Corporation
d. 60	Sonatine op.36-1 (Clementi)	M. Clementi	© 1996 Roland Corporation
d. 61	Sonatine op.20-1 (Kuhlau)	F. Kuhlau	© 1996 Roland Corporation
d. 62	Sonatine No.5 (Beethoven)	L. v. Beethoven	© 1996 Roland Corporation
d. 63	Hungarian Rag: Hungarian Dance No. 5 Ragtime Arrangement For Solo Piano	J. Brahms/ Arranged by John Maul	© 1996 Roland Corporation
d. 64	Paganooogie Variation: Jazz Variation Based on "Caprice No. 24 in A Minor"	N. Paganini/ Arranged by John Maul	© 1998 Roland Corporation
d. 65	L'éveil del l'amour	Masashi & Kazuko Hirashita	© 2000 Roland Corporation

* All rights reserved. Unauthorized use of this material for purposes other than private, personal enjoyment is a violation of applicable laws.

Rhythm List

Beat	Rhythm No.	Rhythm Name
2/2	r. 1	2/2 March
	r. 2	2/2 Swing
	r. 3	2/2 Voice (Japanese)
	r. 4	2/2 Voice (English)
	r. 5	2/2 Animal
0/4	r. 1	Stick
2/4	r. 1	2/4 March
	r. 2	2/4 Country
	r. 3	Samba
	r. 4	2/4 Voice (Japanese)
	r. 5	2/4 Voice (English)
	r. 6	2/4 Animal
3/4	r. 1	Waltz
	r. 2	Country Waltz
	r. 3	3/4 Gospel
	r. 4	Waltz2
	r. 5	Jazz Waltz
	r. 6	3/4 Voice (Japanese)
	r. 7	3/4 Voice (English)
	r. 8	3/4 Animal

Beat	Rhythm No.	Rhythm Name
4/4	r. 1	16-beat 1
	r. 2	8-beat 1
	r. 3	8-beat 2
	r. 4	8-beat 3
	r. 5	16-beat 2
	r. 6	16-beat 3
	r. 7	Rock
	r. 8	Rock2
	r. 9	4/4 Swing
	r. 10	4/4 Shuffle
	r. 11	4/4 Triplet
	r. 12	Tango
	r. 13	Mambo
	r. 14	House
	r. 15	Bossa Nova
	r. 16	4/4 Voice (Japanese)
	r. 17	4/4 Voice (English)
	r. 18	4/4 Animal
5/4	r. 1	5/4
6/4	r. 1	6/4
7/4	r. 1	7/4
3/8	r. 1	3/8
	r. 2	3/8 Voice (Japanese)
	r. 3	3/8 Voice (English)
	r. 4	3/8 Animal
6/8	r. 1	6/8 Ballad
	r. 2	6/8 March
	r. 3	6/8 Swing
	r. 4	6/8 Voice (Japanese)
	r. 5	6/8 Voice (English)
	r. 6	6/8 Animal
9/8	r. 1	9/8
12/8	r. 1	12/8

Easy Operation List

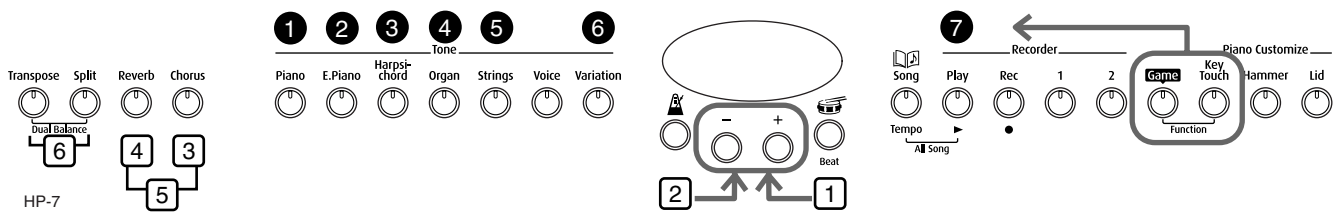

No.	You want to	Buttons	Page
Press the [Game] and [Key Touch] buttons simultaneously, and press the [●] button.			
①	Master Tuning	[Game] + [Key Touch] → [Piano]	p. 34
②	Selecting a temperament Specifying the keynote	[Game] + [Key Touch] → [E. Piano] → [E. Piano] + key	p. 34
③	Stretch tuning	[Game] + [Key Touch] → [Harpichord]	p. 35
④	Applying the damper pedal to the left-hand keyboard area	[Game] + [Key Touch] → [Organ]	p. 35
⑤	MIDI send channel settings	[Game] + [Key Touch] → [Strings]	p. 38
⑥	Local Control	[Game] + [Key Touch] → [Variation]	p. 38
⑦	Transmitting a recorded performance	[Game] + [Key Touch] → [▶ (Play)]	p. 38
Hold down the [□] button and press the [-] or [+] button.			
①	Beat of metronome/rhythm	[🎵 (Rhythm)/Beat] + [-] [+]	p. 19 p. 20
②	Metronome/rhythm volume	[🎵 (Metronome)] + [-] [+]	p. 19
③	Depth of the Chorus effect	[Chorus] + [-] [+]	p. 21
④	Depth of the Reverb effect	[Reverb] + [-] [+]	p. 21
⑤	Damper pedal's resonance level	[Reverb] + [Chorus] + [-] [+]	p. 33
Press the [□] button, and press the [-] or [+] button.			
⑥	Dual Balance	[Transpose] + [Split] → [-][+]	p. 16
Hold down the [Split] or [Transpose] button and press the key.			
	Split Point	[Split] + key	p. 18
	Key Transpose	[Transpose] + key	p. 22

Appendices

DIGITAL PIANO

Date : Dec. 1, 2001

Model HP-7/3

MIDI Implementation Chart

Version : 1.00

Function...	Transmitted	Recognized	Remarks
Basic Channel Default Changed	1 1-16	1 1-16	
Mode Default Messages Altered	Mode 3 x *****	Mode 3 x	
Note Number : True Voice	15-113 *****	0-127 15-113	
Velocity Note ON Note OFF	O x 8n v=64	O x	
After Touch Key's Ch's	x x	x x	
Pitch Bend	x	x	
Control Change 6, 38 7 11 64 66 67 91 93 100, 101	O x x O O O O O O O	O O O O O O O O O	Data entry Volume Expression Hold 1 Sostenuto Soft Effect 1 (Reverb) Effect 3 (Chorus) RPN LSB, MSB
Prog Change : True Number	O (*1) *****	O (0-127) 0...119	
System Exclusive	O	O	
System Common : Song Pos : Song Sel : Tune	x x x	x x x	
System Real Time : Clock : Commands	x x	x x	
Aux Message : All sound off : Reset all controllers : Local Control : All Notes OFF : Active Sense : Reset	x x x x O x	x O O O (123-127) O x	
Notes	*1 0...119 (HP-7), 0...117 (HP-3)		

Mode 1 : OMNI ON, POLY

Mode 2 : OMNI ON, MONO

O : Yes

Mode 3 : OMNI OFF, POLY

Mode 4 : OMNI OFF, MONO

X : No

Main Specifications

Keyboard	
Keyboard	88 keys Progressive Hammer Action Keyboard (HP-3)
	88 keys Progressive Hammer Action Keyboard with Escapement (HP-7)
Touch Sensitivity	Preset 4 Levels
Keyboard Mode	Whole, Dual (adjustable dual balance), Split (adjustable split point)
Sound Generator	
Max. Polyphony	64 voices
Tones	6 groups 24 variations (HP-7)
	5 groups 20 variations (HP-3)
Temperament	7 types, selectable tonic
Stretched Tuning	2 types
Master Tuning	415.3 Hz–466.2 Hz (0.1 Hz Step)
Transpose	Key Transpose (-6–+5 Half-steps)
Effects	Reverb (8 levels), Chorus (8 levels), Sympathetic Resonance (for Piano only, 8 levels)
Metronome & Rhythm	
Beat	2/2, 0/4, 2/4, 3/4, 4/4, 5/4, 6/4, 7/4, 3/8, 6/8, 9/8, 12/8
Volume	8 levels
Rhythm Patterns	53 Patterns
Recorder	
Tracks	2 tracks
Song	1 song
Note Storage	Approx. 5,000 notes
Tempo	Quarter note = 20–250
Resolution	96 ticks per quarter note
Control	Play/Stop, Rec, Tempo, All Song Play, Track Select
Preset Songs	65 songs
Others	
Rated Power Output	40 W x 2 (HP-7)
	25 W x 2 (HP-3)
Speakers	16 cm x 2 (with speaker box), 5 cm x 2 (HP-7)
	16 cm x 2 (HP-3)
Display	7-segment, 3-digit LED
Control	Volume, Brilliance
Pedals	Damper (half-pedal recognition: HP-7), Soft (half-pedal recognition: HP-7), Sostenuto
Other Functions	Panel Lock, Game, Lid (HP-7), Hammer Response (HP-7)
Connectors	Output jacks (L/Mono, R), Input jacks (L/Mono, R), Headphone jack x 2 (Stereo), MIDI In/MIDI Out connectors, Pedal connector
Power supply	AC 117 V / AC 230 V / AC 240 V
Power Consumption	80 W (HP-7)
	45 W (HP-3)
Dimensions (including piano stand)	1,445 (W) x 524 (D) x 872 (H) mm / 56-15/16 (W) x 20-11/16 (D) x 34-3/8 (H) inches (HP-7/3)
	1,445 (W) x 524 (D) x 1,085 (H) mm / 56-15/16 (W) x 20-11/16 (D) x 42-3/4 (H) inches (including music stand: HP-7)
	1,445 (W) x 524 (D) x 1,083 (H) mm / 56-15/16 (W) x 20-11/16 (D) x 42-11/16 (H) inches (including music stand: HP-3)
Weights (including Piano Stand)	75.0 kg / 165 lbs 6 oz (HP-7)
	66.0 kg / 145 lbs 9 oz (HP-3)
Accessories	Owner's manual, AC cord, Roland 60 Classical Piano Masterpieces

* In the interest of product improvement, the specifications and/or appearance of this unit are subject to change without prior notice.

Index

A

AC inlet	10
Adjuster	12
All Song Play	13
Audio equipment	36

B

Beat	18, 20
[Brilliance] knob	12
Built-in song	13

C

Chorus	21
Depth	21
Computer	36
Count-In	25

D

Damper pedal	
Resonance	33
Damper pedal	12, 35
Dual balance	16
Dual performance	16

E

Effects	21
Amount of effect applied	21
Erase	32

F

Function	33
----------------	----

G

Game	14
------------	----

H

Hammer Response (HP-7)	24
Headphones	11

K

Key Touch	23
-----------------	----

L

Lid	11
Lid (HP-7)	24
Local Control	38

M

Master Tuning	34
Metronome	18
MIDI	37
MIDI channel	38
MIDI devices	37
Music holder	11
Music stand	10

P

Panel Lock	35
Pedal	12
Pedal cable	10
Pedal connector	10
Phones jack	11
Piano Customize (HP-7)	24
Play	
All songs continuously	13
Along with the built-in songs	25
Each hand	26
Selecting a song	13
Power	12
Power cord	10
[Power] switch	12

R

Record	27
Along with a song	30
Along with the rhythm	29
Each Hand	31
Erasing performances	32
New Song	28
Reverb	21
Depth	21
Rhythm	20

S

Soft pedal	12
Sostenuto pedal	12
Speaker cable	10
Split performance	17
Split Point	18
Stretch Tuning	35
Sympathetic Resonance	12

T

Temperament	34
Tempo	18, 20, 25
Tone	15
Tone button	15
Tone group	15
Track button	26, 31
Transpose	22
[Transpose] button	22
Tuning Curve	35

V

Variation tone	15
Volume	
Metronome/Rhythm	19
[Volume] knob	12

MEMO

Information

When you need repair service, call your nearest Roland Service Center or authorized Roland distributor in your country as shown below.

AFRICA

EGYPT

Al Fanny Trading Office
9, EBN Hagar A1 Askalany Street,
ARD El Golf, Heliopolis,
Cairo 11341, EGYPT
TEL: 20-2-417-1828

REUNION

Maison FO - YAM Marcel
25 Rue Jules Hermann,
Chaudron - BP79 97 491
Ste Clotilde Cedex,
REUNION ISLAND
TEL: (0262) 218-429

SOUTH AFRICA

**That Other Music Shop
(PTY) Ltd.**
11 Melle St., Braamfontein,
Johannesburg, SOUTH AFRICA
P.O.Box 32918, Braamfontein 2017
Johannesburg, SOUTH AFRICA
TEL: (011) 403 4105

Paul Bothner (PTY) Ltd.
17 Werdmuller Centre,
Main Road, Claremont 7708
SOUTH AFRICA

P.O.BOX 23032, Claremont 7735,
SOUTH AFRICA
TEL: (021) 674 4030

ASIA

CHINA

**Roland Shanghai Electronics
Co.,Ltd.**
5F, No.1500 Pingliang Road
Shanghai 200090, CHINA
TEL: (021) 5580-0800

**Roland Shanghai Electronics
Co.,Ltd.
(BEIJING OFFICE)**
10F, No.18 Anhuaxili
Chaoyang District, Beijing 100011
CHINA
TEL: (010) 6426-5050

**Roland Shanghai Electronics
Co.,Ltd.
(GUANGZHOU OFFICE)**
2/F., No.30 Si You Nan Er Jie Yi
Xiang, Wu Yang Xin Cheng,
Guangzhou 510600, CHINA
TEL: (020) 8736-0428

HONG KONG

**Tom Lee Music Co., Ltd.
Service Division**
22-32 Pun Shan Street, Tsuen
Wan, New Territories,
HONG KONG
TEL: 2415 0911

Parsons Music Ltd.
8th Floor, Railway Plaza, 39
Chatham Road South, T.S.T,
Kowloon, HONG KONG
TEL: 2333 1863

INDIA

Rivera Digitec (India) Pvt. Ltd.
409, Nirman Kendra Mahalaxmi
Flats Compound Off. Dr. Edwin
Moses Road, Mumbai-400011,
INDIA
TEL: (022) 2493 9051

INDONESIA

PT Citra IntiRama
Jl. Cideng Timur No. 15j-150
Jakarta Pusat
INDONESIA
TEL: (021) 6324170

KOREA

Cosmos Corporation
1461-9, Seocho-Dong,
Seocho Ku, Seoul, KOREA
TEL: (02) 3486-8855

MALAYSIA

BENTLEY MUSIC SDN BHD
140 & 142, Jalan Bukit Bintang
55100 Kuala Lumpur, MALAYSIA
TEL: (03) 2144-3333

PHILIPPINES

G.A. Yupangco & Co. Inc.
339 Gil J. Puyat Avenue
Makati, Metro Manila 1200,
PHILIPPINES
TEL: (02) 899 9801

SINGAPORE

Swee Lee Company
150 Sims Drive,
SINGAPORE 387381
TEL: 6846-3676

**CRISTOFORI MUSIC PTE
LTD**
Blk 3014, Bedok Industrial Park E,
#02-2148, SINGAPORE 489980
TEL: 6243-9555

TAIWAN

**ROLAND TAIWAN
ENTERPRISE CO., LTD.**
Room 5, 9fl. No. 112 Chung Shan
N.Road Sec.2, Taipei, TAIWAN,
R.O.C.
TEL: (02) 2561 3339

THAILAND

Theera Music Co., Ltd.
330 Veng NakornKasem, Soi 2,
Bangkok 10100, THAILAND
TEL: (02) 2248821

VIETNAM

Saigon Music
Suite DP-8
40 Ba Huyen Thanh Quan Street
Hochiminh City, VIETNAM
Tel: (08) 930-1969

AUSTRALIA/ NEW ZEALAND

AUSTRALIA

**Roland Corporation
Australia Pty., Ltd.**
38 Campbell Avenue
Dee Why West. NSW 2099
AUSTRALIA
TEL: (02) 9982 8266

NEW ZEALAND

Roland Corporation Ltd.
32 Shaddock Street, Mount Eden,
Auckland, NEW ZEALAND
TEL: (09) 3098 715

CENTRAL/LATIN AMERICA

ARGENTINA

Instrumentos Musicales S.A.
Av.Santa Fe 2055
(1123) Buenos Aires
ARGENTINA
TEL: (011) 4508-2700

BRAZIL

Roland Brasil Ltda
Rua San Jose, 780 Sala B
Parque Industrial San Jose
Co'ia - Sao Paulo - SP, BRAZIL
TEL: (011) 4615 5666

COSTA RICA

**JUAN BANSBACH
Instrumentos Musicales**
Ave.1. Calle 11, Apartado 10237,
San Jose, COSTA RICA
TEL: 258-0211

CHILE

Comercial Fancy II S.A.
Rut.: 96.919.420-1
Nataliel Cox #739, 4th Floor
Santiago - Centro, CHILE
TEL: (02) 688-9540

EL SALVADOR

OMNI MUSIC
75 Avenida Norte y Final
Alameda Juan Pablo II,
Edificio No.4010 San Salvador,
EL SALVADOR
TEL: 262-0788

MEXICO

Casa Veerkamp, s.a. de c.v.
Av. Toluca No. 323, Col. Olivar
de los Padres 01780 Mexico D.F.
MEXICO
TEL: (55) 5668-6699

PANAMA

SUPRO MUNDIAL, S.A.
Boulevard Andrews, Albrook,
Panama City, REP. DE PANAMA
TEL: 315-0101

PARAGUAY

**Distribuidora De
Instrumentos Musicales**
J.E. Olear y ESQ. Manduvira
Asuncion PARAGUAY
TEL: (021) 492-124

URUGUAY

Todo Musica S.A.
Francisco Acuna de Figueroa 1771
C.P.: 11.800
Montevideo, URUGUAY
TEL: (02) 924-2335

VENEZUELA

Musicland Digital C.A.
Av. Francisco de Miranda,
Centro Parque de Cristal, Nivel
C2 Local 20 Caracas
VENEZUELA
TEL: (212) 285-8586

EUROPE

AUSTRIA

Roland Austria GES.M.B.H.
Siemensstrasse 4, P.O. Box 74,
A-6063 RUM, AUSTRIA
TEL: (0512) 26 44 260

BELGIUM/HOLLAND/ LUXEMBOURG

Roland Benelux N. V.
Houtstraat 3, B-2260, Oevel
(Westerlo) BELGIUM
TEL: (014) 575811

CZECH REP.

K-AUDIO
Kardasovska 626.
CZ-198 00 Praha 9,
CZECH REP.
TEL: (2) 666 10529

DENMARK

Roland Scandinavia A/S
Nordhavnsvej 7, Postbox 880,
DK-2100 Copenhagen
DENMARK
TEL: 3916 6200

FRANCE

Roland France SA
4, Rue Paul Henri SPAAK,
Parc de l'Esplanade, F 77 462 St.
Thibault, Lagny Cedex FRANCE
TEL: 01 600 73 500

FINLAND

**Roland Scandinavia As,
Filial Finland**
Elannontie 5
FIN-01510 Vantaa, FINLAND
TEL: (09) 68 24 020

GERMANY

**Roland Elektronische
Musikinstrumente HmbH.**
Oststrasse 96, 22844 Norderstedt,
GERMANY
TEL: (040) 52 60090

GREECE

STOLLAS S.A.
Music Sound Light
155, New National Road
Patras 26442, GREECE
TEL: 2610 435400

HUNGARY

Roland East Europe Ltd.
Warehouse Area DEPO Pf.83
H-2046 Torokbalint, HUNGARY
TEL: (23) 511011

IRELAND

Roland Ireland
G2 Calmount Park, Calmount
Avenue, Dublin 12
Republic of IRELAND
TEL: (01) 4294444

ITALY

Roland Italy S. p. A.
Viale delle Industrie 8,
20020 Arese, Milano, ITALY
TEL: (02) 937-78300

NORWAY

**Roland Scandinavia Avd.
Kontor Norge**
Lilleakerveien 2 Postboks 95
Lilleaker N-0216 Oslo
NORWAY
TEL: 2273 0074

POLAND

POL MUSIC SP.Z.O.O.
UL. Gibraltarska 4.
PL-03664 Warszawa POLAND
TEL: (022) 679 44 19

PORTUGAL

**Tecnologias Musica e Audio,
Roland Portugal, S.A.**
Cais Das Pedras, 8/9-1 Dto
4050-465 PORTO
PORTUGAL
TEL: (022) 608 00 60

ROMANIA

FBS LINES
Piata Libertatii 1,
535500 Gheorgheni, ROMANIA
TEL: (266) 364 609

RUSSIA

MuTek
3-Bogatyrskaya Str. 1.k.1
107 564 Moscow, RUSSIA
TEL: (095) 169 5043

SPAIN

**Roland Electronics
de Espa a, S. A.**
Calle Bolivia 239, 08020
Barcelona, SPAIN
TEL: (93) 308 1000

SWEDEN

**Roland Scandinavia A/S
SWEDISH SALES OFFICE**
Danvik Center 28, 2 tr.
S-131 30 Nacka SWEDEN
TEL: (08) 702 00 20

SWITZERLAND

Roland (Switzerland) AG
Landstrasse 5, Postfach,
CH-4452 Itingen,
SWITZERLAND
TEL: (061) 927-8383

UKRAINE

TIC-TAC
Mira Str. 19/108
P.O. Box 180
295400 Munkachevo, UKRAINE
TEL: (03131) 414-40

UNITED KINGDOM

Roland (U.K.) Ltd.
Atlantic Close, Swansea
Enterprise Park, SWANSEA
SA7 9FJ,
UNITED KINGDOM
TEL: (01792) 702701

MIDDLE EAST

BAHRAIN

Moon Stores
No.16, Bab Al Bahrain Avenue,
P.O.Box 247, Manama 304,
State of BAHRAIN
TEL: 211 005

CYPRUS

Radex Sound Equipment Ltd.
17, Diaporou Street, Nicosia,
CYPRUS
TEL: (022) 66-9426

IRAN

MOCO, INC.
No.41 Nike St., Dr.Shariyati Ave.,
Roberoye Cerahe Mirdamad
Tehran, IRAN
TEL: (021) 285-4169

ISRAEL

**Halilit P. Greenspoon &
Sons Ltd.**
8 Retzif Ha'aluya Hashnya St.
Tel-Aviv-Yafo ISRAEL
TEL: (03) 6823666

JORDAN

AMMAN Trading Agency
245 Prince Mohammad St.,
Amman 1118, JORDAN
TEL: (06) 464-1200

KUWAIT

Easa Husain Al Yousifi Est.
Abdullah Salem Street,
Safat, KUWAIT
TEL: 243-6399

LEBANON

Chahine S.A.L.
Gerge Zeidan St, Chahine Bldg.,
Achrafieh, P.O.Box: 16-5857
Beirut, LEBANON
TEL: (01) 20-1441

QATAR

**Al Emadi Co. (Badie Studio
& Stores)**
P.O. Box 62, Doha, QATAR
TEL: 4423-554

SAUDI ARABIA

**aDawlah Universal
Electronics APL**
Corniche Road, Aldossary Bldg.,
1st Floor, Alkhobar,
SAUDI ARABIA

P.O.Box 2154, Alkhobar 31952
SAUDI ARABIA
TEL: (03) 898 2081

SYRIA

**Technical Light & Sound
Center**
Khaled Ebn Al Walid St.
Bldg. No. 47, P.O.BOX 13520,
Damascus, SYRIA
TEL: (011) 223-5384

TURKEY

**Ant Muzik Aletleri Ithalat
Ve Ihracat Ltd Sti**
Sirasesviler Caddesi Sirasesviler
Pasaji No:74/20
Taksim - Istanbul, TURKEY
TEL: (0212) 2499324

U.A.E.

**Zak Electronics & Musical
Instruments Co. L.L.C.**
Zabeel Road, Al Sherooq Bldg.,
No. 14, Grand Floor, Dubai, U.A.E.
TEL: (04) 3360715

NORTH AMERICA

CANADA

**Roland Canada Music Ltd.
(Head Office)**
5480 Parkwood Way Richmond
B. C., V6V 2M4 CANADA
TEL: (604) 270 6626

Roland Canada Music Ltd. (Toronto Office)

170 Admiral Boulevard
Mississauga On L5T 2N6
CANADA
TEL: (905) 362 9707

U. S. A.

Roland Corporation U.S.
5100 S. Eastern Avenue
Los Angeles, CA 90040-2938,
U. S. A.
TEL: (323) 890 3700

For EU Countries



This product complies with the requirements of European Directives EMC 89/336/EEC and LVD 73/23/EEC.

For the USA

FEDERAL COMMUNICATIONS COMMISSION RADIO FREQUENCY INTERFERENCE STATEMENT

This equipment has been tested and found to comply with the limits for a Class B digital device, pursuant to Part 15 of the FCC Rules. These limits are designed to provide reasonable protection against harmful interference in a residential installation. This equipment generates, uses, and can radiate radio frequency energy and, if not installed and used in accordance with the instructions, may cause harmful interference to radio communications. However, there is no guarantee that interference will not occur in a particular installation. If this equipment does cause harmful interference to radio or television reception, which can be determined by turning the equipment off and on, the user is encouraged to try to correct the interference by one or more of the following measures:

- Reorient or relocate the receiving antenna.
- Increase the separation between the equipment and receiver.
- Connect the equipment into an outlet on a circuit different from that to which the receiver is connected.
- Consult the dealer or an experienced radio/TV technician for help.

This device complies with Part 15 of the FCC Rules. Operation is subject to the following two conditions:

- (1) This device may not cause harmful interference, and
- (2) This device must accept any interference received, including interference that may cause undesired operation.

Unauthorized changes or modification to this system can void the users authority to operate this equipment.
This equipment requires shielded interface cables in order to meet FCC class B Limit.

For Canada

NOTICE

This Class B digital apparatus meets all requirements of the Canadian Interference-Causing Equipment Regulations.

AVIS

Cet appareil numérique de la classe B respecte toutes les exigences du Règlement sur le matériel brouilleur du Canada.

Contents		
No.	Name	Qty.
1	Instrument	1
2	Music Stand (HP-3 only)	1
3	Manual Set	1
4	AC Cord Set	1
5	Collection of Printed Music	1

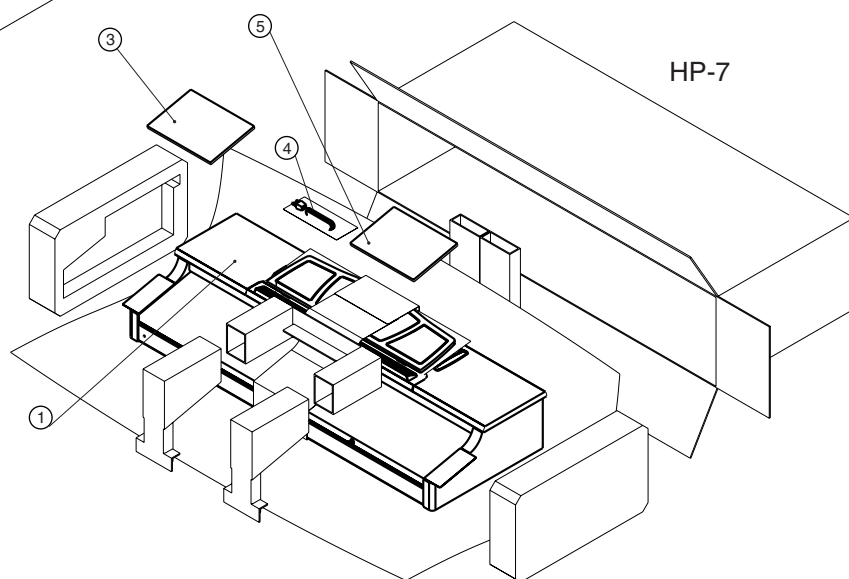
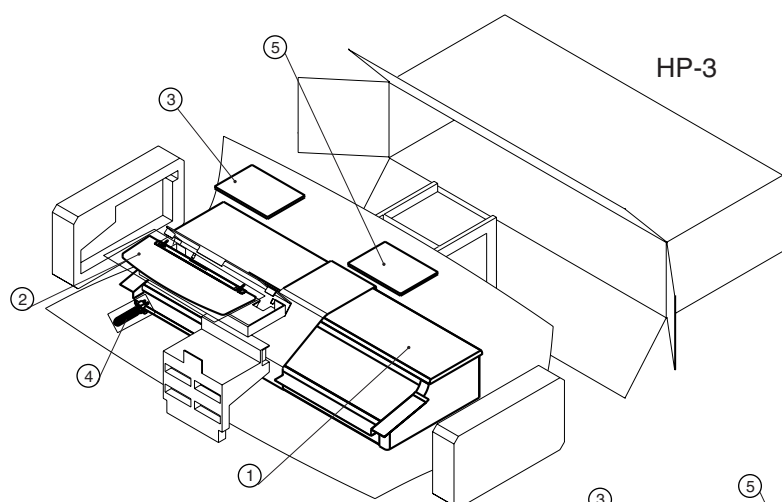

This owner's manual is printed on recycled paper.

Free Manuals Download Website

<http://myh66.com>

<http://usermanuals.us>

<http://www.somanuals.com>

<http://www.4manuals.cc>

<http://www.manual-lib.com>

<http://www.404manual.com>

<http://www.luxmanual.com>

<http://aubethermostatmanual.com>

Golf course search by state

<http://golfingnear.com>

Email search by domain

<http://emailbydomain.com>

Auto manuals search

<http://auto.somanuals.com>

TV manuals search

<http://tv.somanuals.com>