



Before using this unit, carefully read the sections entitled: "IMPORTANT SAFETY INSTRUCTIONS" (p. 3 HP305 only), "USING THE UNIT SAFELY" (p. 8), and "IMPORTANT NOTES" (p. 11). These sections provide important information concerning the proper operation of the unit. Additionally, in order to feel assured that you have gained a good grasp of every feature provided by your new unit, Owner's manual should be read in its entirety. The manual should be saved and kept on hand as a convenient reference.

**WARNING:** To reduce the risk of fire or electric shock, do not expose this apparatus to rain or moisture.

 <b>ATTENTION:</b> RISQUE DE CHOC ELECTRIQUE NE PAS OUVRIR	<b>CAUTION</b> RISK OF ELECTRIC SHOCK DO NOT OPEN	
<b>CAUTION:</b> TO REDUCE THE RISK OF ELECTRIC SHOCK, DO NOT REMOVE COVER (OR BACK). NO USER-SERVICEABLE PARTS INSIDE. REFER SERVICING TO QUALIFIED SERVICE PERSONNEL.		



The lightning flash with arrowhead symbol, within an equilateral triangle, is intended to alert the user to the presence of uninsulated "dangerous voltage" within the product's enclosure that may be of sufficient magnitude to constitute a risk of electric shock to persons.



The exclamation point within an equilateral triangle is intended to alert the user to the presence of important operating and maintenance (servicing) instructions in the literature accompanying the product.

INSTRUCTIONS PERTAINING TO A RISK OF FIRE, ELECTRIC SHOCK, OR INJURY TO PERSONS.

## IMPORTANT SAFETY INSTRUCTIONS SAVE THESE INSTRUCTIONS

**WARNING** - When using electric products, basic precautions should always be followed, including the following:

1. Read these instructions.
2. Keep these instructions.
3. Heed all warnings.
4. Follow all instructions.
5. Do not use this apparatus near water.
6. Clean only with a dry cloth.
7. Do not block any of the ventilation openings. Install in accordance with the manufacturers instructions.
8. Do not install near any heat sources such as radiators, heat registers, stoves, or other apparatus (including amplifiers) that produce heat.
9. Do not defeat the safety purpose of the polarized or grounding-type plug. A polarized plug has two blades with one wider than the other. A grounding type plug has two blades and a third grounding prong. The wide blade or the third prong are provided for your safety. If the provided plug does not fit into your outlet, consult an electrician for replacement of the obsolete outlet.
10. Protect the power cord from being walked on or pinched particularly at plugs, convenience receptacles, and the point where they exit from the apparatus.
11. Only use attachments/accessories specified by the manufacturer.
12. Use only with the cart, stand, tripod, bracket, or table specified by the manufacturer, or sold with the apparatus. When a cart is used, use caution when moving the cart/apparatus combination to avoid injury from tip-over.
13. Unplug this apparatus during lightning storms or when unused for long periods of time.
14. Refer all servicing to qualified service personnel. Servicing is required when the apparatus has been damaged in any way, such as power-supply cord or plug is damaged, liquid has been spilled or objects have fallen into the apparatus, the apparatus has been exposed to rain or moisture, does not operate normally, or has been dropped.



For the U.K.

**IMPORTANT:** THE WIRES IN THIS MAINS LEAD ARE COLOURED IN ACCORDANCE WITH THE FOLLOWING CODE.

BLUE: NEUTRAL  
BROWN: LIVE

As the colours of the wires in the mains lead of this apparatus may not correspond with the coloured markings identifying the terminals in your plug, proceed as follows:

The wire which is coloured BLUE must be connected to the terminal which is marked with the letter N or coloured BLACK.  
The wire which is coloured BROWN must be connected to the terminal which is marked with the letter L or coloured RED.  
Under no circumstances must either of the above wires be connected to the earth terminal of a three pin plug.

Copyright © 2009 ROLAND CORPORATION

All rights reserved. No part of this publication may be reproduced in any form without the written permission of ROLAND CORPORATION.

Roland is registered trademarks or trademarks of Roland Corporation in the United States and/or other countries.



# Lessons at home!

## Play together with your family

Dividing the keyboard for two-person performance (Twin Piano) ••• p. 32



## Check your own performance

Recording your performance ••• p. 43



## Play along with a metronome

Performing with the metronome ••• p. 26

## Select and listen to the song you want to play!

Listening to songs ••• p. 39

Playing back songs on external media ••• p. 64



## Play along with the song one hand at a time

Playing parts individually ••• p. 40

# Now I can play it!

### Night-time or early morning lessons

Using the Headphones ••• p. 23

### Play using different sounds

Performing with various sounds ••• p. 25



## Slow down the tempo for difficult passages

Changing the song's tempo ••• p. 42

# Contents

<b>USING THE UNIT SAFELY .....</b>	<b>8</b>	<b>Listening to Songs .....</b>	<b>39</b>
<b>IMPORTANT NOTES .....</b>	<b>11</b>	Playing Back Songs .....	39
<b>Names of Things and What They Do (HP305) .....</b>	<b>14</b>	Playing Parts Individually.....	40
<b>Names of Things and What They Do (HP302) .....</b>	<b>16</b>	Playing All Songs Consecutively (All Songs Play) ..	41
<b>Before You Play.....</b>	<b>18</b>	Adjusting the Volume of the Song Playback .....	41
Getting Ready to Play .....	18	Changing the Song's Tempo .....	42
Connecting the Pedal Cord (HP305).....	18	Changing the Pitch of the Song (Playback Transpose).....	42
Connecting the Pedal Cord (HP302).....	18	<b>Recording Your Performance .....</b>	<b>43</b>
Connecting the Power Cord (HP305) .....	18	Recording Your Keyboard Performance.....	43
Connecting the AC Adaptor (HP302) .....	18	Erasing Your Recorded Performance.....	45
Setting up the Music Rest (HP305) .....	19	Saving Your Recorded Performance.....	46
Setting up the Music Rest (HP302) .....	20	Deleting a Saved Song .....	48
Opening/Closing the Lid.....	20	Advanced Recording Methods .....	50
Turning the Power On/Off .....	21	Recording Each Hand Separately .....	50
Turning the Power On .....	21	Recording a Performance You Play Along with a Song.....	53
Turning the Power Off .....	21		
Adjusting the Sound's Volume.....	21		
Using the Pedals .....	22		
About the Adjuster .....	22		
Using the Headphones.....	23		
Connecting the Headphones.....	23		
Using the Headphone Hook.....	24		
<b>Performing .....</b>	<b>25</b>		
Performing with Various Sounds.....	25		
Performing with the Metronome .....	26		
Changing the Metronome's Tempo .....	26		
Changing the Metronome's Time Signature .....	27		
Adjusting the Metronome's Volume .....	28		
Adding a Count-in to Synchronize Your Performance (Count-in).....	28		
Adding Reverberation to the Sound (Reverb) .....	29		
Adjusting the Depth of the Reverb Effect..	29		
Adjusting the Keyboard Sensitivity (Key Touch)...	30		
Performing with Two Layered Tones (Dual Play)..	31		
Dividing the Keyboard for Two-person Performance (Twin Piano).....	32		
Changing the Way in Which the Sound is Heard (Twin Piano Mode) .....	33		
Playing Different Tones in the Left and Right Sides of the Keyboard (Split Play) .....	34		
Changing the Tones of the Left and Right Zones.....	35		
Changing the Keyboard's Split Point .....	36		
Transposing the Keyboard (Transpose) .....	37		
Disabling the Buttons (Panel Lock).....	38		



## Various Settings..... 55

Basic Operation in Function Mode .....	55
Sounds Settings .....	57
Adjusting the Sound's Brilliance (Brilliance).....	57
Performing Settings .....	57
Specifying What the Key Transpose will Affect (Transpose Mode).....	57
Changing the Pitch of the Tone in Octave Steps (Octave Shift).....	57
Adjusting the Dual Play Volume Balance (Dual Balance) .....	58
Tuning Settings.....	58
Matching the Pitch with Other Instruments (Master Tuning) .....	58
Using a Piano's Unique Tuning (Stretch Tuning) .....	58
Adjusting the Tuning (Temperament).....	58
Specifying the Temperament Key .....	58
Piano Sound Settings.....	59
Producing Sympathetic Resonance When You Press the Damper Pedal (Damper Resonance).....	59
Producing the Resonance of the Strings When the Keys Are Played (String Resonance) .....	59
Playing Sounds When the Keys Are Released (Key Off Resonance).....	59
Pedal Settings.....	59
Changing How the Pedal Effects Are Applied (Damper Pedal Part) .....	59
Changing How the Pedals Work (Center/Left Pedal Function) .....	59
Other Settings.....	60
Playing Back at a Fixed Tempo (Tempo Mute) .....	60
Changing the Parts Assigned to the Track Buttons During SMF Playback (Track Assign).....	60
Using the Sound of a Specific Part as a "Guide" (Mute Volume).....	60
Setting the Type of CD To be Played Back (CD/Audio Type) .....	60
Storing Your Settings (Memory Backup) .....	61
Restoring the Factory Settings (Factory Reset) .....	61

## Connecting to Other Devices ..... 62

Connecting a Media.....	62
Installing the CD Drive .....	62
Installing the Floppy Disk Drive.....	62
Connecting USB Memory.....	62
Initializing the Memory.....	63
Changing the External Memory Setting (External Memory Mode).....	63
Playing Back Songs on External Media .....	64
Adjusting the Volume of an Audio File or Music CD .....	65
Changing the Tempo of an Audio File or Music CD .....	65
Changing the Playback Pitch of a Song (Playback Transpose).....	65
Minimizing the Sounds in the Center (Center Cancel) .....	65
Switching VIMA TUNES Recommended Tones (Recommended Tone) .....	65
Saving Your Recorded Performance on External Memory .....	66
Deleting a Song from External Memory .....	66
Connecting to Audio Equipment.....	67
Having Audio from an External Device be Sounded Through the HP305/HP302.....	67
Connecting Speakers to the HP305/HP302 and Outputting Sounds.....	68
Connecting to MIDI Devices.....	69
Connecting a MIDI Sequencer to the HP305/ HP302 .....	69
Producing Sounds from a MIDI Sound Module by Playing the HP305/HP302 .....	70
Preventing Doubled Notes When Connected to a Sequencer (Local Control).....	71
MIDI Transmit Channel Settings (MIDI Transmit Channel).....	71
Sending Recorded Performance Data to a MIDI Device (Composer MIDI Out).....	71
Connecting a Computer.....	72
Changing the USB Driver Settings (USB Driver).....	72
Using the V-LINK Function .....	73
Specifying the V-LINK Transmit Channel....	73

## Appendices

Troubleshooting .....	74
Error Messages.....	77
Tone List.....	78
Internal Song List .....	81
Parameters Stored in Memory Backup .....	82
Music Files That the HP305/HP302 Can Use .....	83
MIDI Implementation Chart .....	84
Main Specifications .....	85
Index.....	87



# USING THE UNIT SAFELY

## INSTRUCTIONS FOR THE PREVENTION OF FIRE, ELECTRIC SHOCK, OR INJURY TO PERSONS

### About ⚠ WARNING and ⚠ CAUTION Notices

<b>⚠ WARNING</b>	Used for instructions intended to alert the user to the risk of death or severe injury should the unit be used improperly.
<b>⚠ CAUTION</b>	Used for instructions intended to alert the user to the risk of injury or material damage should the unit be used improperly. * Material damage refers to damage or other adverse effects caused with respect to the home and all its furnishings, as well to domestic animals or pets.

### About the Symbols

	The ⚠ symbol alerts the user to important instructions or warnings. The specific meaning of the symbol is determined by the design contained within the triangle. In the case of the symbol at left, it is used for general cautions, warnings, or alerts to danger.
	The ⓧ symbol alerts the user to items that must never be carried out (are forbidden). The specific thing that must not be done is indicated by the design contained within the circle. In the case of the symbol at left, it means that the unit must never be disassembled.
	The ● symbol alerts the user to things that must be carried out. The specific thing that must be done is indicated by the design contained within the circle. In the case of the symbol at left, it means that the power-cord plug must be unplugged from the outlet.

## ALWAYS OBSERVE THE FOLLOWING

### ⚠ WARNING

- Do not open (or modify in any way) the unit or its AC adaptor.



- Do not attempt to repair the unit, or replace parts within it (except when this manual provides specific instructions directing you to do so). Refer all servicing to your retailer, the nearest Roland Service Center, or an authorized Roland distributor, as listed on the "Information" page.



- Never install the unit in any of the following locations.
  - Subject to temperature extremes (e.g., direct sunlight in an enclosed vehicle, near a heating duct, on top of heat-generating equipment); or are
  - Damp (e.g., baths, washrooms, on wet floors); or are
  - Exposed to steam or smoke; or are
  - Subject to salt exposure; or are
  - Humid; or are
  - Exposed to rain; or are
  - Dusty or sandy; or are
  - Subject to high levels of vibration and shakiness.



- Make sure you always have the unit placed so it is level and sure to remain stable. Never place it on stands that could wobble, or on inclined surfaces.



### ⚠ WARNING

#### HP305

- The unit should be connected to a power supply only of the type described in the operating instructions, or as marked on the rear panel of unit.



#### HP302

- Be sure to use only the AC adaptor supplied with the unit. Also, make sure the line voltage at the installation matches the input voltage specified on the AC adaptor's body. Other AC adaptors may use a different polarity, or be designed for a different voltage, so their use could result in damage, malfunction, or electric shock.



- Use only the attached power-supply cord. Also, the supplied power cord must not be used with any other device.











- Do not excessively twist or bend the power cord, nor place heavy objects on it. Doing so can damage the cord, producing severed elements and short circuits. Damaged cords are fire and shock hazards!











- This unit, either alone or in combination with an amplifier and headphones or speakers, may be capable of producing sound levels that could cause permanent hearing loss. Do not operate for a long period of time at a high volume level, or at a level that is uncomfortable. If you experience any hearing loss or ringing in the ears, you should immediately stop using the unit, and consult an audiologist.



**⚠ WARNING**

- Do not allow any objects (e.g., flammable material, coins, pins); or liquids of any kind (water, soft drinks, etc.) to penetrate the unit. 
- Immediately turn the power off, remove the power cord from the outlet, and request servicing by your retailer, the nearest Roland Service Center, or an authorized Roland distributor, as listed on the "Information" page when:
  - The AC adaptor, the power-supply cord, or the plug has been damaged; or
  - If smoke or unusual odor occurs
  - Objects have fallen into, or liquid has been spilled onto the unit; or
  - The unit has been exposed to rain (or otherwise has become wet); or
  - The unit does not appear to operate normally or exhibits a marked change in performance.
- In households with small children, an adult should provide supervision until the child is capable of following all the rules essential for the safe operation of the unit. 
- Protect the unit from strong impact. (Do not drop it!) 
- Do not force the unit's power-supply cord to share an outlet with an unreasonable number of other devices. Be especially careful when using extension cords—the total power used by all devices you have connected to the extension cord's outlet must never exceed the power rating (watts/amperes) for the extension cord. Excessive loads can cause the insulation on the cord to heat up and eventually melt through. 
- Before using the unit in a foreign country, consult with your retailer, the nearest Roland Service Center, or an authorized Roland distributor, as listed on the "Information" page. 
- DO NOT play a CD-ROM disc on a conventional audio CD player. The resulting sound may be of a level that could cause permanent hearing loss. Damage to speakers or other system components may result. 
- Do not put anything that contains water (e.g., flower vases) on this unit. Also, avoid the use of insecticides, perfumes, alcohol, nail polish, spray cans, etc., near the unit. Swiftly wipe away any liquid that spills on the unit using a dry, soft cloth. 

**⚠ CAUTION**

- The unit and the AC adaptor should be located so their location or position does not interfere with their proper ventilation. 
- Always grasp only the plug on the power-supply cord and the AC adaptor when plugging into, or unplugging from, an outlet or this unit. 
- At regular intervals, you should unplug the power plug and clean it by using a dry cloth to wipe all dust and other accumulations away from its prongs. Also, disconnect the power plug from the power outlet whenever the unit is to remain unused for an extended period of time. Any accumulation of dust between the power plug and the power outlet can result in poor insulation and lead to fire. 
- Try to prevent cords and cables from becoming entangled. Also, all cords and cables should be placed so they are out of the reach of children. 
- Never climb on top of, nor place heavy objects on the unit. 
- Never handle the power cord and the AC adaptor or its plugs with wet hands when plugging into, or unplugging from, an outlet or this unit. 
- If you need to move the instrument, take note of the precautions listed below. At least two persons are required to safely lift and move the unit. It should be handled carefully, all the while keeping it level. Make sure to have a firm grip, to protect yourself from injury and the instrument from damage.
  - Check to make sure the screws securing the unit to the stand have not become loose. Fasten them again securely whenever you notice any loosening.
  - Disconnect the power cord.
  - Disconnect all cords coming from external devices.
  - Raise the adjusters on the stand (p. 22).
  - Close the lid.
  - Remove the music stand (HP302).
  - Fold down the music stand (HP305).
- Before cleaning the unit, turn off the power and unplug the power cord from the outlet (p. 18). 
- Whenever you suspect the possibility of lightning in your area, pull the plug on the power cord out of the outlet. 

 **CAUTION**

- Be careful when opening/closing the lid so you do not get your fingers pinched (p. 20). Adult supervision is recommended whenever small children use the unit.



- 
- When using the stool, please observe the following points:

- Do not use the stool as a toy, or as a stepping stool.
- Do not allow two or more persons to sit on the stool.
- Do not adjust the height while sitting on the stool.
- Do not sit on the stool if the bolts holding the stool legs are loose. (If the bolts are loose, immediately re-tighten them using the supplied tool.)
- Never insert your hand into the gap (the metal height adjustment mechanism) under the seat lid. Doing so may cause your hand to be pinched or injured.



- 
- Always keep the following small parts that may be removed out of the reach of small children to avoid accidental ingestion of these parts.

- Screws for assembling the stand you may remove
- Included wing nut for headphone hook
- Included ground terminal Screw (HP302)
- Included music rest attachment screws (HP302)
- Included stereo 1/4" plug adaptor (if a stereo 1/4" plug adaptor is included with your headphones).



---

**HP302**

- The area around the DC In jack on the rear panel may become hot, so take care to avoid burns.



# IMPORTANT NOTES

## Power Supply

- Do not connect this unit to same electrical outlet that is being used by an electrical appliance that is controlled by an inverter (such as a refrigerator, washing machine, microwave oven, or air conditioner), or that contains a motor. Depending on the way in which the electrical appliance is used, power supply noise may cause this unit to malfunction or may produce audible noise. If it is not practical to use a separate electrical outlet, connect a power supply noise filter between this unit and the electrical outlet.
- Before connecting this unit to other devices, turn off the power to all units. This will help prevent malfunctions and/or damage to speakers or other devices.
- Although the LCD and LEDs are switched off when the POWER switch is switched off, this does not mean that the unit has been completely disconnected from the source of power. If you need to turn off the power completely, first turn off the POWER switch, then unplug the power cord from the power outlet. For this reason, the outlet into which you choose to connect the power cord's plug should be one that is within easy reach and readily accessible.

## HP302

- The AC adaptor will begin to generate heat after long hours of consecutive use. This is normal, and is not a cause for concern.

## Placement

- Using the unit near power amplifiers (or other equipment containing large power transformers) may induce hum. To alleviate the problem, change the orientation of this unit; or move it farther away from the source of interference.
- This device may interfere with radio and television reception. Do not use this device in the vicinity of such receivers.
- Noise may be produced if wireless communications devices, such as cell phones, are operated in the vicinity of this unit. Such noise could occur when receiving or initiating a call, or while conversing. Should you experience such problems, you should relocate such wireless devices so they are at a greater distance from this unit, or switch them off.
- Do not expose the unit to direct sunlight, place it near devices that radiate heat, leave it inside an enclosed vehicle, or otherwise subject it to temperature extremes. Also, do not allow lighting devices that normally are used while their light source is very close to the unit (such as a piano light), or powerful spotlights to shine upon the same area of the unit for extended periods of time. Excessive heat can deform or discolor the unit.
- When moved from one location to another where the temperature and/or humidity is very different, water droplets (condensation) may form inside the unit. Damage or malfunction may result if you attempt to use the unit in this condition. Therefore, before using the unit, you must allow it to stand for several hours, until the condensation has completely evaporated.
- Do not allow rubber, vinyl, or similar materials to remain on the unit for long periods of time. Such objects can discolor or otherwise harmfully affect the finish.
- Do not allow objects to remain on top of the keyboard. This can be the cause of malfunction, such as keys ceasing to produce sound.
- Do not paste stickers, decals, or the like to this instrument. Peeling such matter off the instrument may damage the exterior finish.

## Maintenance

- To clean the unit, use a dry, soft cloth; or one that is slightly dampened. Try to wipe the entire surface using an equal amount of strength, moving the cloth along with the grain of the wood. Rubbing too hard in the same area can damage the finish.
- Never use benzene, thinners, alcohol or solvents of any kind, to avoid the possibility of discoloration and/or deformation.
- The pedals of this unit are made of brass. Brass eventually darkens as the result of the natural oxidization process. If the brass becomes tarnished, polish it using commercially available metal polisher.
- Since wood will expand and contract depending on how it is used and the environment in which it is located, products made of wood may experience a gradual loosening of the screws over time. To ensure that your piano remains in safe, optimal condition, you should regularly check the tightness of the screws in the locations shown in the illustration. If you find that any screws are loose, use a screwdriver to tighten them.

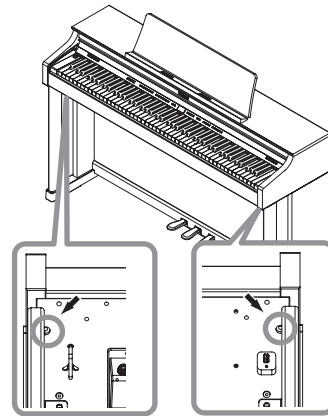

## Maintenance (Polished-finish pianos)

- Since your piano has a polished finish that is as delicate as that found on finely crafted wooden furniture, it needs careful, periodic care.
  - For regular dusting, use a soft, clean cloth and/or a piano-use feather duster. Be sure to wipe gently. Even tiny granules of grit can damage the surface of the unit if you use too much pressure when wiping.
  - If the cabinet gets dirty, wipe it with a soft cloth that has been soaked with water, then squeezed dry. Afterwards, wipe it again with a soft dry cloth. Do not use any cleaners or detergents, since they might deteriorate the surface of the cabinet, and produce cracks. Do not use dusting cloths that contain chemicals.
  - If the cabinet's surface loses its luster, wipe it thoroughly with a soft cloth dampened with a little of the piano polishing liquid.
- About piano polishing liquid
  - Use polishing liquid as directed by the instructions for the product.
  - Use only polishing liquid that is intended for use on polished-finish pianos. Using any other polishing liquid may cause scratches, deformation, or discoloration. To purchase polishing liquid, contact your nearby musical instrument dealer.
  - Use the polishing liquid only on the polished surfaces of the cabinet. Always wipe the surface with the grain using straight, even strokes. Do not repeatedly wipe the same places using too much pressure, since that might result in the loss of luster.
  - Be sure to keep the polishing liquid out of the reach of small children. If the polishing liquid is accidentally swallowed, first get them to vomit, then take them to a doctor.

## Repairs and Data

- Please be aware that all data contained in the unit's memory may be lost when the unit is sent for repairs. Important data should always be backed up on a USB memory, or written down on paper (when possible). During repairs, due care is taken to avoid the loss of data. However, in certain cases (such as when circuitry related to memory itself is out of order), we regret that it may not be possible to restore the data, and Roland assumes no liability concerning such loss of data.

## Additional Precautions

- Please be aware that the contents of memory can be irretrievably lost as a result of a malfunction, or the improper operation of the unit. To protect yourself against the risk of losing important data, we recommend that you periodically save a backup copy of important data you have stored in the unit's memory on a USB memory.
- Unfortunately, it may be impossible to restore the contents of data that was stored on an Internal Memory, a USB Memory or an external memory once it has been lost. Roland Corporation assumes no liability concerning such loss of data.
- Use a reasonable amount of care when using the unit's buttons, sliders, or other controls; and when using its jacks and connectors. Rough handling can lead to malfunctions.
- When connecting / disconnecting all cables, grasp the connector itself—never pull on the cable. This way you will avoid causing shorts, or damage to the cable's internal elements.
- To avoid disturbing your neighbors, try to keep the unit's volume at reasonable levels. You may prefer to use headphones, so you do not need to be concerned about those around you (especially when it is late at night).
- When you need to transport the unit, pack it in shock-absorbent material. Transporting the unit without doing so can cause it to become scratched or damaged, and could lead to malfunction.
- Do not apply undue force to the music stand while it is in use.
- Some connection cables contain resistors. Do not use cables that incorporate resistors for connecting to this unit. The use of such cables can cause the sound level to be extremely low, or impossible to hear. For information on cable specifications, contact the manufacturer of the cable.
- Before opening or closing the keyboard lid, always make sure that no pets or other small animals are located on top of the instrument (in particular, they should be kept away from the keyboard and its lid). Otherwise, due to the structural design of this instrument, small pets or other animals could end up getting trapped inside it. If such a situation is encountered, you must immediately switch off the power and disconnect the power cord from the outlet. You should then consult with the retailer from whom the instrument was purchased, or contact the nearest Roland Service Center.
- A small amount of heat will radiate from the unit during normal operation.

## Handling the Floppy Disk Drive

(Using Optional Floppy Disk Drive)

- Never attempt to remove a floppy disk from the drive while the drive is operating (the indicator is lit); damage could result to both the disk and the drive.

## Handling Floppy Disks

- Floppy disks contain a plastic disk with a thin coating of magnetic storage medium. Microscopic precision is required to enable storage of large amounts of data on such a small surface area. To preserve their integrity, please observe the following when handling floppy disks:
  - Never touch the magnetic medium inside the disk.
  - Do not use or store floppy disks in dirty or dusty areas.
  - Do not subject floppy disks to temperature extremes (e.g., direct sunlight in an enclosed vehicle). Recommended temperature range: 10 to 50 degrees C (50 to 122 degrees F).
  - Do not expose floppy disks to strong magnetic fields, such as those generated by loudspeakers.
- Floppy disks have a "write protect" tab which can protect the disk from accidental erasure. It is recommended that the tab be kept in the PROTECT position, and moved to the WRITE position only when you wish to write new data onto the disk.

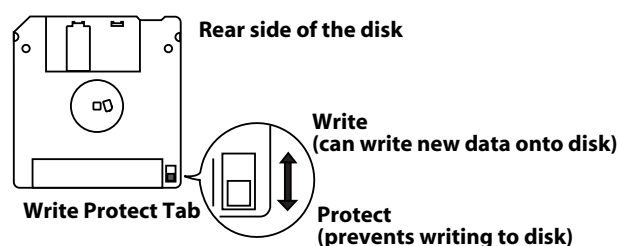

- The identification label should be firmly affixed to the disk. Should the label come loose while the disk is in the drive, it may be difficult to remove the disk.
- Store all disks in a safe place to avoid damaging them, and to protect them from dust, dirt, and other hazards. By using a dirty or dust-ridden disk, you risk damaging the disk, as well as causing the disk drive to malfunction.

## Handling Using USB memory



(Using Optional USB memory)

- Do not connect or disconnect USB memory while it is being read from, or written to (i.e., while the USB memory access indicator will blink).
- Carefully insert the USB memory all the way in—until it is firmly in place.
- Never touch the External Memory connector. Also, avoid getting the terminals dirty.
- USB memories are constructed using precision components; handle the USB memories carefully, paying particular note to the following.
  - To prevent damage to the USB memories from static electricity, be sure to discharge any static electricity from your own body before handling the USB memories.
  - Do not touch or allow metal to come into contact with the contact portion of the USB memories.
  - Do not bend, drop, or subject USB memories to strong shock or vibration.
  - Do not keep USB memories in direct sunlight, in closed vehicles, or other such locations.
  - Do not allow USB memories to become wet.
  - Do not disassemble or modify the USB memories.

## Handling CD-ROMs

(Using Optional CD-ROMs)

- Avoid touching or scratching the shiny underside (encoded surface) of the disc. Damaged or dirty CD-ROM discs may not be read properly. Keep your discs clean using a commercially available CD cleaner.

- 
- \* GS (  ) is a registered trademark of Roland Corporation.
  - \* XGlite (  ) is a registered trademark of Yamaha Corporation.
  - \* MMP (Moore Microprocessor Portfolio) refers to a patent portfolio concerned with microprocessor architecture, which was developed by Technology Properties Limited (TPL). Roland has licensed this technology from the TPL Group.
  - \* All product names mentioned in this document are trademarks or registered trademarks of their respective owners.





# Names of Things and What They Do (HP305)

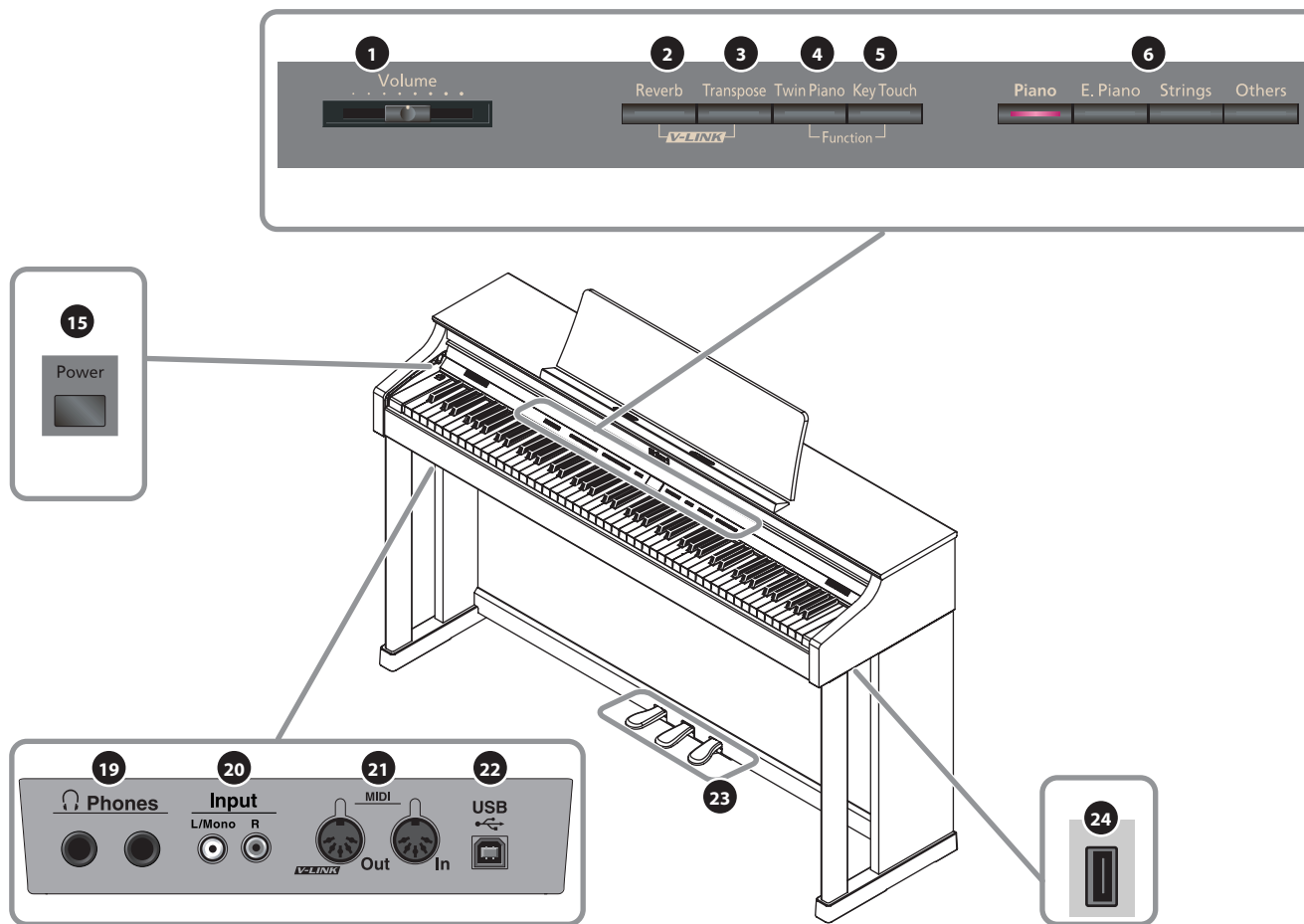

## 1 [Volume] slider

Adjusts the overall volume of the HP305 (p. 21).

## 2 [Reverb] button

Adds reverberation similar to what you would hear when performing in a concert hall (p. 29).

## 3 [Transpose] button

Transposes the keyboard and/or song.

- Transposing the keyboard (p. 37).
- Transposing the song playback (p. 42).

## 4 [Twin Piano] button

- Divides the keyboard into two separate sections, allowing two people to perform in the same registers (p. 32).
- Allows you to perform with a split keyboard (p. 34).

## 5 [Key Touch] button

- Used to adjust the touch sensitivity of the keyboard (p. 30).
- Additionally, if you hold down this button while you press the [Twin Piano] button, you will enter Function mode, where you can make settings for the sounds and make changes in a variety of the instrument's functions (p. 55).

## 6 Tone buttons

Here you can select the sound you'll hear when you play the keyboard (p. 25).

## 7 [Display] button

- Switches the content of the display.
- Displays the song number, the metronome's tempo or time signature (p. 26).

## 8 Indicators

These indicate the content shown in the display.

- Song indicator: The display shows the song number.
- Tempo indicator: The display shows the tempo.
- Beat indicator: The display shows the time signature.

## 9 Display

This shows the tone number, song number, tempo, time signature, and the value of various settings.

## 10 [-] (◀◀) [+] (▶▶) buttons

- Change the value of settings such as sounds or functions.
- Select the sound to be played from the keyboard (p. 25).
- Select a song (p. 39).
- Fast-forward/rewind a song (p. 39).

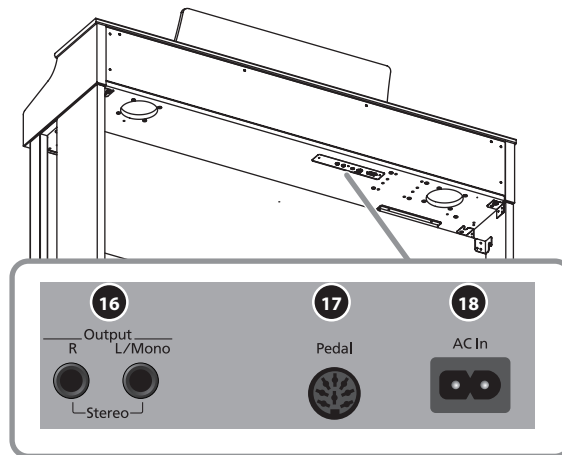
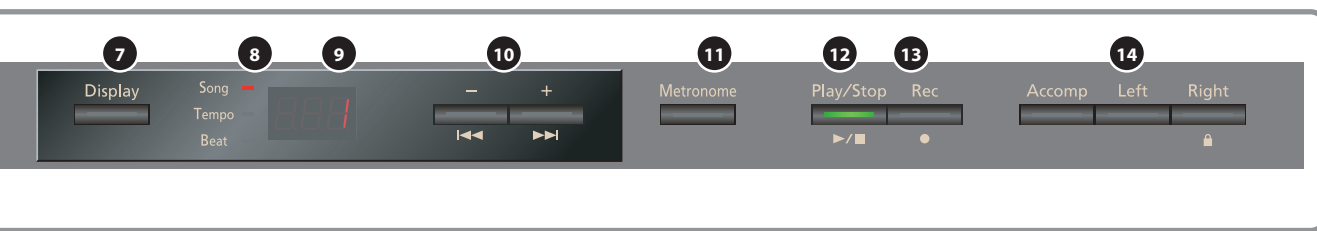

### 11 [Metronome] button

Turns the internal metronome on/off (p. 26).

### 12 [▶/■] (Play/Stop) button

- Stops/starts playback of an internal song or a recorded performance (p. 39).
- Starts/stops recording of your performance (p. 43).

### 13 [●] (Rec) button

This lets you record your own performance into the HP305 (p. 43).

### 14 Track buttons

- Allows you to play back your performance separately for each hand (p. 40).
- Records your performance separately for each hand (p. 50).
- Holding down the [Right] button will disable all button operations (Panel Lock) (p. 38).

### 15 [Power] switch

Turns the power on/off (p. 21).

### 16 Output jacks (L/Mono, R)

You can connect an audio device or external powered speakers here to reproduce the HP305's sound (p. 67).

### 17 Pedal connector

Connect the pedal cord of the dedicated stand to this connector (p. 18).

### 18 AC In (AC Inlet)

Connect the included power cord here (p. 18).

### 19 Phones jacks

Here you can connect headphones (p. 23).

### 20 Input jacks (L/Mono, R)

Here you can connect an audio device or another electronic musical instrument, and listen to the connected device through the HP305's speakers (p. 67).

### 21 MIDI Out/In connectors

You can connect these to external MIDI devices to transfer performance data (p. 69).

### 22 USB connector

You can connect this to your computer for transferring performance data (p. 72).

### 23 Pedal

- These are used mainly when playing piano (p. 22).
- You can assign a variety of functions to the pedals (p. 59).

### 24 External Memory connector

Here you can connect USB memory, a CD drive, or a floppy disk drive, and use it to play or save songs (p. 62).



# Names of Things and What They Do (HP302)

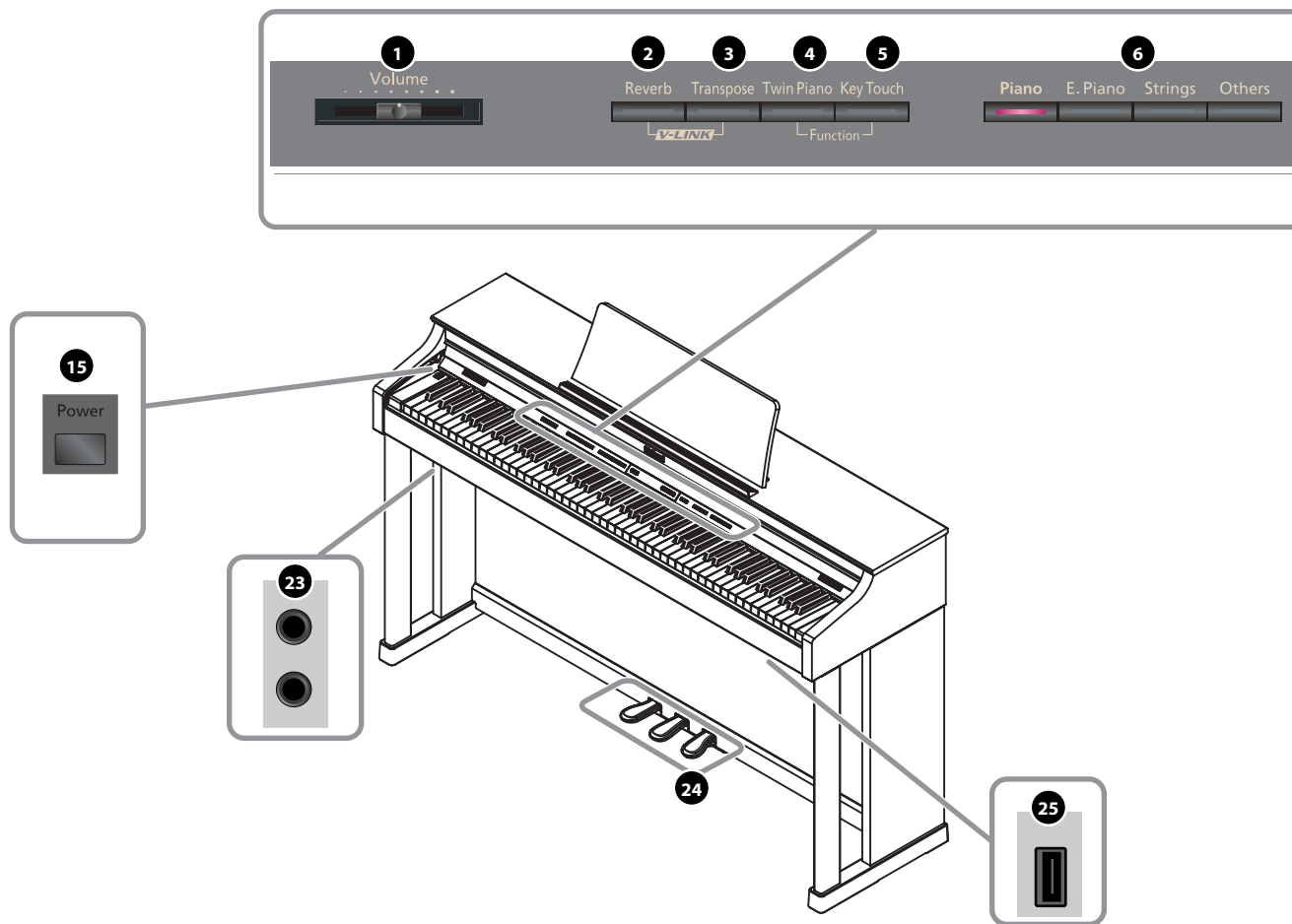

## 1 [Volume] slider

Adjusts the overall volume of the HP302 (p. 21).

## 2 [Reverb] button

Adds reverberation similar to what you would hear when performing in a concert hall (p. 29).

## 3 [Transpose] button

Transposes the keyboard and/or song.

- Transposing the keyboard (p. 37).
- Transposing the song playback (p. 42).

## 4 [Twin Piano] button

- Divides the keyboard into two separate sections, allowing two people to perform in the same registers (p. 32).
- Allows you to perform with a split keyboard (p. 34).

## 5 [Key Touch] button

- Used to adjust the touch sensitivity of the keyboard (p. 30).
- Additionally, if you hold down this button while you press the [Twin Piano] button, you will enter Function mode, where you can make settings for the sounds and make changes in a variety of the instrument's functions (p. 55).

## 6 Tone buttons

Here you can select the sound you'll hear when you play the keyboard (p. 25).

## 7 [Display] button

- Switches the content of the display.
- Displays the song number, the metronome's tempo or time signature (p. 26).

## 8 Indicators

These indicate the content shown in the display.

- Song indicator: The display shows the song number.
- Tempo indicator: The display shows the tempo.
- Beat indicator: The display shows the time signature.

## 9 Display

This shows the sound number, song number, tempo, time signature, and the value of various settings.

## 10 [-] ( I◀◀ ) [ + ] ( ▶▶ I ) button

- Change the value of settings such as sounds or functions.
- Select the sound to be played from the keyboard (p. 25).
- Select a song (p. 39).
- Fast-forward/rewind a song (p. 39)

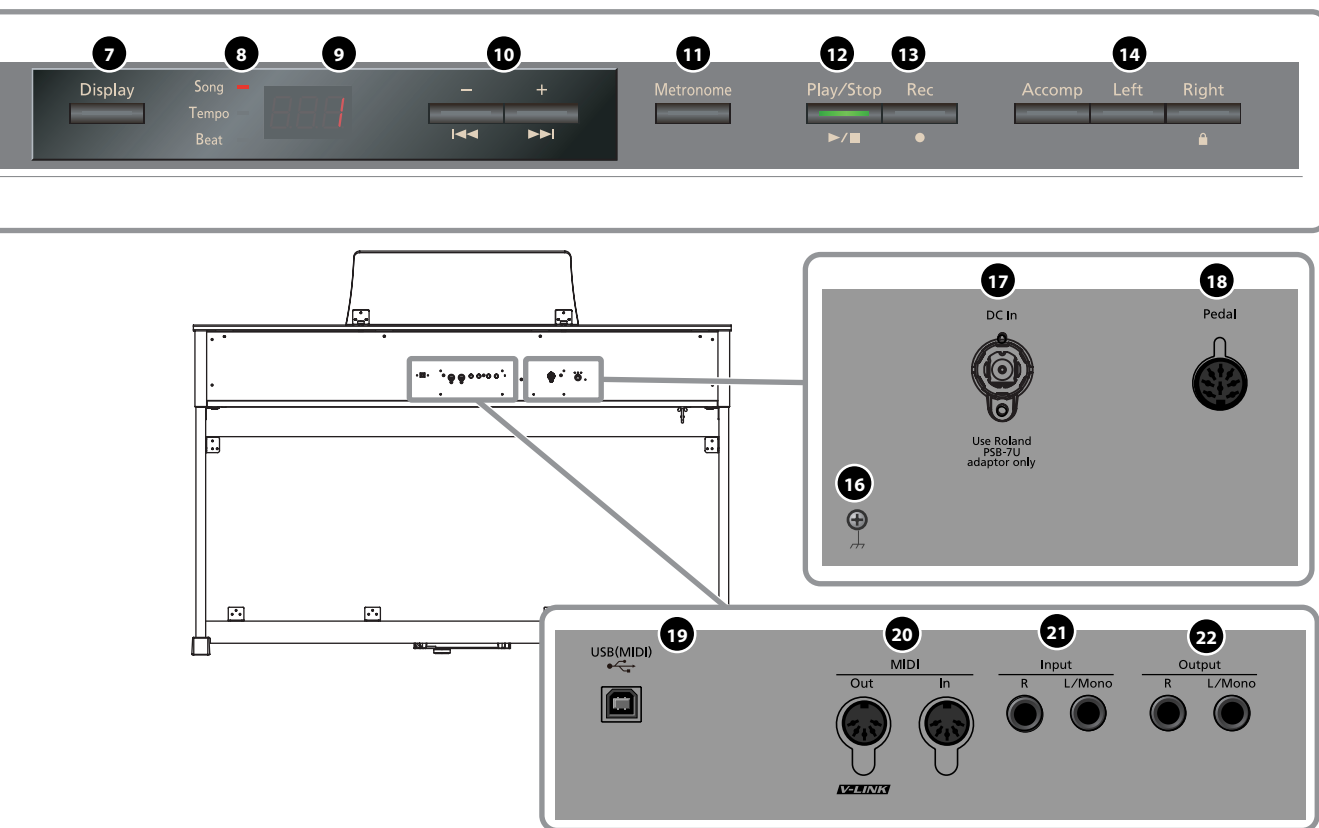
**11 [Metronome] button**

Turns the internal metronome on/off (p. 26).

**12 [▶/■] (Play/Stop) button**

- Stops/starts playback of an internal song or a recorded performance (p. 39).
- Starts/stops recording of your performance (p. 43).

**13 [●] (Rec) button**

This lets you record your own performance into the HP302 (p. 43).

**14 Track buttons**

- Allows you to play back your performance separately for each hand (p. 40).
- Records your performance separately for each hand (p. 50).
- Holding down the [Right] button will disable all button operations (Panel Lock) (p. 38).

**15 [Power] switch**

Turns the power on/off (p. 21).

**16 Ground terminal**

For added safety, you can connect this screw to a grounding rod or a grounded earth wire (p. 19).

**17 DC In jack (DC Inlet)**

Connect the supplied AC adaptor here (p. 18).

**18 Pedal connector**

Connect the pedal cord of the dedicated stand to this connector (p. 18).

**19 USB connector**

You can connect this to your computer for transferring performance data (p. 72).

**20 MIDI Out/In connectors**

You can connect these to external MIDI devices to transfer performance data (p. 69).

**21 Input jacks (L/Mono, R)**

Here you can connect an audio device or another electronic musical instrument, and listen to the connected device through the HP302's speakers (p. 67).

**22 Output jacks (L/Mono, R)**

You can connect an audio device or external powered speakers here to reproduce the HP302's sound (p. 67).

**23 Phones jacks**

Here you can connect headphones (p. 23).

**24 Pedal**

- These are used mainly when playing piano (p. 22).
- You can assign a variety of functions to the pedals (p. 59).

**25 External Memory connector**

Here you can connect USB memory, a CD drive, or a floppy disk drive, and use it to play or save songs (p. 62).



# Before You Play

## Getting Ready to Play

### Connecting the Pedal Cord (HP305)

Plug the pedal cord extending from the stand into the Pedal connector located at the rear of the HP305's bottom panel.

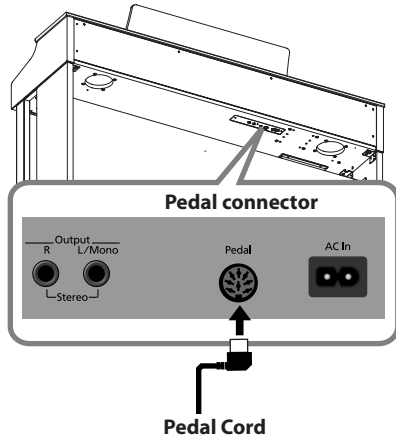

### Connecting the Pedal Cord (HP302)

Plug the pedal cord extending from the stand into the Pedal connector located at the rear of the HP302's panel.

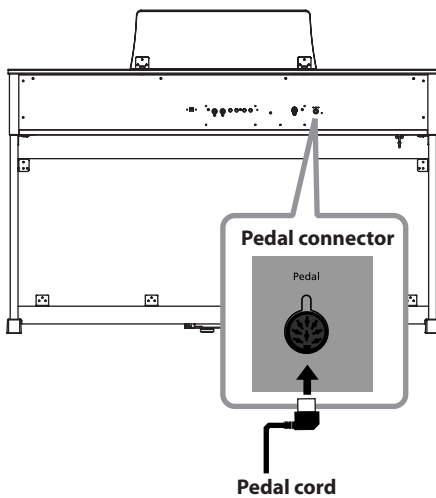

### Connecting the Power Cord (HP305)

#### Check before you connect the power cord.

- Make sure that the [Power] switch is off (p. 21).
- Make sure that the [Volume] slider is minimized (p. 21).

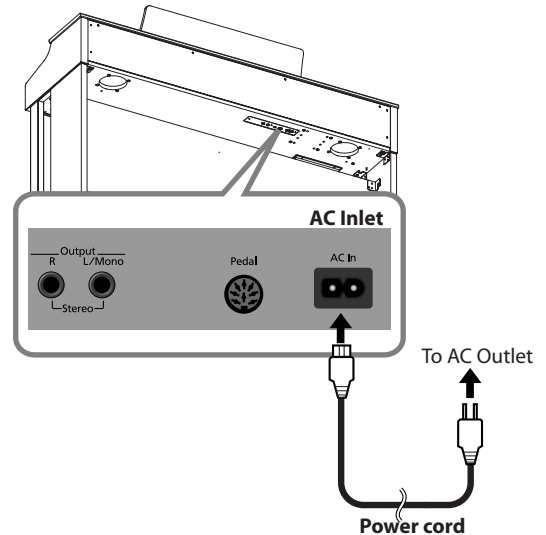

1. Connect the included power cord to the AC Inlet located at the rear of the bottom panel.

2. Plug the other end of the power cord into an AC outlet.

#### NOTE

You must use the power cord included with the HP305.

### Connecting the AC Adaptor (HP302)

#### Check before you connect the AC Adaptor.

- Make sure that the [Power] switch is off (p. 21).
- Make sure that the [Volume] slider is minimized (p. 21).

1. Connect the supplied AC adaptor and power cord.

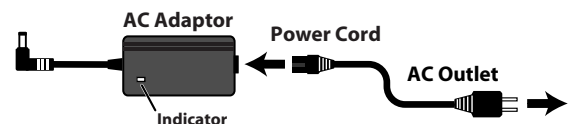

#### NOTE

Place the AC adaptor so the side with the indicator (see illustration) faces upwards and the side with textual information faces downwards.

The indicator will light when you plug the AC adaptor into an AC outlet.

## 2. Connect the AC adaptor to the DC In jack on the rear panel.

### NOTE

Take care not to pull the cord with excessive force, or strain it. Doing so may damage or break the cord.

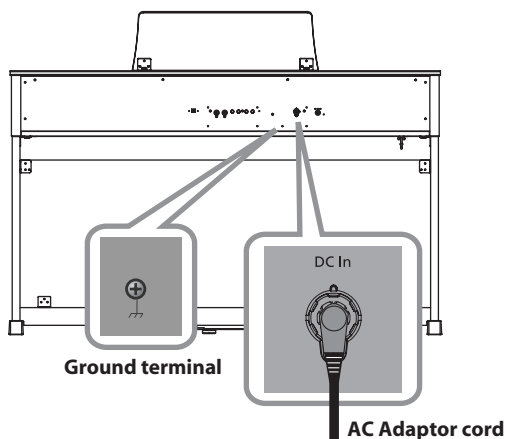

## 3. Plug the Power cord into a power outlet.

### NOTE

Be sure to use only the AC adaptor supplied with the unit. Also, make sure the line voltage at the installation matches the input voltage specified on the AC adaptor's body. Other AC adaptors may use a different polarity, or be designed for a different voltage, so their use could result in damage, malfunction, or electric shock

\* Depending on the circumstances of a particular setup, you may experience a discomforting sensation, or perceive that the surface feels gritty to the touch when you touch this device, microphones connected to it, or the metal portions of other objects, such as guitars. This is due to an infinitesimal electrical charge, which is absolutely harmless. However, if you are concerned about this, connect the ground terminal (see figure) with an external ground. When the unit is grounded, a slight hum may occur, depending on the particulars of your installation. If you are unsure of the connection method, contact the nearest Roland Service Center, or an authorized Roland distributor, as listed on the "Information" page.

Unsuitable places for connection

- Water pipes (may result in shock or electrocution)
- Gas pipes (may result in fire or explosion)
- Telephone-line ground or lightning rod (may be dangerous in the event of lightning)

## Setting up the Music Rest (HP305)

### Raising the music rest

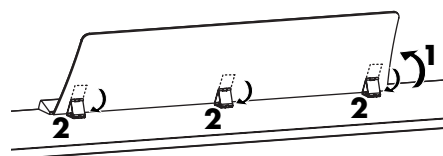

1. Gently raise the music rest.
2. Fold down the latches to secure the music rest.

### Folding down the music rest

Raise the latches located on the back of the music rest, then gently fold down the music rest.

### Using the music holders

You can use the holders to hold pages in place.

When not using the holders, leave them folded down.

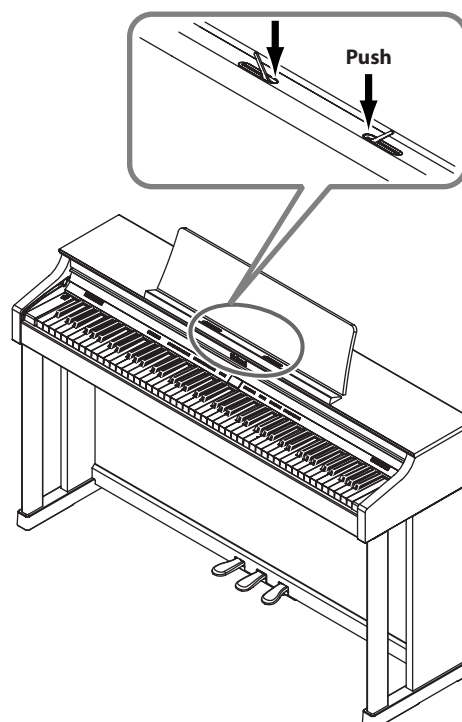

## Setting up the Music Rest (HP302)

Attach the included music rest using the procedure described below.

- 1. Insert the included music rest attachment screws into the screw holes on top of the HP302, and tighten the screws slightly.**

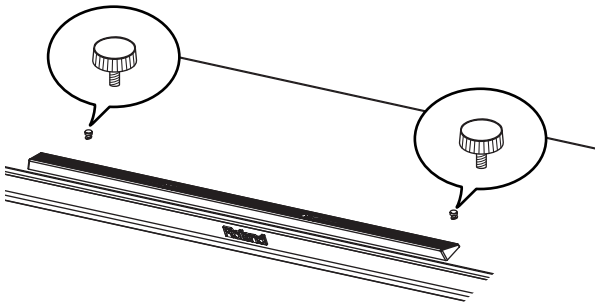

- 2. Put the music rest between the screws and the HP302's body.**

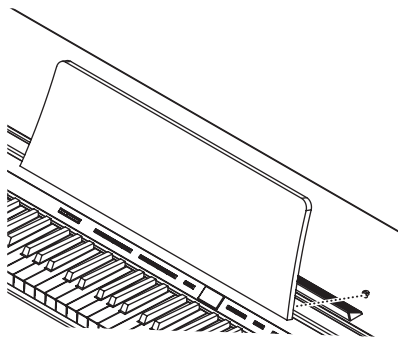

- 3. While supporting the music rest with one hand, secure it in place by turning the screws.**

When attaching the music rest, support it firmly with one hand to make sure that you don't drop it. Be careful, so you don't get your fingers pinched.

- 4. To remove the music rest, support it with one hand while loosening the screws.**

After removing the music rest, don't forget to retighten the screws.

**NOTE** Do not apply excessive force to the installed music rest.

**NOTE** Be sure to use the supplied screws for attaching the music rest.

**NOTE** Before moving the piano, be sure to remove the music rest to prevent accidents.

**NOTE** Be careful not to lose the screws used to fasten the music rest, or allow small children to accidentally swallow them.

## Using the music holders

You can use the holders to hold pages in place.

When not using the holders, leave them folded down.

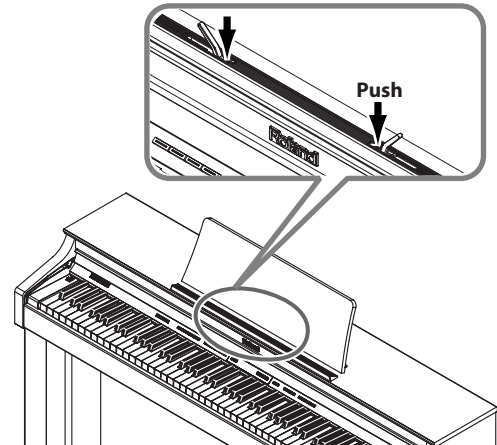

## Opening/Closing the Lid

To open the lid, use both hands to lift it lightly, and slide it away from yourself.

To close the lid, pull it gently toward yourself, and lower it softly after it has been fully extended.

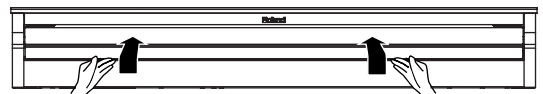

**NOTE** When opening and closing the lid, be careful not to let your fingers get caught. If small children will be using the HP305/HP302, adult supervision should be provided.

**NOTE** If you need to move the piano, make sure the lid is closed first to prevent accidents.

## Using the lid to conceal the buttons and display (Classic Position)

You can use the lid to conceal the buttons and the display. This allows you to concentrate on performing without being distracted by the buttons or the display.

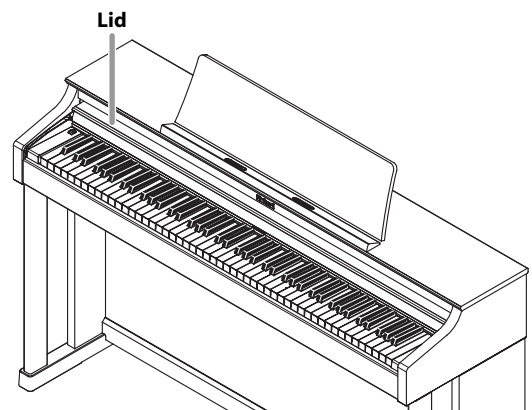



## Turning the Power On/Off

### NOTE

Once the connections have been completed (p. 18), turn on power to your various devices in the order specified. By turning on devices in the wrong order, you risk causing malfunction and/or damage to speakers and other devices.

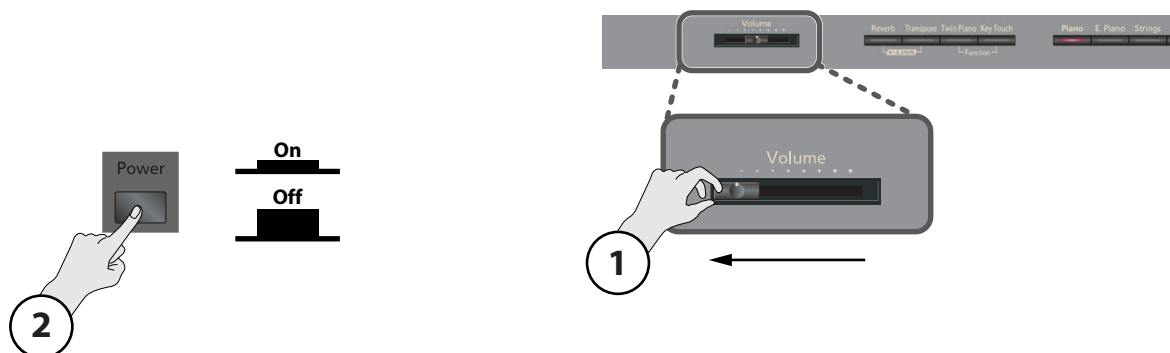

### Turning the Power On

1. Move the [Volume] slider all the way to the left to minimize the volume.
2. Press the [Power] switch.

The power will turn on, and [Piano] button and [Reverb] button will light.

After a brief interval, you'll be able to produce sounds by playing the keyboard.

- \* This unit is equipped with a protection circuit. A brief interval (a few seconds) after power up is required before the unit will operate normally.
- \* Always make sure to have the volume level turned down before switching on power. Even with the volume all the way down, you may still hear some sound when the power is switched on, but this is normal, and does not indicate a malfunction.

3. Use the [Volume] slider to adjust the volume (p. 21).

### Turning the Power Off

1. Move the [Volume] slider all the way to the left to minimize the volume.
2. Press the [Power] switch.

The screen goes blank and the power is turned off.

### NOTE

If you need to turn off the power completely, first turn off the [POWER] switch, then unplug the power cord from the power outlet. Refer to "Connecting the Power Cord (HP305)" (p. 18) or "Connecting the AC Adaptor (HP302)" (p. 18).

## Adjusting the Sound's Volume

Here's how to adjust the volume of your keyboard playing or the playback volume of an internal song or USB memory song. If headphones are connected, use the [Volume] slider to adjust the headphone volume.

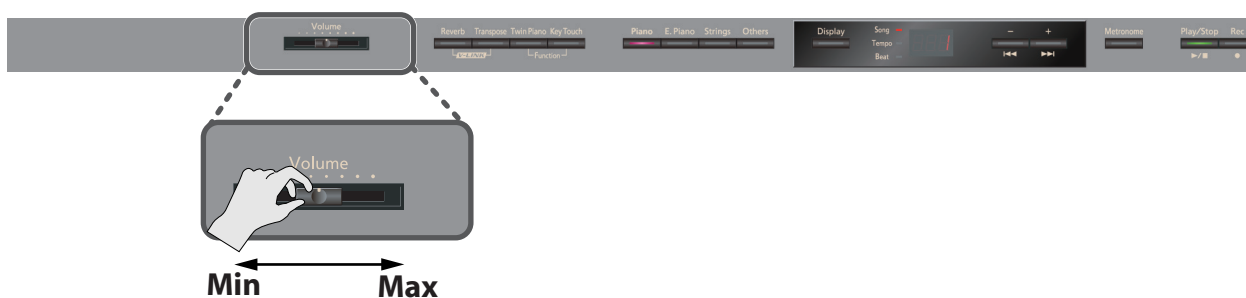

1. Turn the [Volume] slider to adjust the overall volume.

Adjust the volume while you play the keyboard to produce sound.

Turning the knob toward the right will increase the volume, and turning it toward the left will decrease the volume.

## Using the Pedals

The pedals perform the following operations. You'll use them mainly when playing piano.

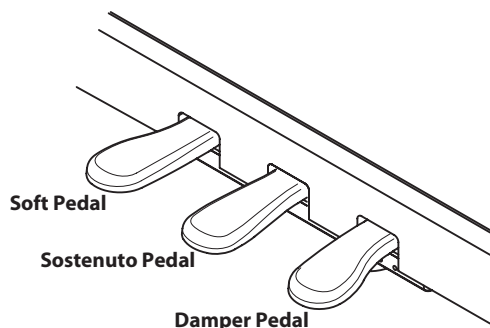

### Damper Pedal (right pedal)

Use this pedal to sustain the sound.

While this pedal is held down, notes will be sustained for an extended time even if you release your fingers from the keyboard.

The length of sustain will change subtly depending on how deeply you press the pedal.

On an acoustic piano, holding down the damper pedal will cause the strings for notes other than the ones you actually play to vibrate in sympathy with what you've played, producing a rich resonance. The HP305/HP302 simulates this sympathetic vibration (damper resonance).

#### MEMO

You can modify the sound of the sympathetic vibration (p. 59).

### Sostenuto Pedal (center pedal)

The notes you are pressing when this pedal is depressed will be sustained.

### Soft Pedal (left pedal)

This pedal is used to make the sound softer.

Playing with the soft pedal depressed produces a sound that is not as strong as when otherwise played with the equivalent strength. This is the same function as the left pedal of an acoustic piano.

The softness of the tone can be varied subtly by the depth to which you press the pedal.

#### MEMO

You can switch the function of the sostenuto pedal and the soft pedal (p. 59).

#### NOTE

If you disconnect the pedal cord from the HP305/HP302 while the power is turned on, the pedal effect will remain applied. You must connect or disconnect the pedal cord while the HP305/HP302's power is switched off.

## About the Adjuster

If you feel that the pedal is unstable (for example if you've moved the HP305/HP302 to a different location), you can adjust the adjuster located on the bottom of the pedals as follows.

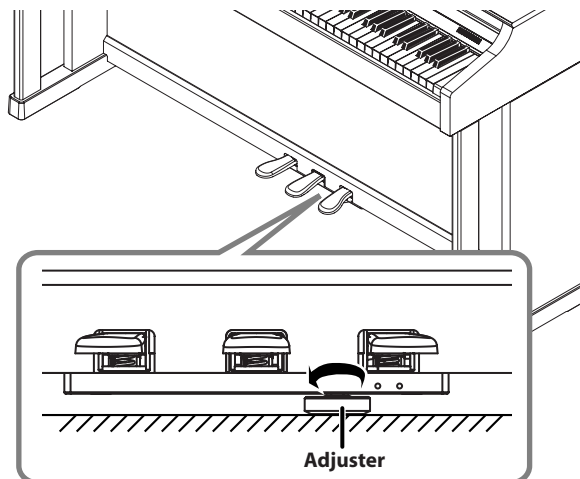

Turn the adjuster to lower it until the adjuster is in firm contact with the floor. The pedal may be damaged if there is a gap between the adjuster and the floor. In particular, when you've placed the HP305/HP302 on carpet, you must turn the adjuster until it is pressing firmly against the floor.

## Using the Headphones

You can use headphones to enjoy the HP305/HP302 without disturbing those around you, such as at night.

### Connecting the Headphones

The HP305/HP302 has two headphone jacks, two people can also use headphones simultaneously.

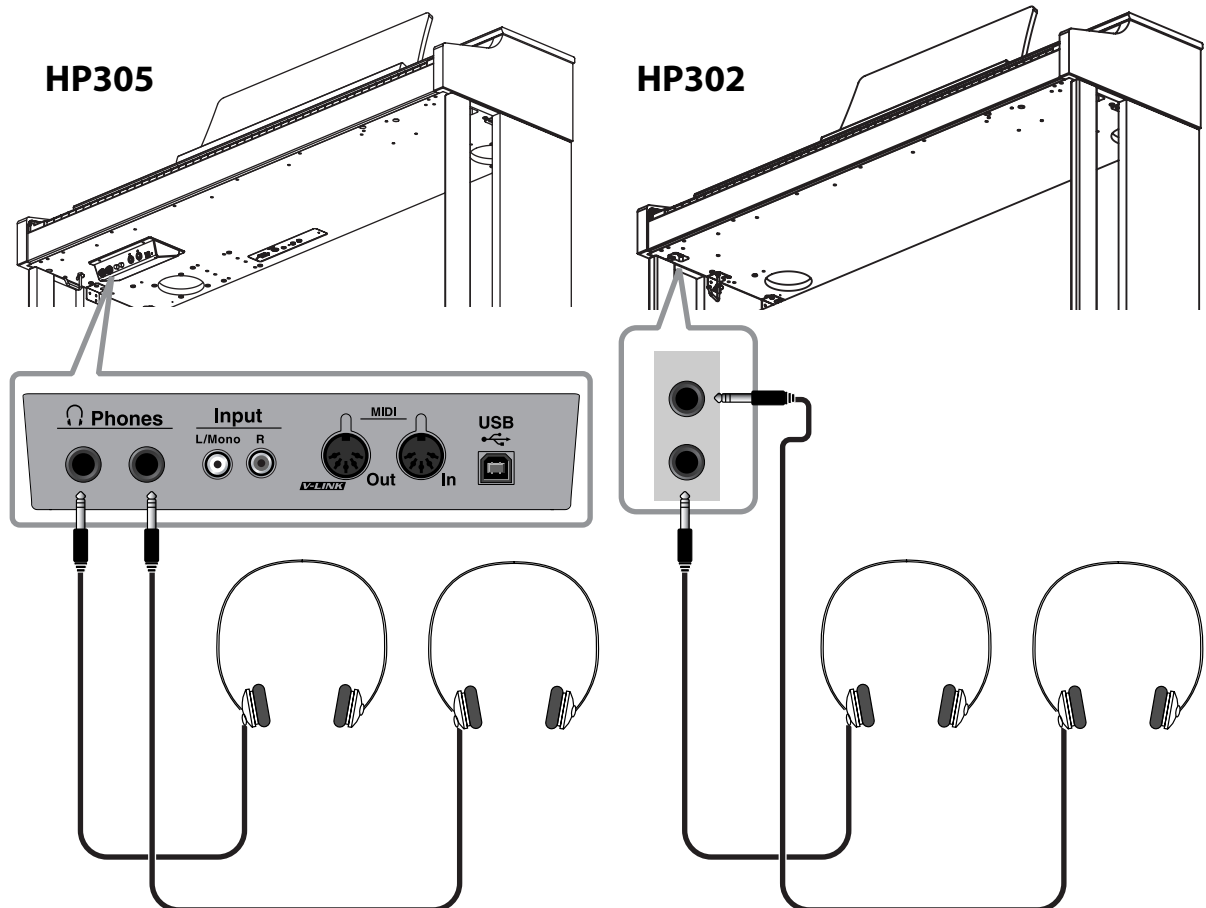

**1. Plug the headphones into the Phone jack.**

If headphones are connected, no sound will be output from the HP305/HP302's speakers.

**2. Use the HP305/HP302's [Volume] slider to adjust the headphone volume (p. 21).**

## Using the Headphone Hook

Whenever you are not using the headphones, you can hang them on the headphone hook of the HP305/HP302.

### Attaching the Headphone Hook

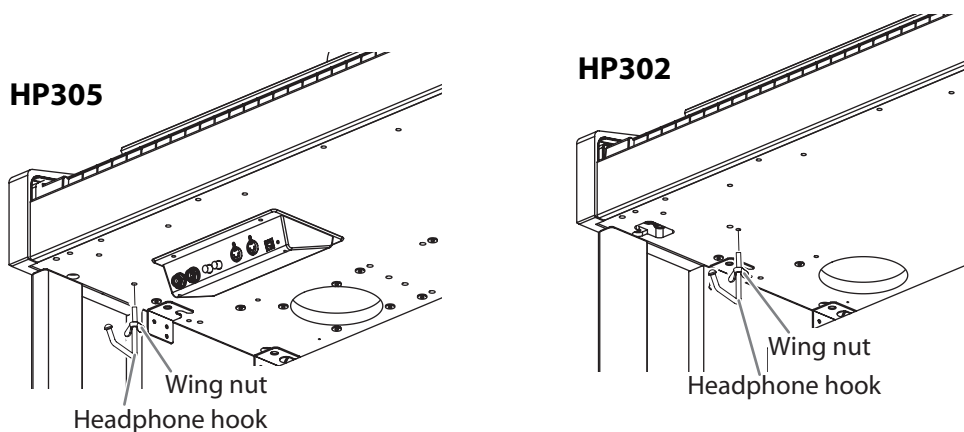

1. Press and twist the headphone hook included with the HP305/HP302 into the hole in the bottom left of the HP305/HP302 (refer to the figure above).
2. Turn the headphone hook wing nut to secure the headphone hook.

#### **NOTE**

Do not hang anything other than headphones on the headphone hook. Doing so may damage the instrument or the hook.

### Cautions when Using Headphones

- To prevent damage to the cord's internal conductors, avoid rough handling. When using headphones, mainly try to handle either the plug or the headset.
- Your headphones may be damaged if the volume of a device is already turned up when you plug them in. Minimize the volume before you plug in the headphones.
- Excessive input will not only damage your hearing, but may also strain the headphones. Please enjoy music at an appropriate volume.
- Use headphones that have a stereo 1/4" phone plug.

# Performing

## Performing with Various Sounds

In addition to piano sounds, the HP305/HP302 lets you enjoy performing with many other sounds (over 300 types). These sounds are called "Tones." The Tones are divided into four groups, each of which is assigned to a different Tone button.

Let's start by performing with a piano tone.

When you turn on the power, the "Grand Piano1" Tone is selected.

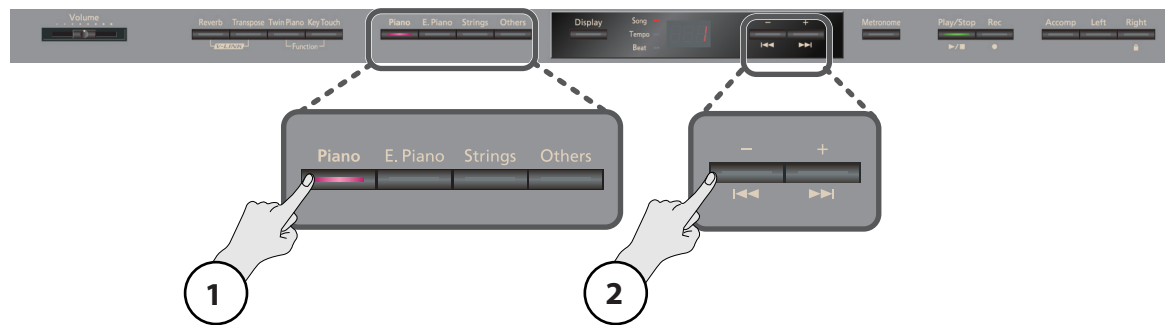

### 1. Press the [Piano] button.

The currently selected tone number is shown.



### 2. Press the [-] or [+] button.

A different tone is selected.



#### MEMO

If you don't perform any operation for a while, the indication in the display will change to the following.



### About the tones you can select

Button	Description
[Piano] button	Selects a variety of instruments, including grand pianos, honky-tonk pianos, and historical instruments.
[E. Piano] button	Selects various electric piano sounds used in pop or rock, as well as the sound of instruments played using mallets.
[Strings] button	Selects the sounds of string instruments such as violins, as well as other instruments used in orchestras, which are appropriate when used for Dual play with a piano sound.
[Others] button	Selects a variety of sounds such as organ, bass, and GM2 sounds (p. 83). * If you select a tone number from 35 through 43, the keyboard will act as a drum set. * If you've selected a tone to which the Rotary effect is applied, pressing the [Others] button will change the modulation speed of the Rotary effect.

\* For some tones, there are keys that do not produce sound.

\* For details on the tones, refer to "Tone List" (p. 78).

## Performing with the Metronome

You can sound the metronome while you perform.

The HP305/HP302 contains a versatile metronome feature. You can change the metronome's volume and time signature, or change the way in which it divides the beats.

While the song plays, the metronome will sound at the tempo and time signature of the song.



### 1. Press the [Metronome] button.

The [Metronome] button will blink, and the display will indicate "Tempo."

The metronome will sound.

The [Metronome] button will blink red and green according to the currently selected time signature; red indicates the strong beats, and green indicates the weak beats.

**MEMO**

You can press the [Metronome] button once again to stop the metronome.



## Changing the Metronome's Tempo

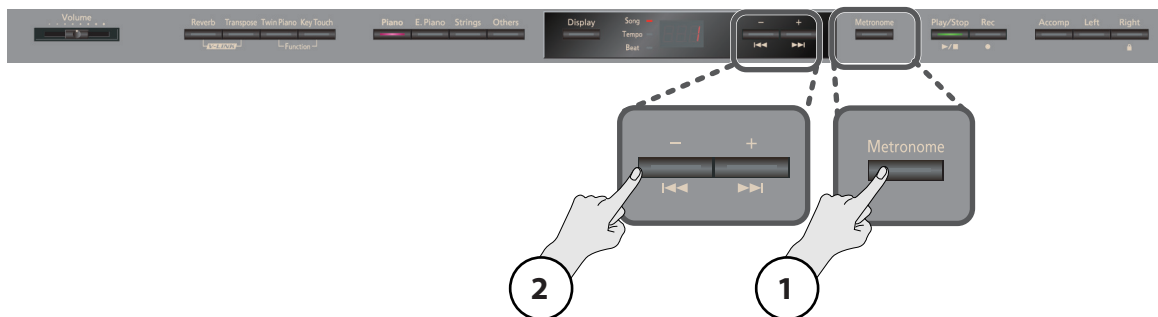





### 1. Press the [Metronome] button.

The metronome will sound.



### 2. Press the [-] or [+] button.

### Correspondence between beat and tempo display

<b>Beat</b>	2/2	0/4, 2/4, 3/4, 4/4, 5/4, 6/4, 7/4	3/8	6/8, 9/8, 12/8
<b>Tempo</b>	 =5-250	 =10-500	 =20-999	 =7-333

## Changing the Metronome's Time Signature

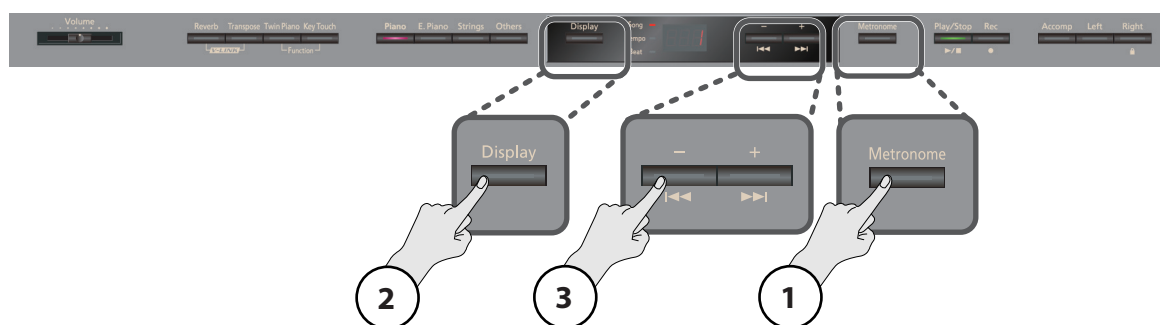

**1. Press the [Metronome] button.**

The metronome will sound.

**2. Press the [Display] button.**

The Beat indicator will light, and the display will indicate the time signature.



**3. Press the [-] or [+] button.**

If you specify "0/4" only the weak beats will sound.

If you record your performance, it will be recorded with the time signature you specify here.

When you play back a song, the metronome's time signature will be set to the time signature of that song.

Indicate	Beat	Indicate	Beat
	2/2		6/4
	0/4 (Only weak beats will be sounded.)		7/4
	2/4		3/8
	3/4		6/8
	4/4		9/8
	5/4		12/8

\* You can't change the metronome's time signature while a song is playing.



## Adjusting the Metronome's Volume

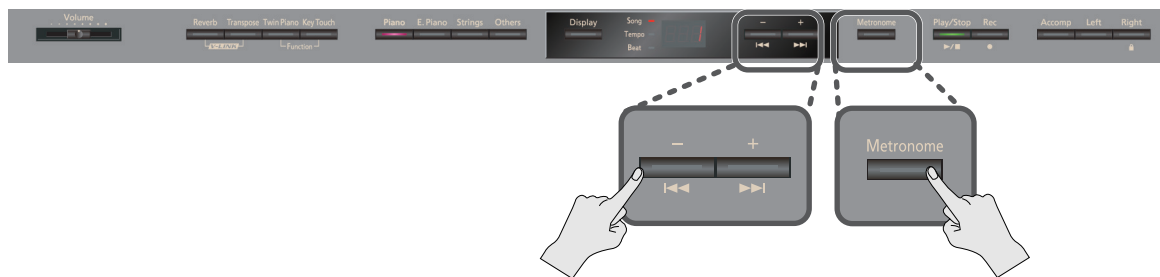

1. **While holding down the [Metronome] button, press the [-] or [+] button.**

The display will indicate the metronome's volume.

If you set the metronome's volume to "0" the metronome will not sound.



<b>Metronome volume range</b>	0-10
-------------------------------	------

## Adding a Count-in to Synchronize Your Performance (Count-in)

A series of sounds rhythmically played to indicate the tempo before a song starts is called a "count-in."

If you sound a count-in, it will be easier for you to synchronize your own performance to the tempo of the playback.

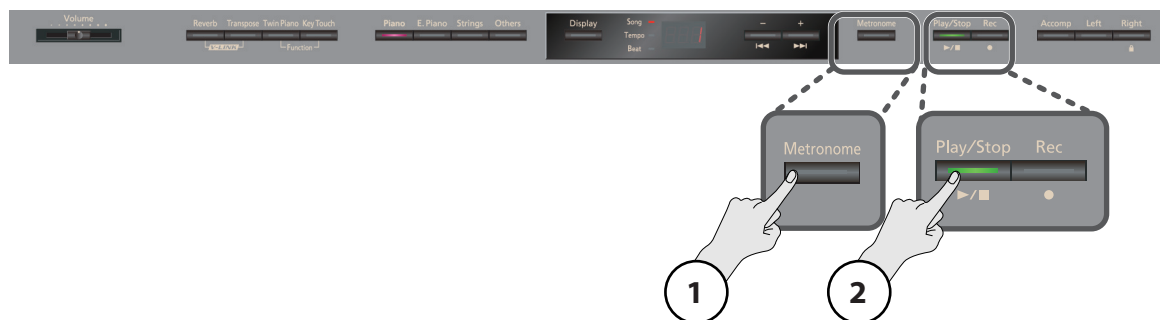

1. **Press the [Metronome] button.**

The metronome will sound.

2. **Press the [▶/■] button.**

A two-measure count sound will be produced before the song starts playing.

## Adding Reverberation to the Sound (Reverb)

You can add a pleasant reverberation to the sounds you play from the keyboard, producing the impression that you are performing in a concert hall. This effect is called "Reverb."

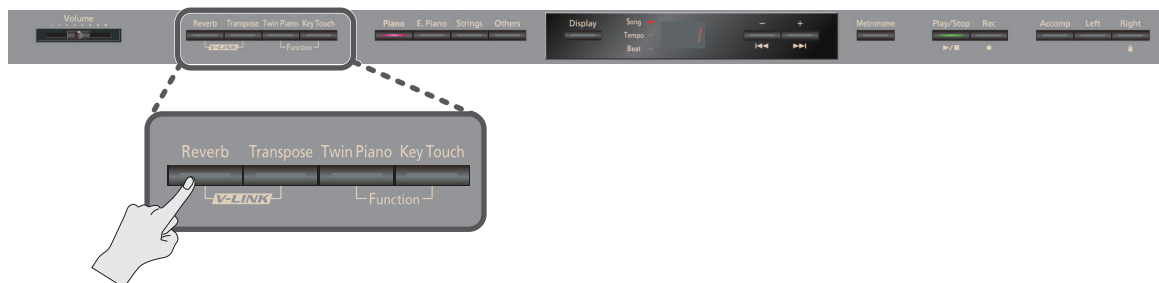

### 1. Press the [Reverb] button.

The [Reverb] button will light.

#### MEMO

If you press the [Reverb] button once again, the button will go out and the reverb effect will be eliminated.

## Adjusting the Depth of the Reverb Effect

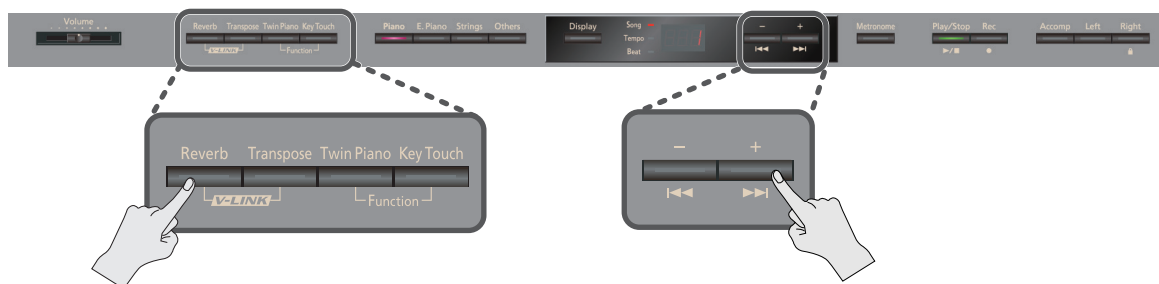

### 1. While holding down the [Reverb] button, press the [-] or [+] button.

The display will indicate the depth of the reverb effect values.

<b>Reverb depth range</b>	1 – 10
---------------------------	--------

Higher values apply deeper reverb.

#### MEMO

The adjusted setting will return to its previous value when you turn off the power. If you wish, you can have this setting be retained even while the power is turned off (p. 21).

- \* You can't specify the depth of the reverb effect independently for each sound. Reverb is applied at the same depth for each sound.
- \* The depth of the reverb effect for the song that's playing will not change.
- \* The reverb effect is not applied if Twin Piano mode (p. 33) is set to Individual.

### What are Effects?

In addition to reverb, the HP305/HP302 provides a wide variety of other "effects" that can modify the sound in various ways. An appropriate effect is selected for each different tone.

- \* Some tones do not have an effect.

## Adjusting the Keyboard Sensitivity (Key Touch)

You can change the touch sensitivity, or response of the keys. You can adjust the keyboard touch as appropriate for the playing strength of the person who is performing.

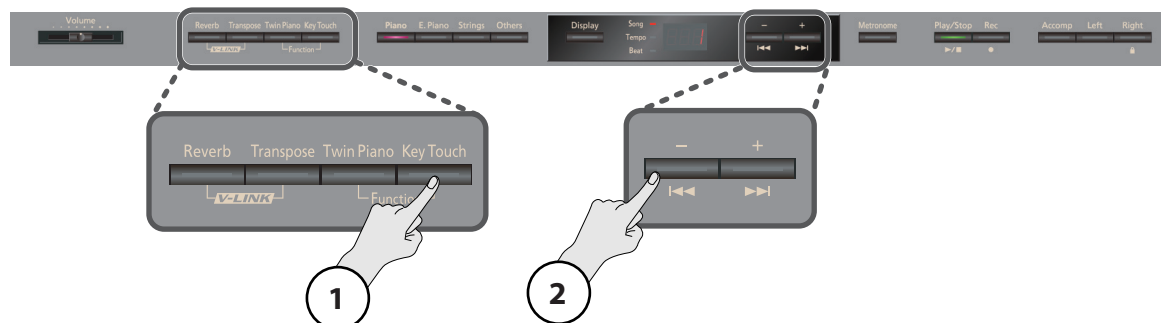

1. Press the [Key Touch] button so it's flash.
2. Press the [-] or [+] button to select the keyboard touch.



Indicate	Description
Fixed 	The sound plays at one set volume, regardless of the force used to play the keys.
Extra Light 	This setting produces the lightest keyboard touch.
Light 	You can achieve fortissimo (ff) play with a less forceful touch than "medium," so the keyboard feels lighter. This setting makes it easy to play, even for children.
Medium 	This sets the standard keyboard touch. You can play with the most natural touch. This is the closest to the touch of an acoustic piano.
Heavy 	You have to finger the keyboard more forcefully than "medium" in order to play fortissimo (ff), so the keyboard touch feels heavier. Dynamic fingering adds even more feeling to what you play.
Extra Heavy 	This setting produces the heaviest keyboard touch.

3. Press the [Key Touch] button to return to selection of tones.

If a setting other than "-M-(Medium)" is selected, the [Key Touch] button will be lit.

**MEMO**

You can use the Memory Backup function to store this setting in internal memory (p. 61).

## Performing with Two Layered Tones (Dual Play)

You can play two tones simultaneously from each note of the keyboard. This feature is called "Dual Play."

As an example, here's how to layer piano and strings tones.

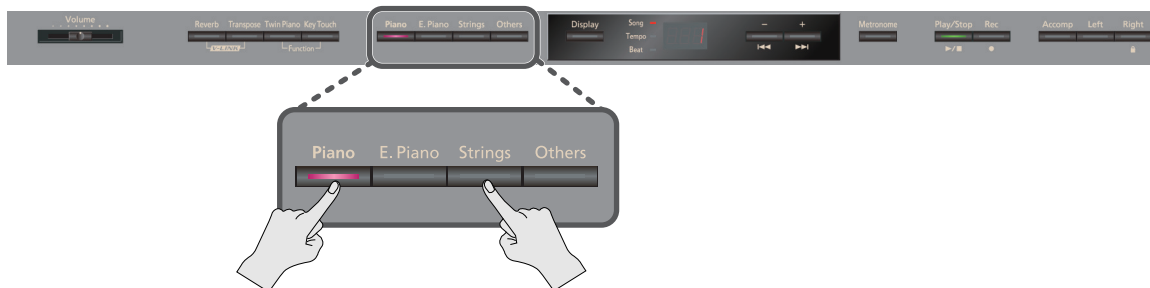

### 1. Hold down the [Piano] button and press the [Strings] button.

Both buttons will light.

When you play the keyboard, you'll hear both the piano and the strings tones.

### About the tones

Tone name	Corresponding button	How to select tones
Tone 1	Left tone button	Press the [-] or [+] button.
Tone 2	Right tone button	Hold down the Tone button for Tone 2 (the rightmost of the lit Tone buttons), and press the [-] or [+] button.

#### MEMO

When you press any tone button, Dual play will be cancelled; you'll hear only the tone of the button you pressed.

#### MEMO

You can change the pitch of tone 2 in steps of an octave (p. 57).

#### MEMO

When you press a damper pedal while using Dual play, the effect will apply to both tone 1 and tone 2, but you may change this so that the effect applies to only one tone (p. 59).

#### MEMO

You can change the volume balance of the two tones (p. 58).

- \* Dual play is not available if Split play or Twin Piano are turned on.
- \* For some combinations of sounds, the effect is not applied to tone 2, and this may affect how the tone sounds.

## Dividing the Keyboard for Two-person Performance (Twin Piano)

You can divide the keyboard into left and right zones so that two people can play the same range of pitches, just as though there were two pianos.

This function is called "Twin Piano."

For example, you could use Twin Piano to allow a student to play along with their teacher.

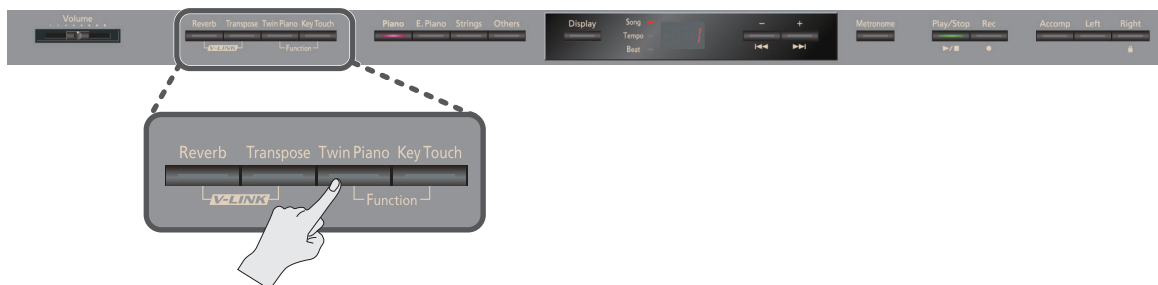

### 1. Press the [Twin Piano] button.

The [Twin Piano] button will light.



When you turn Twin Piano on, the keyboard, the pedals, and the tone will change to the following settings.

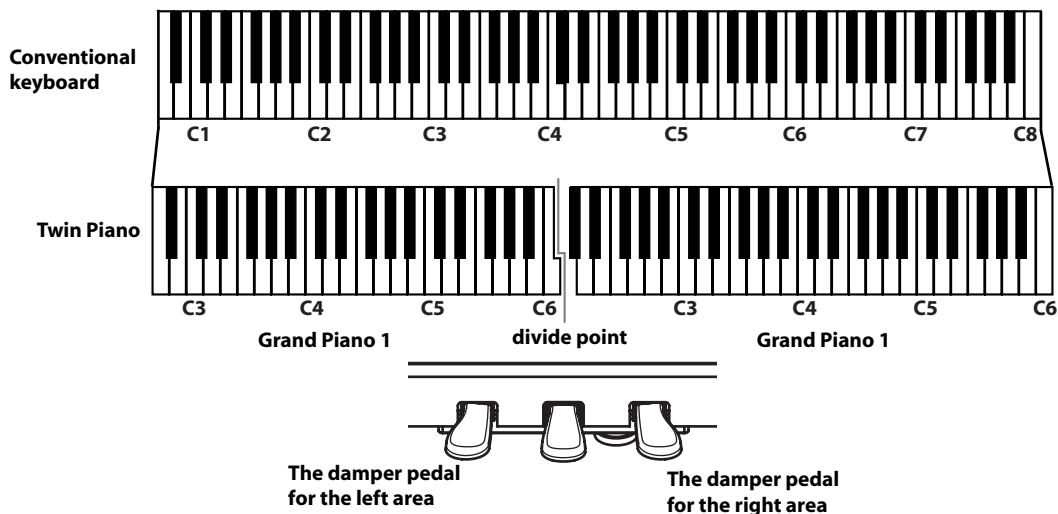

#### MEMO

When you press the [Twin Piano] button a number of times, the Twin Piano function will turn off and the [Twin Piano] button will go out.

\* Since some effects (p. 29) will no longer be applied if Twin Piano is turned on, this may change the sound of the tone.

## Changing the Way in Which the Sound is Heard (Twin Piano Mode)

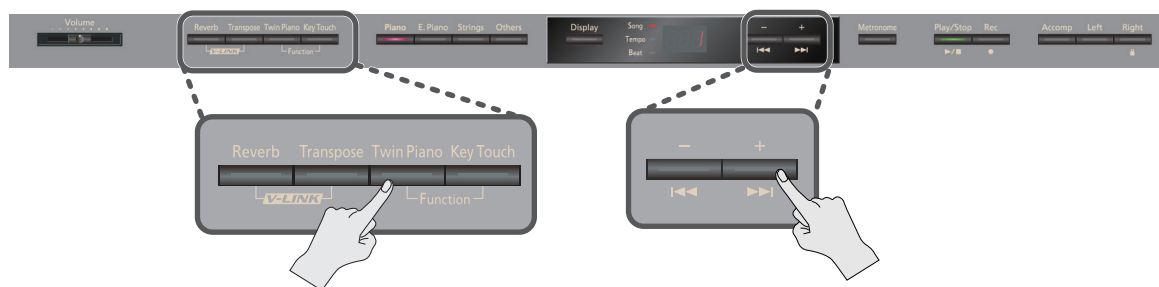

1. Hold down the [Twin Piano] button and press the [-] or [+] button.



Value	Description
1 (Pair)	The sound of the right-hand keyboard zone will be heard more loudly from the right speaker than from the left speaker. The sound of the left-hand keyboard zone will be heard more loudly from the left speaker than from the right speaker.
2 (Individual)	The sound of the right-hand keyboard zone will be heard only from the right speaker. The sound of the left-hand keyboard zone will be heard only from the left speaker. * The reverb effect will be turned off. * For some tones, the sound may not be split between left and right.  <b>For the HP305</b> * If you play in the left-hand keyboard zone, you won't hear sound from the headphones that are connected to the right Phones jack. Conversely, when you play in the right-hand keyboard zone, you won't hear sound from the left headphones.  <b>For the HP302</b> * If you play in the left-hand keyboard zone, the sound will not be heard in the headphones connected to the rear Phones jack. Similarly, if you play in the right-hand keyboard zone, the sound will not be heard in the headphones connected to the front Phones jack.

### MEMO

The settings you change will return to their original values when you turn off the power.  
If you wish, you can have this setting be remembered even while the power is turned off (p. 61).

## Playing Different Tones in the Left and Right Sides of the Keyboard (Split Play)

You can play different tones in the left and right sides of the keyboard, divided at a certain key. This feature is called "Split Play," and the key at which the keyboard is divided is called the "Split Point."

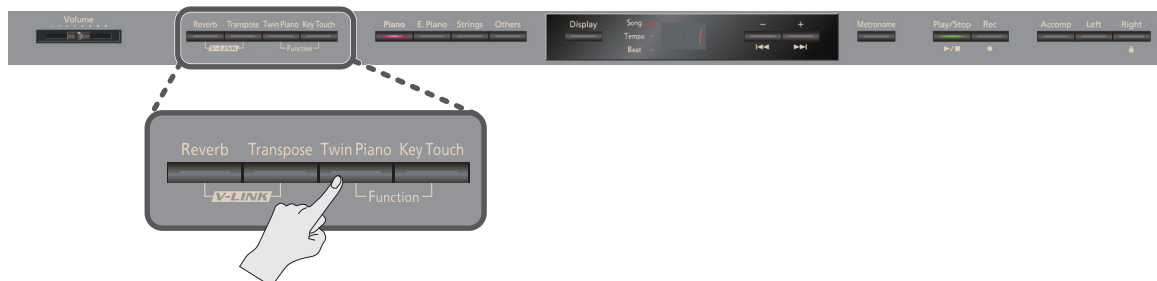

1. Press the [Twin Piano] button a number of times so the Split screen will appear.



When Split is turned on, the keyboard settings will be as follows.

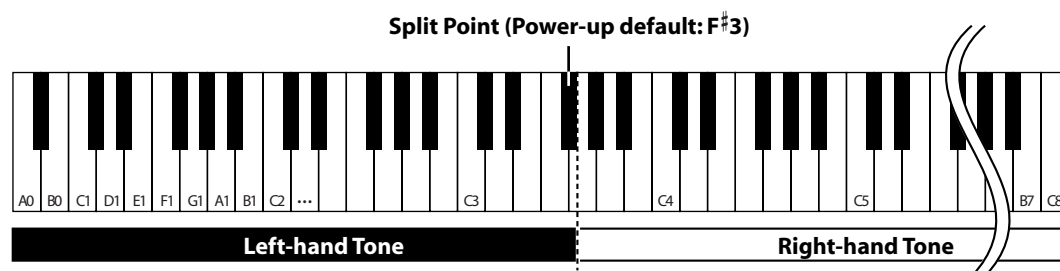

**MEMO**

Press the [Twin Piano] button a number of times to turn off Split play; the [Twin Piano] button will go out.



## Changing the Tones of the Left and Right Zones

### Changing the right-hand tone

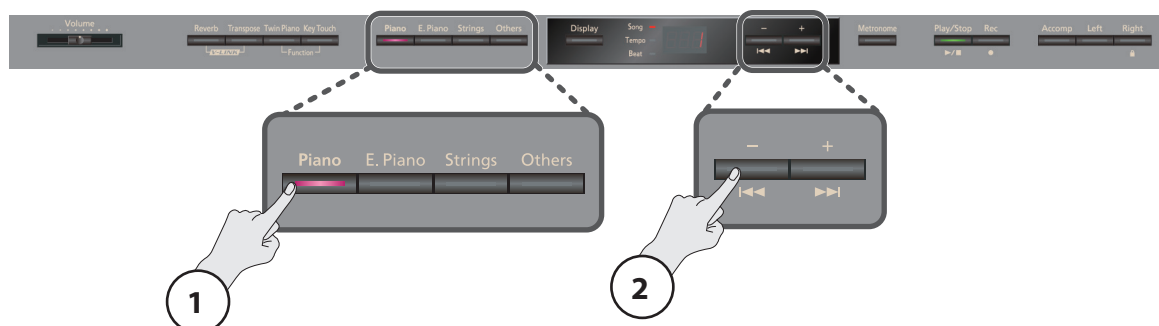

**1. Press a tone button.**

The number of the currently selected for the right-hand zone are shown.



**2. Press the [-] or [+] button.**

A different tone is selected.

### Changing the left-hand tone

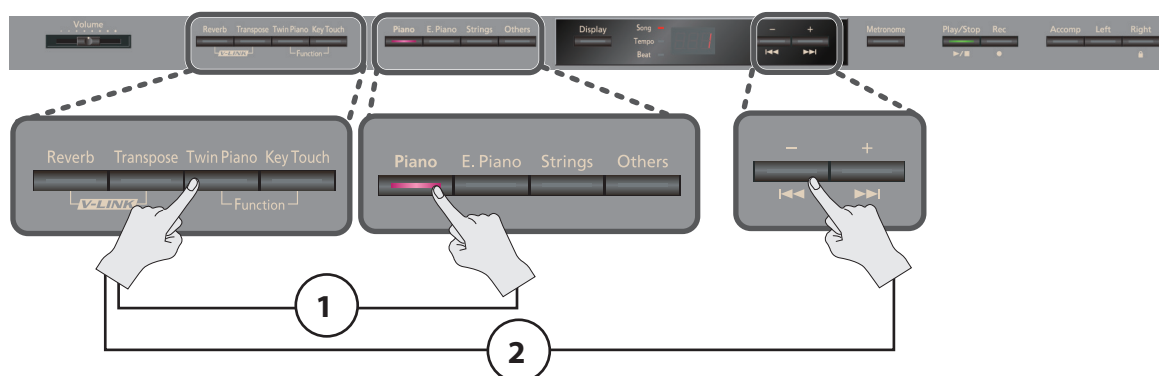

**1. Hold down the [Twin Piano] button and press a tone button.**

The number of the tone currently selected for the left-hand zone are shown.



**2. While holding down the [Twin Piano] button, press the [-] or [+] button.**

A different tone is selected.

**MEMO**

You can change the pitch of the left-hand sounds in steps of an octave (p. 57).

## Changing the Keyboard's Split Point

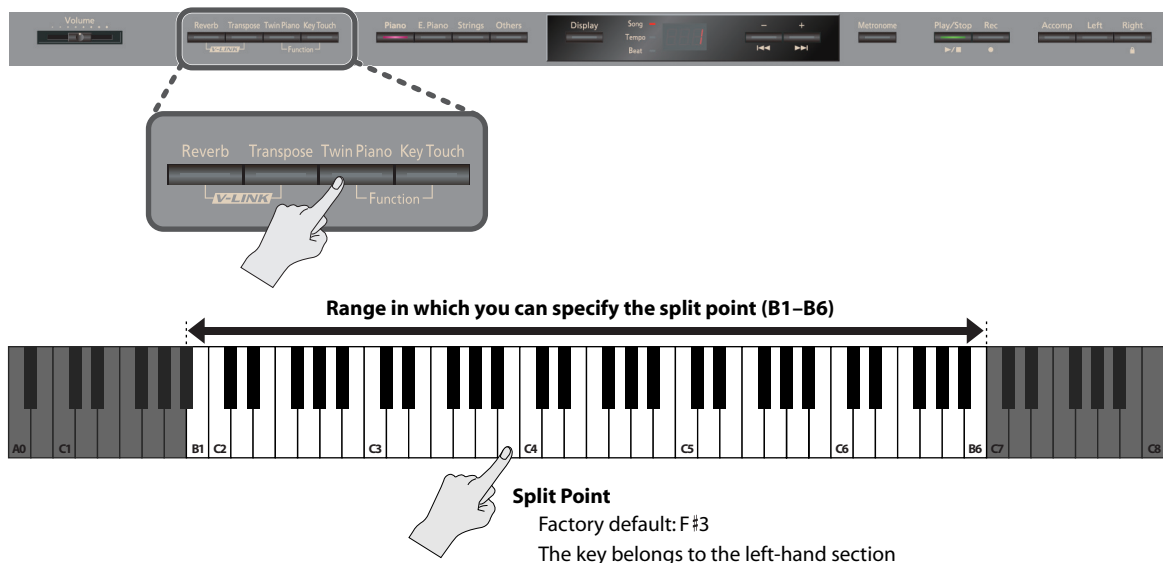

1. Hold down the [Twin Piano] button and press the key that you want to be the new split point.

The key you pressed becomes the new split point, and that key will be shown in the display. When you release the [Twin Piano] button, the display will return to its previous indication.



### How the Split Point is shown

When indicating the key that is the split point, the display shows the note name followed by a number that signifies the octave.

Display	Note name	Display	Note name
	C		F#
	C#		G
	D		A <sup>b</sup>
	E <sup>b</sup>		A
	E		B <sup>b</sup>
	F		B

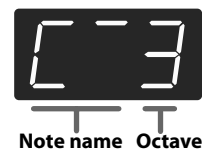

**MEMO**

The changed setting will revert to its original state when you turn off the power. If you wish, you can have this setting be remembered even while the power is turned off (p. 61).

## Transposing the Keyboard (Transpose)

“Transpose” means to shift the pitches produced by the keyboard.

The Transpose function makes it easy to do the following.

- The pitch of your accompaniment can be adjusted to a singer’s vocal range without changing your fingering (i.e., without changing the keys you play).
- A song written in a difficult key with numerous sharps (#) or flats (♭) can be performed in a key that’s easier for you to play.

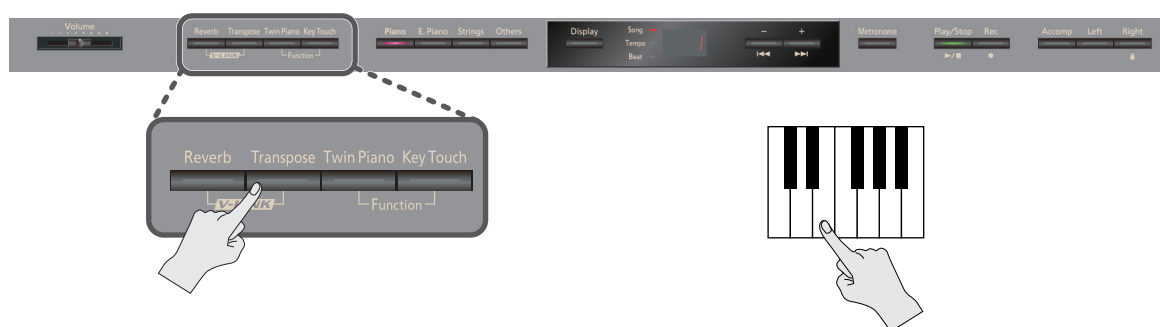

### 1. Hold down the [Transpose] button and play the key that’s the tonic of the key into which you want to transpose.

The current transposition setting is shown while you hold down the [Transpose] button.



**MEMO**

You can also change the transposition setting by using the [-] or [+] buttons while holding down the [Transpose] button.

<b>Transposition range</b>	-6-0-5 (semitone units)
----------------------------	-------------------------

If a setting other than 0 is selected, the [Transpose] button will be lit.

**MEMO**

To return to the original value (0), hold down the [Transpose] button and press both of the [-] or [+] buttons simultaneously.

**MEMO**

You can use the [Transpose] button to turn the Transpose function on/off (if the transposition setting is other than “0”).

**MEMO**

The HP305/HP302 allows you to transpose both the keyboard and the song, or just the keyboard, or just the song (p. 57). With the factory settings, the keyboard and the song will be transposed together.

\* If the Transpose Mode (p. 57) is set to “SnG” (the song playback), the Transpose function will not affect the pitches of the keyboard.

### Example: Use C major fingering to play a song written in E major

#### 1. Hold down the [Transpose] button and press the E note (the tonic note for the key of E major).

Counting from C as a reference point, the tonic note for the key of E major is four chromatic steps higher, so the display indicates “4.”

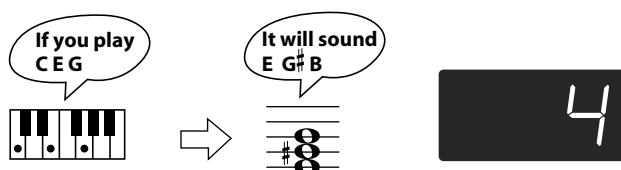

**MEMO**

The transposition value will return to “0” when you switch songs or turn off the power.

## Disabling the Buttons (Panel Lock)

The Panel Lock setting lets you disable all of the HP305/HP302's buttons. In this state, the settings will not change even if you inadvertently press a button while performing.

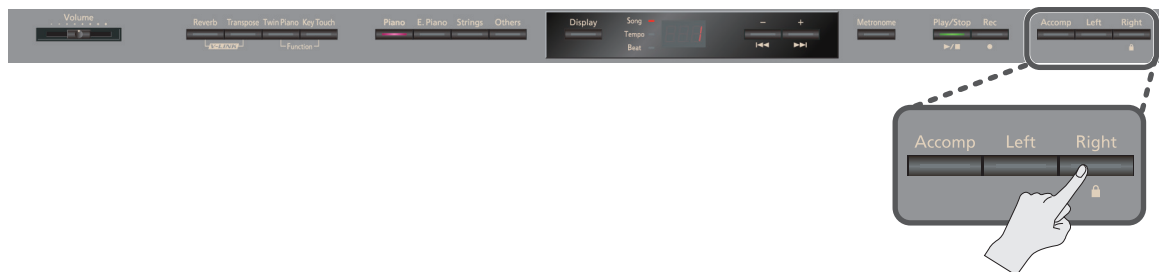

### 1. Hold down the [Right] button for a while.

Panel Lock will be activated.

#### **MEMO**

To cancel Panel Lock, once again hold down the [Right] button for a while. Panel Lock will also be cancelled when you turn off the power.

- \* If you activate Panel Lock while a song is playing or being recorded, playback or recording will stop.
- \* You can't activate Panel Lock while in Function mode (p. 55).





# Listening to Songs

## Playing Back Songs

Here's how to listen to the built-in songs. The HP305/HP302 provides 72 built-in piano songs.

**MEMO**

You can also play back songs from a separately sold floppy disk drive, CD drive, or USB memory (p. 64).

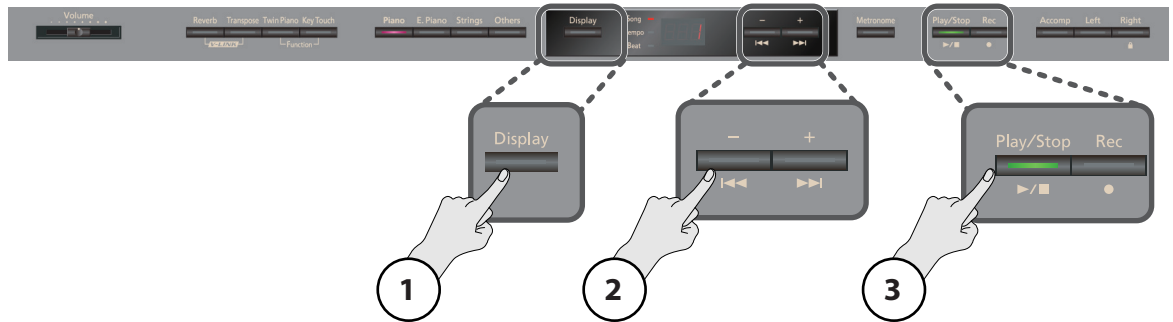

1. Press the [Display] button a number of times so the Song indicator will light.
2. Press the [-] or [+] button to select a song.
3. Press the [▶/■] button.



When the song has played to its end, playback will stop.

To pause the playback, press the [▶/■] button once again.

The next time you press the [▶/■] button, playback will resume from where you paused.

### Fast-forward and rewind

Operation	Button
To beginning of next song	Press the [▶▶▶] button
To beginning of current song	Press the [◀◀◀] button
Fast-forward the song	Hold down the [▶▶▶] button while the song is playing
Rewind the song	Hold down the [◀◀◀] button while the song is playing

**MEMO**

For details on the names of the internal songs, refer to "Internal Song List" (p. 81).

## Playing Parts Individually

The parts of an internal song can be selected and played individually. This allows you to practice playing the left or right-hand part of a song while listening to the other hand played automatically.

### Performance parts and tracks

Each part is assigned to the track buttons as shown in the illustration.

### Muting

You can "mute" a specific part so that it will not be heard.

\* The [Accomp] button will not light if you've selected a song that does not contain an accompaniment.

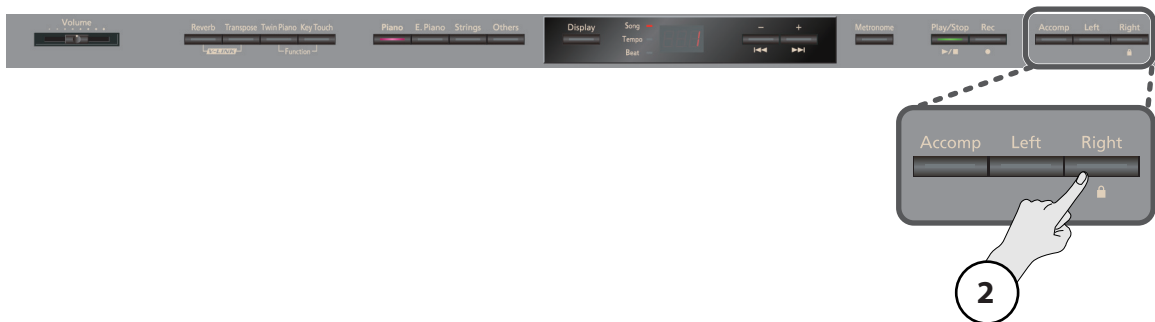
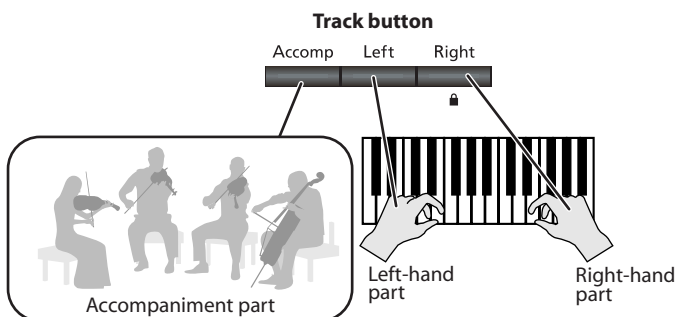

1. **Play back a song (p. 39).**

2. **Press the track button for the part that you don't want to be played.**

The light for the button you pressed will go out, and the selected part will not be heard.

When you press the track button once again so it's lit, the part will be heard again.

#### MEMO

You can change the volume of the muted part (p. 60).

#### MEMO

By playing back a song with the accompaniment part muted, you can skip the introduction.

#### MEMO

The mute setting will be cancelled when you switch songs.

### Practicing the right-hand part by itself

1. **Press the [Right] button.**

The button will go out.

2. **Press the [▶/■] button.**

The HP305/HP302 will play the left-hand part and accompaniment part, allowing you to practice the right-hand part separately.

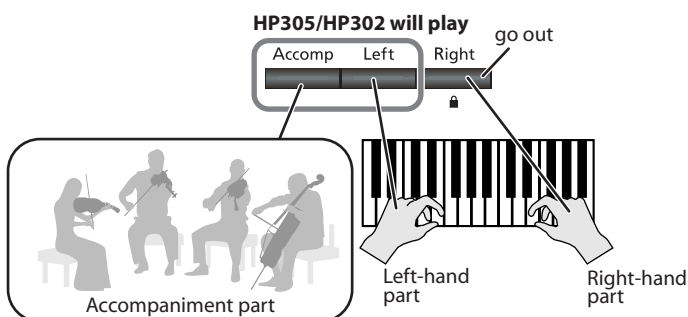

## Playing All Songs Consecutively (All Songs Play)

You can have the HP305/HP302 play all internal songs (or all songs in internal memory, or all songs in USB memory) repeatedly in succession.

This function is called "All Songs Play."

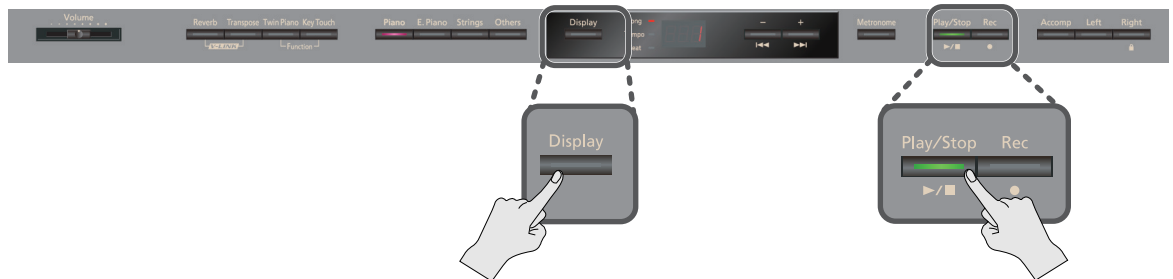

1. **Hold down the [Display] button and press the [▶/■] button.**

All Songs Play will be selected, and the display will indicate "ALL."

ALL

\* The All Songs Play function will turn off when you stop playback or turn off the power.

## Adjusting the Volume of the Song Playback

You can adjust the volume at which the song plays.

This is helpful when you want to adjust the volume balance between your keyboard playing and the song playback; for example, when you're practicing along with a song.

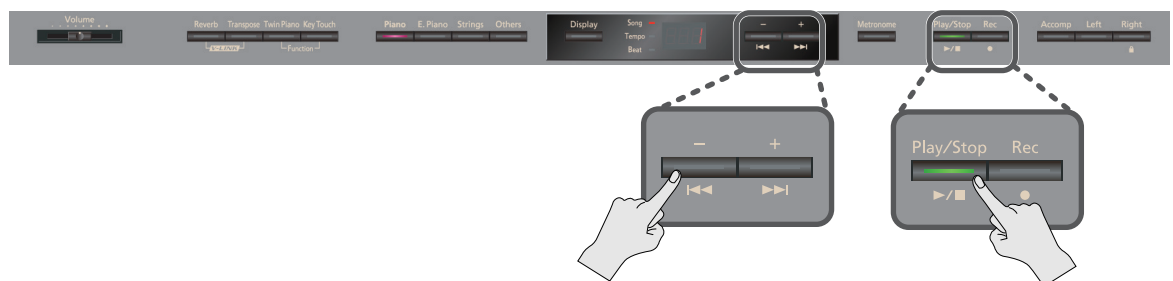

1. **Hold down the [▶/■] button and press the [-] or [+] button.**

The volume of song playback is shown while you hold down the [▶/■] button.

<b>Song volume range</b>	0-10
--------------------------	------

10

\* The song playback volume is reset to "10" when you turn off the power.

## Changing the Song's Tempo

You can change the tempo at which a song plays back.

When you're practicing along with an internal song, this allows you to slow down the tempo of a difficult song in order to play it more comfortably.

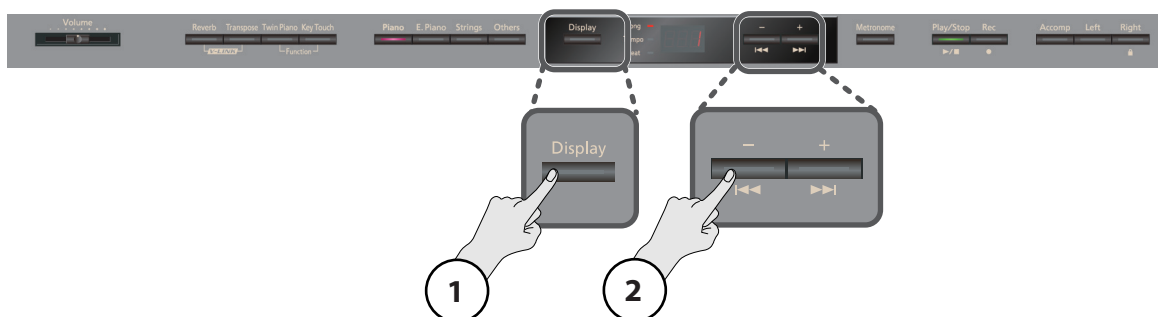

1. **Press the [Display] button a number of times so the Tempo indicator will light.**

The Tempo indicator will light.

2. **Press the [-] or [+] button.**

The tempo will change.

**MEMO**

If desired, you can make the song play back at a fixed tempo without allowing its tempo to change (p. 60).



## Changing the Pitch of the Song (Playback Transpose)

You can change the key of a song's playback. This is called the "Playback Transpose" function.

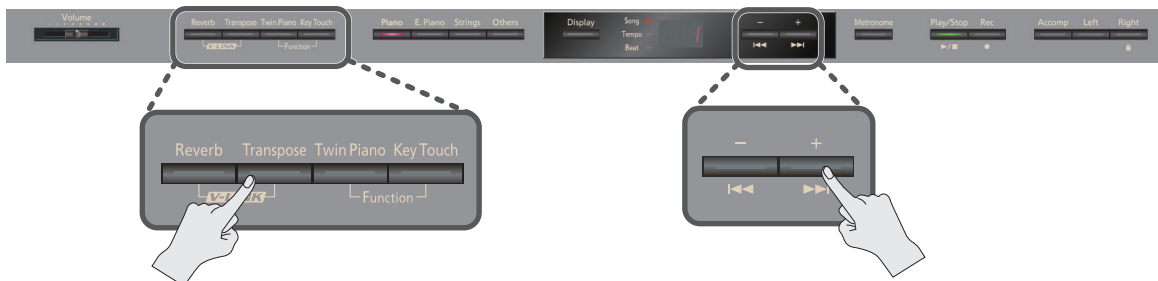

1. **Play back the song (p. 39).**
2. **Hold down the [Transpose] button and press the [-] or [+] button.**

The song's key will change in semitone steps.

<b>Transposition range</b>	-6-0-5 (semitone units)
----------------------------	-------------------------

While you hold down the [Transpose] button, the Playback Transpose setting is displayed.

If the value is anything other than 0, the [Transpose] button will be lit.

The transposition setting will return to "0" when you select a different song.

**MEMO**

If you hold down the [Transpose] button and press both of the [-] [+] buttons simultaneously, the setting will return to its original value (0).

**MEMO**

You can use the [Transpose] button to turn the Playback Transpose function on/off (if the transposition setting is other than "0").

**MEMO**

The HP305/HP302 allows you to transpose both the keyboard and the song, or just the keyboard, or just the song (p. 57). With the factory settings, the keyboard and the song will be transposed together.

\* The Playback Transpose function will not apply if "Transpose Mode" (p. 57) is set to "Kbd (Keyboard notes)."







# Recording Your Performance

## Recording Your Keyboard Performance

It's easy to record your own performances.

You can play back a recorded performance to check your playing, or perform along with a recorded performance.

### Getting ready to record

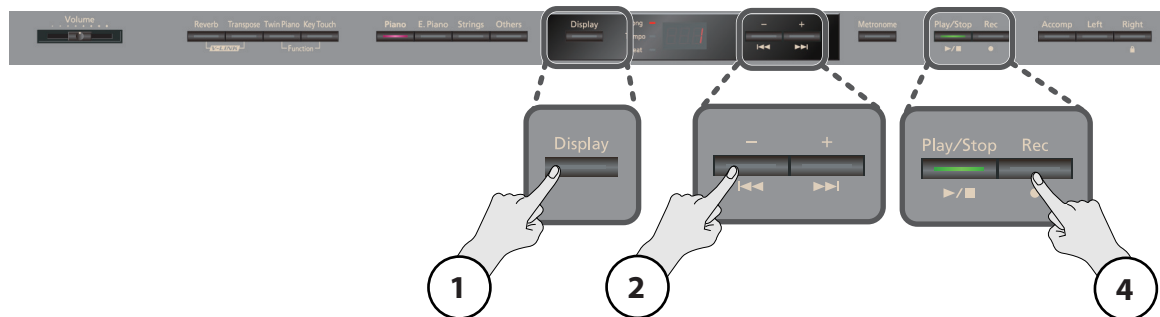

1. Press the [Display] button a number of times so the Song indicator will light.

2. Press the [-] button a number of times so the display will indicate "USr."



3. Select the tone that you want to use for performing (p. 25).

If desired, sound the metronome (p. 26).

4. Press the [●] button.

The [●] button will light, the [▶/■] button will blink, and the HP305/HP302 will enter recording-standby mode.

If you decide not to record, press the [●] button once again.

### Starting/stopping recording



1. Press the [▶/■] button or play the keyboard.

A two-measure count will be heard (the measure number will be shown as "-2" then "-1" in the display), and then recording will start.

When recording starts, the [●] button and [▶/■] button will light.

**MEMO**

A count sound will not sound if you initiated recording by playing the keyboard.

2. Press the [▶/■] button.

Recording will stop.

## Listening to the recorded performance

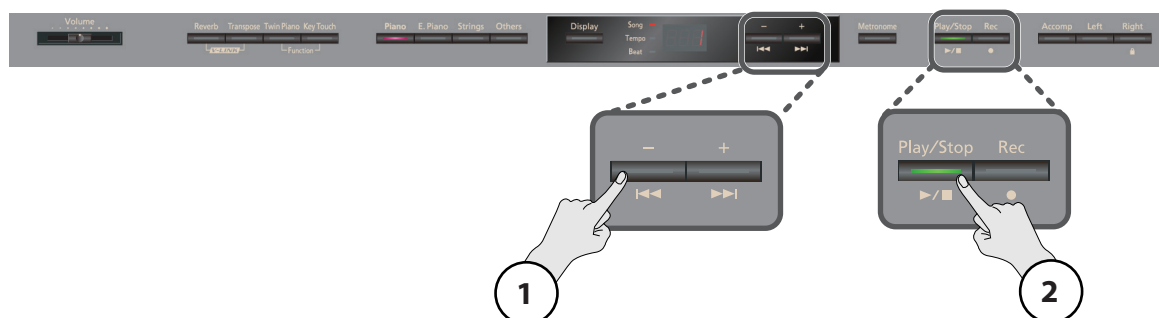

### 1. Press the [ |◀◀ ] button.

You will return to the beginning of the recorded performance.

### 2. Press the [ ▶/■ ] button.

The recorded performance will play.

Playback will stop when you press the [ ▶/■ ] button once again.

#### MEMO

If you press the [ ▶/■ ] button while the metronome is sounding, there will be a two-measure count (count-in) before playback begins.

#### NOTE

The recorded performance will be lost when you turn off the power. If you want to keep your recorded performance, you must save it to internal memory (p. 46) or to USB memory (p. 66).

#### NOTE

You won't be able to play back another song if there is an unsaved performance. You'll need to either delete (p. 45) or save (p. 46) your performance before playing another song.

### If the following indication appears

The confirmation message shown at right will appear if you attempt to select another song while the previously recorded song has not yet been saved.

Please save your recorded performance to internal memory (p. 46) or USB memory (p. 66).

- If you decide to erase your recorded performance, press the [ ● ] button.
- If you don't want to erase your recorded performance, press the [ ▶/■ ] button.



## Erasing Your Recorded Performance

Here's how to erase your recorded performance.

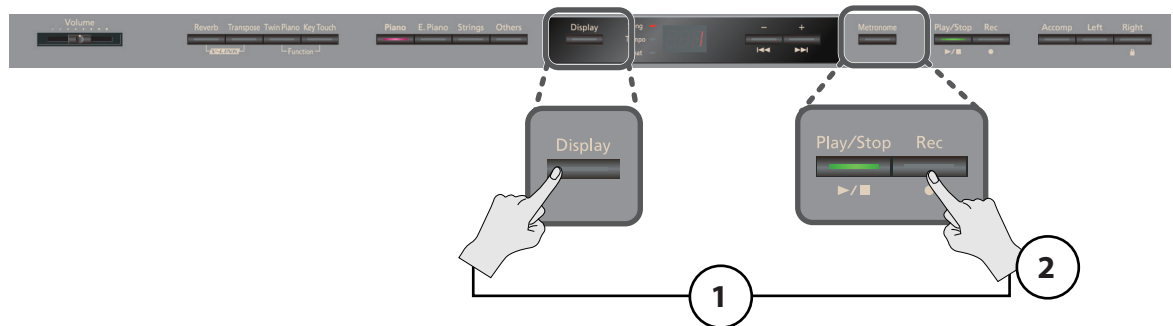

**1. Hold down the [Display] button and press the [ ● ] button.**

A confirmation message will appear and the [ ▶/■ ] button and [ ● ] button will blink. If you decide not to erase the performance, press the [ ▶/■ ] button.



**2. Press the [ ● ] button.**

The recorded performance will be erased.

**MEMO**

If you hold down the [ ● ] button while pressing a track button, the performance of only that track will be erased.

**NOTE**

A recorded performance will be erased when you turn off the power.

## Saving Your Recorded Performance

If you've recorded a performance, your recorded performance will be lost if you turn off the HP305/HP302's power before saving the song. If you want to keep your recorded performance, it is convenient to save it in internal memory. Songs saved in internal memory will not be lost when you turn off the power.

**MEMO** You can also save your recorded performances on USB memory (sold separately) or on a floppy disk (sold separately) (p. 66).

**MEMO** If you want to save a song from internal (external) memory to external (internal) memory, select the song that you want to save.

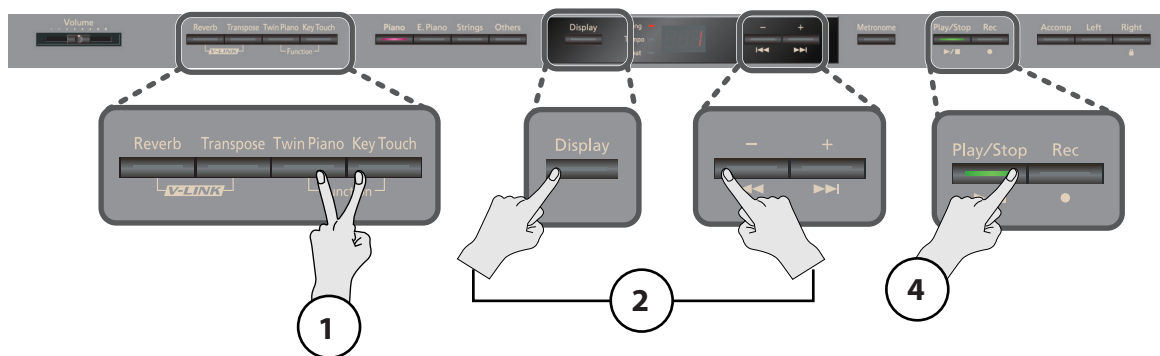

### Getting ready to save

1. Hold down the [Twin Piano] button and press the [Key Touch] button.

The display will indicate "Fnc," and you'll be in Function mode (p. 55).



2. Hold down the [Display] button and use the [-] buttons to make the display indicate "SAv."



3. When you take your finger off the [Display] button, the display will indicate "Int."

If [Int] is not displayed, press the [-] button.



4. Press the [▶/■] button.

The screen will allow you to select the save-destination number.



## Selecting the save destination for the song

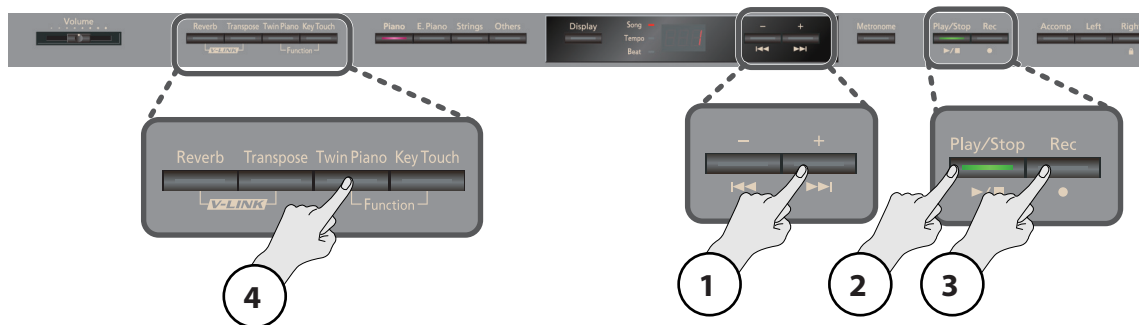

### 1. Press the [-] or [+] button to select the save destination.

If the dot in the lower right of the display is lit, a song has already been saved in that number.

Select a number at which no song has been saved.

If you want to erase an unwanted song and replace it with the newly saved song, select the number of the unwanted song.



Lit if a song  
has been saved

### 2. Press the [▶/■] button.

The display will indicate "Sur," and the [▶/■] button and [●] button will blink.

If you decide not to save the song, press the [▶/■] button.



### 3. Press the [●] button.

The song will be saved.

#### NOTE

Never turn off the power while the screen indicates "SAV."



### 4. Press the [Twin Piano] button or the [Key Touch] button.

You will exit Function mode.

- \* You can't select another song if the recorded performance has not yet been saved. Either erase your recorded performance, or save it (p. 44).

## Deleting a Saved Song

Here's how to delete a song that you saved to internal memory.

**MEMO**

If you want to delete all the songs that are saved in internal memory, initialize the memory (p. 63).

**MEMO**

You can also delete songs from USB memory (sold separately) or a floppy disk (sold separately) (p. 66).

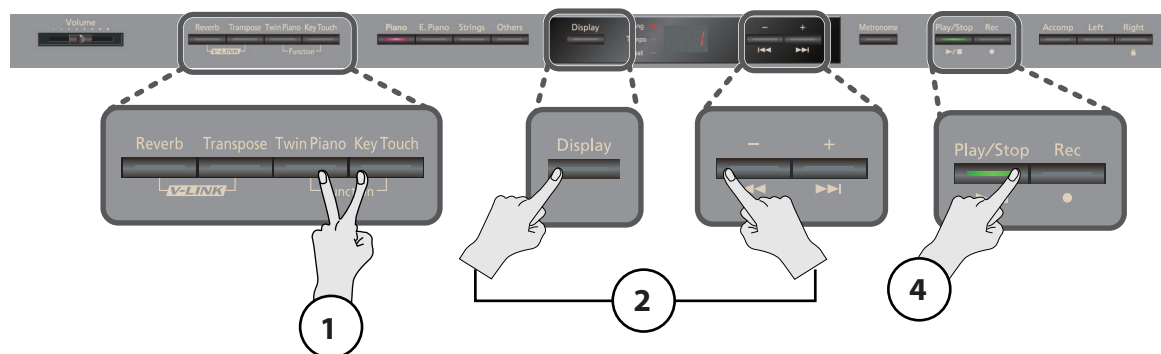

### Getting ready to delete

1. **Hold down the [Twin Piano] button and press the [Key Touch] button.**

The display will indicate "Fnc," and you'll be in Function mode (p. 55).

Fnc

2. **Hold down the [Display] button and use the [-] button to make the display indicate "dEL."**

dEL

3. **When you take your finger off the [Display] button, the display will indicate "Int."**

If [Int] is not displayed, press the [-] button.

Int

4. **Press the [▶/■] button.**

The screen will allow you to select the song number to be deleted.

001

## Choosing the song to delete

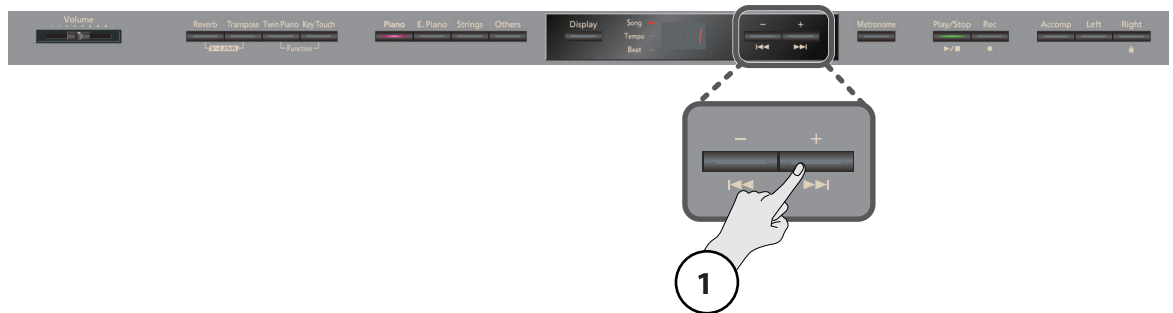

1. Press the [-] or [+] button to select the song that you want to delete.



## Deleting the song

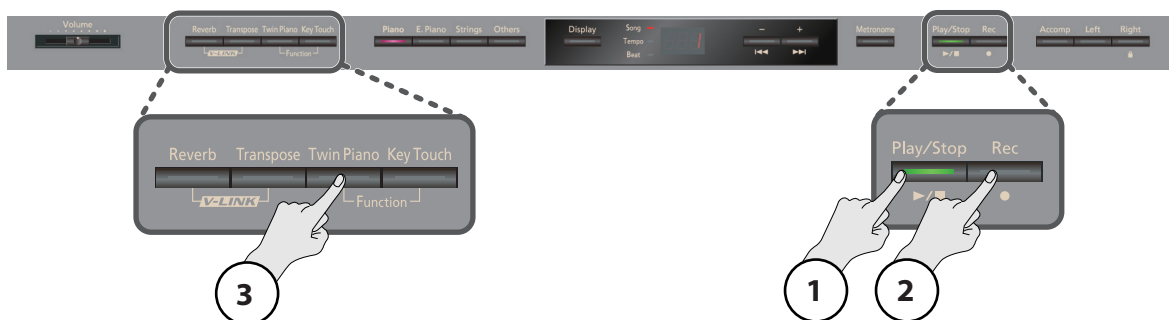

1. Press the [▶/■] button.  
The display will indicate "Sur," and the [▶/■] button and [●] button will blink.  
If you decide not to delete the song, press the [▶/■] button.
2. Press the [●] button.  
The selected song will be deleted.
3. Press the [Twin Piano] button or the [Key Touch] button.  
You will exit Function mode.



### NOTE

Never turn off the power while the screen indicates "dEL."



## Advanced Recording Methods

### Recording Each Hand Separately

You can separately record your left-hand performance to the [Left] button and your right-hand performance to the [Right] button. You can also separately re-record each hand afterward.

#### Getting ready to record

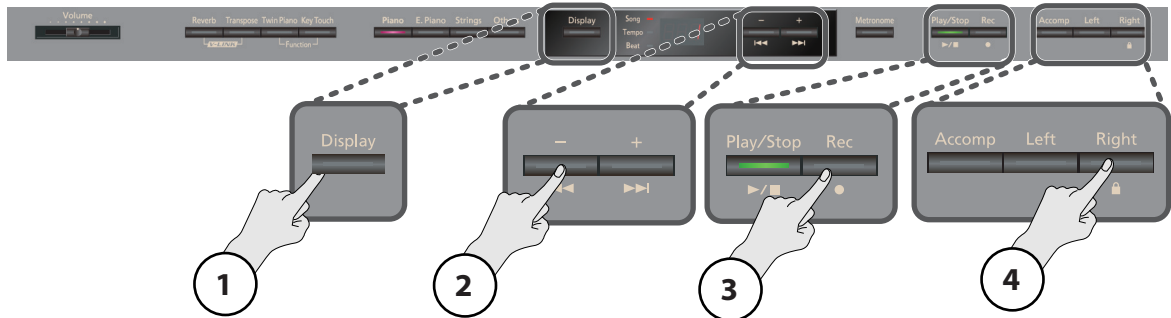

1. Press the [Display] button a number of times so the song indicator is lit.

The display will indicate the song number.



2. Press the [-] button a number of times so the display will indicate "USr."



3. Press the [●] button.

The [●] button will light, the [▶/■] button and the button of the track to be recorded will blink, and the HP305/HP302 will enter recording-standby mode.

If you decide not to record, press the [●] button once again.

4. Press the button for any track that you don't want to record, so it's not lit.

**MEMO**

Your performance can be recorded separately to the relevant track buttons.

#### Recorded performances and the track buttons

The performances you record are assigned to the track buttons as follows.

##### Conventional performance (using the entire keyboard to play a single tone), Dual play

Track button	Recorded performance
Record with only a single button specified	Your performance will be recorded on the specified track.
Record with multiple buttons specified	Your performance will be recorded on only one track The priority order for recording will be: [Right] button → [Left] button → [Accomp] button.

##### Twin Piano (p. 32), Split Play (p. 34)

Track button	Recorded performance	
	Twin Piano	Split Play
[Right] button	Right	Right-hand tone
[Left] button	Left	Left-hand tone



## Recording and stopping

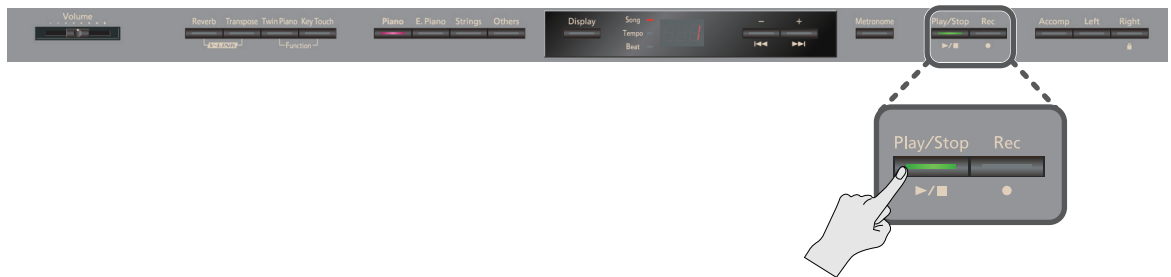

### 1. Press the [ ▶/■ ] button.

You'll hear a two-measure count, and then recording will begin.

Alternatively, you can start recording by playing the keyboard instead of pressing the [ ▶/■ ] button. In this case, there will be no count-in.

When recording begins, the [ ● ] button and [ ▶/■ ] button will light.

#### MEMO

During the count, "-2" then "-1" will be shown as the measure number in the screen.

### 2. To stop recording, press the [ ▶/■ ] button.

## Additional recording

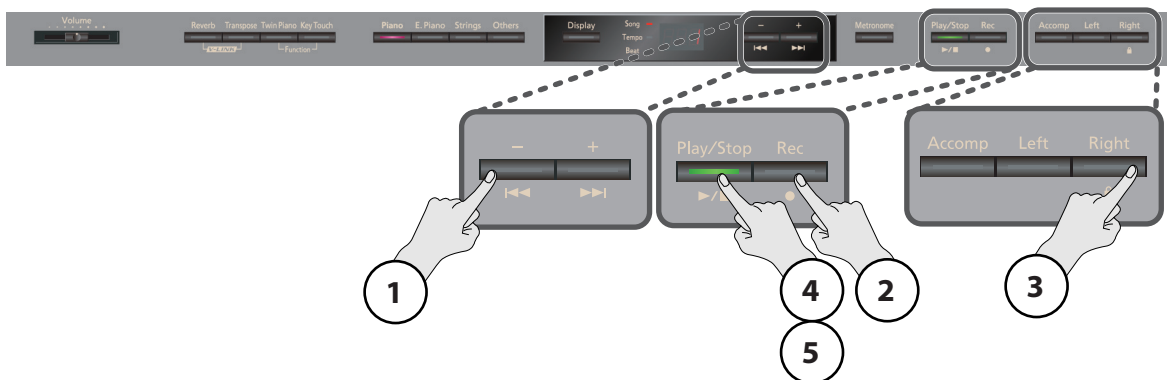

### 1. Press the [ ▶/■ ] button.

You'll return to the beginning of the recorded performance.

### 2. Press the [ ● ] button.

The [ ● ] button will light, the [ ▶/■ ] button and the button of the track to be recorded will blink, and the HP305/HP302 will enter recording-standby mode.

If you decide not to record, press the [ ● ] button once again.

### 3. Press the button of the track that you want to record, so it's blinking.

If you decide not to record, press the [ ● ] button once again.

#### NOTE

If you select a previously recorded track for recording, your new performance will be overwritten onto that track, erasing the previously recorded performance.

#### 4. Press the [ ▶/■ ] button.

You'll hear a two-measure count, and then recording will begin.

Alternatively, you can start recording by playing the keyboard instead of pressing the [ ▶/■ ] button. In this case, there will be no count-in.

When recording begins, the [ ● ] button and [ ▶/■ ] button will light.

##### MEMO

During the count, "-2" then "-1" will be shown as the measure number in the screen.

- \* If you record additional material without erasing the previously recorded performance, the song's tempo and time signature will remain as they were when first recorded.

#### 5. To stop recording, press the [ ▶/■ ] button.

##### When you re-record

If you re-record from the beginning, the previously recorded performance will be erased as the new recording proceeds.

If you want to record an entire performance, erase the previously recorded performance first (p. 46).

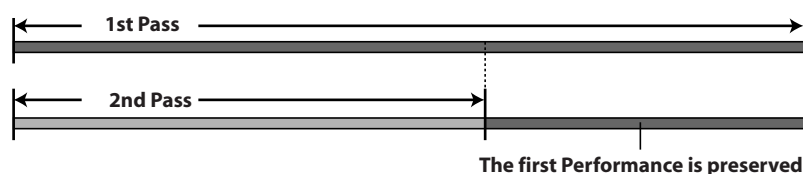

### Listening to the recorded performance

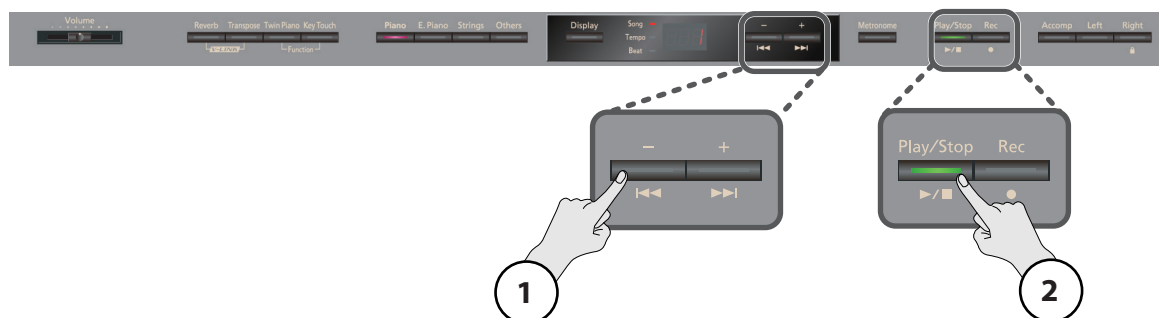

#### 1. Press the [ <<< ] button.

You'll return to the beginning of the recorded performance.

#### 2. Press the [ ▶/■ ] button.

The recorded performance will play back.

Press the [ ▶/■ ] button once again to stop playback.

##### NOTE

Your recorded performance will be lost when you turn off the power. If you want to keep your recorded performance, you must save it to internal memory (p. 46) or USB memory (p. 66).

##### MEMO

You can't play back another song if a recorded performance exists. Erase or save your recorded performance, and then play back the desired song (p. 44).

##### MEMO

By holding down one of the track buttons and pressing the [ ● ] button, you can erase the performance of just that track. If you erase the performance from all tracks, the display will indicate "USr."

## Recording a Performance You Play Along with a Song

Here's how you can record a performance that you play along with an internal song or a song from internal memory.

The part you select using the track buttons will be recorded, replacing the previous content of that part.

During recording, you won't hear the sound of the track whose button you selected.

- \* You can't record along with a song from a music CD, or with a song that consists of audio data.

### Getting ready to perform

**1. Select the song that you want to play back (p. 39).**

**2. Select the tone that you want perform (p. 25).**

**3. Specify the tempo for recording (p. 26).**

- \* The tempo of your recorded performance will be the tempo of the song you selected for recording.  
When you record a performance that you play along with a song, it will be recorded with the time signature of that song.

### Getting ready to record



**1. Press the [ ● ] button.**

The [ ● ] button will light, the [ ►/■ ] button will blink, and the HP305/HP302 will enter recording-standby mode. If you decide to cancel recording, press the [ ● ] button once again.

**2. Press the track button of the part that you want to record, so it's blinking.**

With this setting, you will be listening to the selected song while you record.

#### Recorded performances and the track buttons

The performances you record are assigned to the track buttons as follows.

Track button	Performance part
[Right] button	Right-hand part
[Left] button	Left-hand part
[Accomp] button	Other performances

## Recording and stopping

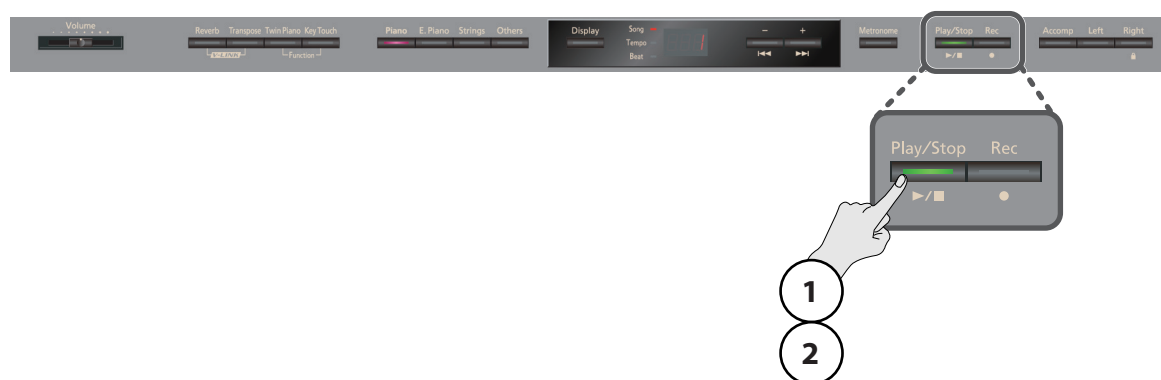

### 1. Press the [ ▶/■ ] button.

You'll hear a two-measure count, and then recording will begin.

Alternatively, you can start recording by playing the keyboard instead of pressing the [ ▶/■ ] button. In this case, there will be no count-in.

When recording begins, the [ ● ] button and [ ▶/■ ] button will light.

#### MEMO

During the count, "-2" then "-1" will be shown as the measure number in the screen.

### 2. Press the [ ▶/■ ] button.

Recording will stop.

## Listening to the recorded performance

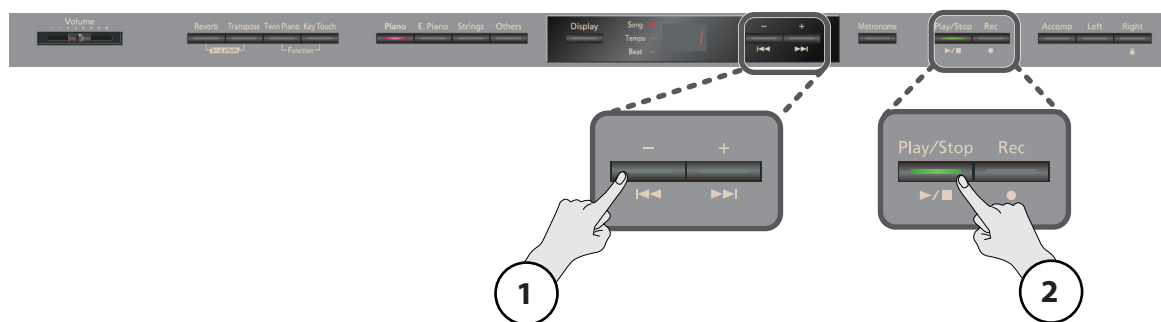

### 1. Press the [ |◀◀ ] button.

You'll return to the beginning of the recorded performance.

### 2. Press the [ ▶/■ ] button.

The recorded performance will play back.

Press the [ ▶/■ ] button once again to stop playback.

#### MEMO

Your recorded performance will be lost when you turn off the power. If you don't want to lose your recorded performance, you must save it to internal memory (p. 46) or to USB memory (p. 66).

#### MEMO

You can't play back another song if a recorded performance exists. Erase or save your recorded performance, and then play back the desired song (p. 44).

# Various Settings

## Basic Operation in Function Mode

“Function mode” lets you make various settings for playback and recording.

### Entering Function mode



#### 1. Hold down the [Twin Piano] button and press the [Key Touch] button.

The [Twin Piano] button and [Key Touch] button will light. The display will indicate “Fnc” and you’ll be in Function mode.



### Selecting the setting that you want to edit



#### 1. While holding down one of the blinking buttons, press the [-] or [+] button to select the setting that you want to edit.

The name of the setting is shown in the display while you hold down the button. When you release the button, the value of the setting will be shown.

## Editing a setting

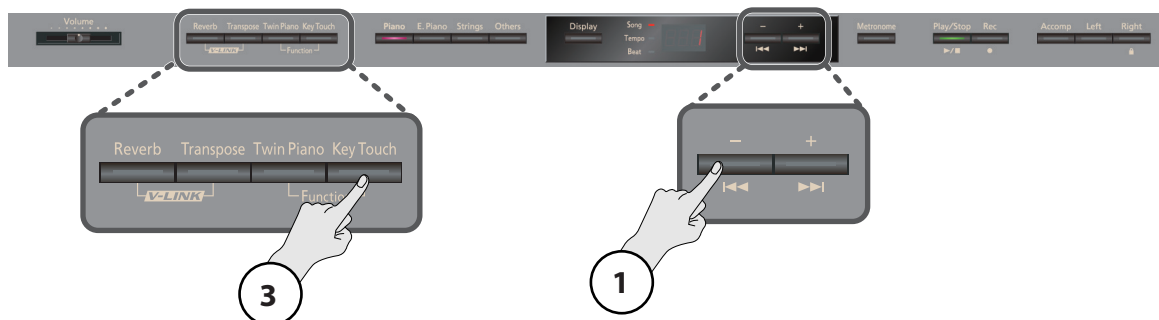

1. **Press the [-] or [+] button to edit the setting.**  
By pressing the [-] [+] buttons simultaneously you can return the setting to its factory-set value.
2. **If you wish to change other settings, refer to step 1 under “Selecting the setting that you want to edit,” and select the setting you want to change.**
3. **Press the [Twin Piano] button or the [Key Touch] button to exit Function mode.**  
The button indicators will return to their previous state.

**MEMO**

The edited settings will revert to their original value when you turn off the power. For some settings, you can specify that they retain their edited state even when you turn off the power (p. 61).  
For details on the settings that can be saved in this way, refer to “Parameters Stored in Memory Backup” (p. 82).

## Selecting the setting that you want to edit

Button	Function	Page
Reverb	Brilliance brL	p. 57
	Transpose Mode trS	p. 57
Transpose	Octave Shift Oct	p. 57
	Dual Balance dbl	p. 58
	Master Tuning tun	p. 58
Piano	Stretch Tuning str	p. 58
	Temperament tnP	p. 58
	Temperament Key tNE	p. 58

Button	Function	Page
E. Piano	Damper Resonance rES	p. 59
	String Resonance rSt	p. 59
	Key Off Resonance rOF	p. 59
Strings	Damper Pedal Part dPr	p. 59
	Center Pedal Function cPd	p. 59
	Left Pedal Function lPd	p. 59

Button	Function	Page
Others	Tempo Mute 	p. 60
	Local Control 	p. 71
	MIDI Transmit Channel 	p. 71
	Composer MIDI Out 	p. 71
	V-LINK Transmit Channel 	p. 73
	Track Assign 	p. 60
	Recommended Tone 	p. 65
	Mute Volume 	p. 60
	CD/Audio Type 	p. 60
	Display	Save a Song 
Deleting a Song 		p. 48
Initializing the Memory 		p. 63
Accomp	USB Driver 	p. 72
	External Memory Mode 	p. 63
Left	Memory Backup 	p. 61
Right	Factory Reset 	p. 61

## Sounds Settings

### Adjusting the Sound's Brilliance (Brilliance)

Here's how to adjust the brilliance of your keyboard playing or the playback brilliance of an internal song or USB memory song. Increasing the value will make the sound brighter.

Setting
-10 (Mellow)–10 (Bright)

## Performing Settings

### Specifying What the Key Transpose will Affect (Transpose Mode)

This setting specifies what the key transpose will affect. You can use the key transpose to change the pitch of both the song and the keyboard, the pitch of only the song, or the pitch of only the keyboard.

Setting	Description
	Keyboard notes Transpose (p. 37)
	Song playback Playback Transpose (p. 42)
	Keyboard notes and song playback

### Changing the Pitch of the Tone in Octave Steps (Octave Shift)

You can change the pitch of the Tone 2 in Dual play (p. 31) and Lower tone in Split play (p. 34) an octave at a time. Altering the pitch in one-octave units in this way is called "Octave Shift." For example, you can raise the pitch of the Lower Tone to the same pitch of the Upper Tone in Split play.

Setting
-2 – 0 – +2

## Adjusting the Dual Play Volume Balance (Dual Balance)

You can adjust the volume balance between the two tones (tone 1 and tone 2) used for Dual play.

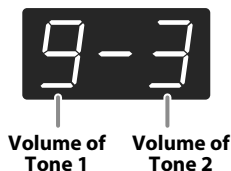

Setting
9-1 (tone 1 is louder)-9-9 (same volume)-1-9 (tone 2 is louder)

## Tuning Settings

### Matching the Pitch with Other Instruments (Master Tuning)

When playing ensemble with other instruments and in other such instances, you can match the standard pitch to another instrument. The standard pitch generally refers to the pitch of the note that's played when you finger the middle A key. For a cleaner ensemble sound while performing with one or more other instruments, ensure that each instrument's standard pitch is in tune with that of the other instruments. This tuning of all the instruments to a standard pitch is called "Tuning."

Setting	Master tuning value
15.3-40.0-66.2	415.3 Hz - 440.0 Hz - 466.2 Hz

**MEMO**

When the instrument is shipped from the factory, this is set to "440.0 Hz."

### Using a Piano's Unique Tuning (Stretch Tuning)

Pianos are generally tuned so that the low range is flatter and the high range is sharper than equal tempered pitches. This method of tuning is unique to the piano, and is known as "stretched tuning."

Setting	Description
On	This tuning curve expands the bass and treble ends somewhat. It is suitable for performances such as piano solos.
OFF	This is the standard tuning curve. This is suitable for when using Dual play (p. 31) or when playing in an ensemble with other instruments.

## Adjusting the Tuning (Temperament)

You can play classical music such as baroque pieces using their original tuning.

Most modern songs are composed and played with the assumption that equal temperament (the most common tuning in use today) will be used, but when classical music was composed, there were a wide variety of other tuning systems in existence. Playing a composition with its original tuning lets you enjoy the sonorities of the chords that the composer originally intended.



Temperament    Temperament key

Setting	Temperament	Qualities
1	Equal	In this tuning, each octave is divided into twelve equal steps. Every interval produces about the same amount of slight dissonance.
2	Just (Major)	This tuning eliminates ambiguities in the fifths and thirds. It is unsuited to playing melodies and cannot be transposed, but is capable of beautiful sonorities.
3	Just (Minor)	The Just tunings differ from major and minor keys. You can get the same effect with the minor scale as with the major scale.
4	Arabic	This tuning is suitable for the music of Arabia.
5	Kirnberger	This is an improvement of the Meantone and Just tunings that provides a high degree of freedom of modulation. Performances are possible in all keys (III).
6	Meantone	This scale makes some compromises in just intonation, enabling transposition to other keys.
7	Pythagorean	This tuning, devised by the philosopher Pythagoras, eliminates dissonance in fourths and fifths. Dissonance is produced by third-interval chords, but melodies are euphonious.
8	Werckmeister	This temperament combines the Meantone and Pythagorean tunings. Performances are possible in all keys (first technique, III).

### Specifying the Temperament Key

When playing with tuning other than equal temperament, you need to specify the temperament key for tuning the song to be performed (that is, the note that corresponds to C for a major key or to A for a minor key). If you choose an equal temperament, there's no need to select a temperament key.



Temperament    Temperament key

Display	C	C <sup>-</sup>	d	E <sub>-</sub>	E	F	F <sup>-</sup>	G	A <sub>-</sub>	A	b <sub>-</sub>	b
Key	C	C <sup>#</sup>	D	E <sub>b</sub>	E	F	F <sup>#</sup>	G	A <sub>b</sub>	A	B <sub>b</sub>	B

\* When performing in ensemble with other instruments, be aware that depending on the key, there may be some shifting of the pitch. Tune the HP305/HP302 to the fundamental pitch of the other instruments.



## Piano Sound Settings

### Producing Sympathetic Resonance When You Press the Damper Pedal (Damper Resonance)

You can change the volume of the damper pedal resonance. On an acoustic piano, depressing the damper pedal makes the notes you play resonate with other strings, adding rich reverberations and fatness to the sound. The damper pedal on the HP302/HP305 recreates this resonance (Damper Resonance) when depressed.

Setting	Description
OFF, 1-10	The resonance volume decreases as the value is lowered, while raising the value increases the volume of the Damper Resonance. The Damper Resonance function is not active when the value is set to "OFF."

### Producing the Resonance of the Strings When the Keys Are Played (String Resonance)

When you play the keys on an acoustic piano, the strings that are already playing resonate as well. The function that reproduces this effect is called "String Resonance."

Setting	Description
OFF, 1-10	The resonance level decreases as the value is decreased, while increasing the value increases the amount of resonance. The String Resonance function is not active when the value is set to "OFF."

### Playing Sounds When the Keys Are Released (Key Off Resonance)



You can play the "key off" sound (the subtle sound produced when the keys are released) obtained when playing an acoustic piano.

Setting	Description
OFF, 1-10	The volume of the Key Off sound decreases as the value is lowered, while raising the value increases the volume of the Key Off sound. The Key Off Resonance function is not active when the value is set to "OFF."

## Pedal Settings





### Changing How the Pedal Effects Are Applied (Damper Pedal Part)

When you press the Damper pedal during Dual play or Split play, the pedal effect is normally applied to both tones, but you can also select the part to which the effect is to be applied.

Setting	Description
Right & Left 	All enabled
Right 	Applied only to the Tone 1 (in dual mode)/Right-hand Tone (in split mode)
Left 	Applied only to the Tone 2 (in dual mode)/Left-hand Tone (in split mode)

### Changing How the Pedals Work (Center/Left Pedal Function)

When you turn on the power, the left pedal functions as the soft pedal, and the center pedal functions as the sostenuto pedal (p. 22). You can change the function of the pedal to a variety of other operations.

Function	Description
Sostenuto 	Sets function to Sostenuto pedal. * Selectable only for the center pedal.
Soft pedal 	Sets function to soft pedal. * Selectable only for the left pedal.
Start/stop 	The pedal will have the same function as the [▶/■] button.
Layer 	Pressing the pedal will layer on Tone 2, used for Dual play. * The Layer function can be applied only when using Dual play.
Octave 	Pressing the pedal will layer on a sound one octave higher. * The Octave function cannot be applied while using Twin Piano, Dual play, or Split play.

\* "Lyr (Layer)" and "Oct (Octave)" cannot be specified simultaneously for the center and left pedals.

## Other Settings

### Playing Back at a Fixed Tempo (Tempo Mute)

Some of the internal songs have a tempo that varies during the song.

If desired, you can make these songs play at a fixed tempo.

Setting	Description
On	Tempo changes recorded in the song will be ignored, and the song will play at a fixed tempo.
OFF	The song will play according to the tempo changes it contains.

If Tempo Mute is turned on, the tempo indication in the screen will be highlighted.



Lit if Tempo Mute is enabled

### Changing the Parts Assigned to the Track Buttons During SMF Playback (Track Assign)

Ordinarily, when playing back SMF music files for Roland Piano Digital instruments (p. 83), the left-hand part is assigned to the [Left] button, and the right-hand part is assigned to the [Right] button. However, right-hand and left-hand part assignments in certain SMF music files may differ.

If these are set to "Auto," and as a result you are unable to use the track buttons to control the left- and right-hand parts properly, change the setting to "2/1 Part" or "3/4 Part."

\* This setting can be used for SMF format songs other than the internal preset songs. It will not affect internal preset songs.

Setting	Description
	The part assigned to each track will be determined automatically, depending on the song file.
	Assigns Part 1 to the [Right] button, Part 2 to the [Left] button, and the remaining parts to the [Accomp] button.
	Assigns Part 4 to the [Right] button, Part 3 to the [Left] button, and the remaining parts to the [Accomp] button.

**MEMO**

After changing this setting, try selecting the song once again.

### Using the Sound of a Specific Part as a "Guide" (Mute Volume)

If desired, you can specify that the sound of a track will play at a reduced volume rather than going completely silent when you press a track button and turn off its indicator.

This setting lets you play a specific part at a reduced volume and use it as a "guide" for your playing.

Setting	Description
0 - 10	Increasing the value will make the sound louder.

When you turn off the power, the track mute volume will be reset to "0."

### Setting the Type of CD To be Played Back (CD/Audio Type)

The HP305/HP302 may be unable to correctly recognize the type of CD being used. In such instances, you can specify the type of CD manually.

Setting	Description
Auto 	The CD type is detected automatically
Type A 	General CDs for Player Piano contain audio and MIDI data, and the data format may vary from one CD to the next. If the CD's data format does not match the HP305/HP302's settings, a "beep" will sound. Certain general Piano player CDs may not be playable on the HP305/HP302.
Type B 	
Stereo 	Commercial Audio CD (CDs other than those designed for use with the player piano)

\* Note that some commercial player piano CDs cannot be played back on the HP305/HP302.

## Storing Your Settings (Memory Backup)

The settings you edit in Function mode will return to their factory-set values when you turn off the power, but the "Memory Backup" function lets you store these settings so that they will not change even when you turn off the power.

### 1. Enter Function mode, choose "buP" (p. 55).



### 2. To save the settings, press the [ ▶/■ ] button.

A confirmation message will appear.



If you decide to cancel, press the [ ▶/■ ] button.

### 3. To execute the operation, press the [ ● ] button.

When the memory backup has been completed, the display will indicate "Fnc."



#### NOTE

Never turn off the power while the settings are being saved.

#### MEMO

For details on the items that are saved, refer to "Parameters Stored in Memory Backup" (p. 82).

## Restoring the Factory Settings (Factory Reset)

When you execute the "Factory Reset" function, the settings you've edited in Function mode will be restored to their factory-set state. Execute this function when you want the settings you saved using the Memory Backup function to be restored to the state they were in when you purchased the HP305/HP302.

#### NOTE

When you execute "Factory Reset," all stored settings will be erased and returned to the factory settings.

#### MEMO

This function will not erase the songs from internal memory or external memory such as separately sold USB memory.

If you want to erase internal memory or external memory such as USB memory, refer to "Initializing the Memory" (p. 63).

### 1. Enter Function mode, choose "Fct" (p. 55).



### 2. To execute Factory Reset, press the [ ▶/■ ] button.

A confirmation message will appear.



If you decide to cancel, press the [ ▶/■ ] button.

### 3. If you're sure you want to execute, press the [ ● ] button.

The factory reset will be executed.

When the Factory Reset has been completed, the following display will appear.



#### NOTE

Never turn off the power while the Factory Reset is being executed.

### 4. Turn the power off, and then on again (p. 21).

# Connecting to Other Devices

## Connecting a Media

You will be able to accomplish the following once you've connected external media (CD drive, floppy disk drive, or USB memory).

Device	What you can do
CD drive	Play back music CDs, SMF music files, and songs from a VIMA CD-ROM (VIMA TUNES sold by Roland)
Floppy disk drive	Play back SMF music files, and save performance data
USB memory	Play back SMF music files, save performance data, and play back audio files

\* If you're using new USB memory, you'll need to initialize (format) it on the HP305/HP302. For details, refer to "Initializing the Memory" (p. 63).

### Installing the CD Drive

Attach the CD drive as shown the figure, using the mounting holes on the HP305/HP302's bottom panel.

\* For details on installation and connections, refer to the owner's manual of the CD drive.

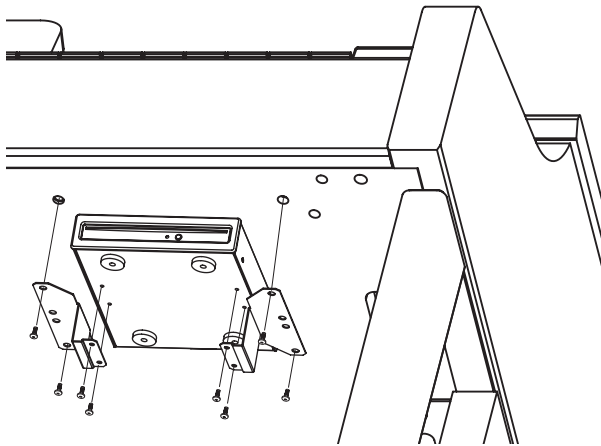

\* Use a CD drive sold by Roland. We cannot guarantee operation if any other CD drive is used.

#### Precautions Concerning Use of the CD

- You cannot play back CD-R/RW disks to which audio tracks have been added or CDs containing both audio tracks and data (CD Extra).
- The HP305/HP302 is capable of playing back only commercial CDs that conform the official standards—those that carry the "COMPACT DISC DIGITAL AUDIO" logo.
- The usability and sound quality of audio discs that incorporate copyright protection technology and other non-standard CDs cannot be guaranteed.
- For more detailed information on audio discs featuring copyright protection technology and other non-standard CDs, please consult the disc vendor.
- You cannot save songs and styles to CDs, and you cannot delete songs or styles recorded to CDs. Furthermore, you cannot format CDs.

### Installing the Floppy Disk Drive

Attach the floppy disk drive as shown the figure, using the mounting holes on the HP305/HP302's bottom panel.

\* For details on installation and connections, refer to the owner's manual of the floppy disk drive.

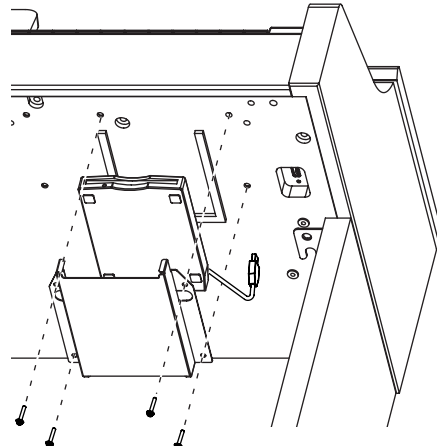

\* For the purposes of the explanation here, certain portions of the stand have been left out.

\* Use a floppy disk drive sold by Roland. We cannot guarantee operation if any other floppy disk drive is used.

### Connecting USB Memory

Connect the USB memory to the External Memory connector as shown the figure.

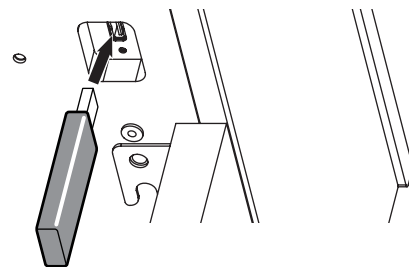

\* Carefully insert the USB Memory all the way in—until it is firmly in place.

\* Use a USB memory sold by Roland. We cannot guarantee operation if any other USB memory is used.

## Initializing the Memory

Here's how you can completely erase all songs that were saved in internal memory, USB memory (sold separately), or a floppy disk (sold separately).

### NOTE

Once an initialization is performed, all songs that have been saved in memory will be erased. The erased data cannot be recovered, so we recommend that you check the contents of memory before you proceed.

### NOTE

If you're using new USB memory (sold separately) or floppy disk with the HP305/HP302 for the first time, you'll need to initialize (format) the USB memory or floppy disk before using it. The HP305/HP302 can't use USB memory or floppy disk that has not been initialized.

If you want to initialize USB memory or a floppy disk, make the following preparations before you proceed.

- Connect your USB memory to the external memory connector.
- Connect your floppy disk drive to the external memory connector, and insert a disk in the drive.

### 1. Enter Function mode, choose "FMt."



### 2. Press the [-] or [+] button to select the memory that you want to initialize.

Setting	Description
Internal Memory 	Internal memory
External Memory 	USB memory, Floppy disk

### 3. Press the [▶/■] button.

A confirmation message will appear.



If you press the [▶/■] button, you'll return to the previous screen without initializing.

### 4. Press the [●] button.

Initialization will begin.

The entire contents of the selected memory will be erased.

Once the memory has been initialized, the following screen will appear.



### Caution when Initializing the Memory

- Never turn off the power while "FMt" is shown in the display.
- If the screen indicates "E," please refer to "Error Messages" (p. 77).
- Initializing the HP305/HP302's internal memory will not initialize settings other than the contents of internal memory. If you want to return settings other than the contents of internal memory to their factory-set condition, execute the Factory Reset operation (p. 61).
- Don't disconnect the USB memory until USB memory initialization has been completed.
- While a floppy disk is being initialized, do not eject the disk from the floppy disk drive or disconnect the cable of the disk drive.

## Changing the External Memory Setting (External Memory Mode)

In some cases, when USB memory is connected to the external memory connector, it may take longer for data to be loaded, or data may fail to be loaded successfully. If this occurs, you may be able to solve the problem by changing the external memory setting

### 1. Enter Function mode, choose "UMd."



### 2. Press the [-] or [+] button to edit the setting.

Setting	Description
	Mode1
	Mode2

### 3. If you change this setting, turn on the power once again.

#### MEMO

This setting is remembered even when the power is turned off.

## Playing Back Songs on External Media

You can play back songs from a CD, USB memory, or a floppy disk.

You can play back songs that are music data (p. 83) or audio files (p. 76).

**1. Prepare the external media that contains the song you want to play.**

Insert the floppy disk into the floppy disk drive, or the CD into the CD drive.

**2. Press the [Display] button a number of times so the Song indicator will light.**

**3. Select the song that you want to play back.**

Refer to "Selecting a song" below.

**4. Press the [▶/■] button.**

For details on operations during playback, refer to step 3 of "Playing Back Songs" (p. 39)

### Selecting a song

#### Button operations

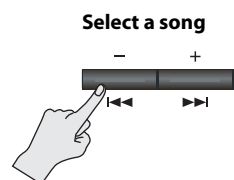

\* Press the [-] or [+] button to select a song.

#### Order in which memories are selected

The song to be newly recorded

Songs from CD, USB memory, or floppy disk

\* This cannot be selected if nothing is connected to the external memory connector.

Songs from internal memory

\* This cannot be selected if there are no songs.

Internal songs

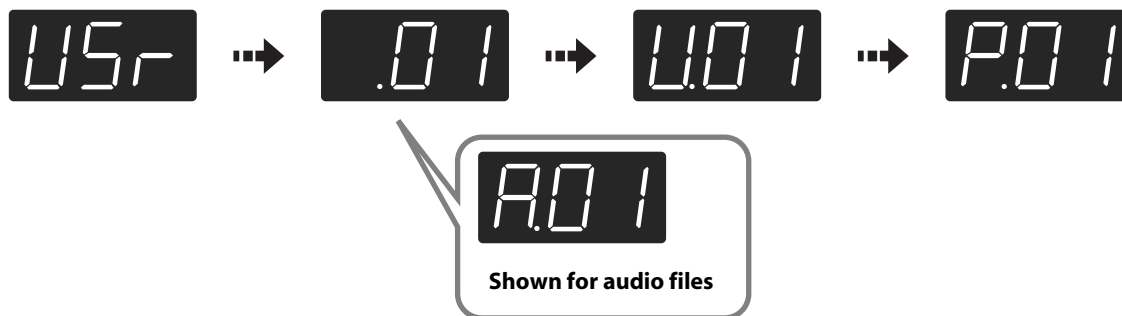

#### Select a song that's inside a folder

**1. Press the [Display] button a number of times so the "Song" indicator is lit.**



**2. Press the [-] button.**

If there are folders, they are indicated as shown at the right.



**3. Press the [▶/■] button.**

The first song in the folder will be selected.



If the folder contains no songs, or if the first song is selected when you press the [-] button, the right display will appear. Here you can press the [▶/■] button to exit the folder.



\* If a single folder contains more than 500 files or folders, some files or folders might not be displayed.

## Adjusting the Volume of an Audio File or Music CD

You can adjust only the volume of an audio file or music CD.

1. **Play back the audio file or music CD (p. 64).**
2. **Hold down the [▶/■] button and press the [-] or [+] button.**

Setting
0 – 10

## Changing the Tempo of an Audio File or Music CD

You can change the tempo of an audio file or a song from a music CD.

1. **Press the [Display] button a number of times so the “Song” and “Tempo” indicator is lit.**
2. **Press the [-] or [+] button.**

Setting
75 – 100 – 125 (%)

**MEMO** If you select a different song or turn off the power, the tempo will revert to a setting of “100.”

## Changing the Playback Pitch of a Song (Playback Transpose)

You can also change the playback pitch for a music CD song or an audio file (Playback Transpose; p. 42).

1. **Play back the audio file or music CD (p. 64).**
2. **While holding down the [Transpose] button, press the [-] or [+] button.**

Setting
-6 – 0 – 5 (semitone units)

\* If you've selected a music CD song or audio file, using Playback Transpose may affect the tonal character.

## Minimizing the Sounds in the Center (Center Cancel)

Sounds on a music CD or audio file that are heard from the center (typically the vocal or melody instrument) can be minimized in the playback.

1. **Play back the audio file or music CD (p. 64).**
2. **Press the [Right] button so its light is turned off.**

The volume of the melody or vocal will decrease.

\* For some songs, the sound heard from the center may not disappear completely.

**MEMO** To turn off the Center Cancel function, press the [Right] button. The Center Cancel function will also be turned off when you select a different song.

\* For some songs, using Center Cancel may affect the tonal character.

## Switching VIMA TUNES Recommended Tones (Recommended Tone)

You can connect a commercially available USB CD drive to the HP305/HP302, and play back separately sold CD-ROMs created for the VIMA (VIMA TUNES p. 83).

Songs on VIMA CD-ROM (VIMA TUNES) are programmed with “recommended tones” suitable for each song.

When you select a song from a VIMA CD-ROM (VIMA TUNES), recommended tones will be assigned to the HP305/HP302's [E. Piano], [Strings], and [Others] tone buttons, and these three tone buttons will blink. When you press a flashing Tone button, the recommended tone is then selected, enabling you to perform the selected song using a tone matched to that song as it plays back.

You can set the HP305/HP302 so that the recommended tones are automatically assigned or not assigned.

1. **Enter Function mode, choose “rtn” (p. 55).**



2. **Press the [-] or [+] button to switch “On” or “OFF.”**

Setting	Description
On	When you select a song from a VIMA CD-ROM (VIMA TUNES), recommended tones will automatically be assigned to the HP305/HP302's [E. Piano], [Strings], and [Others] tone buttons.
OFF	The recommended tones are not used, and only the HP305/HP302's internal tones can be selected.

This is set to “On” at the factory.

## Saving Your Recorded Performance on External Memory

Here's how to save your recorded performance to USB memory or a floppy disk.

### Getting ready to save

1. Enter Function mode, choose "SAV"(p. 55).



### Selecting the Save destination for the Song

1. Press the [-] or [+] button to choose "EXt" (external memory).

\* If there is no song to save, the following screen will not appear.



2. Press the [▶/■] button.

A screen in which you can select the save-destination number will appear



3. Press the [-] or [+] button to select the save destination.

Select a number at which no song has been saved.

If the dot in the lower right of the display is lit, a song has already been saved in that number.

If you want to erase an unwanted song and replace it with the newly saved song, select the number of the unwanted song.



### Saving the Song

1. Press the [▶/■] button.

The display will indicate "Sur."



If you decide not to save the song, press the [▶/■] button.

2. Press the [●] button.

The song will be saved.

**NOTE** Never turn off the power while the display indicates "SAV"



\* You can't select another song if the recorded performance has not been saved. Please save the recorded performance (p. 44).

## Deleting a Song from External Memory

Here's how to delete a song that you saved on USB memory or a floppy disk.

### Getting ready to delete

1. Enter Function mode, choose "dEL"(p. 55).



### Selecting the song to delete

1. Press the [-] or [+] button to choose "EXt" (external memory).

\* If there is no song to delete, the following screen will not appear.



2. Press the [▶/■] button.

A screen in which you can select the delete-destination number will appear



3. Press the [-] or [+] button to select the delete destination.

### Deleting the song

1. Press the [▶/■] button.

The display will indicate "Sur."



If you decide not to delete the song, press the [▶/■] button.

2. Press the [●] button.

The selected song will be deleted.

**NOTE** Never turn off the power while the display indicates "dEL."



\* You can't select another song if the recorded performance has not been saved. Please save the recorded performance (p. 44).



## Connecting to Audio Equipment

If you connect the HP305/HP302 to powered speakers or to an audio system that has line input jacks, you'll be able to hear the HP305/HP302's sound from your powered speakers or audio system. If you connect your digital audio player or other audio playback device to the HP305/HP302's, you'll be able to hear its sound via the HP305/HP302. Use audio cables (sold separately) to make connections.

### Caution when making audio connections

To prevent malfunction and/or damage to speakers or other devices, always turn down the volume, and turn off the power on all devices before making any connections.

When connection cables with resistors are used, the volume level of equipment connected to the inputs jacks may be low. If this happens, use connection cables that do not contain resistors.

### Having Audio from an External Device be Sounded Through the HP305/HP302.

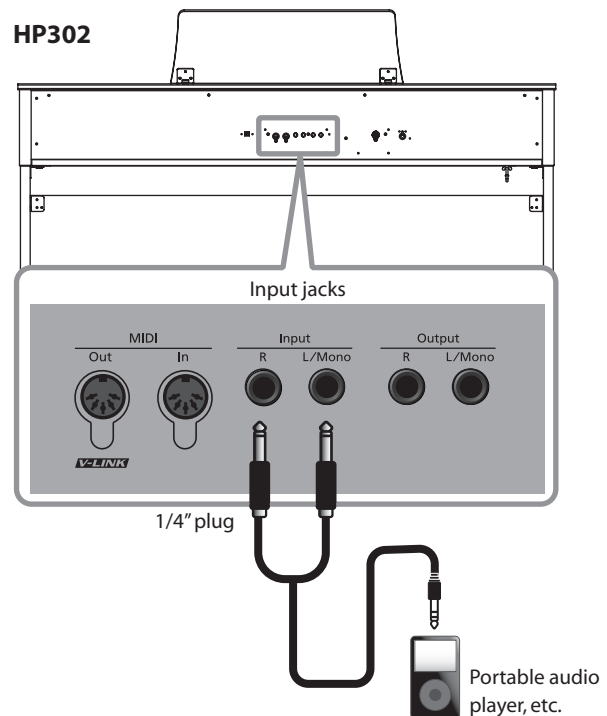
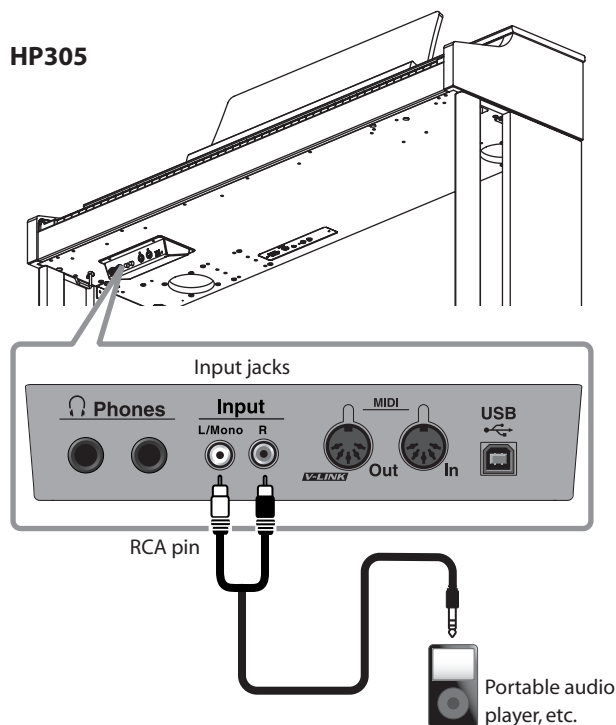

1. Turn the volume all the way down on the HP305/HP302 and on the audio device you're about to connect.
2. Turn off the power to the HP305/HP302 and audio device.
3. Use audio cables (sold separately) to make the connection.
4. Switch on the connected audio device.
5. Switch on the HP305/HP302.
6. Adjust the volume level on the HP305/HP302 and the connected audio device.

The sounds from the connected audio device are played by the HP305/HP302.

### MEMO

Adjust the volume by using the controls of your audio device.

### Turning Off the Power

1. Turn the volume all the way down on the HP305/HP302 and on the audio device you're about to connect.
2. Turn off the HP305/HP302.
3. Turn off the connected audio device.

## Connecting Speakers to the HP305/HP302 and Outputting Sounds

### HP305

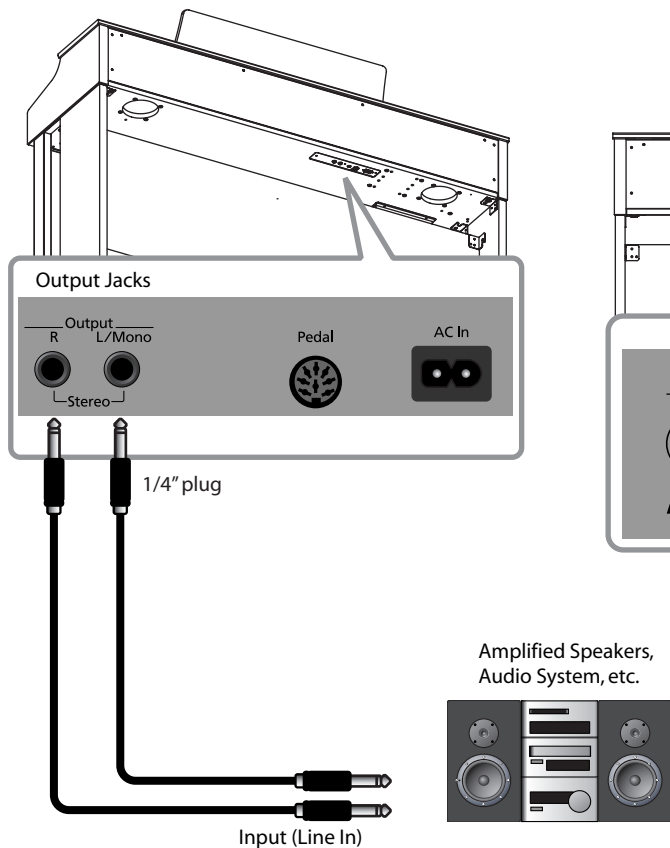

### HP302

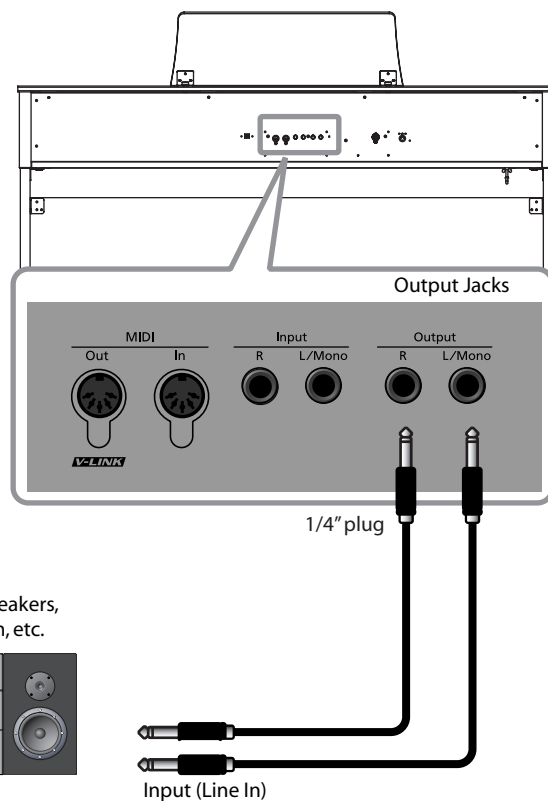

1. Turn the volume all the way down on the HP305/HP302 and on the device you're about to connect.
2. Turn off the power to the HP305/HP302 and speakers.
3. Use audio cables (sold separately) to make the connection.
4. Switch on the HP305/HP302.
5. Switch on the connected speakers.
6. Adjust the volume level on the HP305/HP302 and the connected speakers.

When you play the HP305/HP302's keyboard, the sound is played from the connected speakers.

### Turning Off the Power

1. Turn the volume all the way down on the HP305/HP302 and on the speakers you're about to connect.
2. Turn off the connected speakers.
3. Turn off the HP305/HP302.

## Connecting to MIDI Devices

By connecting an external MIDI device and exchanging performance data, you can control one device from the other. For instance, you can output sound from the other instrument or switch Tones on the other instrument.

### What's MIDI?

MIDI, short for "Musical Instrument Digital Interface," was developed as a universal standard for the exchange of performance data between electronic instruments and computers.

The HP305/HP302 is equipped with MIDI connectors to let it exchange performance data with external devices. These connectors can be used to connect the HP305/HP302 to an external device for even greater versatility.

## Connecting a MIDI Sequencer to the HP305/HP302

HP305

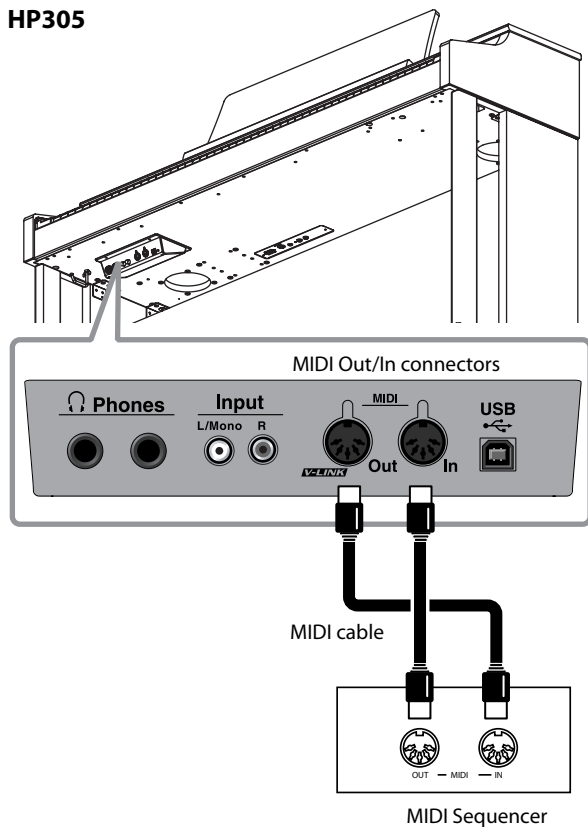

HP302

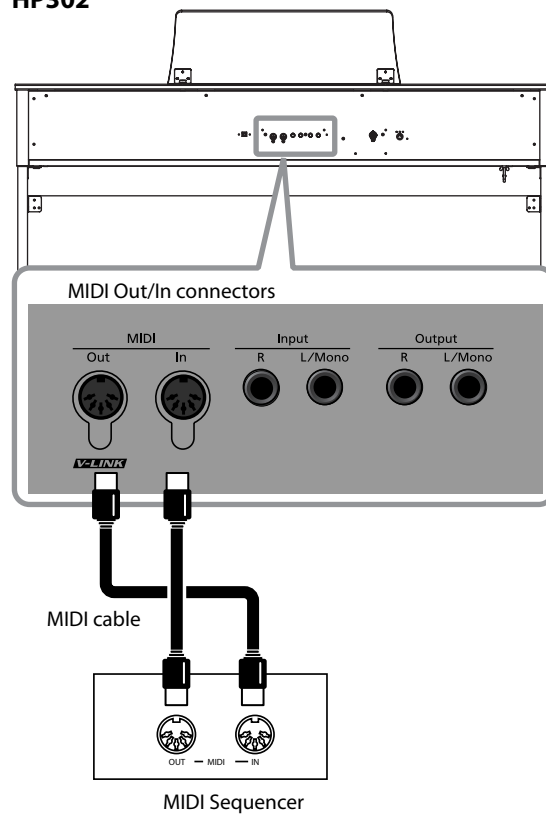

\* When the HP305/HP302 is connected to a MIDI sequencer, set it to "Local Off." Refer to "Preventing Doubled Notes When Connected to a Sequencer (Local Control)" (p. 71).

## Producing Sounds from a MIDI Sound Module by Playing the HP305/HP302

HP305

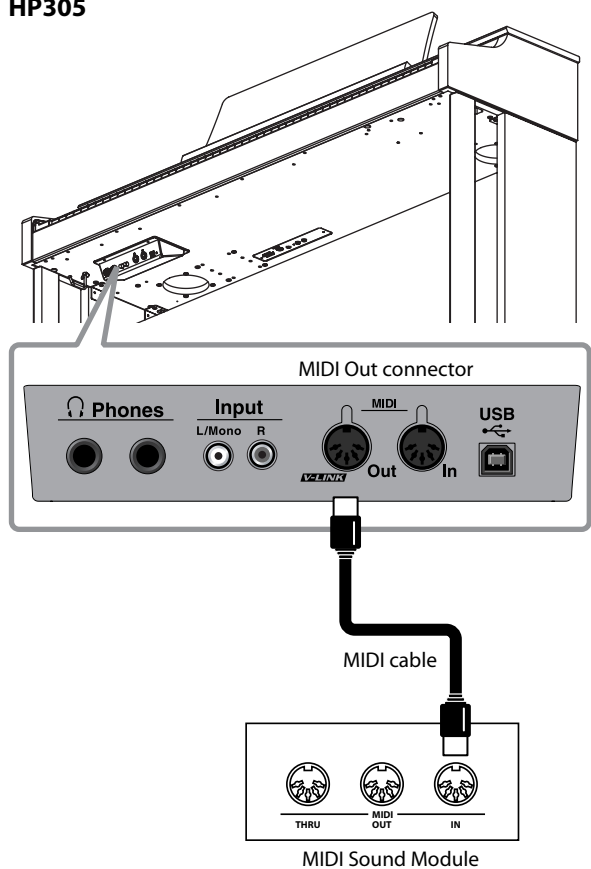

HP302

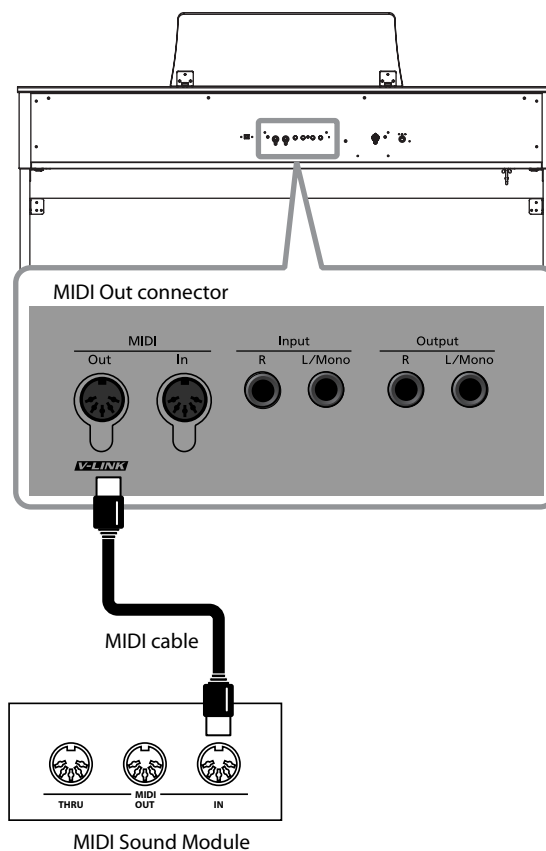

### Making the Connection

1. Turn the volume all the way down on the HP305/HP302 and on the MIDI device.
2. Switch off the power to the HP305/HP302 and the MIDI device.
3. Use a MIDI cables (sold separately) to connect the MIDI connectors to each other.
4. Switch on the power to the HP305/HP302 and the connected MIDI device.
5. Adjust the volume level on the HP305/HP302 and the connected MIDI device.
6. You should also set the MIDI transmit channel as needed.

**MEMO**

For details on the MIDI transmit channel, refer to "MIDI Transmit Channel Settings (MIDI Transmit Channel)" (p. 71).

## Preventing Doubled Notes When Connected to a Sequencer (Local Control)

When you have a MIDI sequencer connected, set this parameter to Local Off.

Since the Thru function of your sequencer will normally be turned on, notes played on the keyboard or played back by the recorder will be transmitted to the sound generator by the two routes (1) and (2) shown in the illustration, causing notes to be sounded in duplicate or to be cut off unnaturally. To prevent this, the setting called "Local Off" is used to disconnect the route in (1).

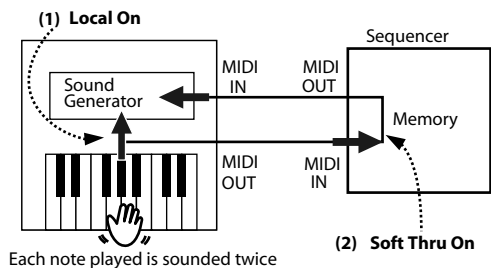

### Local On:

The keyboard and recorder are connected to the internal sound generator.

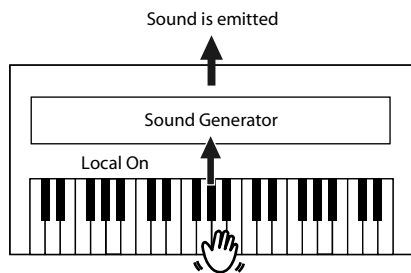

### Local Off:

The keyboard and recorder are not connected to the internal sound generator. No sound will be produced by the keyboard when it is played.

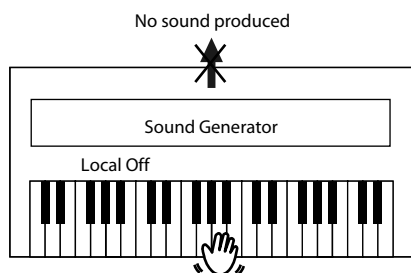

1. Enter Function mode, choose "L. Ct"(p. 55).



2. Press the [-] or [+] button to switch "On" or "OFF."

Setting	Description
On	The Local Control is set to On. The keyboard and recorder are connected to the internal sound generator.
OFF	The Local Control is set to Off. The keyboard and recorder are not connected to the internal sound generator. Playing the keyboard or playing back a song will not produce sound.

## MIDI Transmit Channel Settings (MIDI Transmit Channel)

This setting specifies the MIDI channel on which the HP305/HP302 will transmit. MIDI uses sixteen "MIDI channels," which are numbered 1 through 16. By connecting MIDI devices and specifying the appropriate MIDI channel for each device, you can play or select sounds on those devices.

The HP305/HP302 will receive all sixteen channels (1-16).

1. Enter Function mode, choose "Ch" (p. 55).



2. Press the [-] or [+] button to edit the setting.

Setting (Channel)
OFF, 1-16

### MEMO

When set to "OFF," none of the data describing what you play on the keyboard will be transmitted.

## Sending Recorded Performance Data to a MIDI Device (Composer MIDI Out)

When Composer MIDI Out is "On," you can send performance data recorded with the HP305/HP302 to a connected MIDI device or computer.

1. Enter Function mode, choose "Out"(p. 55).



2. Press the [-] or [+] button to switch "On" or "OFF."

Setting	Description
On	Performance data is transmitted.
OFF	Performance data is not transmitted.

## Connecting a Computer

The following become possible once you connect a USB cable (available separately) between the USB connector on the HP305's left end of the bottom panel or HP302's rear panel and the USB connector of your computer.

- You can use the HP305/HP302 to play sounds from SMF music files played back with MIDI software.
- By exchanging MIDI data with sequencer software, you can save songs recorded with the HP305/HP302 to your computer, and enjoy a variety of musical control and editing features.

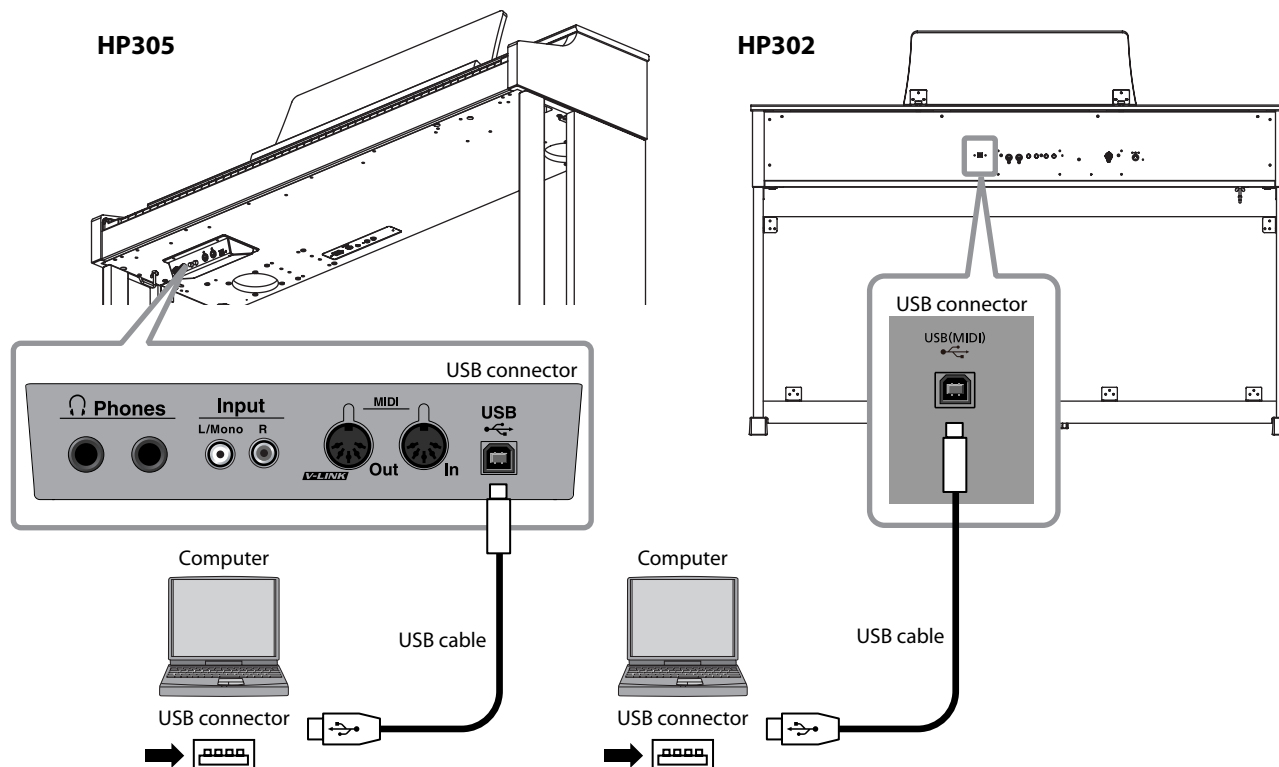

\* Connect the HP305/HP302 to your computer as shown below.

## Changing the USB Driver Settings (USB Driver)

Normally, you don't need to install a driver in order to connect the HP305/HP302 to your computer. However, if some problem occurs, or if the performance is poor, using the Roland original driver may solve the problem.

Specify the USB driver you want to use, and then install the driver.

### 1. Enter Function mode, choose "USB" (p. 55).



### 2. Press the [-] or [+] button to switch "GEn" or "OrG."

Setting	Description
Generic 	Choose this if you want to use the standard USB driver that was included with your computer. Normally, you should use this mode.
Original 	Choose this if you want to use a USB driver downloaded from the Roland website.

If you change this setting, turn on the power once again.

#### MEMO

This setting is remembered even when the power is turned off.

#### MEMO

For details on downloading and installing the Roland original driver, refer to the Roland website.

#### Roland website

Here you can download the original driver, and view the installation procedure and operating requirements.

Roland website: <http://www.roland.com/>

## Using the V-LINK Function

Connecting the HP305/HP302 to a V-LINK compatible image device allows you to control the images with the HP305/HP302.

- \* To prevent malfunction and/or damage to speakers or other devices, always turn down the volume, and turn off the power on all devices before making any connections.

### V-LINK

V-LINK (**V-LINK**) is a function that allows music and images to be performed together. By using MIDI to connect two or more V-LINK compatible devices, you can easily enjoy performing a wide range of visual effects that are linked to the expressive elements of a music performance.



1. Hold down the [Reverb] button and press the [Transpose] button.



When V-LINK is on, the bars at the bottom of the display will be lit.

You can control images using the twelve keys at the left end of the keyboard.

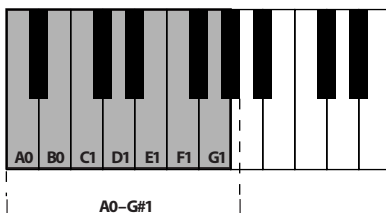

- \* While V-LINK is switched on, no sound is produced when you press any of the twelve keys at the left end of the keyboard.

#### MEMO

To cancel V-LINK, hold down the [Reverb] button and press the [Transpose] button.

### Specifying the V-LINK Transmit Channel

Here's how to specify the channel on which messages used to control video will be sent.

1. Enter Function mode, choose "vLn" (p. 55).



2. Use the [-] or [+] button to edit the setting.

#### Setting

1-16

# Troubleshooting

If you think there's a problem, read this first.

Symptom	Cause/Action	Page
Power does not turn on	Is the power cord connected correctly?	p. 18
Pedal does not work, or is "stuck"	Is the pedal connected correctly? Plug the cable firmly into the pedal connector.	p. 18
	If you disconnect the pedal cord from the HP305/HP302 while the power is on, the pedal effect may remain "stuck" in the On condition. You must power-off the HP305/HP302 before connecting or disconnecting the pedal cord.	—
	Could you have changed how the pedal effect is applied? If the right pedal part is set to Right, the pedal will apply only to the right tone; if it is set to Left, the pedal will apply only to the left tone.	p. 59
	Could Twin Piano be turned on? If Twin Piano is on, the right pedal will affect only the right-hand keyboard zone and the left pedal will affect only the left-hand keyboard zone.	p. 32
	Could you have changed the function of the pedal? If you've switched the function of the soft pedal or sostenuto pedal, these pedals will not operate as the soft pedal or sostenuto pedal.	p. 59
Unable to read from/write to USB memory	Are you using (optional) Roland USB memory? Reliable performance cannot be guaranteed if you use non-Roland USB memory products.	—
	If you are unable to read or write USB memory successfully, change the External Memory setting.	p. 63
"Buzz" is heard from external devices	Are the external devices connected to more than one AC power outlet? If you connect external devices, be sure to connect them to the same AC outlet.	—
Device connected to the Input jacks have insufficient volume	Could you be using a connection cable that contains a resistor? Use a connection cable that does not contain a resistor.	—

## No sound

No sound	Could the HP305/HP302's volume or the volume of the connected equipment be turned down?	p. 21
	Could headphones be connected? Could there be a plug inserted in a headphone jack? The speakers will not produce sound if headphones or plug are connected to the headphone jacks.	p. 23
	Has Local Control been set to "OFF"? When Local Control is set to Off, no sound is produced by playing the keyboard. Set Local Control to On.	p. 71
	Could Twin Piano mode be set to "2(Individual)"? If you connect headphones when Twin Piano is "on" and the mode setting is "2 (Individual)," you might not hear any sound, depending on how the headphones are connected.	p. 33
No sound when you play back a song	Has Local Control been set to "OFF"? When Local Control is set to Off, no sound is produced by playing the song. Set Local Control to On.	p. 71
	Could the song volume be set to "0"?	p. 41
No sound from the leftmost notes of the keyboard	Is V-LINK switched on? When V-LINK is on, the lowest twelve notes of the keyboard are used to control the image, and will not produce sound.	p. 73
No sound (when a MIDI device is connected)	Are all devices powered on?	—
	Are the MIDI cables connected correctly?	p. 69
	Do the MIDI channels of the HP305/HP302 and the connected device match?	p. 70



Symptom	Cause/Action	Page
<b>Notes don't sound right</b>		
Pitch of the keyboard or song is incorrect	Could you have made Transpose settings?	p. 37
	Is the Master Tune setting appropriate?	p. 58
	Is the setting for the Temperament correct?	p. 58
	Is the settings for the Stretch Tuning correct?	p. 58
Not all the notes you play are sounded	The maximum simultaneous polyphony is 128 voices. If you are playing along with a song and making heavy use of the damper pedal, the number of notes the HP305/HP302 is attempting to produce may exceed the maximum polyphony, meaning that some of the notes will drop out.	—
Sounds are heard twice (doubled) when the keyboard is played	Is the HP305/HP302 in Dual play?	p. 31
	When the HP305/HP302 is connected to an external sequencer, set the Local Control to off. Alternatively, the sequencer could be set so its Soft Thru feature is Off.	p. 71
The wrong instrument is selected when you press the [E. Piano], [Strings], or [Others] button	Tone buttons [E. Piano] [Strings] [Others] also operate as buttons that select "Recommended Tones." With the factory settings, connecting a commercially-available CD-ROM drive to the external memory connector and selecting a song from a CD-ROM produced for the VIMA (VIMA TUNES) will automatically cause sounds appropriate for that song to be assigned to the [E. Piano], [Strings], and [Others] Tone buttons, so that you can select "recommended" sounds by pressing one of these buttons. You can also make settings so that "recommended" sounds are not automatically assigned.	p. 73
Effect does not apply	When you are using Dual play or Split play, and different effects are specified for the two selected tones, the effect will not be applied to Tone 2 (when using Dual play) or the left-hand tone (when using Split play).	—
Reverberation remains even if You defeat the Reverb effect	The HP305/HP302's piano sound faithfully simulates the depth and resonance of an acoustic piano, and this may give the impression of reverberation even if you've defeated the Reverb effect.	—
The sound of the higher notes suddenly changes from a certain key	On an acoustic piano, the approximately one and a half octaves of notes at the top of the keyboard will continue sounding regardless of the damper pedal. These notes also have a somewhat different tonal character. HP305/HP302 faithfully simulate this characteristic of acoustic pianos. On the HP305/HP302, the range that is unaffected by the damper pedal will change according to the key transpose setting.	—
High-pitched ringing is heard	If you hear this in headphones: Piano sounds that have a brilliant and crisp character contain substantial high-frequency components that may sound as though a metallic ringing has been added. This is because the character of an actual piano is being faithfully reproduced, and is not a malfunction. This ringing is more obtrusive if the reverb effect is applied heavily, so you may be able to minimize it by decreasing the reverb.	—
	If you don't hear this in headphones: It is likely that there is some other reason (such as resonances within the unit). Please contact your dealer or a nearby Roland service center.	
Low notes sound wrong, or are buzzy	If you set the volume to the maximum setting, the sound may be distorted depending on how you perform. If this occurs, turn down the volume.	p. 21
	If you don't hear this in headphones: Performing at high volumes may cause the speakers or objects near the HP305/HP302 to resonate. Fluorescent lights or glass doors may also resonate sympathetically. In particular, this is more likely to occur for lower notes and higher volumes. You can take the following measures to minimize resonances. <ul style="list-style-type: none"> <li>• Locate the speakers 10–15 cm away from walls or other surfaces.</li> <li>• Keep the volume down.</li> <li>• Move away from the objects that are resonating.</li> </ul> If you hear this in headphones: It is likely that there is some other reason. Please contact your dealer or a nearby Roland service center.	—
<b>Song does not play correctly</b>		
Song won't play	Could the screen be indicating "dEL"? You can't play back an internal song if internal memory contains performance data you recorded. Erase the performance data you recorded before you play back the song.	p. 44
Only the sound of a particular instrument in a song does not play	Could a track be muted? If the button indicator is out, the music on that track is not heard. Press the track button so the indicator is illuminated.	p. 40
Sound is heard from a muted track	Could the mute volume be set to other than "0"? If you set this to "0," the sound of a muted track will be completely inaudible.	p. 60

## Troubleshooting

Symptom	Cause/Action	Page
Song volume is low	Could the song volume be lowered?	p. 41
Can't play back a song saved in USB memory	Could the Audio files of the format be played? Audio files of the following format can be played back. <ul style="list-style-type: none"> <li>• File extension ".WAV"</li> <li>• 16-bit linear</li> <li>• "44.1 kHz" sampling rate</li> </ul>	—
	Is the filename extension "MID"? Files with other filename extensions cannot be handled as song data.	—
Song tempo becomes unstable	When playing a song from USB memory, the tempo may become unstable if there is an excessive amount of performance data.	—
<b>Can't record / play back</b>		
Can't record	Has one of the track buttons for recording been selected?	p. 50 p. 53
	You cannot record audio files.	—
The recorded performance disappeared	Your recorded performance will disappear if you switch off the HP305/HP302's power or select a song. There is no way to recover the lost performance. Before you turn off the power, save your recorded performance in internal Memory.	p. 46
<b>Functions that cannot be used with audio file playback</b>		
<ul style="list-style-type: none"> <li>• Reverb (p. 29)</li> <li>• Saving to internal memory (p. 46)</li> <li>• Playback (muting) of individual parts (p. 40)</li> </ul>		

# Error Messages

Indication	Meaning
<b>E01</b>	You can only read the music file. It can not be saved.
<b>E02</b>	An error occurred during writing. The external media's protect tab may be in the "Protect" (writing prohibited) position, or the external media may not yet be initialized.
<b>E10</b>	No external media is inserted. Insert the external media and try again.
<b>E11</b>	There is not sufficient free memory in the save destination. Either insert other external media or delete unneeded files and try again.
<b>E14</b>	An error occurred during reading. The external media may be corrupted. Insert other external media and try again. Alternatively, you can initialize the external media.
<b>E15</b>	The file is unreadable. The data format is not compatible with the HP305/HP302.
<b>E16</b>	Data was not called up in time for playback of the song. After waiting several seconds, you may be able to play back the song by pressing the [ ▶/■ ] button again.
<b>E18</b>	This audio format is not supported. Please use 44.1 kHz 16-bit linear WAV format audio files.
<b>E30</b>	The internal memory capacity of the HP305/HP302 is full.
<b>E40</b>	The HP305/HP302 cannot deal with the excessive MIDI data sent from the external MIDI device. Reduce the amount of MIDI data sent to the HP305/HP302.
<b>E41</b>	A MIDI cable has been disconnected. Connect it properly and securely.
<b>E43</b>	A MIDI transmission error has occurred. Check the MIDI cable and connected MIDI device.
<b>E51</b>	There may be a problem with the system. Repeat the procedure from the beginning. If it is not solved after you have tried several times, contact the Roland service center.
<b>E65</b>	The External Memory connector was subjected to excessive current. Make sure that there is no problem with the external media, then turn the power off, then on again.
<b>---</b>	The Panel Lock function is on (p. 38).
<b>P-P</b>	The Twin Piano function is on (p. 32).
<b>dEL</b>	If you record a performance, then select a song before you've saved your recording, "dEL" will appear, flashing, in the display (p. 44).

\* External Media: USB memory, Floppy Disk, CD-ROM, etc.

# Tone List

## Piano

No.	Name
1	Grand Piano1
2	Piano + Str.
3	Harpsichord
4	Grand Piano2
5	Piano + Pad
6	Grand Piano3
7	MagicalPiano
8	Rock Piano
9	Piano+Choir
10	Honky-tonk
11	Coupled Hps.

## E. Piano

No.	Name
1	Pop E.Piano
2	Vintage EP
3	FM E.Piano
4	Vibraphone
5	EP Belle
6	Celesta
7	'60s E.Piano
8	Clav.
9	Mallet Isle
10	Morning Lite
11	Marimba
12	Stage Phaser
13	Ballad Bells
14	'70s E.Piano
15	E.Grand

## Strings

No.	Name
1	Rich Strings
2	OrchestraStr
3	Orchestra
4	ChamberWinds
5	Harp
6	Violin
7	Velo Strings
8	Flute
9	Cello
10	OrchestraBrs
11	PizzicatoStr
12	DecayStrings *

\* Tones indicated by "\*" are suitable for playing layered with a piano tone.

## Others

No.	Name
1	ChurchOrgan1
2	ChurchOrgan2
3	Combo Jz.Org
4	Ballad Organ
5	Accordion
6	Nason flt 8'
7	Gospel Spin
8	Full Stops
9	Mellow Bars
10	Light Organ
11	Lower Organ
12	'60s Organ
13	Aerial Choir
14	Jazz Scat
15	Harpvox
16	Glass Pad
17	Angels Choir
18	Beauty Vox
19	Soft Pad
20	Female Aahs
21	Male Aahs
22	Thum Voice
23	Lunar Strngs
24	Decay Choir *
25	Dcy ChoirPad *
26	Nylon-str.Gt
27	Steel-str.Gt
28	Jazz Guitar
29	AcousticBass
30	A.Bass+Cymb
31	FingeredBass
32	BrassSection
33	Alto Sax
34	Tenor Sax
<b>GM2</b>	
35	STANDARD Set
36	ROOM Set
37	POWER Set
38	ELEC.Set
39	ANALOG Set
40	JAZZ Set
41	BRUSH Set
42	ORCH.Set
43	SFX Set

\* 035-043 are drum sets.

No.	Name
44	Piano 1
45	Piano 1w
46	Piano 1d
47	Piano 2
48	Piano 2w
49	Piano 3
50	Piano 3w
51	Honky-tonk
52	Honky-tonk w
53	E.Piano 1
54	Detuned EP 1
55	Vintage EP
56	'60s E.Piano
57	E.Piano 2
58	Detuned EP 2
59	St.FM EP
60	EP Legend
61	EP Phase
62	Harpsichord
63	Coupled Hps.
64	Harpsi.w
65	Harpsi.o
66	Clav.
67	Pulse Clav.
68	Celesta
69	Glockenspiel
70	Music Box
71	Vibraphone
72	Vibraphone w
73	Marimba
74	Marimba w
75	Xylophone
76	TubularBells
77	Church Bell
78	Carillon
79	Santur
80	Organ 1
81	TremoloOrgan
82	'60s Organ
83	Organ 2
84	Perc.Organ 1
85	Chorus Organ
86	Perc.Organ 2
87	Rock Organ
88	Church Org.1
89	Church Org.2

No.	Name
90	Church Org.3
91	Reed Organ
92	Puff Organ
93	Accordion 1
94	Accordion 2
95	Harmonica
96	Bandoneon
97	Nylon-str.Gt
98	Ukulele
99	Nylon Gt o
100	Nylon Gt 2
101	Steel-str.Gt
102	12-str.Gt
103	Mandolin
104	Steel+Body
105	Jazz Guitar
106	Hawaiian Gt
107	Clean Guitar
108	Chorus Gt 1
109	Mid Tone Gt
110	Muted Guitar
111	Funk Guitar1
112	Funk Guitar2
113	Chorus Gt 2
114	Overdrive Gt
115	Guitar Pinch
116	DistortionGt
117	Gt Feedback1
118	Dist.Rtm Gt
119	Gt Harmonics
120	Gt Feedback2
121	AcousticBass
122	FingeredBass
123	Finger Slap
124	Picked Bass
125	FretlessBass
126	Slap Bass 1
127	Slap Bass 2
128	Synth Bass 1
129	WarmSyn.Bass
130	Synth Bass 3
131	Clav.Bass
132	Hammer
133	Synth Bass 2
134	Synth Bass 4
135	RubberSyn.Bs

No.	Name
136	Attack Pulse
137	Violin
138	Slow Violin
139	Viola
140	Cello
141	Contrabass
142	Tremolo Str.
143	PizzicatoStr
144	Harp
145	Yang Qin
146	Timpani
147	Strings
148	Orchestra
149	'60s Strings
150	Slow Strings
151	Syn.Strings1
152	Syn.Strings3
153	Syn.Strings2
154	Choir 1
155	Choir 2
156	Voice
157	Humming
158	Synth Voice
159	Analog Voice
160	OrchestraHit
161	Bass Hit
162	6th Hit
163	Euro Hit
164	Trumpet
165	Dark Trumpet
166	Trombone 1
167	Trombone 2
168	Bright Tb
169	Tuba
170	MuteTrumpet1
171	MuteTrumpet2
172	French Horn1
173	French Horn2
174	Brass 1
175	Brass 2
176	Synth Brass1
177	Synth Brass3
178	AnalogBrass1
179	Jump Brass
180	Synth Brass2
181	Synth Brass4

No.	Name
182	AnalogBrass2
183	Soprano Sax
184	Alto Sax
185	Tenor Sax
186	Baritone Sax
187	Oboe
188	English Horn
189	Bassoon
190	Clarinet
191	Piccolo
192	Flute
193	Recorder
194	Pan Flute
195	Bottle Blow
196	Shakuhachi
197	Whistle
198	Ocarina
199	Square Lead1
200	Square Lead2
201	Sine Lead
202	Saw Lead 1
203	Saw Lead 2
204	Doctor Solo
205	Natural Lead
206	SequencedSaw
207	Syn.Calliope
208	Chiffer Lead
209	Charang
210	Wire Lead
211	Solo Vox
212	5th Saw Lead
213	Bass+Lead
214	Delayed Lead
215	Fantasia
216	Warm Pad
217	Sine Pad
218	Polysynth
219	Space Voice
220	Itopia
221	Bowed Glass
222	Metallic Pad
223	Halo Pad
224	Sweep Pad
225	Ice Rain
226	Soundtrack
227	Crystal

## Tone List

No.	Name
228	Synth Mallet
229	Atmosphere
230	Brightness
231	Goblins
232	Echo Drops
233	Echo Bell
234	Echo Pan
235	Star Theme
236	Sitar 1
237	Sitar 2
238	Banjo
239	Shamisen
240	Koto
241	Taisho Koto
242	Kalimba
243	Bagpipe
244	Fiddle
245	Shanai
246	Tinkle Bell
247	Agogo
248	Steel Drums
249	Woodblock
250	Castanets
251	Taiko
252	Concert BD
253	Melodic Tom1
254	Melodic Tom2
255	Synth Drum
256	TR-808 Tom
257	Elec.Perc.
258	Reverse Cym.
259	Gt FretNoise
260	Gt Cut Noise
261	BsStringSlap
262	Breath Noise
263	Fl.Key Click
264	Seashore
265	Rain
266	Thunder
267	Wind
268	Stream
269	Bubble
270	Bird 1
271	Dog
272	Horse Gallop
273	Bird 2

No.	Name
274	Telephone 1
275	Telephone 2
276	DoorCreaking
277	Door
278	Scratch
279	Wind Chimes
280	Helicopter
281	Car Engine
282	Car Stop
283	Car Pass
284	Car Crash
285	Siren
286	Train
287	Jetplane
288	Starship
289	Burst Noise
290	Applause
291	Laughing
292	Screaming
293	Punch
294	Heart Beat
295	Footsteps
296	Gun Shot
297	Machine Gun
298	Laser Gun
299	Explosion

\* In the tone group "Others" when you hold down the [-] or [+] button to switch tone in succession, the tones will stop changing at number 35 and number 44.

To select the next sound, release the [-] or [+] button, then press it again.

# Internal Song List

No.	Song Name	Composer
1	Polonaise op.53	Fryderyk Franciszek Chopin
2	Valse, op.34-1	Fryderyk Franciszek Chopin
3	Nocturne No.20	Fryderyk Franciszek Chopin
4	My Pleasure (*)	Masashi Hirashita
5	La Fille aux Cheveux de Lin	Claude Achille Debussy
6	La Campanella	Franz Liszt
7	Trio Grande (*)	John Maul
8	Scherzo No.2	Fryderyk Franciszek Chopin
9	Étude, op.10-12	Fryderyk Franciszek Chopin
10	Sonate No.15	Wolfgang Amadeus Mozart
11	Liebesträume 3	Franz Liszt
12	Étude, op.10-3	Fryderyk Franciszek Chopin
13	Je te veux	Erik Satie
14	Valse, op.64-1	Fryderyk Franciszek Chopin
15	Golliwog's Cakewalk	Claude Achille Debussy
16	Fantaisie-Impromptu	Fryderyk Franciszek Chopin
17	Arabesque 1	Claude Achille Debussy
18	An der schönen, blauen Donau	Johann Strauss, Sohn
19	Auf Flügeln des Gesanges	Felix Mendelsshon
20	Mazurka No.5	Fryderyk Franciszek Chopin
21	Gymnopédie 1	Erik Satie
22	Étude, op.25-1	Fryderyk Franciszek Chopin
23	Clair de Lune	Claude Achille Debussy
24	Étude, op.10-5	Fryderyk Franciszek Chopin
25	Dr. Gradus ad Parnassum	Claude Achille Debussy
26	Grande Valse Brillante	Fryderyk Franciszek Chopin
27	La prière d'une Vierge	Tekla Badarzewska
28	Course en Troika	Peter Ilyich Tchaikovsky
29	To The Spring	Edvard Hagerup Grieg
30	Valse, op.64-2	Fryderyk Franciszek Chopin
31	Radetzky Marsch	Johann Baptist Strauss
32	Träumerei	Robert Alexander Schumann
33	Moments Musicaux 3	Franz Peter Schubert
34	Prélude, op.28-15	Fryderyk Franciszek Chopin
35	Harmonious Blacksmith	Georg Friedrich Händel
36	Ungarische Tänze 5	Johannes Brahms
37	Türkischer Marsch	Ludwig van Beethoven
38	Nocturne No.2	Fryderyk Franciszek Chopin
39	Frühlingslied	Felix Mendelsshon
40	Präludium	Johann Sebastian Bach
41	Jägerlied	Felix Mendelsshon
42	Menuet Antique	Maurice Ravel
43	Für Elise	Ludwig van Beethoven
44	Türkischer Marsch	Wolfgang Amadeus Mozart
45	Ständchen	Franz Peter Schubert

No.	Song Name	Composer
46	Humoreske	Antonín Dvořák
47	Blumenlied	Gustav Lange
48	Alpenglöckchen	Theodor Oesten
49	Menuett G dur	Ludwig van Beethoven
50	Venezianisches Gondellied	Felix Mendelsshon
51	Alpenabendröte	Theodor Oesten
52	Farewell to the Piano	Ludwig van Beethoven
53	Brautchor	Wilhelm Richard Wagner
54	Battle of Waterloo	Wilma Anderson-Gilman
55	Wiener Marsch	Carl Czerny
56	Le Coucou	Louis Claude Daquin
57	Menuett G dur	Johann Sebastian Bach
58	Spinnerlied	Albert Ellmenreich
59	Gavotte	François Joseph Gossec
60	Heidenröslein	Gustav Lange
61	Zigeuner Tanz	Heinrich Lichner
62	La Cinquantaine	Gabriel Marie
63	Csikos Post	Hermann Necke
64	Dolly's Dreaming Awakening	Theodor Oesten
65	La Violette	Louis Streabbog
66	Fröhlicher Landmann	Robert Alexander Schumann
67	Sonatine op.36-1	Muzio Clementi
68	Sonatine op.20-1	Friedrich Kuhlau
69	Sonatine No.5	Ludwig van Beethoven
70	Late Night Chopin (*)	John Maul
71	Fly Free (*)	John Maul
72	L'éveil de l'amour (*)	Masashi Hirashita

\* Songs marked by an asterisk (\*) are original songs composed for the Roland Corporation. The copyrights to these songs are owned by the Roland Corporation.

\* All rights reserved. Unauthorized use of this material for purposes other than private, personal enjoyment is a violation of applicable laws.

# Parameters Stored in Memory Backup

Items	Page
Brilliance	p. 57
Transpose Mode	p. 57
Dual Balance	p. 58
Master Tuning	p. 58
Stretch Tuning	p. 58
Temperament (Temperament, Temperament Key)	p. 58
Damper Resonance	p. 59
String Resonance	p. 59
Key Off Resonance	p. 59
Damper Pedal Part	p. 59
MIDI Transmit Channel	p. 71
V-LINK Transmit Channel	p. 73
Track Assign	p. 60
CD/Audio Type	p. 60
Reverb (On/Off, Depth)	p. 29
Split Point	p. 36
Twin Piano Mode	p. 33
Key Touch	p. 30
<b>Settings stored immediately, whenever a change is made (Memory Backup procedure not needed)</b>	
USB Driver Setting	p. 72
External Memory Mode	p. 63



# Music Files That the HP305/HP302 Can Use

## What Are Music Files?

Music files contain musical information such as how long the key for a corresponding pitch is played, the force applied to the key played, and other such information. When the performance data (music file) is sent by the USB memory or CD-ROM, the song will be played exactly as specified by the data. This is different than an audio CD, since the music file does not contain a recording of the sound itself. This makes it possible to change tempos and keys freely, allowing you to use it in many different ways.

## Regarding Copyright

Use of the song data supplied with the CD-ROM for any purpose other than private, personal enjoyment without the permission of the copyright holder is prohibited by law. Additionally, this data must not be copied, nor used in a secondary copyrighted work without the permission of the copyright holder.

Please be aware that if you create derivative works that are based on existing copyrighted material, such as commercially available SMF music files, such works may violate copyright law if used for any purpose other than personal enjoyment. Roland takes no responsibility for any copyright violation you may commit by creating such works.

## The HP305/HP302 Allows You To Use the Following Music Files

### VIMA TUNES

VIMA TUNES is a Roland specification for music files that contains image and lyric data, allowing you to enjoy songs with lyrics and images simultaneously. When data bearing the "VIMA TUNES" logo is played back on a device that bears the same logo, lyrics can be shown on the screen of a connected external display or television, letting you enjoy karaoke or watch a slide show.

- \* This instrument (HP305/HP302) is not able to play back VIMA TUNES images.
- \* You can specify whether the recommended tones will be assigned automatically (p. 65).

### SMF Music Files

SMFs (Standard MIDI Files) use a standard format for music file that was formulated so that files containing music file could be widely compatible, regardless of the manufacturer of the listening device. An enormous variety of music is available, whether it be for listening, for practicing musical instruments, for Karaoke, etc.

### General MIDI

The General MIDI is a set of recommendations which seeks to provide a way to go beyond the limitations of proprietary designs, and standardize the MIDI capabilities of sound generating devices. Sound generating devices and music files that meet the General MIDI standard bears the General MIDI logo. Music files bearing the General MIDI logo can be played back using any General MIDI sound generating unit to produce essentially the same musical performance.

### General MIDI 2

The upwardly compatible General MIDI 2 recommendations pick up where the original General MIDI left off, offering enhanced expressive capabilities, and even greater compatibility. Issues that were not covered by the original General MIDI recommendations, such as how sounds are to be edited, and how effects should be handled, have now been precisely defined. Moreover, the available sounds have been expanded. General MIDI 2 compliant sound generators are capable of reliably playing back music files that carry either the General MIDI or General MIDI 2 logo.

In some cases, the conventional form of General MIDI, which does not include the new enhancements, is referred to as "General MIDI 1" as a way of distinguishing it from General MIDI 2.

### GS Format

The GS Format is Roland's set of specifications for standardizing the performance of sound generating devices. In addition to including support for everything defined by the General MIDI, the highly compatible GS Format additionally offers an expanded number of sounds, provides for the editing of sounds, and spells out many details for a wide range of extra features, including effects such as reverb and chorus. Designed with the future in mind, the GS Format can readily include new sounds and support new hardware features when they arrive. Since it is upwardly compatible with the General MIDI, Roland's GS Format is capable of reliably playing back GM Scores equally as well as it performs GS music files (music files that have been created with the GS Format in mind).

### XGlite

XG is a tone generator format of YAMAHA Corporation, that defines the ways in which voices are expanded or edited and the structure and type of effects, in addition to the General MIDI 1 specification. XGlite is a simplified version of XG tone generation format. You can play back any XG music files using an XGlite tone generator. However, keep in mind that some music files may play back differently compared to the original files, due to the reduced set of control parameters and effects.

# MIDI Implementation Chart

DIGITAL PIANO  
Model HP305/302

Date : Sep. 1, 2009  
Version : 1.00

Function...		Transmitted	Recognized	Remarks
Basic Channel	Default Changed	1 1-16	1-16 1-16	
Mode	Default Messages Altered	Mode 3 x *****	Mode 3 Mode 3, 4 (M=1)	* 2
Note Number :	True Voice	15-113 *****	0-127 0-127	
Velocity	Note ON Note OFF	O O	O O	
After Touch	Key's Ch's	x x	O *1 O *1	
Pitch Bend		x	O	
Control Change		0, 32 O 1 x 5 x 6, 38 x 7 x 10 x 11 O 64 O 65 x 66 O 67 O 84 x 91 O 93 x 98, 99 x 100, 101 x	O *1 O *1 O *1 O *1 O *1 O *1 O *1 O *1 O *1 O *1 O *1 O *1 O *1 O *1 O (Reverb) O (Chorus) O *1 O *1	Bank select Modulation Portamento time Data entry Volume Panpot Expression Hold 1 Portamento Sostenuto Soft Portamento control Effect1 depth Effect3 depth NRPN LSB, MSB RPN LSB, MSB
Prog Change	: True #	0-127 *****	O 0-127	Program number 1-128
System Exclusive		O	O	
System Common	: Song Pos : Song Sel : Tune	x x x	x x x	
System Real Time	: Clock : Commands	O O	x x	
Aux Message	: All sound off : Reset all controllers : Local Control : All Notes OFF : Active Sense : Reset	x x x x O x	O (120, 126, 127) O O O (123-125) O x	
Notes		* 1 O x is selectable by Sys Ex. * 2 Recognized as M≠1 even if M=1.		

Mode 1 : OMNI ON, POLY  
Mode 3 : OMNI OFF, POLY

Mode 2 : OMNI ON, MONO  
Mode 4 : OMNI OFF, MONO

O : Yes  
X : No

# Main Specifications

## HP305/HP302: Digital Piano

### <Keyboard>

<b>Keyboard</b>	HP305: 88 keys (PHA II ivory feel Keyboard with Escapement)
	HP302: 88 keys (PHA II Keyboard with Escapement)
<b>Touch Sensitivity</b>	Touch: 5 levels / Fixed Touch
<b>Keyboard Mode</b>	Whole, Dual (volume balance adjustable), Split (split point adjustable), Twin piano

### <Sound Generator> Conforms to GM2/GS/XGlite

<b>Piano Sound</b>	SuperNATURAL Piano Sound
<b>Max. Polyphony</b>	128 voices
<b>Tones</b>	337 tones (including 8 drum sets, 1 SFX set)
<b>Temperament</b>	8 types, selectable temperament Key
<b>Stretched Tuning</b>	On, Off
<b>Master Tuning</b>	415.3–466.2 Hz (adjustable in increments of 0.1 Hz)
<b>Transpose</b>	Transpose: -6–+5 (in semitones) Playback Transpose (with Audio CD/Audio File): -6–+5 (in semitones)
<b>Effects</b>	Reverb (Off, 1–10), Rotary Speaker Effect (only for organ tones, Slow/Fast), Damper Resonance (Off, 1–10), String Resonance (Off, 1–10), Key Off Resonance (Off, 1–10)

### <Recorder>

<b>Tracks</b>	3 tracks
<b>Songs</b>	Recorder section: 1 song Internal Memory: Max. 99 songs
<b>Note Storage</b>	Approx. 30,000 notes
<b>Control</b>	Song Select, Play/Stop, Rec, Rewinding, Fast-forwarding, Track Mute, Mute Volume, Tempo, Tempo Mute, All Songs Play, Count-in, Song Volume
	Center Cancel (only for audio playback)
<b>Tempo</b>	Quarter note = 10 to 500, Audio Playback Speed: 75–125%
<b>Resolution</b>	120 ticks per quarter note
<b>Metronome</b>	Beat: 2/2, 0/4, 2/4, 3/4, 4/4, 5/4, 6/4, 7/4, 3/8, 6/8, 9/8, 12/8
	Volume: 0–10 levels

## Main Specifications

<b>&lt;Internal Memory&gt;</b>	
<b>Songs</b>	Max. 99 songs
<b>Save Song</b>	Standard MIDI Files (Format 0)
<b>&lt;External Memory&gt;</b>	
<b>External Storage</b>	USB Memory Floppy Disk (when using an optional floppy disk drive)
<b>Playable Software</b>	Standard MIDI Files (Format 0/1) Roland Original Format (i-Format) Audio File (WAV 44.1 kHz / 16-bit Linear Format) Audio CDs (CD-DA) (when using a CD drive)
<b>&lt;Others&gt;</b>	
<b>Internal Songs</b>	72 songs
<b>Rated Power Output</b>	HP305: 30 W x 2
	HP302: 12W x 2
<b>Speakers</b>	HP305: 12 cm x 2, 5 cm x 2
	HP302: 12 cm x 2
<b>Display</b>	7 segments, 3 characters, LED
<b>Control</b>	Volume
<b>Pedal</b>	Damper (capable of continuous detection), Soft (capable of continuous detection, function assignable), Sostenuto (function assignable)
<b>Other Function</b>	Panel Lock, Classic Position, V-LINK
<b>Connectors</b>	AC inlet, Input jacks (L/Mono, R), Output jacks (L/Mono, R), USB connector, MIDI connectors (In, Out), Phones jack (Stereo) x 2, External Memory connector
<b>Power Consumption</b>	HP305: 85 W
	HP302: 24 W
<b>Dimensions</b>	HP305 1387 (W) x 421 (D) x 1039 (H) mm (with Music Rest) 54-5/8 (W) x 16-5/8 (D) x 40-15/16 (H) inches
	1387 (W) x 448 (D) x 867 (H) mm (without Music Rest) 54-5/8 (W) x 17-11/16 (D) x 34-3/16 (H) inches
	HP302 1387 (W) x 424 (D) x 1036 (H) mm (with Music Rest) 54-5/8 (W) x 16-3/4 (D) x 40-13/16 (H) inches
	1387 (W) x 424 (D) x 860 (H) mm (without Music Rest) 54-5/8 (W) x 16-3/4 (D) x 33-7/8(H) inches
<b>Weight</b>	HP305: 57.5 kg / 126 lbs 13 oz 58.5 kg / 129 lbs (Polished-finish pianos)
	HP302: 53 kg / 116 lbs 14 oz
<b>Accessories</b>	Owner's Manual, Power Cord, AC adaptor (HP302), Music book, Headphones Hook, Music Rest(HP302), Music Rest attachment screws(HP302)

\* In the interest of product improvement, the specifications and/or appearance of this unit are subject to change without prior notice.

- A**
- AC Adaptor ..... 18
  - AC In (AC Inlet) ..... 15
  - Adjuster ..... 22
  - All Songs Play ..... 41
  - Audio Device ..... 67
  - Audio File ..... 65
- B**
- Brilliance ..... 56–57, 82
- C**
- CD Drive ..... 62
  - CD/Audio Type ..... 57, 60, 82
  - Center Cancel ..... 65
  - Center Pedal ..... 22
  - Center Pedal Function ..... 56
  - Center/Left Pedal Function ..... 59
  - Classic Position ..... 20
  - Composer MIDI Out ..... 57
  - Computer ..... 72
  - Count-in ..... 28
- D**
- Damper Pedal Part ..... 56, 59, 82
  - Damper Resonance ..... 56, 59, 82
  - DC In jack (DC Inlet) ..... 17
  - Deleting ..... 48, 66
  - Deleting a Song ..... 57
  - Display ..... 14, 16
  - [Display] button ..... 14, 16
  - Dual Balance ..... 56, 58, 82
  - Dual Play ..... 31
- E**
- Ext. Memory Mode ..... 63
  - External Memory connector ..... 15, 17
  - External Memory Mode ..... 57, 82
- F**
- Factory Reset ..... 57, 61
  - Floppy Disk Drive ..... 62
  - Forward button ..... 14, 16
  - Function Mode ..... 55
- G**
- General MIDI ..... 83
  - General MIDI 2 ..... 83
  - Ground terminal ..... 17
  - GS Format ..... 83
- H**
- Headphone ..... 23
  - Headphone Hook ..... 24
- I**
- Indicator ..... 14, 16
  - Individual ..... 33
  - Initializing ..... 63
  - Initializing the Memory ..... 57
  - Input jack ..... 15, 17
- K**
- Key ..... 56
  - Key Off Resonance ..... 56, 59, 82
  - Key Touch ..... 30, 82
  - [Key Touch] button ..... 14, 16
- L**
- Left pedal ..... 22
  - Left Pedal Function ..... 56
  - Local Control ..... 57, 71
- M**
- Master Tuning ..... 56, 58, 82
  - Memory Backup ..... 57, 61
  - Metronome ..... 26
  - [Metronome] button ..... 15, 17
  - MIDI ..... 69
  - MIDI Out/In connector ..... 15, 17
  - MIDI Sequencer ..... 69
  - MIDI Sound Module ..... 70
  - MIDI Transmit Channel ..... 57, 71, 82
  - Music CD ..... 65
  - Music Files ..... 83
  - Music Holder ..... 19–20
  - Music Rest ..... 19–20
  - Mute Volume ..... 57, 60
  - Muting ..... 40
- O**
- Octave Shift ..... 56–57
  - Output jack ..... 15, 17
- P**
- Pair ..... 33
  - Panel Lock ..... 38
  - Parts ..... 40
  - Pedal ..... 15, 17
  - Pedal connector ..... 15, 17
  - Pedal Cord ..... 18
  - Phones jack ..... 15, 17
  - Play/Stop button ..... 15, 17
  - Playback Transpose ..... 42, 65
  - Playing Back ..... 39, 64
  - Power Cord ..... 18
  - [Power] switch ..... 15, 17

**R**

[Rec] button .....	15, 17
Recommended Tone .....	57, 65
Recording .....	43
Reverb .....	29
Reverb (On/Off, Depth) .....	82
[Reverb] button .....	14, 16
Rewind button .....	14, 16

**S**

Save a Song .....	57
Saving .....	46, 66
Selecting a Song .....	64
SMF Music Files .....	83
SMF with Lyrics .....	83
Soft Pedal .....	22
Sostenuto Pedal .....	22
Speakers .....	68
Split Play .....	34
Split Point .....	36, 82
Stretch Tuning .....	56, 58, 82
String Resonance .....	56, 59, 82

**T**

Temperament .....	56, 58, 82
Temperament Key .....	56, 58, 82
Tempo Mute .....	57, 60
Tone button .....	14, 16
Track Assign .....	57, 60, 82
Track button .....	15, 17
Tracks .....	40
Transpose .....	37
[Transpose] button .....	14, 16
Transpose Mode .....	56–57, 82
Twin Piano .....	32
[Twin Piano] button .....	14, 16
Twin Piano Mode .....	33, 82

**U**

USB connector .....	15, 17
USB Driver .....	57, 72
USB Driver Setting .....	82
USB Memory .....	62

**V**

VIMA TUNES .....	83
V-LINK .....	73
V-LINK Transmit Channel .....	57, 73, 82
[Volume] slider .....	14, 16

**X**

XG lite .....	83
---------------	----

# MEMO

# MEMO



# MEMO



For EU Countries

This product complies with the requirements of EMCD 2004/108/EC and LVD 2006/95/EC. (HP305)  
This product complies with the requirements of EMC Directive 2004/108/EC. (HP302)

For the USA

## FEDERAL COMMUNICATIONS COMMISSION RADIO FREQUENCY INTERFERENCE STATEMENT

This equipment has been tested and found to comply with the limits for a Class B digital device, pursuant to Part 15 of the FCC Rules. These limits are designed to provide reasonable protection against harmful interference in a residential installation. This equipment generates, uses, and can radiate radio frequency energy and, if not installed and used in accordance with the instructions, may cause harmful interference to radio communications. However, there is no guarantee that interference will not occur in a particular installation. If this equipment does cause harmful interference to radio or television reception, which can be determined by turning the equipment off and on, the user is encouraged to try to correct the interference by one or more of the following measures:

- Reorient or relocate the receiving antenna.
- Increase the separation between the equipment and receiver.
- Connect the equipment into an outlet on a circuit different from that to which the receiver is connected.
- Consult the dealer or an experienced radio/TV technician for help.

This device complies with Part 15 of the FCC Rules. Operation is subject to the following two conditions:

- (1) this device may not cause harmful interference, and
- (2) this device must accept any interference received, including interference that may cause undesired operation.

Unauthorized changes or modification to this system can void the users authority to operate this equipment.  
This equipment requires shielded interface cables in order to meet FCC class B Limit.

For Canada

### NOTICE

This Class B digital apparatus meets all requirements of the Canadian Interference-Causing Equipment Regulations.

### AVIS

Cet appareil numérique de la classe B respecte toutes les exigences du Règlement sur le matériel brouilleur du Canada.

For C.A. US (Proposition 65)

### WARNING

This product contains chemicals known to cause cancer, birth defects and other reproductive harm, including lead.

For the USA

## DECLARATION OF CONFORMITY Compliance Information Statement

Model Name : HP305, HP302  
Type of Equipment : Digital Piano  
Responsible Party : Roland Corporation U.S.  
Address : 5100 S.Eastern Avenue, Los Angeles, CA 90040-2938  
Telephone : (323) 890-3700

**For EU Countries**



- UK** This symbol indicates that in EU countries, this product must be collected separately from household waste, as defined in each region. Products bearing this symbol must not be discarded together with household waste.
- DE** Dieses Symbol bedeutet, dass dieses Produkt in EU-Ländern getrennt vom Hausmüll gesammelt werden muss gemäß den regionalen Bestimmungen. Mit diesem Symbol gekennzeichnete Produkte dürfen nicht zusammen mit dem Hausmüll entsorgt werden.
- FR** Ce symbole indique que dans les pays de l'Union européenne, ce produit doit être collecté séparément des ordures ménagères selon les directives en vigueur dans chacun de ces pays. Les produits portant ce symbole ne doivent pas être mis au rebut avec les ordures ménagères.
- IT** Questo simbolo indica che nei paesi della Comunità europea questo prodotto deve essere smaltito separatamente dai normali rifiuti domestici, secondo la legislazione in vigore in ciascun paese. I prodotti che riportano questo simbolo non devono essere smaltiti insieme ai rifiuti domestici. Ai sensi dell'art. 13 del D.Lgs. 25 luglio 2005 n. 151.
- ES** Este símbolo indica que en los países de la Unión Europea este producto debe recogerse aparte de los residuos domésticos, tal como está regulado en cada zona. Los productos con este símbolo no se deben depositar con los residuos domésticos.
- PT** Este símbolo indica que nos países da UE, a recolha deste produto deverá ser feita separadamente do lixo doméstico, de acordo com os regulamentos de cada região. Os produtos que apresentem este símbolo não deverão ser eliminados juntamente com o lixo doméstico.
- NL** Dit symbool geeft aan dat in landen van de EU dit product gescheiden van huishoudelijk afval moet worden aangeboden, zoals bepaald per gemeente of regio. Producten die van dit symbool zijn voorzien, mogen niet samen met huishoudelijk afval worden verwijderd.
- DK** Dette symbol angiver, at i EU-lande skal dette produkt opsamlles adskilt fra husholdningsaffald, som defineret i hver enkelt region. Produkter med dette symbol må ikke smides ud sammen med husholdningsaffald.
- NO** Dette symbolet indikerer at produktet må behandles som spesialavfall i EU-land, iht. til retningslinjer for den enkelte regionen, og ikke kastes sammen med vanlig husholdningsavfall. Produkter som er merket med dette symbolet, må ikke kastes sammen med vanlig husholdningsavfall.

- SE** Symbolen anger att i EU-länder måste den här produkten kasseras separat från hushållsavfall, i enlighet med varje regions bestämmelser. Produkter med den här symbolen får inte kasseras tillsammans med hushållsavfall.
- FI** Tämä merkintä ilmaisee, että tuote on EU-maissa kerättävä erillään kotitalousjätteistä kunkin alueen voimassa olevien määräysten mukaisesti. Tällä merkinnällä varustettuja tuotteita ei saa hävittää kotitalousjätteiden mukana.
- HU** Ez a szimbólum azt jelenti, hogy az Európai Unióban ezt a terméket a háztartási hulladéktól elkülönítve, az adott régióban érvényes szabályozás szerint kell gyűjteni. Az ezzel a szimbóllal ellátott termékeket nem szabad a háztartási hulladék közé dobni.
- PL** Symbol oznacza, że zgodnie z regulacjami w odpowiednim regionie, w krajach UE produktu nie należy wyrzucać z odpadami domowymi. Produktów opatrzonych tym symbolem nie można utylizować razem z odpadami domowymi.
- CZ** Tento symbol udává, že v zemích EU musí být tento výrobek sbírán odděleně od domácího odpadu, jak je určeno pro každý region. Výrobky nesoucí tento symbol se nesmí vyhadzovat spolu s domácím odpadem.
- SK** Tento symbol vyjadruje, že v krajinách EÚ sa musí zber tohto produktu vykonávať oddelene od domového odpadu, podľa nariadení platných v konkrétnej krajine. Produkty s týmto symbolom sa nesmú vyhadzovať spolu s domovým odpadom.
- EE** See sümbol näitab, et EL-i maades tuleb see toode olemprügist eraldi koguda, nii nagu on igas piirkonnas määratletud. Selle sümboliga märgitud tooteid ei tohi ära visata koos olmeprügiga.
- LT** Šis simbolis rodo, kad ES šalyse šis produktas turi būti surenkamas atskirai nuo buitinių atliekų, kaip nustatyta kiekviename regione. Šiuo simboliu paženklinėti produktai neturi būti išmetami kartu su buitiniams atliekomis.
- LV** Šis simbols norāda, ka ES valstīs šo produktu jāievāc atsevišķi no mājsaimniecības atkritumiem, kā noteikts katrā reģionā. Produkts ar šo simbolu nedrīkst izmest kopā ar mājsaimniecības atkritumiem.
- SI** Ta simbol označuje, da je treba proizvod v državah EU zbirati ločeno od gospodinjjskih odpadkov, tako kot je določeno v vsaki regiji. Proizvoda s tem znakom ni dovoljeno odlagati skupaj z gospodinjjskimi odpadki.
- GR** Το σύμβολο αυτό υποδηλώνει ότι στις χώρες της Ε.Ε. το συγκεκριμένο προϊόν πρέπει να συλλέγεται χωριστά από τα υπόλοιπα οικιακά απορρίμματα, σύμφωνα με όσα προβλέπονται σε κάθε περιοχή. Τα προϊόντα που φέρουν το συγκεκριμένο σύμβολο δεν πρέπει να απορρίπτονται μαζί με τα οικιακά απορρίμματα.

**For China**

## 有关产品中所含有害物质的说明

本资料就本公司产品中所含的特定有害物质及其安全性予以说明。  
本资料适用于 2007 年 3 月 1 日以后本公司所制造的产品。

### 环保使用期限



此标志适用于在中国国内销售的电子信息产品，表示环保使用期限的年数。所谓环保使用期限是指在自制造日起的规定的期限内，产品中所含的有害物质不致引起环境污染，不会对人身、财产造成严重的不良影响。  
环保使用期限仅在遵照产品使用说明书，正确使用产品的条件下才有效。  
不当的使用，将会导致有害物质泄漏的危险。

### 产品中有毒有害物质或元素的名称及含量

部件名称	有毒有害物质或元素					
	铅(Pb)	汞(Hg)	镉(Cd)	六价铬(Cr(VI))	多溴联苯(PBB)	多溴二苯醚(PBDE)
外壳(壳体)	×	○	○	○	○	○
电子部件(印刷电路板等)	×	○	×	○	○	○
附件(电源线、交流适配器等)	×	○	○	○	○	○

○：表示该有毒有害物质在该部件所有均质材料中的含量均在 SJ/T11363-2006 标准规定的限量要求以下。  
×：表示该有毒有害物质至少在该部件的某一均质材料中的含量超出 SJ/T11363-2006 标准规定的限量要求。  
因根据现有的技术水平，还没有什么物质能够代替它。

## Information

When you need repair service, call your nearest Roland Service Center or authorized Roland distributor in your country as shown below.

### AFRICA

#### EGYPT

**Al Fanny Trading Office**  
9, EBN Hagar Al Askalany Street,  
ARD E1 Golf, Heliopolis,  
Cairo 11341, EGYPT  
TEL: (022)-417-1828

#### REUNION

**MARCEL FO-YAM Sarl**  
25 Rue Jules Hermann,  
Chaudron - BP79 97 491  
Ste Clotilde Cedex,  
REUNION ISLAND  
TEL: (0262) 218-429

#### SOUTH AFRICA

**T.O.M.S. Sound & Music (Pty)Ltd.**  
2 ASTRON ROAD DENVER  
JOHANNESBURG ZA 2195,  
SOUTH AFRICA  
TEL: (011)417 3400

#### Paul Bothner(PTY)Ltd.

Royal Cape Park, Unit 24  
Londonderry Road, Ottery 7800  
Cape Town, SOUTH AFRICA  
TEL: (021) 799 4900

### ASIA

#### CHINA

**Roland Shanghai Electronics Co.,Ltd.**  
5F, No.1500 Pingliang Road  
Shanghai 200090, CHINA  
TEL: (021) 5580-0800

#### Roland Shanghai Electronics Co.,Ltd.

(BEIJING OFFICE)  
10F, No.18 3 Section Anhuaxili  
Chaoyang District Beijing 100011  
CHINA  
TEL: (010) 6426-5050

#### HONG KONG

**Tom Lee Music**  
11/F Silvercord Tower 1  
30 Canton Rd  
Tsimshatsui, Kowloon  
Hong Kong  
TEL: 825-2737-7688

#### Parsons Music Ltd.

8th Floor, Railway Plaza, 39  
Chatham Road South, T.S.T,  
Kowloon, HONG KONG  
TEL: 2333 1863

#### INDIA

**Rivera Digitec (India) Pvt. Ltd.**  
411, Niman Kendra Mahalaxmi  
Flats Compound Off. Dr. Edwin  
Moses Road, Mumbai-400011,  
INDIA  
TEL: (022) 2493 9051

#### INDONESIA

**PT Citra Intirama**  
Jl. Cideng Timur No. 15J-150  
Jakarta Pusat  
INDONESIA  
TEL: (021) 6324170

#### KOREA

**Cosmos Corporation**  
1461-9, Seocho-Dong,  
Seocho Ku, Seoul, KOREA  
TEL: (02) 3486-8855

#### MALAYSIA

**Roland Asia Pacific Sdn. Bhd.**  
45-1, Block C2, Jalan PJU 1/39,  
Dataran Prima, 47301 Petaling  
Jaya, Selangor, MALAYSIA  
TEL: (03) 7805-3263

#### VIET NAM

**VIET THUONG CORPORATION**  
386 CACH MANG THANG TAM ST.  
DIST.3,  
HO CHI MINH CITY  
VIET NAM  
TEL: (08) 9316540

#### PHILIPPINES

**G.A. Yupangco & Co. Inc.**  
339 Gil J. Puyat Avenue  
Makati, Metro Manila 1200,  
PHILIPPINES  
TEL: (02) 899 9801

#### SINGAPORE

**SWEE LEE MUSIC COMPANY PTE. LTD.**  
150 Sims Drive,  
SINGAPORE 387381  
TEL: 6846-3676

#### TAIWAN

**ROLAND TAIWAN ENTERPRISE CO., LTD.**  
9F-5, No. 112 Chung Shan  
North Road Sec. 2 Taipei 104  
TAIWAN R.O.C.  
TEL: (02) 2561 3339

#### THAILAND

**Theera Music Co., Ltd.**  
100-108 Soi Verng Nakornkasem,  
New Road,Sumpantawong,  
Bangkok 10100 THAILAND  
TEL: (02) 224-8821

### OCEANIA

#### AUSTRALIA/ NEW ZEALAND

**Roland Corporation  
Australia Pty.,Ltd.**  
38 Campbell Avenue  
Dee Why West. NSW 2099  
AUSTRALIA

For Australia  
Tel: (02) 9982 8266  
For New Zealand  
Tel: (09) 3098 715

### CENTRAL/LATIN AMERICA

#### ARGENTINA

**Instrumentos Musicales S.A.**  
Av.Santa Fe 2055  
(1123) Buenos Aires  
ARGENTINA  
TEL: (011) 4508-2700

#### BARBADOS

**A&B Music Supplies LTD**  
12 Webster Industrial Park  
Wildely, St.Michael, Barbados  
TEL: (246)430-1100

#### BRAZIL

**Roland Brasil Ltda.**  
Rua San Jose, 211  
Parque Industrial San Jose  
Cotia - Sao Paulo - SP, BRAZIL  
TEL: (011) 4615 5666

#### CHILE

**Comercial Fancy II S.A.**  
Rut: 96.919.420-1  
Nataaniel Cox #739, 4th Floor  
Santiago - Centro, CHILE  
TEL: (02) 688-9540

#### COLOMBIA

**Centro Musical Ltda.**  
Cra 43 B No 25 A 41 Bododega 9  
Medellin, Colombia  
TEL: (574)3812529

#### COSTA RICA

**JUAN Bansbach Instrumentos Musicales**  
Ave.1. Calle 11, Apartado 10237,  
San Jose, COSTA RICA  
TEL: 258-0211

#### CURACAO

**Zeelandia Music Center Inc.**  
Orionweg 30  
Curacao, Netherland Antilles  
TEL:(305)5926866

#### DOMINICAN REPUBLIC

**Instrumentos Fernando Giraldez**  
Calle Proyecto Central No.3  
Ens.La Esperilla  
Santo Domingo,  
Dominican Republic  
TEL:(809) 683 0305

#### ECUADOR

**Mas Musica**  
Rumichaca 822 y Zaruma  
Guayaquil - Ecuador  
TEL:(593-4)2302364

#### EL SALVADOR

**OMNI MUSIC**  
75 Avenida Norte y Final Alameda  
Juan Pablo II,  
Edificio No.4010 San Salvador,  
EL SALVADOR  
TEL: 262-0788

#### GUATEMALA

**Casa Instrumental**  
Calzada Roosevelt 34-01,zona 11  
Ciudad de Guatemala  
Guatemala  
TEL:(502) 599-2888

#### HONDURAS

**Almacen Pajaro Azul S.A. de C.V.**  
BO.Paz Barahona  
3 Ave.11 Calle S.O  
San Pedro Sula, Honduras  
TEL: (504) 553-2029

#### MARTINIQUE

**Musique & Son**  
Zi.Les Mangle  
97232 Le Lamantin  
Martinique F.W.I.  
TEL: 596 596 426860

#### Gigamusic SARKL

10 Rte De La Folie  
97200 Fort De France  
Martinique F.W.I.  
TEL: 596 596 715222

#### MEXICO

**Casa Veerkamp, s.a. de c.v.**  
Av. Toluca No. 323, Col. Olivar  
de los Padres 01780 Mexico D.F.  
MEXICO  
TEL: (55) 5668-6699

#### NICARAGUA

**Bansbach Instrumentos Musicales Nicaragua**  
Altamira D'Este Calle Principal  
de la Farmacia 5ta.Avenida  
1 Cuadra al Lago.#503  
Managua, Nicaragua  
TEL: (505)277-2557

#### PANAMA

**SUPRO MUNDIAL, S.A.**  
Boulevard Andrews, Albrook,  
Panama City, REP. DE PANAMA  
TEL: 315-0101

#### PARAGUAY

**Distribuidora De Instrumentos Musicales**  
J.E. Olear y ESQ. Manduvira  
Asuncion PARAGUAY  
TEL: (595) 21 492147

#### PERU

**Audionet**  
Distribuciones Musicales SAC  
Juan Fanning 530  
Miraflores  
Lima - Peru  
TEL: (511) 4461388

#### TRINIDAD

**AMR Ltd**  
Ground Floor  
Maritime Plaza  
Barataria Trinidad W.I.  
TEL: (868) 638 6385

#### URUGUAY

**Todo Musica S.A.**  
Francisco Acuna de Figueroa  
1771  
C.P.: 11.800  
Montevideo, URUGUAY  
TEL: (02) 924-2335

#### VENEZUELA

**Instrumentos Musicales**  
**Allegro, C.A.**  
Av.las industrias edf.Guitar import  
#7 zona Industrial de Turumo  
Caracas, Venezuela  
TEL: (212) 244-1122

### EUROPE

#### BELGIUM/FRANCE/ HOLLAND/ LUXEMBOURG

**Roland Central Europe N.V.**  
Houtstraat 3, B-2260, Oevel  
(Westerlo) BELGIUM  
TEL: (014) 575811

#### CROATIA

**ART-CENTAR**  
Degenova 3,  
HR - 10000 Zagreb  
TEL: (1) 466 8493

#### CZECH REP.

**CZECH REPUBLIC DISTRIBUTOR**  
s.r.o  
Vocáárova 247/16  
CZ - 180 00 PRAHA 8,  
CZECH REP.  
TEL: (2) 830 20270

#### DENMARK

**Roland Scandinavia A/S**  
SKAGERRAKVEJ 7 POSTBOX 880  
DK-2100 OPENHAGEN,  
DENMARK  
TEL: 3916 6200

#### FINLAND

**Roland Scandinavia As, Filial  
Finland**  
Vanha Nurmijarventie 62  
01670 Vantaa  
Finland  
TEL: (0)9 68 24 020

#### GERMANY/AUSTRIA

**Roland Elektronische  
Musikinstrumente HmbH.**  
Oststrasse 96, 22844 Norderstedt,  
GERMANY  
TEL: (040) 52 60090

#### GREECE/CYPRUS

**STOLLAS S.A.**  
**Music Sound Light**  
155, New National Road  
Patras 26442, GREECE  
TEL: 2610 435400

#### HUNGARY

**Roland East Europe Ltd.**  
2045 Torokbalint, FSD Park,  
building 3.  
TEL: (23) 51 1011

#### IRELAND

**Roland Ireland**  
G2 Calmont Park, Calmont  
Avenue, Dublin 12  
Republic of IRELAND  
TEL: (01) 4294444

#### ITALY

**Roland Italy S. p. A.**  
Viale delle Industrie 8,  
20020 Arese, Milano, ITALY  
TEL: (02) 937-78300

#### NORWAY

**Roland Scandinavia Avd.  
Kontor Norge**  
Lilleakerveien 2 Postboks 95  
Lilleaker N-0216 Oslo  
NORWAY  
TEL: 2273 0074

#### POLAND

**ROLAND POLSKA SP. Z O.O.**  
ul. Kty Grodziskie 16B  
03-289 Warszawa, POLAND  
TEL: (022) 678 9512

#### PORTUGAL

**Roland Iberia, S.L.  
Branch Office Porto**  
Edificio Tower Plaza  
Rotunda Eng. Edgar Cardoso  
23, 9ºG  
4400-676 VILA NOVA DE GAIA  
PORTUGAL  
TEL:(+351) 22 608 00 60

#### ROMANIA

**FBS LINES**  
Piata Libertatii 1,  
535500 Gheorgheni, ROMANIA  
TEL: (266) 364 609

#### RUSSIA

**Roland Music LLC**  
Dorozhnaya ul.3,korp.6  
117 545 Moscow, RUSSIA  
TEL: (095) 981-4967

#### SERBIA

**Music AP Ltd.**  
Sutjeska br. 5 XS - 24413 Palic,  
SERBIA  
TEL: (024) 539 395

#### SLOVAKIA

**DAN Acoustic s.r.o.**  
Povazská 18,  
SK - 940 01 Nové Zámky  
TEL: (035) 6424 330

#### SPAIN

**Roland Iberia, S.L.**  
Paseo Garcia Faria, 33-35  
08005 Barcelona SPAIN  
TEL: 93 493 91 00

#### SWEDEN

**Roland Scandinavia A/S  
SWEDISH SALES OFFICE**  
Mårbackagatan 31, 4 tr.  
SE-123 43 Farsta  
Sweden  
TEL: (0)8 683 04 30

#### SWITZERLAND

**Roland (Switzerland) AG**  
Landstrasse 5, Postfach,  
CH-4452 Itingen, SWITZERLAND  
TEL: (061)975-9987

#### UKRAINE

**EURHYTHMIC Ltd.**  
P.O.Box: 37-a  
Nedecy Str. 30  
UA - 89600 Mukachevo, UKRAINE  
TEL: (03131) 414-40

#### UNITED KINGDOM

**Roland (U.K.) Ltd.**  
Atlantic Close, Swansea  
Enterprise Park, SWANSEA  
SA7 9FJ,  
UNITED KINGDOM  
TEL: (01792) 702701

### MIDDLE EAST

#### BAHRAIN

**Moon Stores**  
No.1231&1249 Rumaytha  
Building Road 3931, Manama 339  
BAHRAIN  
TEL: 17 813 942

#### IRAN

**MOCO INC.**  
No.41 Nike St., Dr.Shariyati Ave.,  
Roberoye Cerahe Mirdamad  
Tehran, IRAN  
TEL: (021)-2285-4169

#### ISRAEL

**Halilit P. Greenspoon & Sons  
Ltd.**  
8 Retzif Ha'alila Hashnia St.  
Tel-Aviv-Yafo ISRAEL  
TEL: (03) 6823666

#### JORDAN

**MUSIC HOUSE CO. LTD.  
FREDDY FOR MUSIC**  
P. O. Box 922846  
Amman 11192 JORDAN  
TEL: (06) 5692696

#### KUWAIT

**EASA HUSAIN AL-YOUSIFI &  
SONS CO.**  
Al-Yousifi Service Center  
P.O.Box 126 (Safat) 13002  
KUWAIT  
TEL: 00 965 802929

#### LEBANON

**Chahine S.A.L.**  
George Zeidan St., Chahine Bldg.,  
Achrafieh, P.O.Box: 16-5857  
Beirut, LEBANON  
TEL: (01) 20-1441

#### OMAN

**TALENTZ CENTRE L.L.C.**  
Malatan House No.1  
Al Noor Street, Ruwi  
SULTANATE OF OMAN  
TEL: 2478 3443

#### QATAR

**AI Emadi Co. (Badie Studio  
& Stores)**  
P.O. Box 62, Doha, QATAR  
TEL: 4423-554

#### SAUDI ARABIA

#### ADawlah Universal Electronics

**APL**  
Behind Pizza Inn  
Prince Turkey Street  
aDawlah Building,  
PO BOX 2154,  
Alkhobar 31952  
SAUDI ARABIA  
TEL: (03) 8643601

#### SYRIA

**Technical Light & Sound Center**  
PO BOX 13520 BLDG No.17  
ABDUL WAHAB KANAWATI,ST  
RAWDA DAMASCUS, SYRIA  
TEL: (011) 223-5384

#### TURKEY

**ZUHAL DIS TICARET A.S.**  
Galip Dede Cad. No.37  
Beyoglu - Istanbul / TURKEY  
TEL: (0212) 249 85 10

#### U.A.E.

**Zak Electronics & Musical  
Instruments Co. L.L.C.**  
Zabeel Road, Al Sherooq Bldg.,  
No. 14, Ground Floor, Dubai,  
U.A.E.  
TEL: (04) 3360715

### NORTH AMERICA

#### CANADA

**Roland Canada Ltd.**  
(Head Office)  
5480 Parkwood Way Richmond B.  
C., V6V 2M4 CANADA  
TEL: (604) 270 6626

#### Roland Canada Ltd.

(Toronto Office)  
170 Admiral Boulevard  
Mississauga On L5T 2N6 CANADA  
TEL: (905) 362 9707

#### U. S. A.

**Roland Corporation U.S.**  
5100 S. Eastern Avenue  
Los Angeles, CA 90040-2938,  
U. S. A.  
TEL: (323) 890 3700

## Free Manuals Download Website

<http://myh66.com>

<http://usermanuals.us>

<http://www.somanuals.com>

<http://www.4manuals.cc>

<http://www.manual-lib.com>

<http://www.404manual.com>

<http://www.luxmanual.com>

<http://aubethermostatmanual.com>

Golf course search by state

<http://golfingnear.com>

Email search by domain

<http://emailbydomain.com>

Auto manuals search

<http://auto.somanuals.com>

TV manuals search

<http://tv.somanuals.com>