



DCB DIGITAL KEYBOARD RECORDER

JSQ-60



The JSQ-60 is a polyphonic sequencer featuring DCB standard, and can be used with the following keyboards.

Juno-60
Jupiter-8

(Contact your nearest Roland dealer, if your Jupiter-8 is prior to serial No. 282879.)

FEATURES

- The JSQ-60 features Step Load function, that is loading a note or chord step by step by setting a pitch or pitches one after another. By using the REST and TIE Buttons, fairly complicated music pieces can be loaded. Therefore, you can chose either Step Load or Real time load mode.
- It is possible to overdub on the existing data up to three times in Real time mode.
- The Patch Shift of the Juno-60 or Patch Preset of the JP-8 can be memorized.
- Tape Interface allows loading the data in the JSQ-60's memory onto an ordinary audio tape for storage and later retrieval.
- Two Sync Out Jacks (DIN) allowing synchronization with another sequencer or the rhythm machine featuring Sync In.
- Up to 2000 notes can be written into the JSQ-60, and the Memory Indicator tells you how much memory has been consumed so far.

CONTENTS

Features	P. 2
Important Notes	
Power Supply	P. 3
Location	P. 3
Cleaning	P. 3
Others	P. 3
Front Panel	P. 4
Panel Description	P. 5
Connection	P. 6
Load and Playback	P. 7
Real Time Load	P. 7
Play/Repeat	P. 8
Tempo/Metronome	P. 8
Step Load	P. 9
Edit	P. 11
Continue Load	P. 12
Overdub	P. 13
Tape Interface	P. 14
Save	P. 15
Verify	P. 15
Load	P. 16
Application	P. 16
Patch Shift	P. 17
Patch Preset	P. 17
Start/Stop	P. 18
SYNC	P. 18
MIDI	P. 18
Error	P. 19
Specifications	P. 20

IMPORTANT NOTES

POWER SUPPLY

- The JSQ-60 adapts AC powered system. Be sure to use the supplied AC Adaptor. Using any other adaptor will cause malfunction or even break down.
- Do not turn the JSQ-60 on, before connecting the AC Adaptor to it.
- This unit might not work properly if turned on immediately after turned off. If this happens, simply turn it off again and turn it on a few seconds later.
- Before setting up the JSQ-60 with an external synthesizer, be sure to turn both of them off.

LOCATION

- Using the JSQ-60 near a neon or fluorescent lamp may cause noise interference. If so, change the angle or position of the JSQ-60.
- Avoid using the JSQ-60 in extreme heat or humidity or where it may be affected by dust.

CLEANING

- Use a soft cloth and clean only with a mild detergent.
- Do not use solvents such as paint thinner.

OTHERS

- If the AC Adaptor is connected, turning the Power Switch off does not erase the data in memory, but in about a day after the AC Adaptor is disconnected, its data will be completely erased. So it may be a good idea to load all data onto a cassette tape for precaution.
- Do not pull the DCB cord hard.

FRONT PANEL

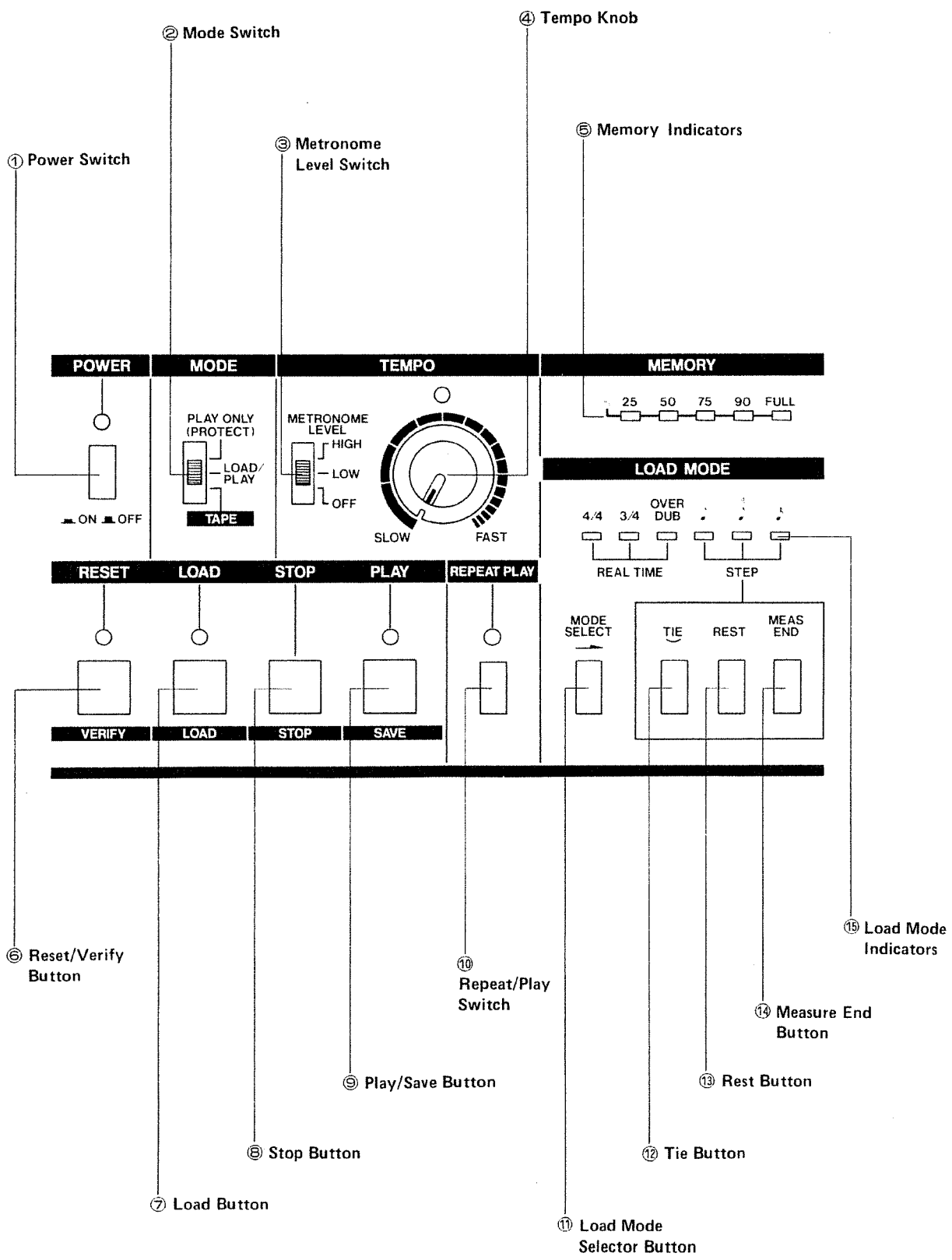

PANEL DESCRIPTION

① Power Switch

Pushing this switch on will light up the Indicator and turns the JSQ-60 on.

② Mode Switch

The JSQ-60 includes two modes for sequencer, and a mode for loading the sequencer data onto a tape as follows.

- Play Only (Protect) mode
This mode is to playback the data you have written into the sequencer, but writing is not possible in this mode.
To protect the data from accidental loss, always turn the JSQ-60 into this mode except when loading.
- Load/Play mode
This mode is for loading, playing back, editing and overdubbing.
- Tape mode
This mode is for saving sequencer data onto a tape, and later loading it back to the sequencer.

< NOTE >

Be sure that the JSQ-60 is not running while changing the modes. The data will be erased if you change the modes during loading operation.

③ Metronome Level Switch

This is to adjust the volume of the metronome sound.

④ Tempo knob

This sets the tempo in playing or real time loading.

⑤ Memory Indicator

This shows how much memory is consumed so far. Also, it flashes when there is any error made.

⑥ Reset/Verify Button

- Reset (in Play Only or Load/Play mode)
This is to reset the data for loading or playing back from the beginning.
- Verify (in Tape mode)
Here, the same button works as a verify button for the data saved on a tape.

⑦ Load Button

- Load (in Load/Play mode)
Press this button in loading the data into sequencer.
- Load (in Tape mode)
Here, this button is used to load the data saved on a tape back to the JSQ-60.

⑧ Stop Button

Press this when loading is completed, or to stop playing in the middle of the data.
In Tape mode, this button is used to stop save, load or verify.

⑨ Play/Save Button

- Play (in Play Only or Load/Play mode)
Press this button in playing back the loaded data.
- Save (in Tape mode)
Here, this button is used in saving the sequencer data onto a tape.

⑩ Repeat Play Switch

If this switch is pushed on and the Play Button pressed, the data will repeat playing until the Stop or Reset Button is pressed.

⑪ Load Mode Selector Button

This button is to select a mode for loading and it works only when the JSQ-60 is not running.

⑫ Tie Button

This is to load tie or slar.

⑬ Rest Button

This is to load rests.

⑭ Measure End Button

This is to load bar lines.

⑮ Load Mode Indicators

The one selected with the Load Mode Selector Button will light up. None of these lights in Play or Tape mode.

CONNECTION

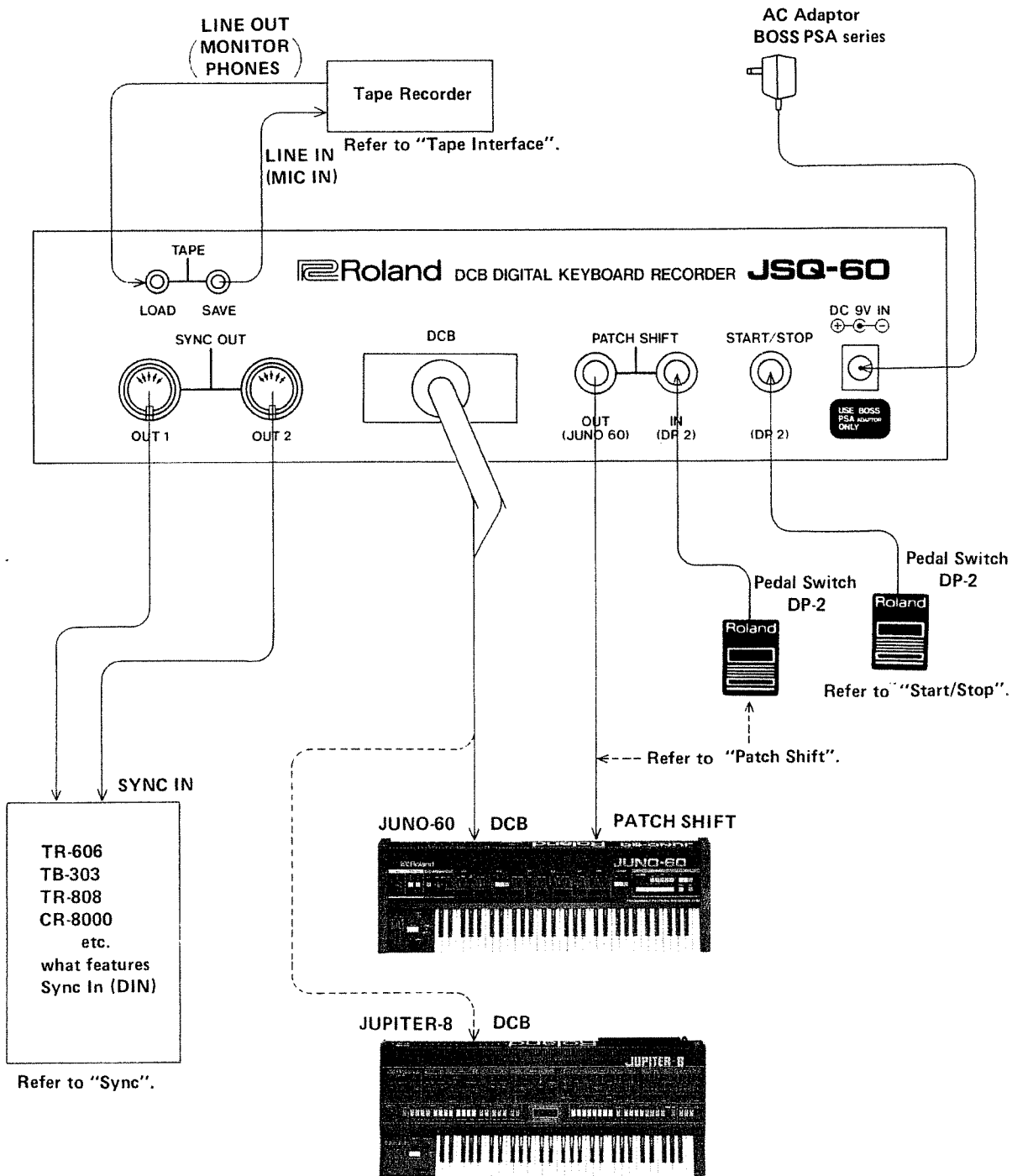

If your JP-8 does not feature DCB Connector, ask for any Roland dealer nearby.

LOAD & PLAYBACK

■ Load

Writing sequencer data into the JSQ-60 is to be called "Load" in this manual.

Initially, connect the DCB cord to the DCB connector of the Juno-60 or Jupiter-8.





Set the Mode Switch to Play Only, then turn the JSQ-60 on. Here, 4/4 is automatically selected.

- * Changing the Mode Switch from the Tape mode to Play Only or Load/Play will automatically select 4/4.

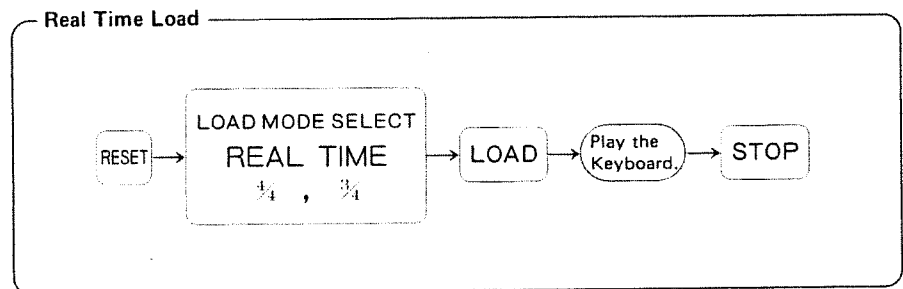
REAL TIME LOAD



If either of 4/4 or 3/4 mode is selected, what you play on the keyboard will be faithfully loaded into the sequencer.



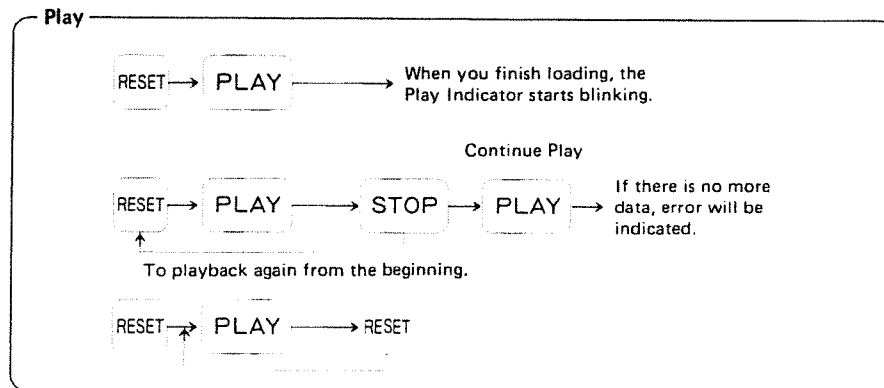

- (1) Set the Mode Switch to the LOAD/PLAY position (thus, Memory Protect function does not work).
 - * Be sure that the JSQ-60 is not running when changing the Mode Switch. Otherwise, the data will be erased.
- (2) Press the Reset Button, if the Load Indicator or Play Indicator is flashing.
- (3) Select either of Real time (4/4 or 3/4) with the Load Mode Selector Button .
- (4) By pushing the Load Button  on, turn the JSQ-60 into the writing mode. Metronome will start playing immediately, but there is no loading during the first measure of metronome. In other words, you should start playing the keyboard from the second measure of metronome.
- * The Load Indicator blinks in the same tempo as the metronome during the first measure.
- * If Full is indicated (all the Memory Indicators light up) during loading, the data stops automatically in the end of the measure. (If there are many notes before the end of the measure, it may stop even before.)
- (5) To stop loading, press the Stop Button . Loading will continue up to the last note of that measure then stop. (The Load Indicator starts blinking.)
- (6) If loading is completed, return the Mode Switch  to the Play Only position, so that the loaded data will be protected.

PLAY/REPEAT





- (1) Set the Mode Switch to PLAY ONLY or LOAD/PLAY.
- (2) Press the Reset Button  if the Load Indicator or Play Indicator flashes.
- (3) Pressing the Play Button  will light up the Play Indicator and start playing the data you have loaded. It automatically stops when the data is played up.

- * If you wish to stop in the middle of the playback, press the Stop Button . The playback will continue up to the last note of the measure, then the Play Indicator starts flashing. If you wish to

continue to playback, simply press the Play Button , but if there is no data following, error will be indicated.

Pressing the Reset Button in the middle of playback will stop playing. If you press the Play Button at this stage, the data will play from the beginning.

- * If you wish to repeat playing the same data, set the Repeat Play Switch  to ON, and press the Play Button, then the data will repeat playing until the Stop Button  or Reset Button  is pressed.

TEMPO/METRONOME

Metronome will be heard in Real Time Load or playback mode in quarter note intervals with an accent on the head of each measure.

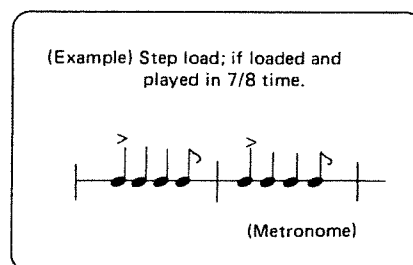

Before loading, set the tempo to an appropriate speed depending on the music you are to load. For instance, if you load a quick chord with the Tempo knob set to slow, and play it back in a quick tempo, its rhythm may prove somewhat unstable.

Monitoring Tempo

If you wish to see what the tempo of the metronome is actually like, set the Mode Switch to the PLAY ONLY or LOAD/PLAY position, and press the Stop button and Reset Button at the same time. It will stop by pressing the Stop Button . Here, the external device connected to the SYNC OUT does not work.

- * Metronome will have accents in the same places as the data lately loaded in real time. (4/4, if the data has been overdubbed, and no accent if there is no data written before.)

STEP LOAD

In this mode, only pitches can be written (i.e. timing values are the same throughout).

Three options ♪ , ♪^{3} and ♪ are available as a shortest timing value (1 step). By using the Tie, or Rest Button, even long tones, legato with star, or rest can be written.

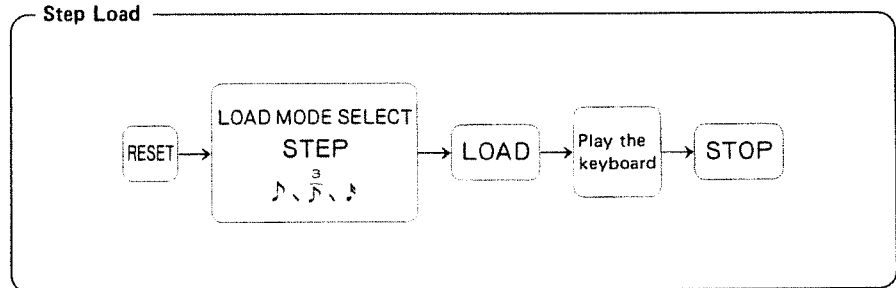

- (1) Find out the shortest note in the piece you are to write. Then represent the entire score with the shortest timing value.
- (2) Set the Mode Switch ⊗ to LOAD/PLAY (Memory Protect function is disabled).
- (3) Select a stop mode; ♪ , ♪^{3} or ♪ with the Load Mode Select Button Ⓜ .
- (4) Press the Load Button Ⓛ to turn the JSQ-60 into loading mode. Now, loading can start at any time.
 - * Each time a chord, a single note, or a rest is loaded, metronome will be heard once, advancing one step (when a bar line is written, a metronome with accent will sound once, but no step is advanced).
 - * How you play the keyboard does not affect the timing value of each note, i.e. all the notes will be written in the same length. What is important is pressing all the keys of the cord you wish to load at precisely the same time, and release all of them. The moment the keys are released, the pitches will be written. (If you have to load a chord which cannot be pressed at the same time, turn on the Hold Button on the Juno-60, and play each key one after another, then turn the Hold off.)
- (5) When loading is completed, press the Stop Button ⊗ .
- (6) Return the Mode Switch ⊗ to the PLAY ONLY position to protect the data you have loaded.

Example: If loading (in Step Load mode ♪)

Correct: Press → Release all the keys → Press → Release all the keys.

Wrong: Press → Press with being held down → Release all the keys.

will be loaded instead of)

Loading Pitches (in $\frac{3}{4}$ mode)

On releasing the keys, the chord is loaded.



Press them at precisely the same time → Release all keys → Metronome will be heard and the chord is loaded.

Repeat the same procedure four times.

* This will make a quarter note interval, costing 4 steps, so the metronome will sound with accent.

Loading Rests (in $\frac{3}{4}$ mode)

Pressing the Rest Button will load the shortest rest ($\frac{1}{4}$ if $\frac{3}{4}$ mode).
To load $\frac{1}{2}$, press the Rest Button four times.

Loading Tie (in $\frac{3}{4}$ mode)

Pressing the Tie Button will make the timing value one step longer.

If loading



Press them at precisely the same time → Release the keys → Press the Tie Button three times.

Special Use of the Tie Button (in $\frac{3}{4}$ mode)

1) Legato

Load the first note in a usual way and the next one by pressing a relevant key while holding the Tie Button down.

If loading



→ Release the key. → Press the Tie Button → Play D, E and F in non legato manner. → Release the Tie Button

Keep the Tie Button held down.

2) Tie + Legato

If loading

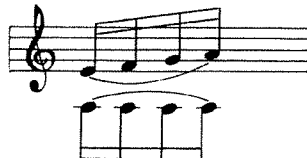

Modify the score as shown aside, then load in the same way as above.

■ **Measure End**

This is to load bar lines. Pressing the button will make a metronome sound, and a bar line will be loaded.

Please do not skip writing bar lines, or later editing would be very difficult.

■ **Step Value**

If the shortest timing value is ♯ (16th note), ♯ (quarter note) and ♯ (eighth note) can be replaced as shown below.

The shortest timing value is counted one step, so if ♯ = 1 step, ♯ = 2 steps and ♯ = 4 steps.

In this way, about 2000 notes (in single note) can be loaded into the JSQ 60. If the maximum Memory capacity is exceeded, the Memory Indicator Full will go on, and no more loading is possible. If you press the Load Button  at this stage, error will be indicated.

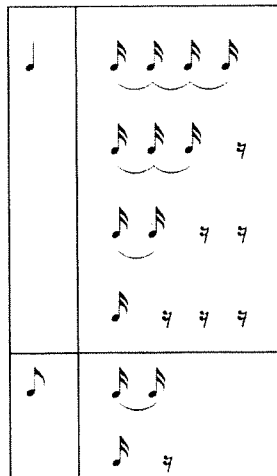

EDIT

Editing or adding data is possible by using Continue Load function. (Refer to "CONTINUE LOAD")

* In overdubbing mode, Continue Load function is not available.

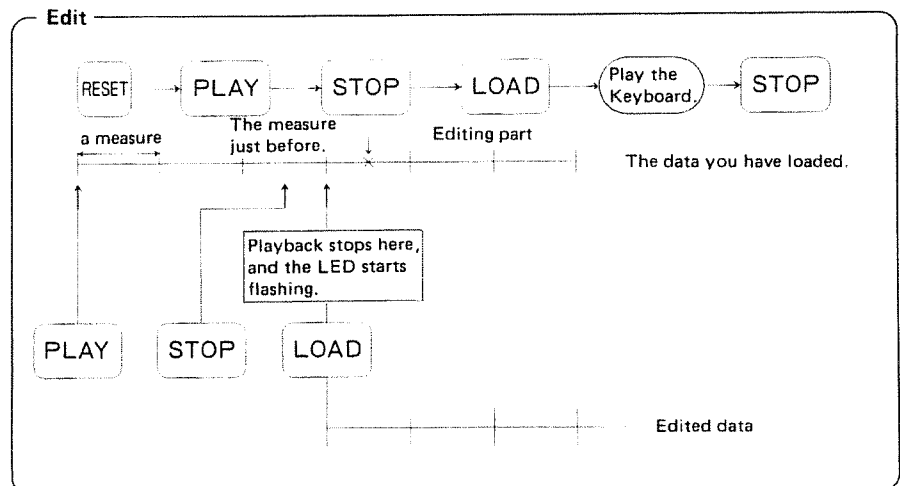

(1) Make sure that the Repeat Switch  is turned off.

(3) When it stops, select either 4/4 or 3/4 with the Load Mode Selector Button



(2) Playback the data and press the Stop Button  just before the measure that you wish to edit.

(4) Press the Load Button .

(5) Start loading correct data

Note: If the data you are to edit has been loaded in Step Load mode without bar lines, the data does not stop playing to the very end, even by pressing the Stop Button. So, it is not possible to edit the data in the middle, i.e. you have to rewrite the whole data.

CONTINUE LOAD

You can stop loading data by pressing the Stop Button , (the Load Indicator starts flashing) and continue loading simply by pressing the Load Button . Also, it is possible to stop playing data,

(the Play Indicator starts flashing) and start loading by pressing the Load Button . This function of the JSQ-60 is called Continue Load.

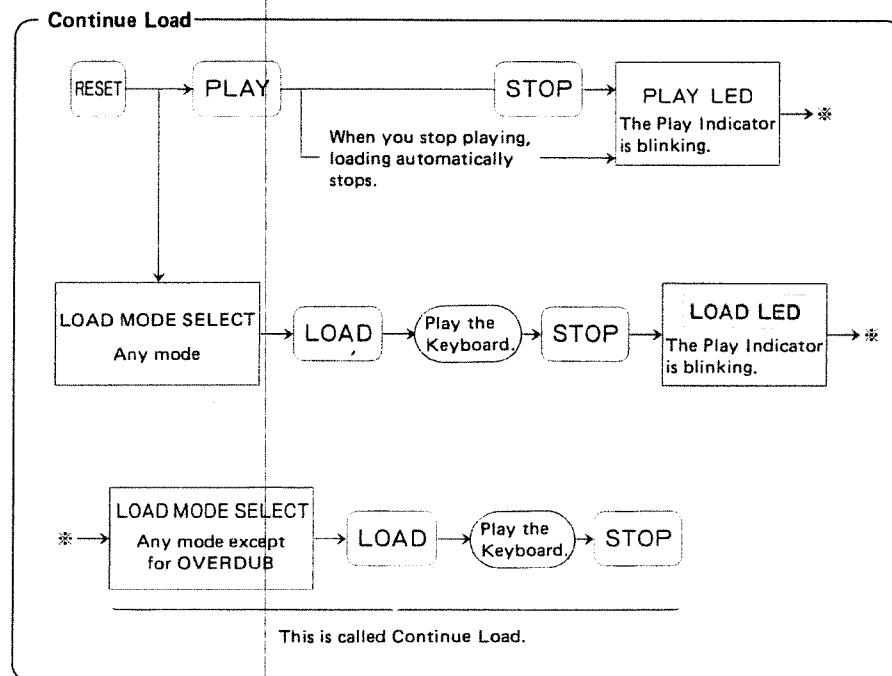

<Note>

- When the Memory Indicator shows FULL, Continue Load is not possible.
- In overdubbing, Continue Load is not possible, either.
- Exceeding the maximum memory capacity during Continue Load after playback or overdubbing will erase the existing data.



- If you start Continue Load in real time (4/4 or 3/4) after playback or overdubbing, the number in the Memory Indicator shows the amount of the data newly added. So you are required to work out how much capacity is left to load.

■ Application of Continue Load

- Combining two different Load Modes in loading.

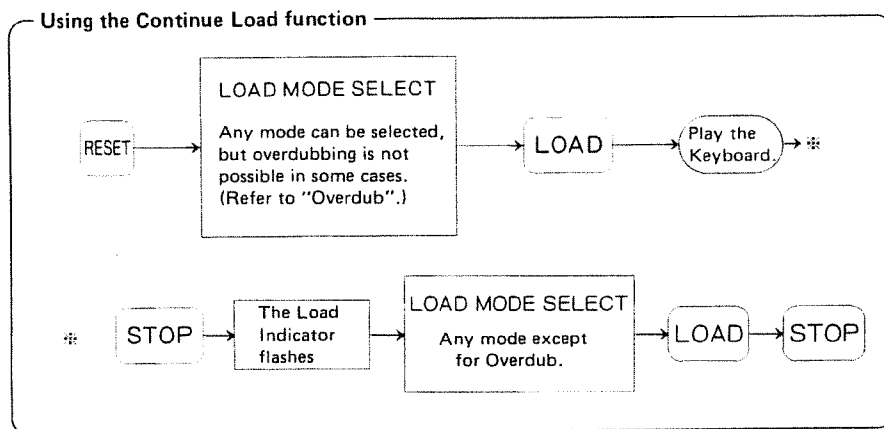
It is possible to load in one of the Load Modes, then continue loading in different Load Mode.



Note: If you stop playback or loading by pressing the Stop Button , the Load or Play Indicator will start flashing. This flashing means that you need to press the Reset Button  to go back to the beginning of the data.

OVERDUB

(Real Time)

It is possible to overdub a different phrase on the phrase you have already loaded.

* Overdubbing cannot be done other than in real time mode.

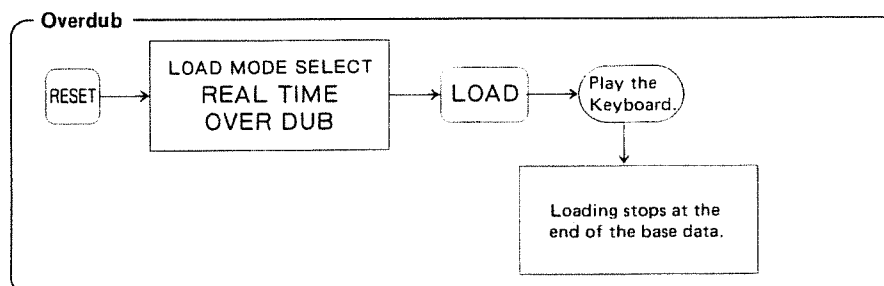

- (1) Select the OVER DUB mode in Real Time section by using the Load Mode Selector Button.
- (2) Press the Load Button , and begin playing the keyboard at the fifth metronome. Overdubbing is not possible before this.
- (3) Overdubbing automatically stops when it comes to the end of the base data, and the Load Indicator starts blinking, showing that loading is no longer possible.

< Note >

- Overdubbing can be done three times on one base data.
- The maximum notes that can be loaded into the JSQ-60 at a time is 6 by the Juno-60, and 8 by the Jupiter -8. If more notes are loaded, in later overdubbing or playback, noise may interfere.

- If the same note has been overdubbed on the base data, during playback, rhythm will change as shown below.

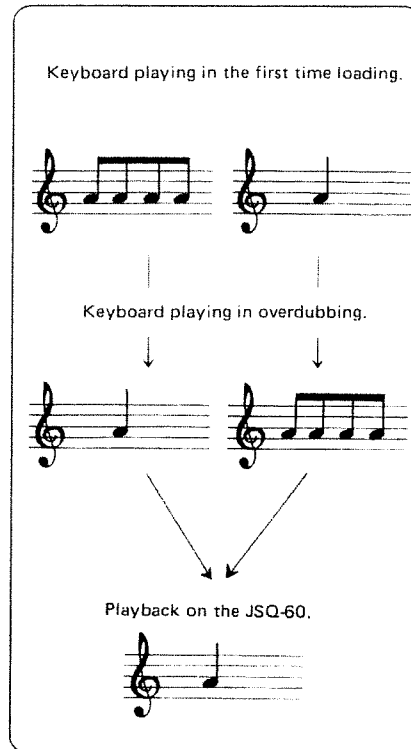

- Please note that if you stop overdubbing before the end of the base data (by pressing the Stop Button), the base data will also be cut short there. So, unless you specifically wish to make the data itself shorter, be sure to remain the overdubbing mode up to the very end, even if no more dubbing is currently needed.

- If Full is shown (all the Memory Indicators light up) during overdubbing, the data stops in the end of the measure (if there are many notes before the end of measure, it may stop even before), but then the following base data will not remain. Also, Memory indicators may change after this procedure.

- During overdubbing, the Memory Indicator may change even while you are not actually adding new data.

TAPE INTERFACE

The sequencer data you have loaded into the JSQ-60 can be saved onto an ordinary audio tape for storage and later retrieval.

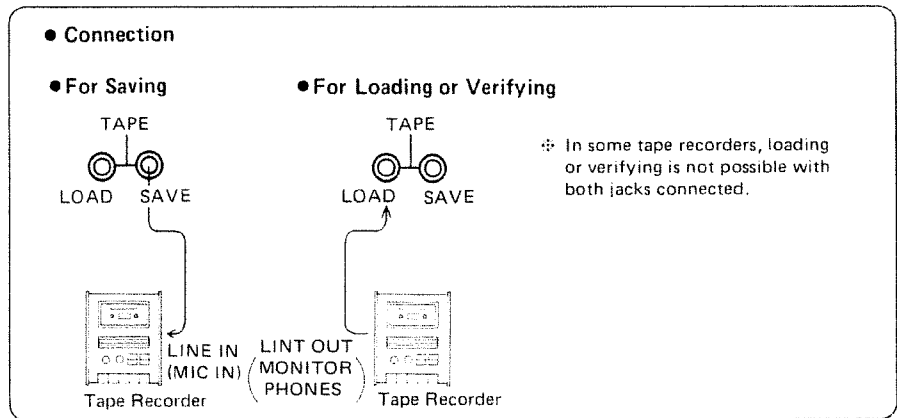

Verify function is featured for you to make sure if the data has been correctly saved.

- If the AC Adaptor is connected, turning the Power Switch off does not erase the data in memory, but in about a day after the AC Adaptor is disconnected, its data will be completely erased. So it may be a good idea to load all data onto a tape for precaution.





Set the Mode Switch  to the TAPE position.

SAVE

- (1) Set the tape recorder to the recording mode (REC).
 - * If your tape recorder features the recording level control, set the tape recorder to Recording Pause mode and set the recording level to about 0 VU, then turn the tape recorder to the recording mode.
- (2) Press the Save Button , and the Save Indicator lights up and the Pilot tone will change to a high tone. In about 5 seconds, saving will begin.
- (3) When saving is completed, metronome sound will be heard once and the Save Indicator will go out.
 - * To stop saving in the middle, simply press the Stop Button .
- (4) Stop the tape recorder.

VERIFY

- (1) Set the tape recorder so that the tape will start from the beginning of the data where Pilot Tone is still heard.
 - * Pilot Tone is a high pitch sound produced from the tape before it starts reading data.
- (2) Press the Verify Button , and the Verify Indicator will light up and verify will start.
- (3) Start playback on the tape recorder.
- (4) If a metronome sound is heard once and the Verify Indicator goes out, verify is completed.
 - * If there is any error, the Memory Indicator  will flash and metronome will start to sound (from now on, we call this "error indication").
 - * If you press the Stop Button  before verify is completed, it will stop with "error indication".
- (5) Stop the tape recorder.

If error is indicated

Rewind the tape and repeat verify procedure taking care of the following points.

- a) Be sure to rewind the tape thoroughly.
- b) Adjust the playback level of the tape recorder. (The appropriate level varies depending on the type of the tape recorder.)
- c) Make sure that the connections are all made correctly.

If verify did not complete even after 1 minute, repeat verify procedure, and if it still ends up with the same result, carefully repeat saving procedure.

If error is indicated again

Carefully repeat saving procedure.

If error is indicated again and again no matter how many times you try

- Replace with a new tape.
- Clean and demagnetize the head of the tape recorder.
- Use a different tape recorder and repeat saving procedure.

*** Preserving the Data tape**

Please do not keep the data recorded tape in extreme heat or humidity or near a strongly magnetic unit such as a speaker or an amplifier.

LOAD

(1) Set the tape recorder so that the tape will be played back from the beginning of the data.

- * If your tape recorder features a playback level control, set it to medium.

(2) Press the Load Button , and the Load Indicator will light up and loading will begin.

(3) Start playback on the tape recorder.

(4) When loading is completed, metronome will be heard once and the Load Indicator will light up. If loading is not done properly, error will be indicated.

- * If you press the Stop Button  in the middle of loading, loading will stop with error indication. In this case, the data in the JSQ's memory will be erased.

(5) If loading has been finished, stop the tape recorder.

If error is indicated

Repeat loading procedure taking care of the following points.

- Be sure to rewind the tape completely.
- Adjust the playback level of the tape recorder. (The appropriate level varies depending on the type of the tape recorder.)
- Make sure that the connections are all made correctly.

APPLICATION

PATCH SHIFT

The JSQ-60 can memorize the patch shift of the Juno-60.

■ **Real Time Load**

In this mode, Patch Shift information is loaded in real time, i.e., it is loaded exactly where you press the DP-2. In overdubbing, Patch Shift will be loaded as shown below.

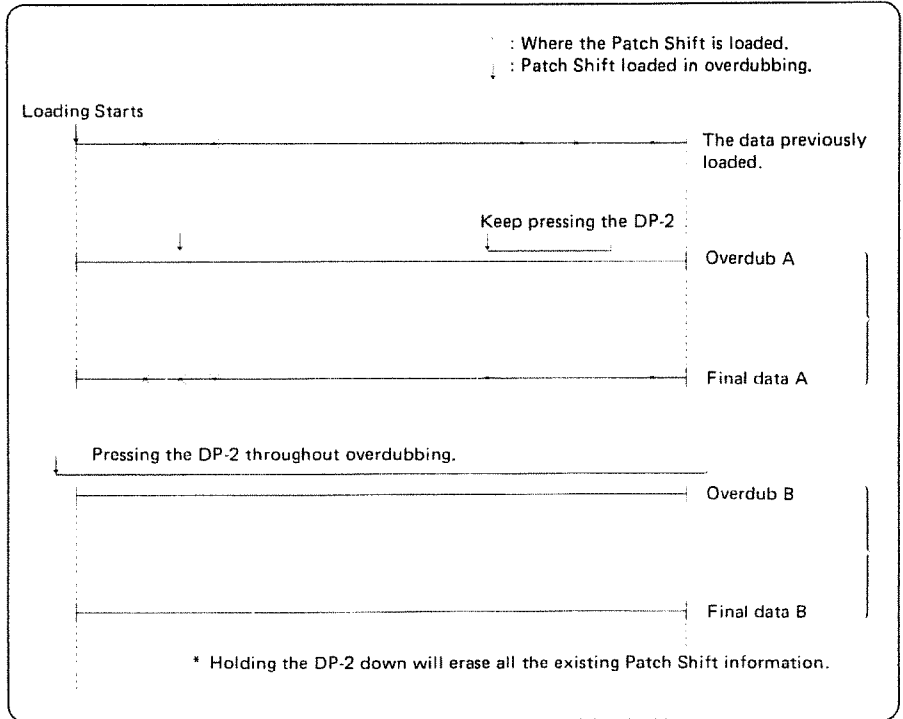

■ **Step Load**

Only one Patch Shift information is loaded in one step, and it is loaded into the step where the pedal is depressed.

■ **Playback**

Patch Shift is played back as it has been loaded.

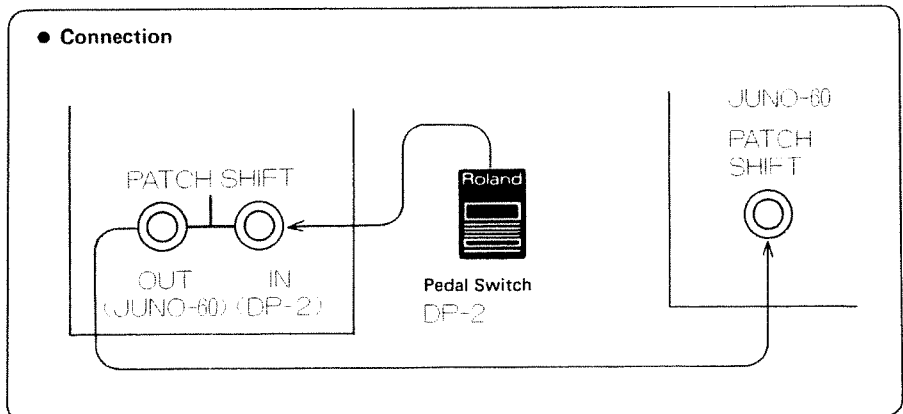

PATCH PRESET

Patch Preset information is sent from the JP-8 to the JSQ-60 through DCB. So it is possible to load Patch Presets on the JP-8

into the JSQ-60. (Juno-60 transmits only keyboard information.)

START/STOP

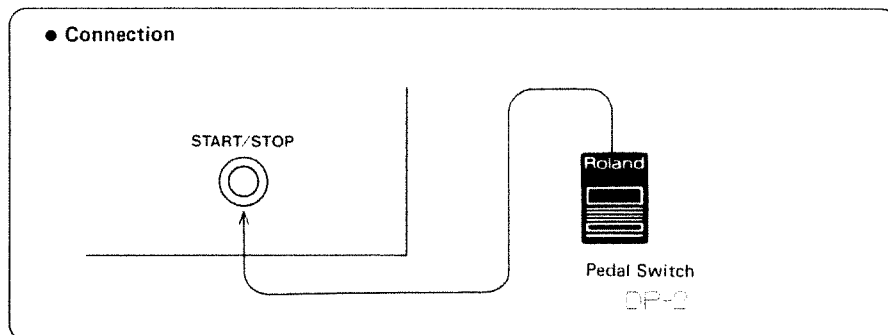

The Start/Stop Jack functions differently depending on the mode of the JSQ-60.

In Reset mode (while the Load and the Play Indicators remain dark)

This jack works just like the Play Button .

In Play mode

This jack works just like the Reset Button .

In Load mode (4/4, 3/4, OVER DUB)

This jack works just like the Stop Button .

SYNC

Use a DIN cord (5 Pin) for setting up an external device.

The JSQ-60 can control up to two devices which feature SYNC IN Jacks (DIN).

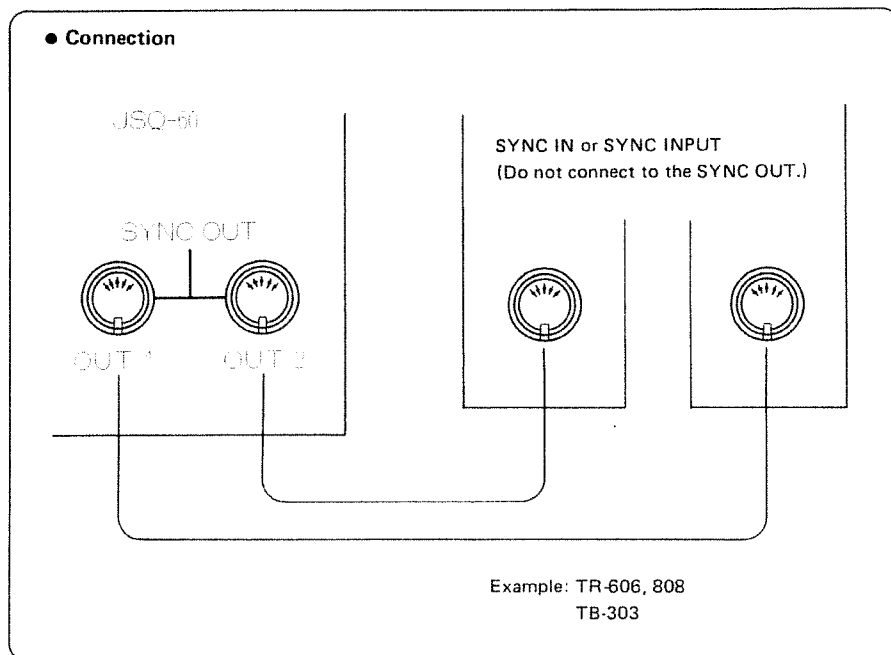





■ **Setting up with the MIDI BUS keyboard**

By using the MD-8 (MIDI ↔ DCB Interface), the JSQ-60 can be set up with the keyboard featuring MIDI BUS.

Note: Be sure to set the Function Switch on the MD-8 to MIDI ↔ DCB.

ERROR

If error is indicated (the Memory Indicator  blinks and metronome sounds), study the Error Table below.

Button pressed	Possible Cause	Action to be taken
Load Button	<ul style="list-style-type: none"> • The Mode Switch  is set to PLAY ONLY. • You are trying to overdub for the fourth time. • You are trying to overdub without resetting. • The Memory Indicator  shows FULL before starting Continue Load after playback. • The Memory Indicator  shows FULL before starting overdub. 	<ul style="list-style-type: none"> • Set the Mode Switch  to LOAD/PLAY. • Overdubbing is possible up to three times, so stop overdubbing. • Press the Reset Button. • There is no memory capacity left, so stop loading. • There is no memory capacity left, so stop overdubbing.
Stop Button	In Tape Mode <ul style="list-style-type: none"> • During verify • During loading (Data may break) 	<ul style="list-style-type: none"> • Refer to "VERIFY" on P.15. • Refer to "LOAD" on P.16.
Play Button	<ul style="list-style-type: none"> • Load Indicator is flashing. • When there is no data loaded. • The data is played up, and the play Indicator is flashing. 	<ul style="list-style-type: none"> • Press the Reset Button. • Load data. • Press the Reset Button.

* If no case above applies to yours, it is likely that the position of the Mode Switch is wrong. Refer to "Panel Description" on P. 5.

SPECIFICATIONS

■ JSQ-60 Digital Keyboard Recorder

Memory Capacity Approx. 2000 steps (in single notes)

Front Panel

Mode Switch (PLAY ONLY, LOAD/PLAY, TAPE)
Metronome Level Switch (HIGH, LOW, OFF)
Tempo Knob (♩ = 40 to 220)
Tempo Indicator
Reset/Tape Verify Button
Reset/Tape Verify Indicator
Load/Tape Load Indicator
Stop Button
Play/Tape Save Button
Play/Tape Save Indicator
Repeat Play Switch
Memory Consumption Indicator (25%, 50%, 75%, 90%, FULL)
Load Mode Selector Switch
 Real Time 4/4, 3/4, OVER DUB
 Step Load ♩, ♪, ♫
Load Mode Selector Indicator
 Real Time 4/4, 3/4, OVER DUB
 Step Load ♩, ♪, ♫
Tie Button
Rest Button
Measure End Button
Power Switch
Power Indicator

Rear Panel

DCB Connector
LOAD Jack (Tape Interface)
SAVE Jack (Tape Interface)
SYNC OUT (DIN) x 2
PATCH SHIFT OUT Jack
PATCH SHIFT IN Jack
START/STOP Jack
DC 9V IN (PSA Adaptor) Jack
Memory Data Keyboard (DCB), Patch Program Selection (DCB), Patch Shift (DP-2)

Others

Dimensions	226(W) x 223(D) x 57(H) mm / 8-7/8(W) x 8-3/4(D) x 2-1/4(H) in.
Weight	1.5 kg / 3 lb. 5 oz.
Power	9V DC, 70 mA
Consumption	3W
Accessory	AC Adaptor: PSA-120, 220 or 240

* Specifications are subject to change without notice.



 Roland®

10170

UPC

10170



10991

Roland

Free Manuals Download Website

<http://myh66.com>

<http://usermanuals.us>

<http://www.somanuals.com>

<http://www.4manuals.cc>

<http://www.manual-lib.com>

<http://www.404manual.com>

<http://www.luxmanual.com>

<http://aubethermostatmanual.com>

Golf course search by state

<http://golfingnear.com>

Email search by domain

<http://emailbydomain.com>

Auto manuals search

<http://auto.somanuals.com>

TV manuals search

<http://tv.somanuals.com>