

Roland Digital Piano **MP-500**
Owner's Manual

USING THE UNIT SAFELY 4
IMPORTANT NOTES 6
Main Features of the MP-500 7
Button Descriptions 8
Getting Started..... 10
 Connecting the Power Cord 10
 Opening and Closing the Lid 10
 About the Pedals 10
 Turning the Power On and Off 11
 Adjusting the Volume 11
 Setting the Music Stand 11
 Connecting Headphones 12
Listening to the Demo Songs..... 13
 Playing/Stopping the Demo Songs 13
 Selecting a Song for Playback 14
 List of Demo Songs..... 15
Playing the Keyboard 16
 Playing with Various Sounds 16
 Layering Two Instrument Sounds—Dual Play 16
 Using Two Different Sounds for Right And Left Hands—Split Function 17
 Adding Reverberation to the Sound—Reverb Effect 18
 Adding Breadth to the Sound—Chorus Effect..... 19
 Sounding the Metronome..... 20
Try Recording Your Performance 22
 Recording..... 22
 Listening to the Recorded Performance 24
 Deleting Recorded Songs..... 24
Convenient Functions..... 25
 Changing Keyboard Touch Sensitivity 25
 Transposing without Changing Your Fingering—Key Transpose 25
 Adjusting the Pitch of the Sound—Master Tuning 26
 Changing the Volume Balance in Dual Play 27
 Changing the Depth of the Reverb 27
 Changing the Depth of the Chorus 27
 Changing the Damper Pedal's Resonance 28
 Playing Songs Using Tunings from Classical Music 28
 Changing Tuning Curves 29
 Disabling Buttons—Panel Lock 30
Connecting to MIDI Devices..... 31
 About the MIDI Connectors 31
 Making the Connections 31
 Cautions when Connecting an External MIDI Device
 (Local On/Off and Omni On/Off)..... 32
 Set the MIDI Channel 33
 Transmitting/Receiving Sound Selection Data—Program Change 34
 Turning Transmission and Reception of Control Changes On/Off 35
 Transmitting Performance Data from MIDI Out 35
Connecting to Audio Equipment 36
Troubleshooting 37
Functions Assigned to the Keyboard 38
MIDI Implementation Chart..... 39
Specifications 40
Index 41

Before using this unit, carefully read the sections entitled: "IMPORTANT SAFETY INSTRUCTIONS" (p. 3), "USING THE UNIT SAFELY" (p. 4), and "IMPORTANT NOTES" (p. 6). These sections provide important information concerning the proper operation of the unit. Additionally, in order to feel assured that you have gained a good grasp of every feature provided by your new unit, Owner's manual should be read in its entirety. The manual should be saved and kept on hand as a convenient reference.

	CAUTION RISK OF ELECTRIC SHOCK DO NOT OPEN	
ATTENTION: RISQUE DE CHOC ELECTRIQUE NE PAS OUVRIR		
CAUTION: TO REDUCE THE RISK OF ELECTRIC SHOCK, DO NOT REMOVE COVER (OR BACK). NO USER-SERVICEABLE PARTS INSIDE. REFER SERVICING TO QUALIFIED SERVICE PERSONNEL.		



The lightning flash with arrowhead symbol, within an equilateral triangle, is intended to alert the user to the presence of uninsulated "dangerous voltage" within the product's enclosure that may be of sufficient magnitude to constitute a risk of electric shock to persons.



The exclamation point within an equilateral triangle is intended to alert the user to the presence of important operating and maintenance (servicing) instructions in the literature accompanying the product.

INSTRUCTIONS PERTAINING TO A RISK OF FIRE, ELECTRIC SHOCK, OR INJURY TO PERSONS.

IMPORTANT SAFETY INSTRUCTIONS SAVE THESE INSTRUCTIONS

WARNING - When using electric products, basic precautions should always be followed, including the following:

1. Read these instructions.
2. Keep these instructions.
3. Heed all warnings.
4. Follow all instructions.
5. Do not use this apparatus near water.
6. Clean only with a dry cloth.
7. Do not block any of the ventilation openings. Install in accordance with the manufacturers instructions.
8. Do not install near any heat sources such as radiators, heat registers, stoves, or other apparatus (including amplifiers) that produce heat.
9. Do not defeat the safety purpose of the polarized or grounding-type plug. A polarized plug has two blades with one wider than the other. A grounding type plug has two blades and a third grounding prong. The wide blade or the third prong are provided for your safety. When the provided plug does not fit into your outlet, consult an electrician for replacement of the obsolete outlet.
10. Protect the power cord from being walked on or pinched particularly at plugs, convenience receptacles, and the point where they exit from the apparatus.
11. Only use attachments/accessories specified by the manufacturer.
12. Never use with a cart, stand, tripod, bracket, or table except as specified by the manufacturer, or sold with the apparatus. When a cart is used, use caution when moving the cart/apparatus combination to avoid injury from tip-over. 
13. Unplug this apparatus during lightning storms or when unused for long periods of time.
14. Refer all servicing to qualified service personnel. Servicing is required when the apparatus has been damaged in any way, such as power-supply cord or plug is damaged, liquid has been spilled or objects have fallen into the apparatus, the apparatus has been exposed to rain or moisture, does not operate normally, or has been dropped.

For the U.K.

IMPORTANT: THE WIRES IN THIS MAINS LEAD ARE COLOURED IN ACCORDANCE WITH THE FOLLOWING CODE.

BLUE: NEUTRAL
BROWN: LIVE

As the colours of the wires in the mains lead of this apparatus may not correspond with the coloured markings identifying the terminals in your plug, proceed as follows:

The wire which is coloured BLUE must be connected to the terminal which is marked with the letter N or coloured BLACK.

The wire which is coloured BROWN must be connected to the terminal which is marked with the letter L or coloured RED.

Under no circumstances must either of the above wires be connected to the earth terminal of a three pin plug.

USING THE UNIT SAFELY

INSTRUCTIONS FOR THE PREVENTION OF FIRE, ELECTRIC SHOCK, OR INJURY TO PERSONS

About ⚠ WARNING and ⚠ CAUTION Notices

⚠ WARNING	Used for instructions intended to alert the user to the risk of death or severe injury should the unit be used improperly.
⚠ CAUTION	Used for instructions intended to alert the user to the risk of injury or material damage should the unit be used improperly. * Material damage refers to damage or other adverse effects caused with respect to the home and all its furnishings, as well to domestic animals or pets.

About the Symbols

	The ⚠ symbol alerts the user to important instructions or warnings. The specific meaning of the symbol is determined by the design contained within the triangle. In the case of the symbol at left, it is used for general cautions, warnings, or alerts to danger.
	The ⓧ symbol alerts the user to items that must never be carried out (are forbidden). The specific thing that must not be done is indicated by the design contained within the circle. In the case of the symbol at left, it means that the unit must never be disassembled.
	The ⚡ symbol alerts the user to things that must be carried out. The specific thing that must be done is indicated by the design contained within the circle. In the case of the symbol at left, it means that the power-cord plug must be unplugged from the outlet.

ALWAYS OBSERVE THE FOLLOWING





⚠ WARNING

- Before using this unit, make sure to read the instructions below, and the Owner's Manual.
- Do not open or perform any internal modifications on the unit.
- Do not attempt to repair the unit, or replace parts within it (except when this manual provides specific instructions directing you to do so). Refer all servicing to your retailer, the nearest Roland Service Center, or an authorized Roland distributor, as listed on the "Information" page.
- Never use or store the unit in places that are:
 - Subject to temperature extremes (e.g., direct sunlight in an enclosed vehicle, near a heating duct, on top of heat-generating equipment); or are
 - Damp (e.g., baths, washrooms, on wet floors); or are
 - Humid; or are
 - Exposed to rain; or are
 - Dusty; or are
 - Subject to high levels of vibration.
- Make sure you always have the unit placed so it is level and sure to remain stable. Never place it on stands that could wobble, or on inclined surfaces.
- The unit should be connected to a power supply only of the type described in the operating instructions, or as marked on the rear of unit.
- Use only the attached power-supply cord.





⚠ WARNING

- Do not excessively twist or bend the power cord, nor place heavy objects on it. Doing so can damage the cord, producing severed elements and short circuits. Damaged cords are fire and shock hazards!
- This unit, either alone or in combination with an amplifier and headphones or speakers, may be capable of producing sound levels that could cause permanent hearing loss. Do not operate for a long period of time at a high volume level, or at a level that is uncomfortable. If you experience any hearing loss or ringing in the ears, you should immediately stop using the unit, and consult an audiologist.
- Do not allow any objects (e.g., flammable material, coins, pins); or liquids of any kind (water, soft drinks, etc.) to penetrate the unit.
- Immediately turn the power off, remove the AC adaptor from the outlet, and request servicing by your retailer, the nearest Roland Service Center, or an authorized Roland distributor, as listed on the "Information" page when:
 - The AC adaptor, the power-supply cord, or the plug has been damaged; or
 - If smoke or unusual odor occurs
 - Objects have fallen into, or liquid has been spilled onto the unit; or
 - The unit has been exposed to rain (or otherwise has become wet); or
 - The unit does not appear to operate normally or exhibits a marked change in performance.







WARNING

- In households with small children, an adult should provide supervision until the child is capable of following all the rules essential for the safe operation of the unit. 
- Protect the unit from strong impact. (Do not drop it!) 
- Do not force the unit's power-supply cord to share an outlet with an unreasonable number of other devices. Be especially careful when using extension cords—the total power used by all devices you have connected to the extension cord's outlet must never exceed the power rating (watts/amperes) for the extension cord. Excessive loads can cause the insulation on the cord to heat up and eventually melt through. 
- Before using the unit in a foreign country, consult with your retailer, the nearest Roland Service Center, or an authorized Roland distributor, as listed on the "Information" page. 
- Do not put anything that contains water (e.g., flower vases) on this unit. Also, avoid the use of insecticides, perfumes, alcohol, nail polish, spray cans, etc., near the unit. Swiftly wipe away any liquid that spills on the unit using a dry, soft cloth. 

CAUTION

- The unit should be located so that its location or position does not interfere with its proper ventilation. 
- Always grasp only the plug on the power-supply cord when plugging into, or unplugging from, an outlet or this unit. 
- At regular intervals, you should unplug the power plug and clean it by using a dry cloth to wipe all dust and other accumulations away from its prongs. Also, disconnect the power plug from the power outlet whenever the unit is to remain unused for an extended period of time. Any accumulation of dust between the power plug and the power outlet can result in poor insulation and lead to fire. 
- Try to prevent cords and cables from becoming entangled. Also, all cords and cables should be placed so they are out of the reach of children. 
- Never climb on top of, nor place heavy objects on the unit. 

CAUTION

- Never handle the power cord or its plugs with wet hands when plugging into, or unplugging from, an outlet or this unit. 
- If you need to move the instrument, take note of the precautions listed below. At least two persons are required to safely lift and move the unit. It should be handled carefully, all the while keeping it level. Make sure to have a firm grip, to protect yourself from injury and the instrument from damage. 
 - Check to make sure the knob bolts securing the unit to the stand have not become loose. Fasten them again securely whenever you notice any loosening.
 - Disconnect the power cord.
 - Disconnect all cords coming from external devices.
 - Raise the adjusters on the stand (p. 10).
 - Close the lid.
 - Remove the music stand.
- Before cleaning the unit, turn off the power and unplug the power cord from the outlet (p. 10). 
- Whenever you suspect the possibility of lightning in your area, pull the plug on the power cord out of the outlet. 
- Be careful when opening/closing the lid so you do not get your fingers pinched (p. 10). Adult supervision is recommended whenever small children use the unit. 
- Should you remove the screws fastening the stand, make sure to put them in a safe place out of children's reach, so there is no chance of them being swallowed accidentally. 

IMPORTANT NOTES

In addition to the items listed under “IMPORTANT SAFETY INSTRUCTIONS” and “USING THE UNIT SAFELY” on pages 3, 4 and 5, please read and observe the following:

Power Supply

- Do not use this unit on the same power circuit with any device that will generate line noise (such as an electric motor or variable lighting system).
- Before connecting this unit to other devices, turn off the power to all units. This will help prevent malfunctions and/or damage to speakers or other devices.
- Although the LCD and LEDs are switched off when the POWER switch is switched off, this does not mean that the unit has been completely disconnected from the source of power. If you need to turn off the power completely, first turn off the POWER switch, then unplug the power cord from the power outlet. For this reason, the outlet into which you choose to connect the power cord's plug should be one that is within easy reach.

Placement

- Using the unit near power amplifiers (or other equipment containing large power transformers) may induce hum. To alleviate the problem, change the orientation of this unit; or move it farther away from the source of interference.
- This device may interfere with radio and television reception. Do not use this device in the vicinity of such receivers.
- Noise may be produced if wireless communications devices, such as cell phones, are operated in the vicinity of this unit. Such noise could occur when receiving or initiating a call, or while conversing. Should you experience such problems, you should relocate such wireless devices so they are at a greater distance from this unit, or switch them off.
- Do not expose the unit to direct sunlight, place it near devices that radiate heat, leave it inside an enclosed vehicle, or otherwise subject it to temperature extremes. Also, do not allow lighting devices that normally are used while their light source is very close to the unit (such as a piano light), or powerful spotlights to shine upon the same area of the unit for extended periods of time. Excessive heat can deform or discolor the unit.
- When moved from one location to another where the temperature and/or humidity is very different, water droplets (condensation) may form inside the unit. Damage or malfunction may result if you attempt to use the unit in this condition. Therefore, before using the unit, you must allow it to stand for several hours, until the condensation has completely evaporated.
- Do not allow rubber, vinyl, or similar materials to remain on the piano for long periods of time. Such objects can discolor or otherwise harmfully affect the finish.
- Do not allow objects to remain on top of the keyboard. This can be the cause of malfunction, such as keys ceasing to produce sound.

- Do not paste stickers, decals, or the like to this instrument. Peeling such matter off the instrument may damage the exterior finish.

Maintenance

- To clean the unit, use a dry, soft cloth; or one that is slightly dampened. Try to wipe the entire surface using an equal amount of strength, moving the cloth along with the grain of the wood. Rubbing too hard in the same area can damage the finish.
- Never use benzine, thinners, alcohol or solvents of any kind, to avoid the possibility of discoloration and/or deformation.
- The pedals of this unit are made of brass. Brass eventually darkens as the result of the natural oxidization process. If the brass becomes tarnished, polish it using commercially available metal polisher.

Additional Precautions

- Use a reasonable amount of care when using the unit's buttons, sliders, or other controls; and when using its jacks and connectors. Rough handling can lead to malfunctions.
- When connecting / disconnecting all cables, grasp the connector itself—never pull on the cable. This way you will avoid causing shorts, or damage to the cable's internal elements.
- A small amount of heat will radiate from the unit during normal operation.
- To avoid disturbing your neighbors, try to keep the unit's volume at reasonable levels. You may prefer to use headphones, so you do not need to be concerned about those around you (especially when it is late at night).
- When you need to transport the unit, pack it in shock-absorbent material. Transporting the unit without doing so can cause it to become scratched or damaged, and could lead to malfunction.
- Do not apply undue force to the music stand while it is in use.
- Use a cable from Roland to make the connection. If using some other make of connection cable, please note the following precautions.
 - Some connection cables contain resistors. Do not use cables that incorporate resistors for connecting to this unit. The use of such cables can cause the sound level to be extremely low, or impossible to hear. For information on cable specifications, contact the manufacturer of the cable.

Main Features of the MP-500

Authentic piano performances

High-quality concert grand piano tones, combined with the Progressive Hammer Action keyboard, which provides more realistic piano touch, with a heavier feel in the low end and a lighter feel in the upper notes, let you enjoy truly authentic piano performances.

- **Captures the brilliant resonance**

The sound of a grand piano has a more brilliant timbre than that of an upright piano. This is because the sound of a grand piano contains a greater amount of high-frequency components. The piano sounds of the MP-500 reproduce this characteristic of the grand piano.

- **Reproduces the extended high-frequency response**

One of the features of the acoustic piano is that for the approximately one and a half octaves at the top of the range, there is no damper to restrict the vibration of the strings. This allows the vibration of the string to continue whether or not the damper pedal is pressed. Since this also allows these strings to vibrate sympathetically with other strings, they can sometimes be heard sounding independently from the low and middle-register strings.

The MP-500 faithfully simulates these characteristics of the acoustic piano.

Nine tones for use in a wide variety of musical genres

The MP-500 features not only piano tones, but nine different internal tones that you can use in a variety of musical genres (8 tones + 1 tone [in Split mode]).

Three metronome sounds

The MP-500 provides a metronome that lets you use three different sounds. You can easily adjust the tempo and time.

Record your own performances

The MP-500 makes it easy to record your own performances.

Button Descriptions



Button, switch and knob names are enclosed in square brackets ([]).

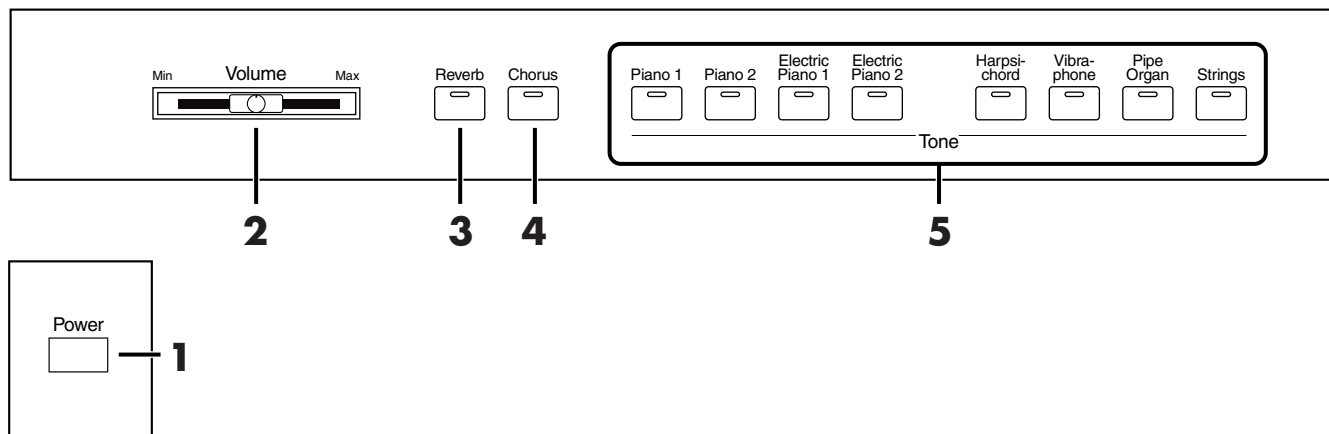

1 [Power] Switch

Pressed to switch the power on and off (p. 11).

2 [Volume] Slider

Adjusts the overall volume (p. 11).

3 [Reverb] Button

Used to add reverberation to the sound (p. 18).

4 [Chorus] Button

Adds the Chorus Effect to the sound (p. 19).

5 Tone Buttons

The following eight buttons are collectively referred to as the Tone buttons. These are used to select the tone to played via the keyboard (p. 16).

[Piano 1] Button

[Piano 2] Button

[Electric Piano 1] Button

[Electric Piano 2] Button

[Harpsichord] Button

[Vibraphone] Button

[Pipe Organ] Button

[Strings] Button

By holding down three of these buttons while you then press a specific key, you can make various settings on the MP-500.

→ "Functions Assigned to the Keyboard" (p. 38)

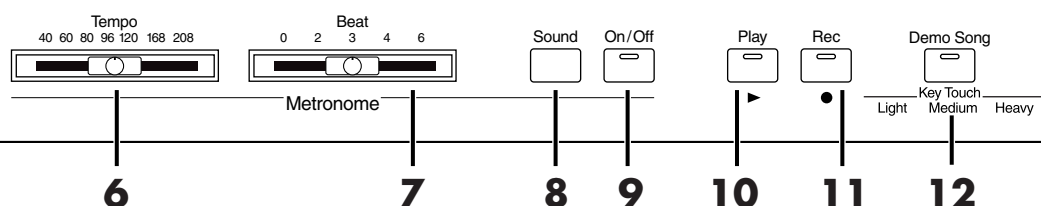

6 Metronome [Tempo] Slider

This adjusts the tempo of the metronome (p. 21).

7 Metronome [Beat] Slider

Used to select the time of the metronome (p. 21).

8 Metronome [Sound] Button

This is used to change the metronome sound (p. 21).
This button is also used in setting the Split function (p. 17).

9 Metronome [On/Off] Button

Activates the built-in metronome (p. 20).

10 [Play] Button

This starts and stops the demo songs, or a recorded performance (p. 13, p. 24).
It also is used to start/stop recording (p. 22).

11 [Rec] Button

Press this button to put MP-500 in recording standby (p. 22).

12 [Demo Song/Key Touch] Button

This plays the demo songs (p. 13).
By holding down this button while you then press a specific key, you can change the touch sensitivity (p. 25) or make various settings on the MP-500.
→ "Functions Assigned to the Keyboard" (p. 38)

Getting Started

Connecting the Power Cord

NOTE

To prevent malfunction and/or damage to speakers or other devices, always turn down the volume, and turn off the power on all devices before making any connections.

1. Connect the supplied power cable to the AC Inlet on the rear panel of the MP-500.
2. Connect the power cable to an AC outlet.

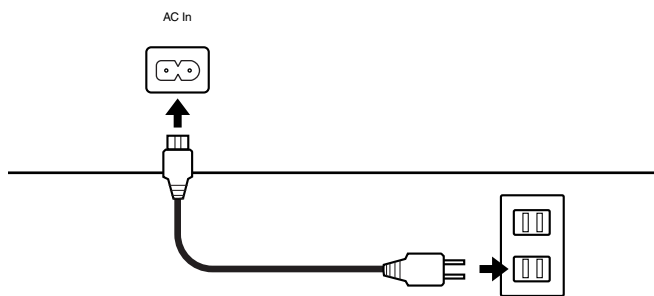

Opening and Closing the Lid

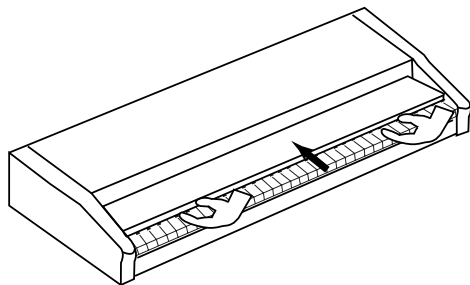

1. When opening the MP-500's lid, grasp the lid with both hands and gently lift it upwards, then slide it towards the back of the piano.
2. When closing the lid, slowly pull the lid forward, then gently lower it into place.

Do not insert your hands into the inside of the piano through the space between the lid and the keyboard.

NOTE

Take care not to allow fingers to be caught or pinched when opening and closing the lid. Make sure an adult is on hand to provide assistance when young children are playing the MP-500.

NOTE

For safety, transport the keyboard only with the lid in the closed position.

About the Pedals

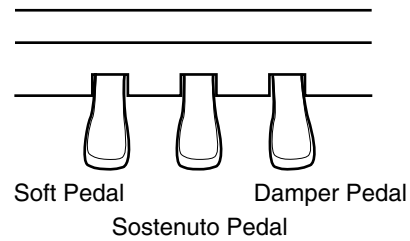

Soft Pedal

This pedal softens the sound.

Playing with the soft pedal depressed produces a sound that is not as strong as when otherwise played with the equivalent strength.

Sostenuto Pedal

With the sostenuto pedal, only the sound played at the moment the pedal is pressed is sustained.

Damper Pedal

Use this pedal when you want the sound to linger.

While the damper pedal is depressed, the sound from the keyboard continues to linger/remain for an extended period, even when you remove your fingers from the keys.

On acoustic pianos, when the damper pedal is depressed, additional strings are released to resonate with the sound of the keys that have been played, adding richness and breadth to the sound. The damper pedal on the MP-500 recreates this resonance when depressed. This resonance is called "Sympathetic Resonance."

MEMO

You can change the amount of resonance applied with the damper pedal. For more information and instructions, please refer to "Changing the Damper Pedal's Resonance" (p. 28).

About the Adjuster

After you have moved this piano, or when you feel it is unbalanced, lower the adjuster at the bottom of the pedal board as follows:

- Lower the adjuster so that it is firmly in contact with the floor. If there is a gap between the adjuster and the floor, the unit may malfunction when the pedal is pressed. In particular when the instrument is placed on a carpeted floor, you must lower the adjuster so that it presses strongly against the floor.

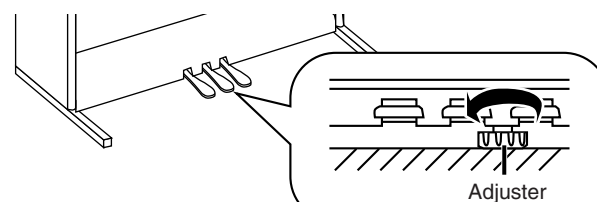

Turning the Power On and Off

NOTE

Once the connections have been completed, turn on power to your various devices in the order specified. By turning on devices in the wrong order, you risk causing malfunction and/or damage to speakers and other devices.

■ Turning on the power

1. Before you switch on the power, turn the volume all the way down by using the [Volume] slider.

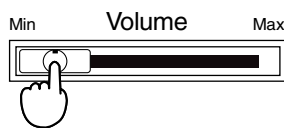

2. Press the [Power] switch, to turn on the power.

Lower position



After a few seconds, the keyboard will produce sound when played. Adjust the volume appropriately.

NOTE

This unit is equipped with a protection circuit. A brief interval (a few seconds) after power up is required before the unit will operate normally.

■ Turning off the power

1. Before switching the power off, turn the volume all the way down by using the [Volume] slider.

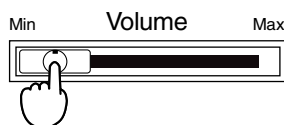

2. Press the [Power] switch, to turn off the power.

Upper position



The power is turned off.

Adjusting the Volume

Use the [Volume] slider to adjust the overall volume.

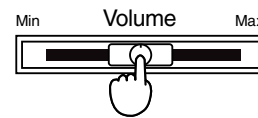

Setting the Music Stand

Insert the music stand into the two holes as shown in the figure below.

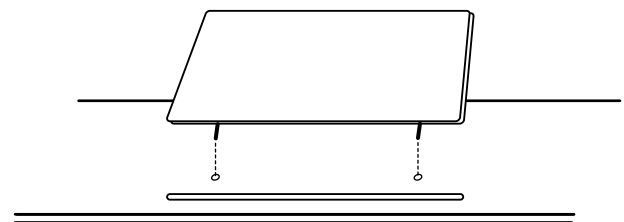

NOTE

Before moving the MP-500, be sure to remove the music stand as a safety precaution.

Connecting Headphones

The MP-500 features two headphone jacks. This allows two people to listen through headphones simultaneously, making it very useful for lessons and when performing piano pieces for four hands. Additionally, this allows you to play without having to worry about bothering others around you, even at night.

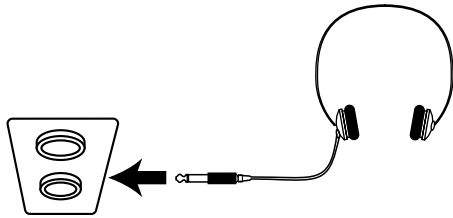

- 1. Turn the volume all the way down by using the [Volume] slider.**
- 2. Plug the headphones into the Phones jack on the lower-left panel of the MP-500.**
- 3. Use the [Volume] slider to adjust the volume of the headphones.**

This switches off the MP-500 speakers. Sound will be heard only through the headphones.

NOTE

Please use stereo headphones.

● **Precautions to take when using headphones**

- To avoid damaging or severing the headphone cord, be sure to handle the headphones by holding the phones themselves, and grasping the plug and not the cord when pulling the headphone plug.
- Connecting the headphones when the volume of connected equipment is turned up may result in damage to the headphones. Connect the headphones only after turning the volume down completely.
- Listening at excessively high volume levels will not only damage the headphones, but may also cause hearing loss. Listen at appropriate levels.

Listening to the Demo Songs

The MP-500 features thirty two internal piano songs.

Playing/Stopping the Demo Songs

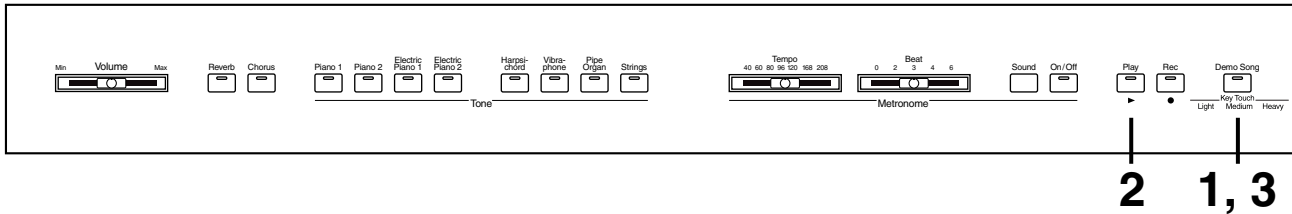

- 1. Press the [Demo Song/Key Touch] button, and confirm that the indicator has lit.**

The [Play] button's indicator starts blinking.

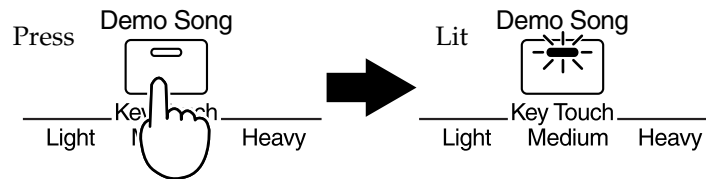

- 2. Press the [Play] button, and the indicator will change from blinking to lit.**

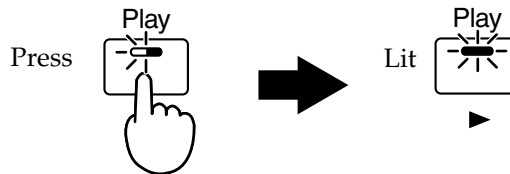

The demo songs will play back in succession, starting with the first song. When the last song has been played, playback will return to the first song and begin again.

- 3. To stop the demo song playback, press the [Demo Song/Key Touch] button to make the indicator go out.**

The demo song playback will stop.

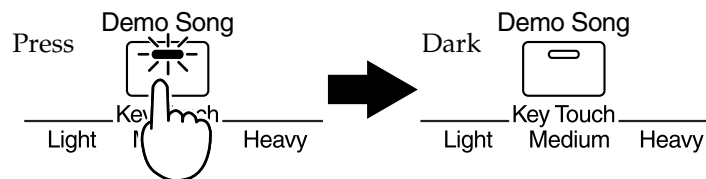

You can also stop demo song playback by pressing the [Play] button or [Rec] button. In this case, the [Demo Song/Key Touch] button indicator will not be extinguished. When you press the [Play] button next the demo will resume playing from the beginning of the song where playback was halted.

NOTE It is not possible to change the tempo of a demo song.

NOTE If you press the [Demo Song/Key Touch] button while the metronome is sounding (p. 20), the metronome will stop sounding. It is not possible to sound the metronome while a demo song is playing.

Selecting a Song for Playback

Here's how you can select and play a desired demo song.

While holding down the [Demo Song/Key Touch] button, and press the Tone button that corresponds to the demo song you wish to hear.

Four demo songs are assigned to each one of the Tone buttons. While holding down the [Demo Song/Key Touch] button, press a relevant button enough times to select the song you want, while cycling through the four song choices available at that button.

For example, to play back from song "1-3," hold down the [Demo Song/Key Touch] button and press the [Piano 1] button three times.

If you are already playing back song "1-1," hold down the [Demo Song/Key Touch] button and press the [Piano 1] button two times to play Song "1-3."

Piano 1	Piano 2	Electric Piano 1	Electric Piano 2	Tone			
1-1	2-1	3-1	4-1	5-1	6-1	7-1	8-1
1-2	2-2	3-2	4-2	5-2	6-2	7-2	8-2
1-3	2-3	3-3	4-3	5-3	6-3	7-3	8-3
1-4	2-4	3-4	4-4	5-4	6-4	7-4	8-4

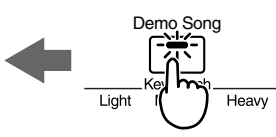

While holding down...



Press the button corresponding to the song number

The indicators of the [Demo Song/Key Touch] button and the [Play] button will light. The demo songs will play back consecutively, starting with the song you selected. When the last song has been played, playback will return to the first song and resume.

Subsequent demo songs are automatically played one after another until you stop them playing.

■ List of Demo Songs

No.	Title	Composer	Copyright
1-1	Intro	J. Maul	© 1991, 1999 Roland UK
1-2	Je Te Veux	E. Satie	© 1997 Roland Corporation
1-3	Golliwog's Cakewalk	C. Debussy	© 1996 Roland Corporation
1-4	"Fröhlicher Landmann" from "Album Für Die Jugend" Op. 68	R. Schumann	© 1996 Roland Corporation
2-1	Bagatelle "Für Elise" WoO. 59	L. v. Beethoven	© 1994 Roland Corporation
2-2	Arabesque No. 1 in E-Major	C. Debussy	© 1994 Roland Corporation
2-3	Salut D'Amour Op. 12	E. Elgar	© 1996 Roland Corporation
2-4	"Troika Drive: November" from "The Seasons," Op. 37	P. Tchaikovsky	© 1996 Roland Corporation
3-1	A Maiden's Prayer	T. Badarzewska	© 1996 Roland Corporation
3-2	"Promenade" from "Tableaux d'une exposition"	M. Musorgsky	© 1995 Roland Corporation
3-3	On Wings Of Song	F. Mendelssohn	© 1996 Roland Corporation
3-4	Moment musicaux No. 3, Op. 94-3	F. Schubert	© 1994 Roland Corporation
4-1	No. 14 "La Styrienne" from "25 Easy Studies" Op. 100"	F. Burgmüller	© 1992 Roland Corporation
4-2	Türkisch March (Piano Sonate No. 11 in A Major, 3rd Movement "Alla Turca")	W. A. Mozart	© 1994 Roland Corporation
4-3	Rondo Brillante "Aufforderung Zum Tanz" in D-flat Major, Op. 65"	C. M. v. Weber	© 1994 Roland Corporation
4-4	"Frühlingslied" from "Lieder Ohne Worte Heft 5," Op. 62-6	F. Mendelssohn	© 1996 Roland Corporation
5-1	Cantata BWV. 147 (Jazz Arranged)	J. S. Bach / Naoki Nishi	© 1993 Roland Corporation
5-2	Gymnopedie No. 1	E. Satie	© 1997 Roland Corporation
5-3	Fantasia-Impromptu Op.66	F. Chopin	© 1994 Roland Corporation
5-4	Etude No. 5 in G-flat Major "Black Keys," Op. 10-5	F. Chopin	© 1990 Roland Corporation
6-1	Etude No.3 in E Major "Chanson De L'Adieu," Op. 10-3	F. Chopin	© 1992 Roland Corporation
6-2	Mazurka No.5 in B-flat Major, Op. 7-1	F. Chopin	© 1995 Roland Corporation
6-3	Valse No. 6 in D-flat Major, Op. 64-1 "Petit Chien"	F. Chopin	© 1990 Roland Corporation
6-4	Nocturne No. 2 in E-flat Major, Op. 9-2	F. Chopin	© 1993 Roland Corporation
7-1	Fly Free	J. Maul	© 1992 Roland Corporation
7-2	Piano Sonata No. 14 in C-sharp Minor, "Moonlight" 1st Movement	L. v. Beethoven	© 1998 Roland Corporation
7-3	"Berceuse" from "Dolly," Op. 56	G. Fauré	© 1995 Roland Corporation
7-4	Slavonic Dance No. 10, Op. 72-2	A. Dvořák	© 1998 Roland Corporation
8-1	Mood/Ending	J. Maul	© 1991, 1999 Roland UK
8-2	3-Romances Sans Paroles No. 3, Op. 17	G. Fauré	© 1996 Roland Corporation
8-3	"Clair de lune" from "Suite Bergamasque"	C. Debussy	© 1990 Roland Corporation
8-4	"Träumerei" from "Scenes From Childhood" Op. 15	R. Schumann	© 1997 Roland Corporation

* All rights reserved. Unauthorized use of this material for purposes other than private, personal enjoyment is a violation of applicable laws.

* No data for the music that is played will be output from MIDI OUT.

Profiles of Composers

John Maul

John Maul is a musician, composer and arranger having graduated from the Royal Academy of Music in London. John's work encompasses studio recordings and live performances including work with top UK Jazz artists. His writing credits include commercial music for BBC radio and television, as well as scoring jazz and classical works.

Having been a product specialist for Roland U.K., John is now actively involved in music software composing/programming for both Roland Japan and various music publishers. Quite recently his "Musical Picture Book," a volume of original piano music encompassing all standards of musical ability, which included the piano and orchestral accompaniment data in SMF format, was published and printed.

Naoki Nishi

Born in 1958 in Hiroshima, Japan. Began working professionally at the age of 21. Has so far released 9 albums on which he is featured. He has also taken part in numerous other albums. His broad range of activities have included appearances at a number of jazz festivals in Japan and other parts of the world. In addition to his duties as an instructor at the Tokyo Conservatoire Shoubi, he has provided his services as a demonstrator for Roland since 1990. He is considered to be one of Japan's finest jazz pianist.

Playing the Keyboard

Playing with Various Sounds

The MP-500 allows you to play using eight different sounds including piano.

The MP-500's sounds are called "Tones."

Use the eight Tone buttons to select tones.

When the MP-500 is turned on, the tone is reset to "Piano 1."

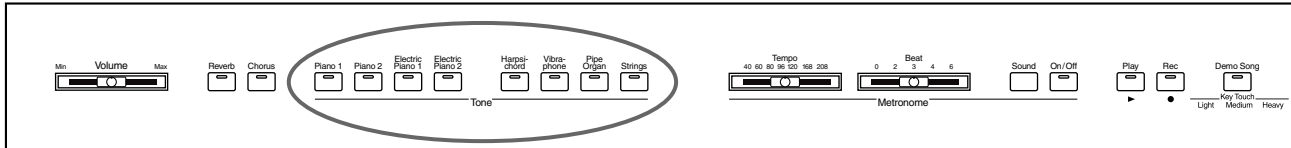

Press any Tone button and confirm that its indicator is lit.

When you play the keyboard, the selected tone is played.

Tone Name	Description
Piano 1	Full-sized Concert Grand Piano Rich stereo sound, providing 32 polyphonic notes.
Piano 2	Full-sized Concert Grand Piano 64 polyphonic notes
Electric Piano 1	Sound of a Rhodes piano
Electric Piano 2	A synthesizer's electric piano
Harpsichord	Delicate and elegant harpsichord sound
Vibraphone	The sound of a resonant vibraphone
Pipe Organ	A stately pipe organ sound
Strings	An ensemble of string instruments

Layering Two Instrument Sounds—Dual Play

Playing with two different tones on the keyboard simultaneously is called "Dual Play."

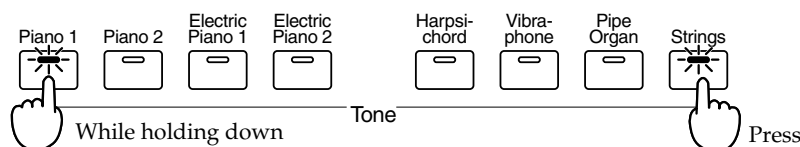

1. While holding down the [Piano 1] button, press the [Strings] button.

The indicators on the two Tone buttons you have pressed will light, and both of the Tones will be heard when you play the keyboard.

In this way, you can hold down one Tone button and press another Tone button to layer two sounds for playing together.

2. To cancel the Dual Play, press any Tone button.

When you play the keyboard, only the sound of the button you pressed will be heard.



You can adjust the volume balance between the two selected tones in Dual Play.
Please refer to "Changing the Volume Balance in Dual Play" (p. 27).

Using Two Different Sounds for Right And Left Hands—Split Function

The piano allows you to divide the keyboard into two sections, upper and lower, and to play two different Tones. Dividing the keyboard is called “Split” and the key where the keyboard is split is called the “Split Point.”

The Split Point is at “F # 3” when the power is turned on.

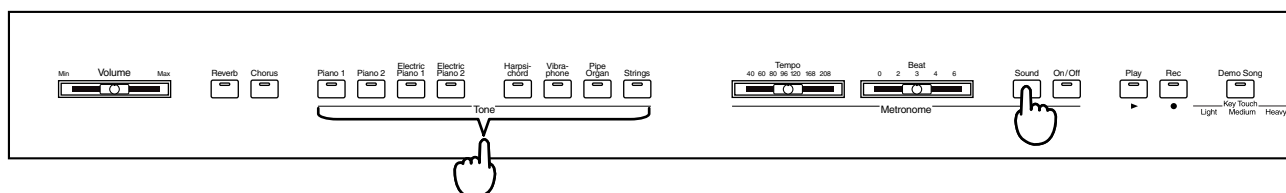

1. Hold down the Tone button for the sound that you want to include in the split, and press the Metronome [Sound] button.

The indicator on the Tone button you have pressed will flash.

Play the keyboard and hear that two different sounds are played in the upper and lower sections.

The sounds will be assigned to the keyboard as follows:

Tone button	Lower Tone / Upper Tone
Piano 1	Acoustic Bass / Piano 1
Piano 2	Acoustic Bass / Piano 2
Electric Piano 1	Acoustic Bass / Electric Piano 1
Electric Piano 2	Acoustic Bass / Electric Piano 2
Harpsichord	Strings / Harpsichord
Vibraphone	Acoustic Bass / Vibraphone
Pipe Organ	Pipe Organ / Harpsichord
Strings	Strings / Piano 1

* Chorus (p. 19) cannot be applied to the tones with Acoustic Bass.

* The pedal will have no effect on what is played in the lower section of the keyboard.

2. To cancel Split, press a Tone button with an indicator that is extinguished.

The selected tone is effective for the entire keyboard.

Changing the Split Point

When you are using the Split function, you can change the location at which the keyboard is split (the Split Point).

Hold down the Tone button whose indicator is blinking, and press the note that you wish to use as the new Split Point.

The Split Point can be set from B1–B6.

The key that serves as the split point is included in the lower section.

The Split Point you set will be retained until the piano is switched off.

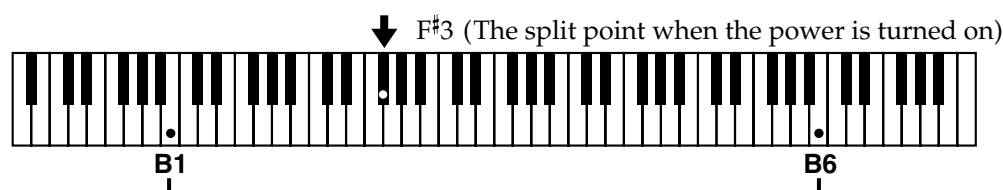

Adding Reverberation to the Sound—Reverb Effect

The MP-500 allows you to add reverberation to what you play on the keyboard. With the Reverb Effect, you can get a pleasant reverberation, making it sound as if you were performing in a concert hall or similar space.

The settings of the Reverb Effect cannot be memorized independently for each sound. When the power is turned on, the Reverb Effect will be cancelled.

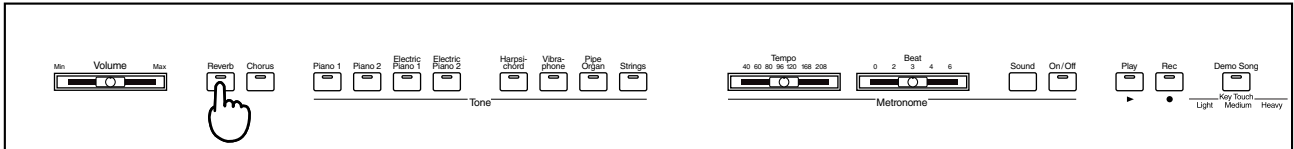

1. Press the [Reverb] button to turn on the indicator.

The Reverb Effect will be applied to the entire sound.

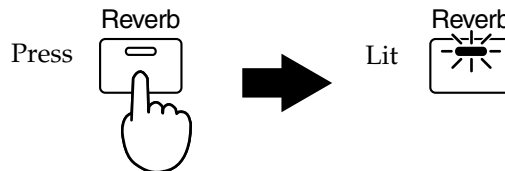

2. To cancel the Reverb Effect, press the [Reverb] button once again to make the indicator go dark.

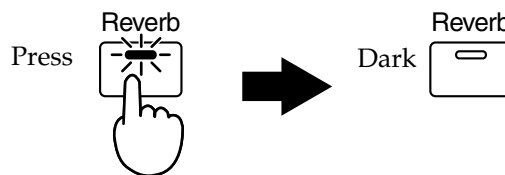

The amount of Reverb can be changed. Please refer to "Changing the Depth of the Reverb" (p. 27).

Adding Breadth to the Sound—Chorus Effect

The MP-500 allows you to add chorus to what you play on the keyboard. By adding the Chorus Effect, you can give the sound greater dimension, with more fatness and breadth.

The settings of the Chorus Effect are memorized independently for each sound. When the power is turned on, the Chorus Effect will be applied to the “Electric Piano 1,” “Electric Piano 2” and “Vibraphone” sounds. The Chorus Effect will be turned off for the other sounds.

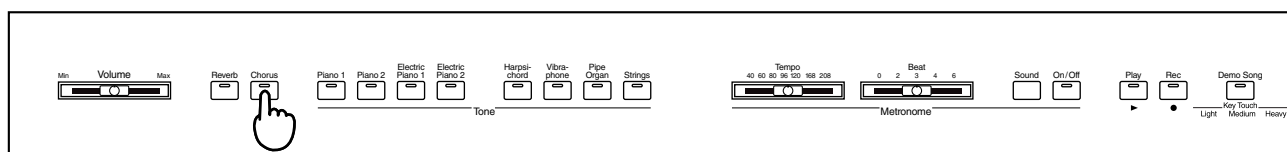

1. Press the [Chorus] button to turn on the indicator.

The Chorus Effect will be applied to the currently selected sound.

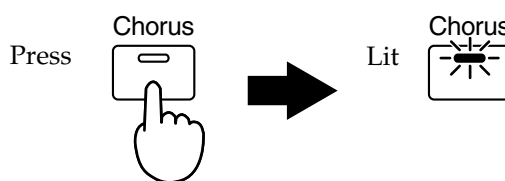

When you select a sound for which the Chorus Effect has not been turned on, the [Chorus] button indicator will go dark.

2. To cancel the Chorus Effect, press the [Chorus] button once again to make the indicator go dark.

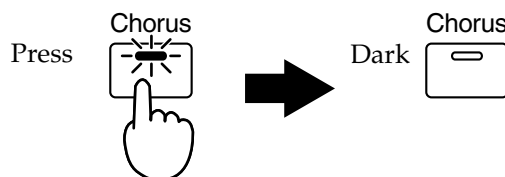

While using the Dual (p. 16) or Split (p. 17) functions, lighting/extinguishing the [Chorus] button's indicator will switch the Chorus Effect on/off for both sounds. (However, when Split is being used, the Chorus Effect will not be applied to the Acoustic Bass.)

After Dual or Split is cancelled, the piano reverts to the Chorus Effect setting that a particular sound normally carries.



The on/off status of the [Chorus] button is not remembered when Dual or Split are used.



The amount of Chorus can be changed. Please refer to “Changing the Depth of the Chorus” (p. 27).

Sounding the Metronome

You can start or stop the metronome with a single button.
 In addition to adjusting the tempo and time, you can also change the sound and volume of the metronome.

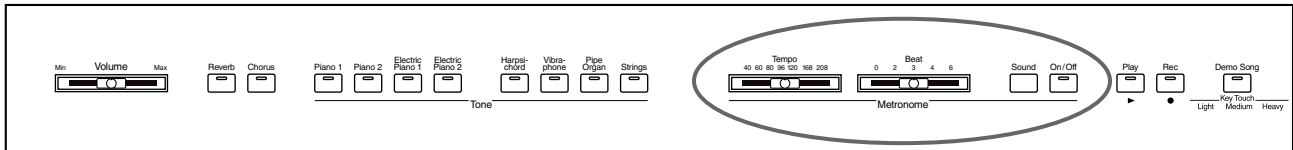

- 1. Press the Metronome [On/Off] button, and the metronome will begin sounding.**

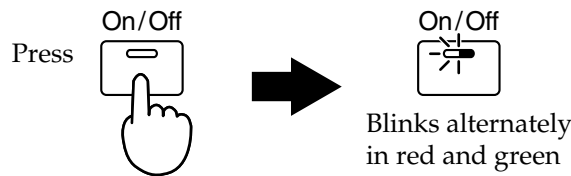

The Metronome [On/Off] button indicator will blink in red and green in time with the currently selected time. It will blink in red on the downbeats, and in green on the upbeats.

If the Metronome [Beat] slider is in the "0" position, the indicator will blink in green.

- 2. When you press the Metronome [On/Off] button once again to make the indicator go dark, the metronome will stop sounding.**

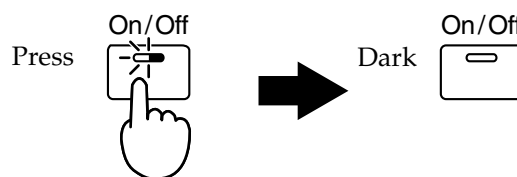

■ Adjusting the Metronome Volume

The metronome volume can be adjusted in 8 levels.

The metronome volume is set to "4" when the keyboard is turned on.

While holding down the Metronome [On/Off] button, also press any Tone button.

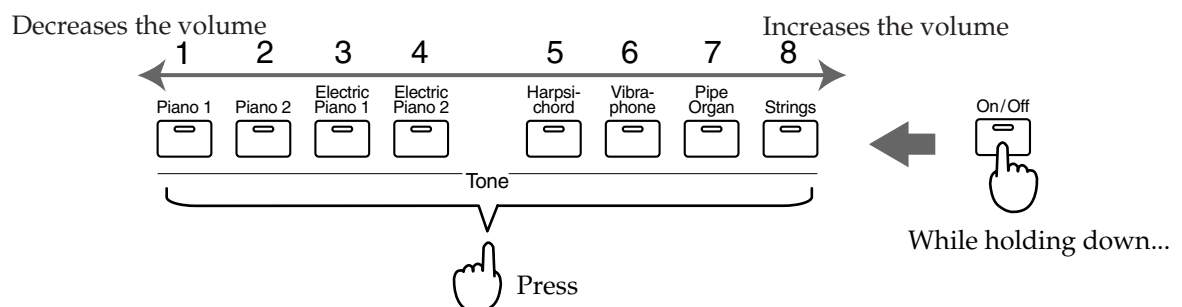

■ Checking the Metronome Volume

Press and hold the Metronome [On/Off] button.

The Tone button indicators will blink to indicate the current volume.

■ Changing the Metronome Tempo

The metronome tempo is adjusted by the Metronome [Tempo] slider.

You can select a tempo in the range of 40–208.

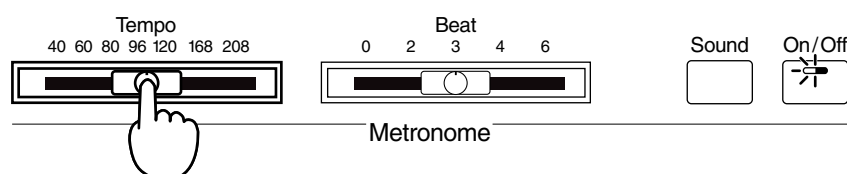

■ Changing the Time of the Metronome

Use the Metronome [Beat] slider to select the time of the metronome.

You can select from the following five types: 0 (only upbeat sounds), 2 (2-beat), 3 (3-beat), 4 (4-beat), 6 (6-beat).

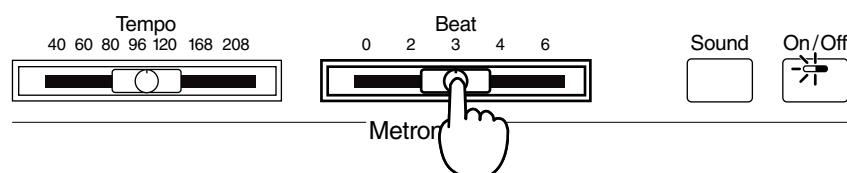

■ Changing the Metronome Sound

You can select from three types of metronome sound: “ordinary metronome sound,” “electronic metronome sound,” and “dog and cat sounds.”

“Ordinary metronome sound” is the power-on default for the metronome sound.

1. Press the Metronome [On/Off] button to sound the Metronome.
2. Press the Metronome [Sound] button.

Each time you press the Metronome [Sound] button, the metronome sound will change to the next choice available, either “ordinary metronome sound,” “electronic metronome sound,” or “dog and cat sounds.”

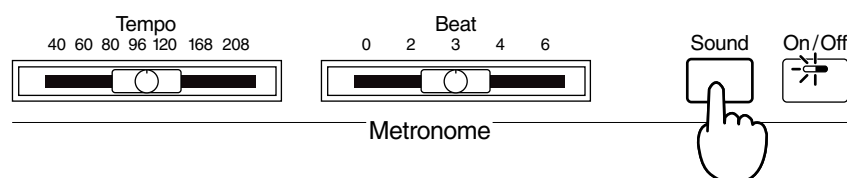

Try Recording Your Performance

You can record what you play on your piano.

NOTE Only one song can be recorded on the MP-500. If a previously recorded performance exists, it will be erased the moment you begin recording another performance.

NOTE The performance data that you recorded will disappear when the power of the MP-500 is turned off.

NOTE After approximately 5,000 notes have been recorded, the [Play] button's and [Rec] button's indicators will go out, and recording will end automatically.

Recording

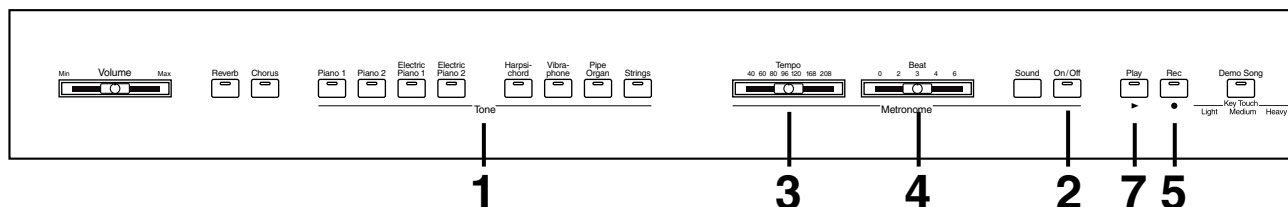

1. Use the Tone buttons to select the sound with which you wish to perform.

You can change the tones during the recording of the song.

2. Press the Metronome [On/Off] button to turn on the indicator.

The metronome will sound.

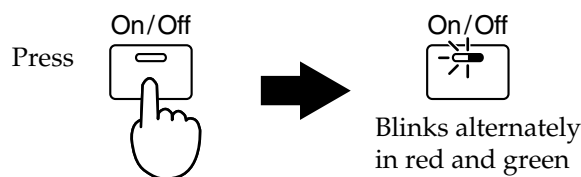

While listening to the metronome, select the tempo and time of the song that you wish to record.

3. Use the Metronome [Tempo] slider to select the basic tempo for the song.

Moving the Metronome [Tempo] slider after recording has begun will not change the tempo.

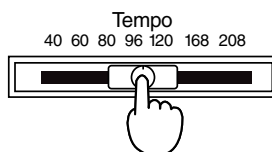

4. Use the Metronome [Beat] slider to select the time for the song.

The time of the song cannot be changed during or after recording.

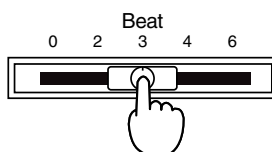

5. Press the [Rec] button to turn on the indicator.

The keyboard is put in record standby mode.

The [Play] button's indicator flashes.

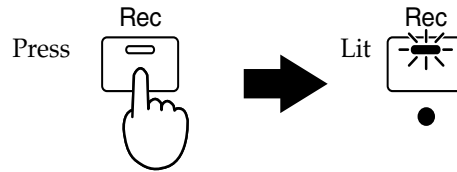

If you want to cancel the recording, then press the [Rec] button once more to make the indicator dark.

If you wish to stop the metronome, press the Metronome [On/Off] button to make the indicator go dark.

In the beginning it is probably a good idea to listen to the metronome as you record. The sound of the metronome is not recorded.

6. Recording will begin when you play a note on the keyboard.

The [Play] button indicator will change from blinking to lit.

Instead of playing the keyboard, you can also begin recording by pressing the [Play] button to make the indicator light. In this case, you will hear a two-measure count before recording begins.

Listen to the metronome, and play along with the tempo.

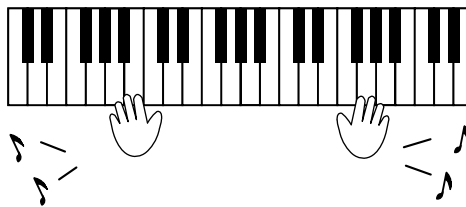

7. When you are finished recording, press the [Play] button to make the indicator go dark.

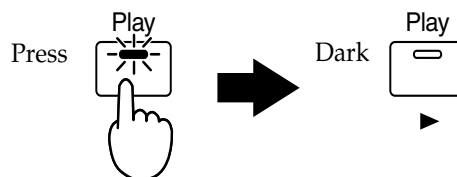

You can use a MIDI sequencer to save the recorded performance. Please refer to "Transmitting Performance Data from MIDI Out" (p. 35).

Listening to the Recorded Performance

Listen to the performance you recorded.

1. Press the [Play] button to make the indicator light.

The performance you recorded will play back. When the recorded performance ends, the [Play] button indicator will go dark, and playback will stop.

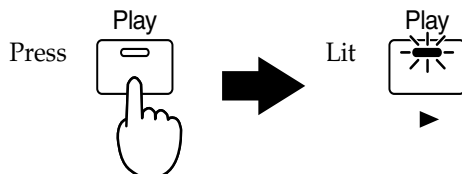

2. If you wish to stop playback during the performance, press the [Play] button to make the indicator go dark.

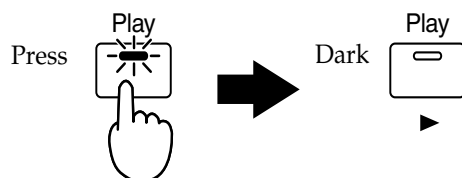

If the metronome is sounding while the performance plays back, the playback will begin after a two-measure count.



If you have recorded in Dual Play (p. 16), you can play back the Performance with a different volume balance between the two layered tones. Please refer to “Changing the Volume Balance in Dual Play” (p. 27).

Deleting Recorded Songs

You can delete recorded songs in their entirety.

While pressing the [Play] button, also press the [Rec] button.

This deletes the recorded song.

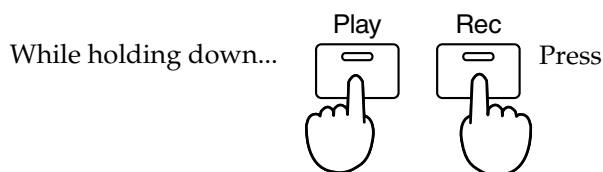

Convenient Functions

Changing Keyboard Touch Sensitivity

You can select from three touch sensitivity levels.

When the power is turned on, the response is set to "Medium."

While holding down the [Demo Song/Key Touch] button, press the corresponding note (A3–B3).

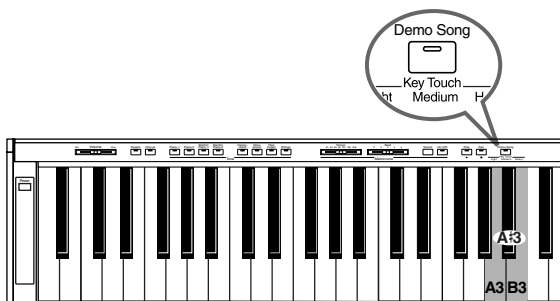

Keys	Types	Descriptions
A3	Light	With this setting, fortissimo can be produced using much less force than normal, thus making the keys seem lighter. This setting makes it easy to play, even for children.
A#3	Medium	Normal setting, providing the most natural touch, closest to that of an acoustic piano.
B3	Heavy	With this setting, to play fortissimo the keys must be played much more strongly than normally, as if the keys had become heavier. Adds even more emotion when you play with lots of dynamics.

Transposing without Changing Your Fingering —Key Transpose

You can play in a different key—without changing the keys you are playing. This function is called "Key Transpose." When you are accompanying a singer, you can use Key Transpose to match the vocal pitch of the singer, allowing you to transpose easily while using the same printed music (keyboard fingering).

Key transpositions remain in effect until the keyboard's power is turned off.

1. While holding down the [Demo Song/Key Touch] button, press the tonic (root) of the key to which you want to transpose.

Use the C2–B2 notes to select the tonic.

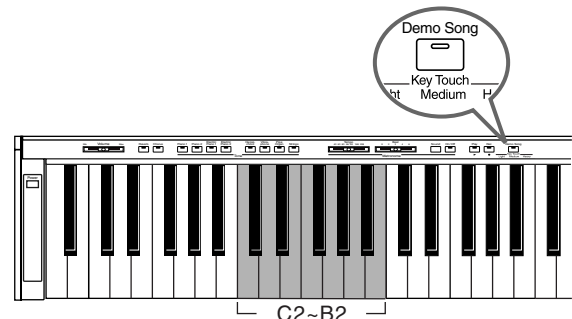

2. To return to the normal pitch, while holding down the [Demo Song/Key Touch] button, press the C2 key.

<Ex.>

For example if you want the E pitch to sound when you play the C key, you would hold down the [Demo Song/Key Touch] button and press the E2 key.

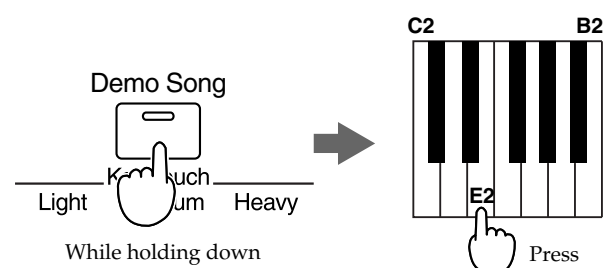

NOTE

The transposition setting is effective only on sounds performed on the MP-500's keyboard. This setting is not effective on tones from external MIDI messages played on the MP-500.

Adjusting the Pitch of the Sound—Master Tuning

In situations such as when playing in ensemble with other instruments, you can adjust the MP-500's reference pitch to that of another instrument.

Middle A is generally used as the standard reference pitch for tuning instruments.

When playing in ensemble with other instruments, set each instrument to the same reference pitch to ensure that you will be in tune with each other. This tuning of all the instruments to a reference pitch is called "Master Tuning."

The reference pitch can be set to any value from 415.3 Hz–466.2 Hz.

"440.0 Hz" is the power-on default for the reference pitch.

Use the C4–D#4 notes to adjust the pitch.

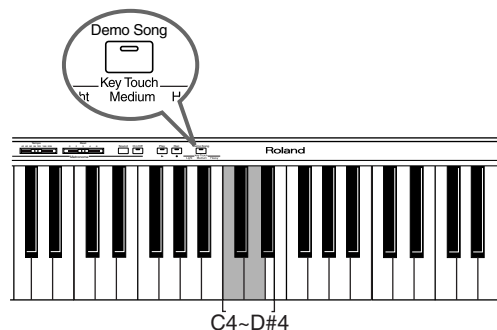

■ Lowering/ raising the Reference Pitch

While holding down the [Demo Song/Key Touch] button, press the "C4" note to lower the reference pitch, or the "D4" note to raise it.

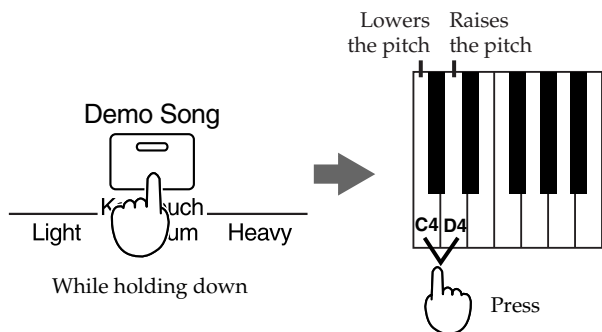

Each time you press the "C4" key, the pitch will fall by 0.1 Hz. If you continue holding the key, the pitch will continue falling.

Each time you press the "D4" key, the pitch will rise by 0.1 Hz. If you continue holding the key, the pitch will continue rising.

■ Setting the Reference Pitch to 440.0 Hz

While holding down the [Demo Song/Key Touch] button, press the "C#4" key on the keyboard.

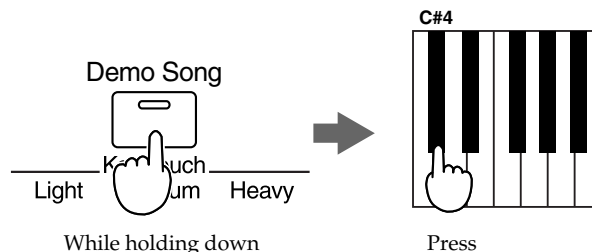

The reference pitch will be set to 440.0 Hz. This is the most commonly used setting. The A4 (Middle A) key will sound at 440.0 Hz.

■ Setting the Reference Pitch to 442.0 Hz

While holding down the [Demo Song/Key Touch] button, press the "D#4" key on the keyboard.

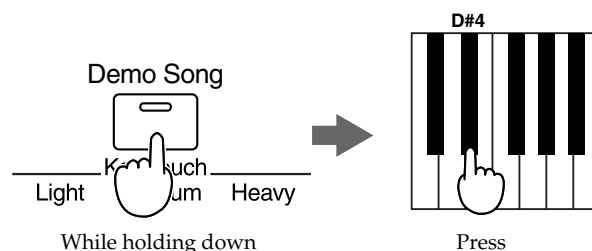

The standard pitch will be set to 442.0 Hz. This setting is often used for concert pianos. The A4 (Middle A) key will sound at 442.0 Hz.

Sounding a reference tone while you adjust the pitch

Holding down the [Demo Song/Key Touch] button, press the [Sound] button, and while continuing to hold down the two buttons, press the corresponding key. You can hear a reference tone (Middle A) as you adjust the pitch.

Changing the Volume Balance in Dual Play

You can change the volume balance between the two layered sounds in Dual Play (p. 16).

When the Keyboard is turned on, the response is set to "Standard."

This setting remains in effect until the keyboard's power is turned off.

While holding down the [Demo Song/Key Touch] button, press the corresponding note (C7–E7).

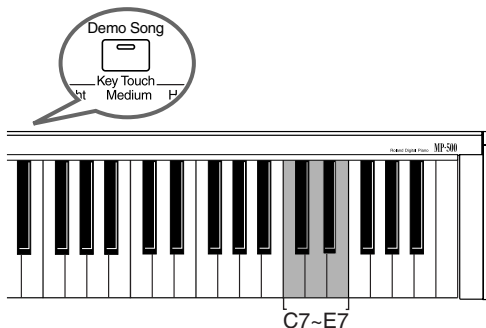

Key	Description
C7	Of the two selected tones, the sound assigned to the left Tone button sounds louder.
C#7	Of the two selected tones, the sound assigned to the left Tone button sounds somewhat louder.
D7	Standard
D#7	Of the two selected tones, the sound assigned to the left Tone button sounds somewhat quieter.
E7	Of the two selected tones, the sound assigned to the left Tone button sounds quieter.

MEMO

If you have recorded in Dual Play (p. 16), you can use the operation above to play back the Performance with a different volume balance between the two layered tones.

Changing the Depth of the Reverb

The depth of the Reverb Effect (p. 18) can be adjusted.

There are eight levels of depth from which to choose.

This is set to "4" when the power is turned on.

Holding down the [Reverb] button, press any Tone button.

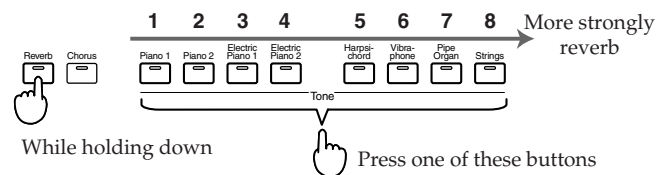

■ Checking the depth of the Reverb Effect

Press and hold the [Reverb] button.

The Tone button indicators will blink to indicate the selected depth.

Changing the Depth of the Chorus

The depth of the Chorus Effect (p. 19) can be adjusted.

There are eight levels of depth from which to choose.

This is set to "4" when the power is turned on.

Holding down the [Chorus] button, press any Tone button.

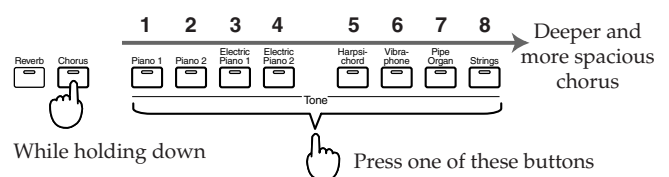

■ Checking the depth of the Chorus Effect

Press and hold the [Chorus] button.

The Tone button indicators will blink to indicate the selected depth.

Changing the Damper Pedal's Resonance

On acoustic pianos, when the damper pedal is depressed, additional strings are released to resonate with the sound of the keys that have been played, adding richness and breadth to the sound. The damper pedal on the MP-500 recreates this resonance when depressed. This resonance is called "Sympathetic Resonance."

Eight levels of resonance are available. This is set to "4" when the power is turned on.

Holding down the [Reverb] and [Chorus] buttons, press any Tone button.

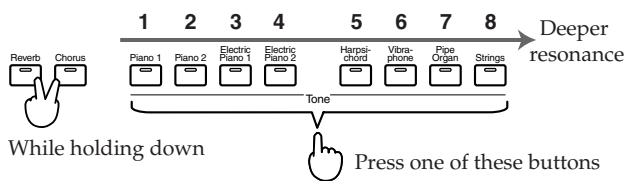

■ Checking the Resonance level

Press and hold the [Reverb] and [Chorus] buttons.

The Tone button indicators will blink to indicate the selected depth.

NOTE

This resonance works only with the piano tones.

Playing Songs Using Tunings from Classical Music

Your instrument also allows you to perform using the tunings that were in use at the time that classical music (such as Baroque) was composed. Most modern songs are composed based on assumption that equal-tempered tuning, the tuning in use almost universally today, will be used when performing. However, in the age of classical music there were a variety of different tunings in existence. Try performing using tunings from those olden times so you can hear what the chords in certain pieces sounded like originally.

"Equal temperament" is placed in effect each time the keyboard's power is turned on.

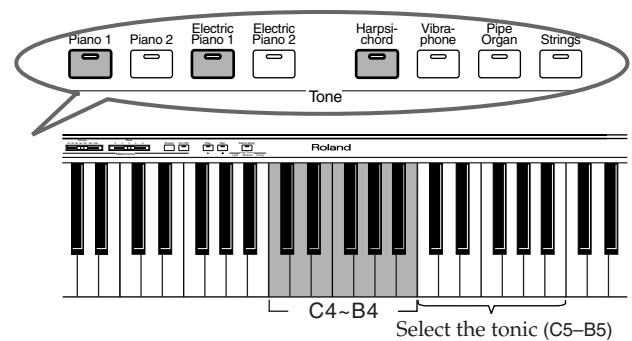

1. While holding down the [Piano 1], [Electric Piano 1], and [Harpsichord] buttons, press the corresponding key (C4–B4).

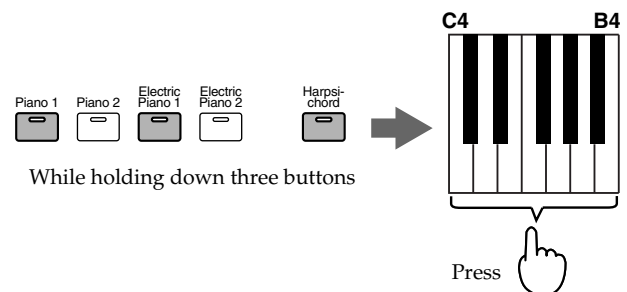

2. To select the keynote (tonic), hold down the [Piano 1], [Electric Piano 1], and [Harpsichord] buttons and press a key in the range of C5–B5 to specify the desired note.

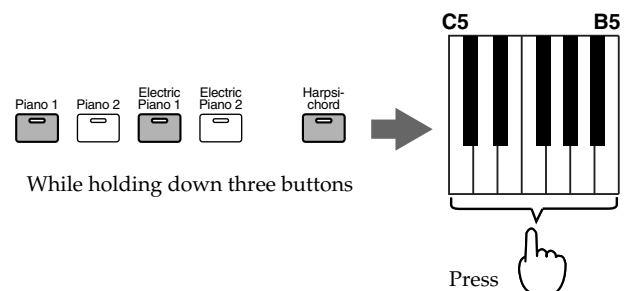

MEMO

When you want to perform using a tuning other than equal temperament, you'll need to specify the keynote (tonic for major, sixth for minor) appropriate for the key of the song you want to play.

Key Temperament Description

C4	Equal	With this tuning, the octave is divided into twelve equal intervals. Regardless of the interval, very little ambiguity is produced.
D4	Pythagorean	Developed by the philosopher Pythagoras as a method of tuning that resolved the ambiguousness of fourths and fifths. As a result, melodies sound cleaner, but a certain amount of ambiguousness is produced with triads.
E4	Just Major	This tuning eliminates the ambiguousness of fifths and thirds. This tuning is not suitable for melodies, and transposition is impractical, but rich sonorities can be produced by chords.
F4	Just Minor	Just Major and Minor tunings are different. You can get the same effects in the minor scale as in the major scale.
G4	Mean Tone	A partial compromise of the Just Major tuning, created to make transposition possible.
A4	Werckmeister	A combination of the Mean Tone and Pythagorean tunings. This tuning can be used in all keys.
B4	Kirnberger	As a result of improvements made to the Mean Tone and Just temperaments, it is relatively tolerant towards transposition, and can be used to play in all keys.

NOTE

When performing in ensemble with other instruments, be aware that depending on the key, there may be some shifting of the pitch. Please tune to the other instruments in the ensemble.

NOTE

When you play back a recorded performance, it will be played using the temperament that was selected at that time.

Changing Tuning Curves

Pianos are commonly tuned so pitches in the lower registers are adjusted relatively flat, and pitches in the higher registers are tuned sharper compared to equal temperament. This kind of tuning method for the piano is called "Stretch Tuning."

The graphic representation of the differences in pitch when comparing equal-tempered tuning with the actual tuning used is called the "Tuning Curve." Changing the tuning curve results in a subtle change in the sound of the chords. MP-500 can switch the tuning curve.

"Type 2" (Stretch Tuning) is the power-on default for the tuning curve.

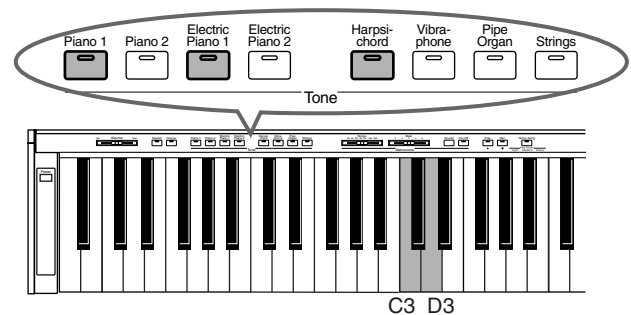

While holding down the [Piano 1] button, [Electric Piano 1] button, and [Harpsichord] button, the "C3" note to turn the setting Type 1, or press the "D3" note to turn the setting Type 2.

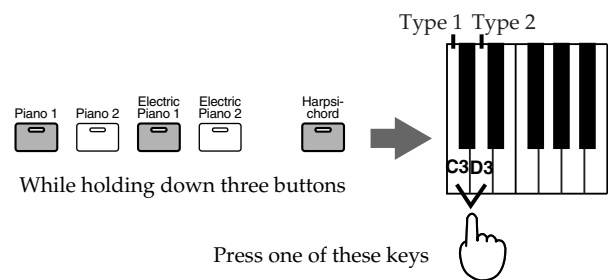

Key	Type	Description
C3	Type 1	Standard tuning curve. This is the right choice when using Dual Play (p. 16), or when playing in ensemble with other instruments.
D3	Type 2	A tuning curve wherein the low and high registers are widened slightly—low pitches are a little lower, the high pitches a little higher (Stretch Tuning). Appropriate for piano solos.

NOTE

This setting is only available with piano tones.

Disabling Buttons—Panel Lock

By using the Panel Lock function, you can disable the buttons with the exception of certain operations. This is a convenient way to prevent buttons from being pressed inadvertently, changing the settings.

When the panel is locked, the following operations can be performed.

- Play using the piano sound
- Changing keyboard touch sensitivity (p. 25)
- Key Transpose (p. 25)
- Master Tuning (p. 26)

1. Before switching the power on, turn the volume all the way down.

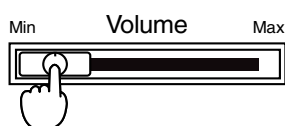

2. Press the [Power] switch to turn off the power.

3. While holding down the [Piano 1] button, press the [Power] switch to turn on the power.

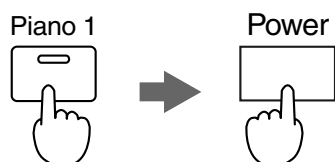

While holding down

Press the [Power] switch

4. Adjust the volume.

Playing the keyboard now produces a Piano 1 sound. It will not be possible to switch to another sound.

Switching the power off and back on again releases the panel lock and returns the MP-500 to its usual state.

MEMO

You can set Panel Lock in Step 3 above by turning on the power while holding down any Tone button other than the [Piano 1] button. In that case, you can play using only the tone of the button that was pressed.

Panel Lock with the metronome enabled

If you turn on the power while holding down the Metronome [On/Off] button, it will also be possible to sound the metronome. You will also be able to adjust the metronome tempo, time, volume, and sound.

Connecting to MIDI Devices

Read this chapter if you wish to connect the MP-500 to an external MIDI device.

If the MP-500 is connected to a MIDI sequencer, such as one from the MT series, a performance recorded on the MP-500 can be transmitted to the MIDI sequencer. It is also possible to record the performance directly on the MIDI sequencer. The recorded performance can be saved on the MIDI sequencer.

When the MP-500 is connected to an MT series sequencer, the rich variety of sounds built into the MT series sequencer can be played from the keyboard of the MP-500.

About MIDI

MIDI, short for "Musical Instrument Digital Interface," was developed as a standard for the exchange of performance data between electronic instruments and computers.

The MP-500 is equipped with MIDI connectors to allow such exchange of performance data with external equipment and devices. Connecting the keyboard to other devices with these jacks provides you with an even greater variety of ways to use your keyboard.

About the MIDI Connectors

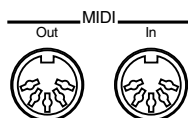

MIDI connectors on the rear panel

MIDI In Connector

Use a MIDI cable (sold separately) to connect from here to the MIDI Out connector on the external MIDI device. MIDI messages sent from connected external equipment will be received here. As a result, the MP-500 will produce sound, change tones, or perform other operations.

MIDI Out Connector

Use a MIDI cable (sold separately) to connect from here to the MIDI In connector on the external MIDI device. Performance data detailing what has been played on the keyboard, and other data, such as that generated when a pedal is depressed, is sent out from here to external MIDI devices.

Making the Connections

NOTE

To prevent malfunction and/or damage to speakers or other devices, always turn down the volume, and turn off the power on all devices before making any connections.

1. Turn the volume down completely on all equipment.
2. Turn off the MP-500 and any other devices to be connected.
3. Use the optional MIDI cable to connect the MIDI connector on the external MIDI device to the MIDI connector on the MP-500.
Take a look at the connection examples.
4. Turn on the power to all equipment.
5. Adjust the volume.
6. You should also make the following settings as needed.

For details on making MIDI-related settings for the MP-500, refer to p. 32 through p. 35.

Connection Examples: Connecting to a sequencer (The Roland MT Series)

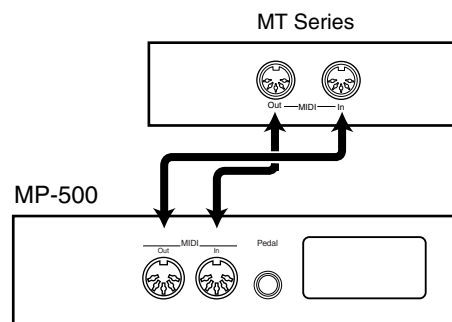

* The MT-90s has no MIDI Out connector.

Connection Examples: Connecting to a MIDI sound module

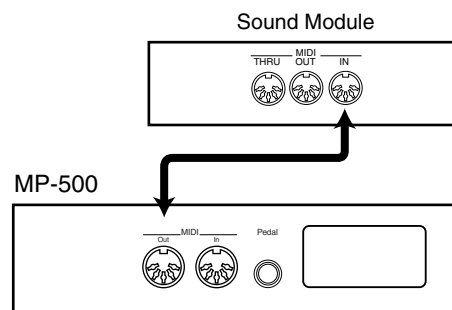

Cautions when Connecting an External MIDI Device

Here we will explain the “Local On/Off” and “Omni On/Off” settings that you need to be aware of when connecting the MP-500 to an external MIDI device.

■ Disconnecting the MP-500’s keyboard and internal sound generator—Local On/Off

When the MP-500 is connected to a MIDI sequencer or the like, set it to Local Off.

As shown in the diagram, the data that is produced when you play the keyboard will reach the sound generator by two routes, (1) and (2), causing each note to be played in duplicate. To prevent this, select the Local Off setting to cut route (1).

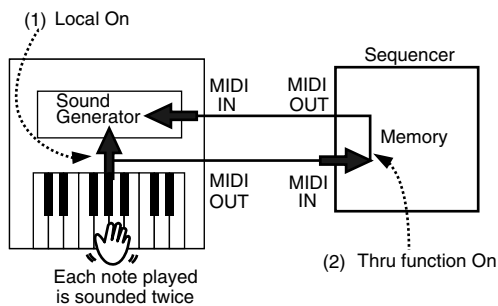

This sets it to Local On:

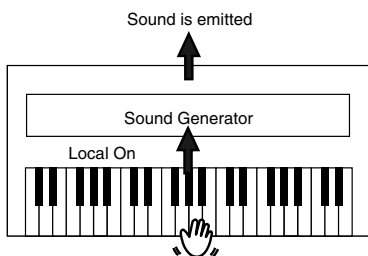

This sets it to Local Off:

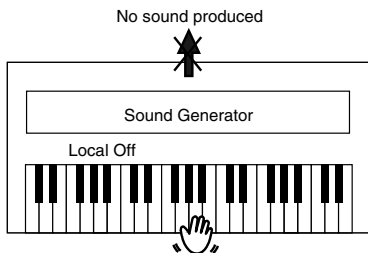

NOTE

Be aware that if you set your instrument to Local Off when no external MIDI device is connected, there will be no sound.

■ Switching Local On/Off

Local On is set when the power is switched on.

While holding down the [Piano 1] button, [Piano 2] button, and [Harpischord] button, the “B4” note to turn the setting On, or press the “C5” note to turn the setting Off.

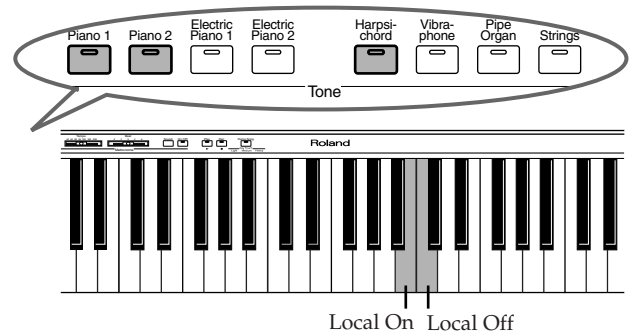

MEMO

If the MP-500 is connected to a Roland MT series (except MT-90s), it is not necessary to make the Local Off setting. When the power is turned on, the MT series will transmit a Local Off message. If you turn the power on in the order of first the MP-500 and then the MT series, the MP-500 will automatically be set to Local Off.

■ Receiving on all MIDI channels—Omni On/Off

When set to Omni On, the MP-500 will sound as a result of received MIDI messages, no matter which channel the messages arrive on.

When set to Omni Off, the MP-500 will recognize only the messages that arrive on the MIDI channel that has been selected, as explained under “Set the MIDI Channel.”

■ Switching Omni On/Off

Omni On is automatically set when the power is switched on.

Hold down the [Piano 1] button, the [Piano 2] button, and the [Harpsichord] button, and press the “F4” note to turn the setting On, or the “G4” note to turn the setting Off.

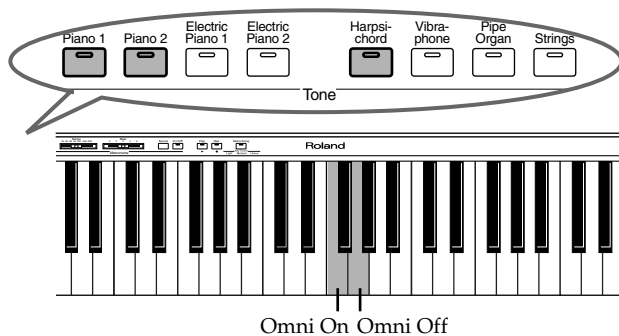

Set the MIDI Channel

MIDI features sixteen MIDI channels, numbered 1–16.

The connected devices must be set to use the same MIDI channels, otherwise no sound will be produced.

- In a setup where you wish to play the MP-500 and also have another MIDI-equipped instrument or sound module play the same notes, you should first set the channel used for reception on your external device to the same channel that you have the MP-500 set to use for transmission.
- If using another MIDI keyboard as a master instrument, and you wish to have the MP-500 played by it, you would need to set the channel used for reception on the MP-500 to the same channel that the master keyboard will be transmitting on.
- When wishing to have a sequencer play the MP-500, you need to set the channel used or reception on the MP-500 to the same channel that the recorded MIDI data is set to use.

When the MP-500 is turned on, Channel “1” is selected.

While holding down the [Piano 1], [Piano 2], and [Harpsichord] buttons, press the appropriate key (C2–D4) on the keyboard.

The MIDI transmit channel and receive channel will switch to the number that corresponds to the note you pressed.

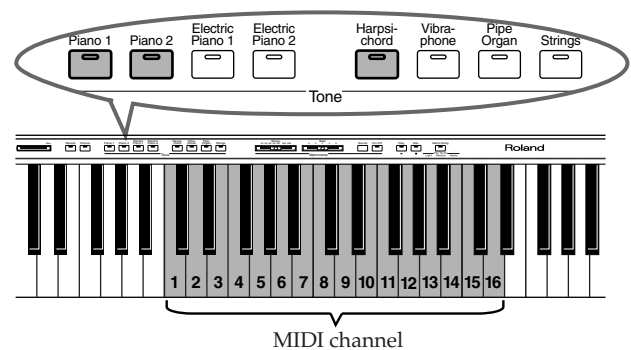

Transmitting/Receiving Sound Selection Data—Program Change

Program Changes are messages that tell an instrument to “switch to sound number x.”

When the other device receives this message, it will switch to whichever of its sounds corresponds to the number contained in the message.

When you press the MP-500’s Tone button to change tones, a Program Change message with the corresponding Program Number is sent via the MIDI Out connector. Furthermore, a Program Change message received via the MIDI In connector changes the tone to the one with the corresponding Program Number.

Each time the power is turned on, the instrument will always be set to “On” (it will transmit/receive Program Change messages).

If you set it to “Off,” the MP-500 will no longer send out Program Change message when you change the tone being used. Also, the MP-500 will then ignore any Program Change messages when that are sent to it by an external unit, and will not change the tone it is playing.

While holding down the [Piano 1] button, [Piano 2] button, and [Harpsichord] button, press the “E5” note to turn the setting On, or the “F5” note to turn the setting Off.

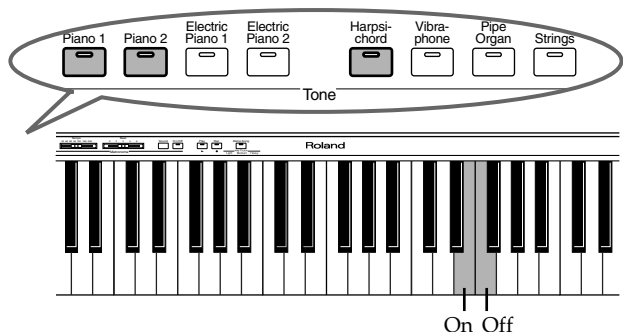

The tones and their corresponding Program Number appear below:

Program Number	Tone
01	Piano 1
02	Piano 2
03	—
04	Harpsichord
05	Vibraphone
06	Electric Piano 1
07	Electric Piano 2
08	Pipe Organ
09	Strings
10	Piano1 + Piano2
11	Piano1 + Harpsichord
12	Piano1 + Vibraphone
13	Piano1 + Electric Piano1
14	Piano1 + Electric Piano2
15	Piano1 + Pipe Organ
16	Piano1 + Strings
17	Piano2 + Harpsichord
18	Piano2 + Vibraphone
19	Piano2 + Electric Piano1
20	Piano2 + Electric Piano2
21	Piano2 + Pipe Organ
22	Piano2 + Strings
23	Harpsichord + Vibraphone
24	Harpsichord + Electric Piano1
25	Harpsichord + Electric Piano2
26	Harpsichord + Pipe Organ
27	Harpsichord + Strings
28	Vibraphone + Electric Piano1
29	Vibraphone + Electric Piano2
30	Vibraphone + Pipe Organ
31	Vibraphone + Strings
32	Electric Piano1 + Electric Piano2
33	Electric Piano1 + Pipe Organ
34	Electric Piano1 + Strings
35	Electric Piano2 + Pipe Organ
36	Electric Piano2 + Strings
37	Pipe Organ + Strings
38	Acoustic Bass / Piano1
39	Acoustic Bass / Piano2
40	Strings / Harpsichord
41	Acoustic Bass / Vibraphone
42	Acoustic Bass / Electric Piano1
43	Acoustic Bass / Electric Piano2
44	Pipe Organ / Harpsichord
45	Strings / Piano1

Turning Transmission and Reception of Control Changes On/Off

Messages known as “Control Changes” are used to convey to another device information about the instances where you have pressed a pedal, or have turned On/Off the Chorus or Reverb effects.

Each time the power is turned on, the instrument will always be set to “On” (it will transmit/receive all Control Change messages).

If you set it to “Off” the MP-500 will no longer send or receive any Control Change messages.

While holding down the [Piano 1] button, [Piano 2] button, and [Harpischord] button, press the “A5” note to turn the setting On, or the “B5” note to turn the setting Off.

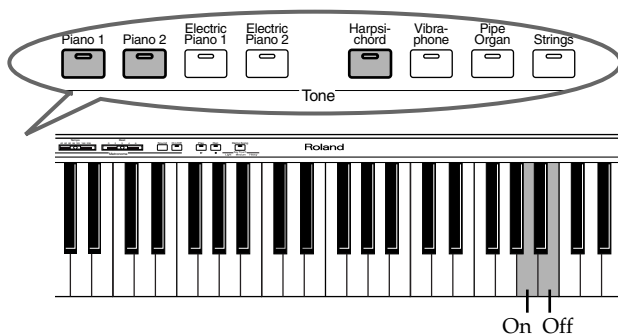

MEMO

If you want to know more about Control Change Number, please refer to “MIDI Implementation Chart” (p. 39).

Transmitting Performance Data from MIDI Out

If this setting is left “On,” performance data recorded on the MP-500 can be transmitted from the MIDI Out connector.

Each time the power is turned on, this setting will always be at “Off.”

Hold down the [Piano 1] button, the [Piano 2] button, and the [Harpischord] button, and press the “D6” note to turn the setting On, or the “E6” note to turn the setting Off.

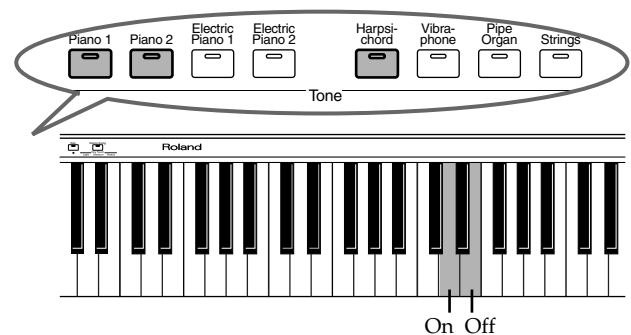

The performance data that you recorded will disappear when the power of the MP-500 is turned off.

If you wish to save the performance, use the following procedure.

1. Connect a MIDI sequencer such as the MT series (p. 31).
2. Record the performance on the MP-500 (p. 22).
3. Set this setting to “On.”
4. Start recording with the connected MIDI device.
5. Start playback of the recorded song on the MP-500.
6. When playback ends, stop recording with the connected MIDI device.
7. Use a connected MIDI sequencer to save the data on a floppy disk or other media.

Connecting to Audio Equipment

When you connect the MP-500 to audio equipment, you can play the sounds from the MP-500 through the speakers on the audio equipment or record your performances on a tape recorder or other recording device.

■ Connectors

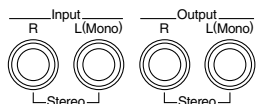

Output Jacks

You can connect audio equipment using audio cables (sold separately) and play the sounds from the MP-500 through the speakers on the connected equipment or record your performances on a tape recorder or other recording device. If the output of the connected device is monaural, you must use the L (Mono) jack.

Input Jacks

You can connect another sound source, such as audio equipment or an electronic instrument using audio cables (sold separately) and play the sounds from the connected device through the speakers on the MP-500. If the output of the connected device is monaural, you must use the L (Mono) jack.

■ Making the Connections

- * To prevent malfunction and/or damage to speakers or other devices, always turn down the volume, and turn off the power on all devices before making any connections.
- * Always make sure to have the volume level turned down before switching on power. Even with the volume all the way down, you may still hear some sound when the power is switched on, but this is normal, and does not indicate a malfunction.

○ Playing Sounds from the MP-500 Through the Speakers on Audio Equipment or Recording Your Performances on a Recording Device

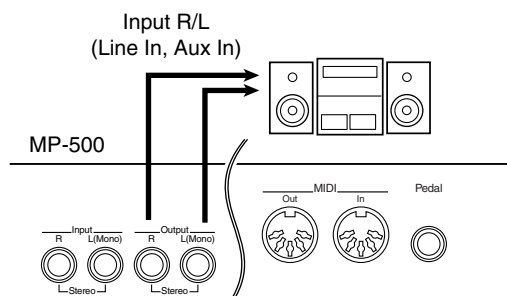

1. Turn the volume all the way down on the MP-500 and on the device you're about to connect.
2. Turn off the power to the MP-500 and other connected equipment.

3. Use audio cables (sold separately) to make the connection.
4. Turn on the power of the MP-500.
5. Switch on the connected device.
6. Adjust the volume level on the MP-500 and the connected device.

When Recording MP-500 Performances on a Recording Device

7. Start recording with the connected device.
8. Play the keyboard.
9. When the performance ends, stop recording on the connected equipment.

○ Playing Audio Equipment Sounds Through the Speakers on the MP-500

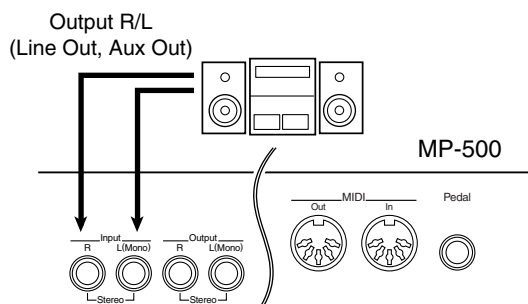

1. Turn the volume all the way down on the MP-500 and on the device you're about to connect.
2. Turn off the power to the MP-500 and other connected equipment.
3. Use audio cables (sold separately) to make the connection.
4. Turn on the power to the connected equipment.
5. Turn on the MP-500.
6. Adjust the volume level on the MP-500 and the connected device.

○ Turning the Power Off After Use

After use, follow the steps below to switch off the power.

1. Turn the volume all the way down on the MP-500 and on the device you're about to connect.
2. Turn off the power to the MP-500.
3. Turn off the connected equipment.

Troubleshooting

If you are encountering problems with the unit, please read the section below before assuming that there is a malfunction.

The piano cannot be switched on

- Is the power cord properly connected? (p. 10)

No sound is produced

- Is the [Volume] knob set to the minimum position? (p. 11)
- Are headphones connected? (p. 12)
- Is Local On/Off set to "Off"? (p. 32)

Demo songs do not play

- Is Panel Lock on? (p. 30)

Metronome does not sound

- Is Panel Lock on? (p. 30)

Buttons do not function

- Is Panel Lock on? (p. 30)

Keyboard sound does not change

- Is Panel Lock on? (p. 30)

Two sounds are produced when the keyboard is played

- Is the keyboard in Dual Play mode? (p. 16)

The pitch of the keyboard sounds incorrect

- Is the Master Tuning setting correct? (p. 26)
- Is the Key Transpose setting correct? (p. 25)
- Is the temperament or the Tuning Curve setting correct? (p. 28, p. 29)

The pedals are not functioning, or function intermittently

- Are the pedals connected properly?
Make sure the pedal cord is securely connected to the pedal jack on the back of the unit.

Can't Record

- Is Panel Lock on? (p. 30)
- Is the [Demo Song/Key Touch] button's indicator lit?
Press the [Demo Song/Key Touch] button; the button's indicator goes out (p. 13).
- The metronome sound or count sound is not recorded.

The recorded performance has been deleted

- The performance data that you recorded will disappear when the power of the MP-500 is turned off (p. 22).
- If you record again after recording, the first-recorded performance will be erased (p. 22).

Sound is distorted

- Is the [Volume] knob set to the maximum position? (p. 11)

Bass notes sound wrong/buzzing or vibration occurs

- If you can't hear the problem in the headphones:
When playing at high volumes, resonance may occur in the piano itself or in objects near the piano. At times, other objects in the room, such as fluorescent lights or glass doors, could start vibrating. Such phenomenon becomes more prevalent when sounding the lower frequencies at high volume. To minimize such unwanted resonance, please observe the following:
 - Locate the instrument so it is 10–15 cm away from walls.
 - Reduce the volume.
 - Increase the distance from the object that is resonating.
- If you can hear the problem in the headphones:
The problem may be for a different reason. Please contact your dealer.

In the upper range, the sound changes abruptly beyond a certain key

- On an acoustic piano, notes in the upper one and a half octaves of the keyboard continue to sound until they decay naturally, regardless of the damper pedal. There is a difference in the timbre as well. Roland pianos faithfully simulate such characteristics of the acoustic piano. On the MP-500, the range that is unaffected by the damper pedal will change depending on the Key Transpose setting.

<When the MP-500 is connected to an external device>

No sound is produced

- Is the power to all equipment turned on?
- Are the connections between MP-500 and the MIDI sequencer or the other external devices correct? (p. 31)
- Is the MIDI channel setting correct? (p. 33)
- Is the Omni On/Off setting correct? (p. 33)

Strange sounds (or two sounds) are produced when the MP-500 is played

- With the sequencer's "Thru" function on, the same notes may be sounded twice. Set the MP-500 to Local off (p. 32).

The volume level of the instrument connected to the Input jack is too low.

- Could you be using a connection cable that contains a resistor?
Use a connection cable that does not contain a resistor.

Functions Assigned to the Keyboard

Convenient Functions

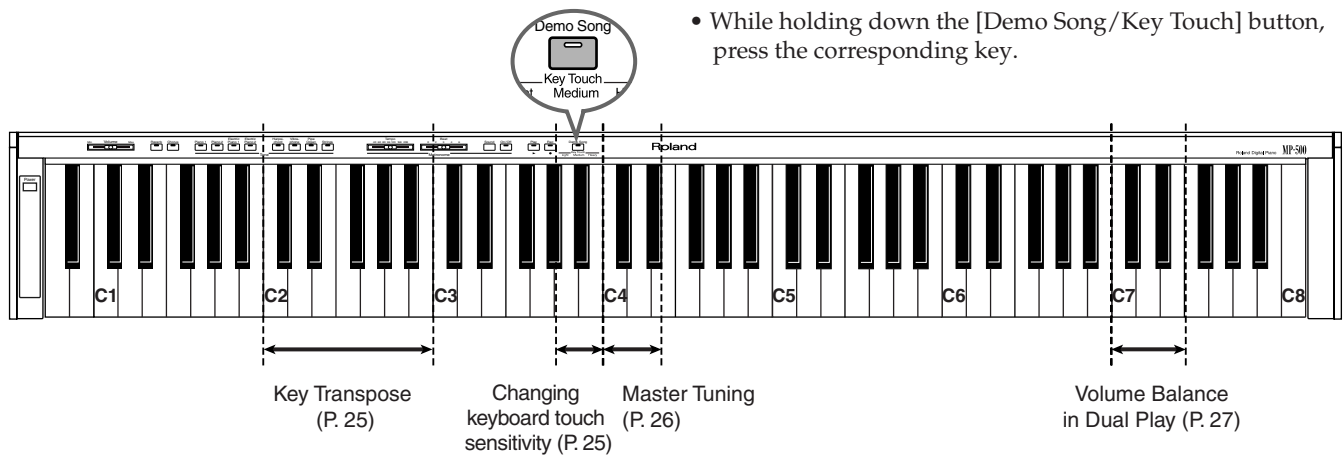

Functions for Temperament

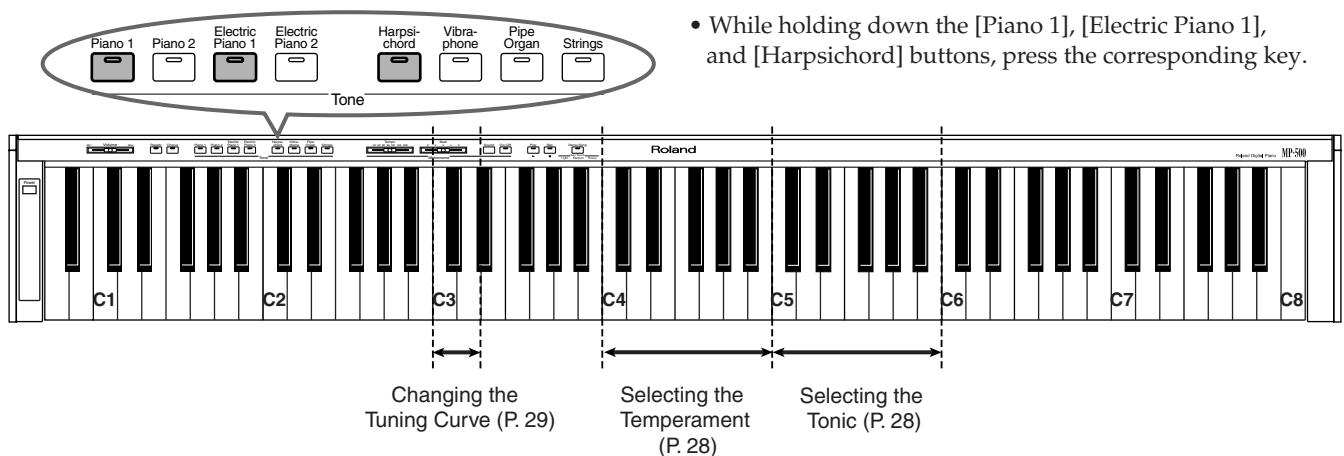

Functions for MIDI

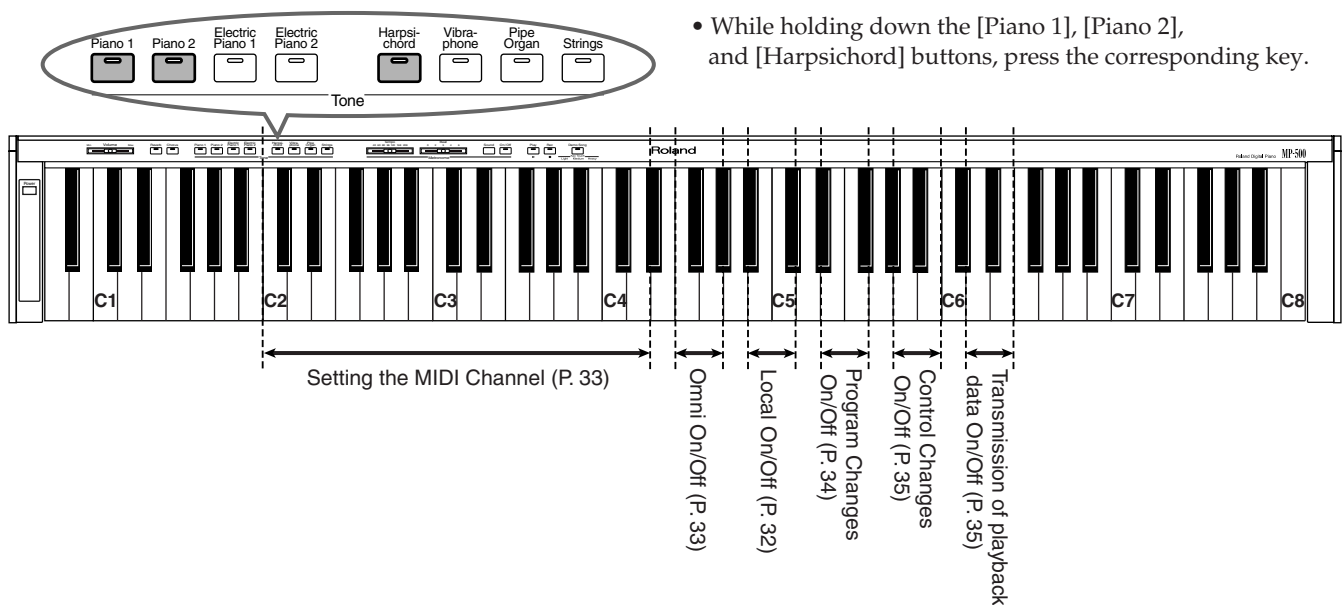

MIDI Implementation Chart

Function...	Transmitted	Recognized	Remarks
Basic Channel Default Changed	1 1-16	1 1-16	
Mode Default Messages Altered	Mode 1 x *****	Mode 1 OMNI ON/OFF	
Note Number : True Voice	15-113 *****	0-127 15-113	
Velocity Note ON Note OFF	O x 8n v=64	O x	
After Touch Key's Ch's	x x	x x	
Pitch Bend	x	x	
Control Change 6, 38 7 11 64 66 67 91 93 100, 101	O *1 x x O *1 O O *1 O *1 O *1 O *1 O *1	O *1 O *1 *2 O *1 *2 O *1 *2 O *1 *2 O *1 *2 O *1 O *1 O *1 O *1	Data entry Volume Expression Hold 1 Sostenuto Soft Effect1 depth (Reverb) Effect3 depth (Chorus) RPN LSB, MSB
Prog Change : True Number	O (0-44) *1 *****	O (0-127) *1 0-44	
System Exclusive	O	O	
System Common : Song Pos : Song Sel : Tune	x x x	x x x	
System Real Time : Clock : Commands	x x	x x	
Aux Message : All sound off : Reset all controllers : Local ON/OFF : All Notes OFF : Active Sense : System Reset	x x x x O x	x O O O (123-127) O x	
Notes	*1 O x is selectable. *2 This message can affect only MIDI notes.		

Mode 1 : OMNI ON, POLY Mode 2 : OMNI ON, MONO O : Yes
Mode 3 : OMNI OFF, POLY Mode 4 : OMNI OFF, MONO X : No

* A separate publication titled "MIDI Implementation" is also available. It provides complete details concerning the way MIDI has been implemented on this unit. If you should require this publication (such as when you intend to carry out byte-level programming), please contact the nearest Roland Service Center or authorized Roland distributor.

Specifications

MP-500: Roland Digital Piano

< Keyboard >

- **Keyboard**
88 keys (Progressive Hammer Action Mechanism)
- **Touch Sensitivity**
3 levels
- **Keyboard Mode**
Whole
Dual
Split

< Sound Generator >

- **Maximum Polyphony**
64 voices
- **Tones**
9 (Piano 1, Piano 2, Electric Piano 1, Electric Piano 2, Harpsichord, Vibraphone, Pipe Organ, Strings, Acoustic Bass (in Split mode))
- **Effects**
Chorus (8 levels)
Reverb (8 levels)
Sympathetic Resonance (8 levels)
- **Key Transposition**
-6 to +5 (semitone steps)
- **Temperament**
7 types, selectable tonic
- **Stretched Tuning**
2 types
- **Master Tuning**
415.3 Hz to 466.2 Hz (0.1 Hz steps)

<Composer>

- **Metronome**
Beat: 0, 2, 3, 4, 6
Volume: 8 levels
Sounds: 3 types
- **Track**
1 track
- **Song**
1 song
- **Note Storage**
Approx. 5,000 notes
- **Tempo**
Quarter note = 40 to 208
- **Resolution**
96 ticks per quarter note
- **Control**
Play/Stop, Rec, Tempo

<Others>

- **Pedals**
Damper, Sostenuto, Soft
- **Speakers**
12 cm x 2
- **Rated Power Output**
15 W x 2
- **Connectors**
Headphones Jack (Stereo) x 2
Input Jacks (R, L/Mono)
Output Jacks (R, L/Mono)
MIDI Connectors (In, Out)
Pedal Connector
- **Power Supply**
AC 117 V, AC 230 V, AC 240 V
- **Power Consumption**
32 W
- **Dimensions**
(including the piano stand)
1,398 (W) x 422 (D) x 820 (H) mm
55-1/16 (W) x 16-5/8 (D) x 32-5/16 (H) inches
(including the music stand)
1,398 (W) x 422 (D) x 1010 (H) mm
55-1/16 (W) x 16-5/8 (D) x 39-13/16 (H) inches
- **Weight (including the stand)**
48 kg / 106 lbs
- **Accessories**
Owner's Manual
Power Cord
Music Stand

* In the interest of product improvement, the specifications and/or appearance of this unit are subject to change without prior notice.

Index

A		
Audio Equipment.....	36	
B		
Beat.....	21	
C		
Chorus.....	19, 27	
Control Change.....	35	
D		
Delete.....	24	
Damper Pedal.....	10, 28	
Demo Song.....	13–15	
Dual Play.....	16, 27	
H		
Headphones.....	12	
I		
Input Jack.....	36	
K		
Key Transpose.....	25	
L		
Local On/Off.....	32	
M		
Master Tuning.....	26	
Metronome.....	20	
Sound.....	21	
Tempo.....	21	
Time.....	21	
Volume.....	20	
MIDI Channel.....	33	
MIDI Connector.....	31	
Music Stand.....	11	
O		
Omni On/Off.....	33	
Output Jack.....	36	
P		
Panel Lock.....	30	
Pedal.....	10	
Playing		
Demo Song.....	13	
Performance Song.....	24	
Program Change.....	34	
R		
Recording.....	22	
Reference Pitch.....	26	
Reverb.....	18, 27	
S		
Split.....	17	
Split Point.....	17	
Soft Pedal.....	10	
Song Delete.....	24	
Sostenuto Pedal.....	10	
Stretch Tuning.....	29	
Sympathetic Resonance.....	10, 28	
T		
Temperament.....	28	
Tempo.....	20	
Time.....	21	
Tone.....	16	
Tuning Curve.....	29	
V		
Volume		
Keyboard.....	11	
Metronome.....	20	



This product complies with the requirements of European Directives EMC 89/336/EEC and LVD 73/23/EEC.

For EU Countries

FEDERAL COMMUNICATIONS COMMISSION RADIO FREQUENCY INTERFERENCE STATEMENT

This equipment has been tested and found to comply with the limits for a Class B digital device, pursuant to Part 15 of the FCC Rules. These limits are designed to provide reasonable protection against harmful interference in a residential installation. This equipment generates, uses, and can radiate radio frequency energy and, if not installed and used in accordance with the instructions, may cause harmful interference to radio communications. However, there is no guarantee that interference will not occur in a particular installation. If this equipment does cause harmful interference to radio or television reception, which can be determined by turning the equipment off and on, the user is encouraged to try to correct the interference by one or more of the following measures:

- Reorient or relocate the receiving antenna.
- Increase the separation between the equipment and receiver.
- Connect the equipment into an outlet on a circuit different from that to which the receiver is connected.
- Consult the dealer or an experienced radio/TV technician for help.

This device complies with Part 15 of the FCC Rules. Operation is subject to the following two conditions:

- (1) This device may not cause harmful interference, and
- (2) This device must accept any interference received, including interference that may cause undesired operation.

Unauthorized changes or modification to this system can void the users authority to operate this equipment.
This equipment requires shielded interface cables in order to meet FCC class B Limit.

For the USA

NOTICE

This Class B digital apparatus meets all requirements of the Canadian Interference-Causing Equipment Regulations.

AVIS

Cet appareil numérique de la classe B respecte toutes les exigences du Règlement sur le matériel brouilleur du Canada.

For Canada

Contents		
No.	Name	Qty.
1	Instrument	1
2	Music Stand	1
3	Manual Set	1
4	AC Cord Set	1

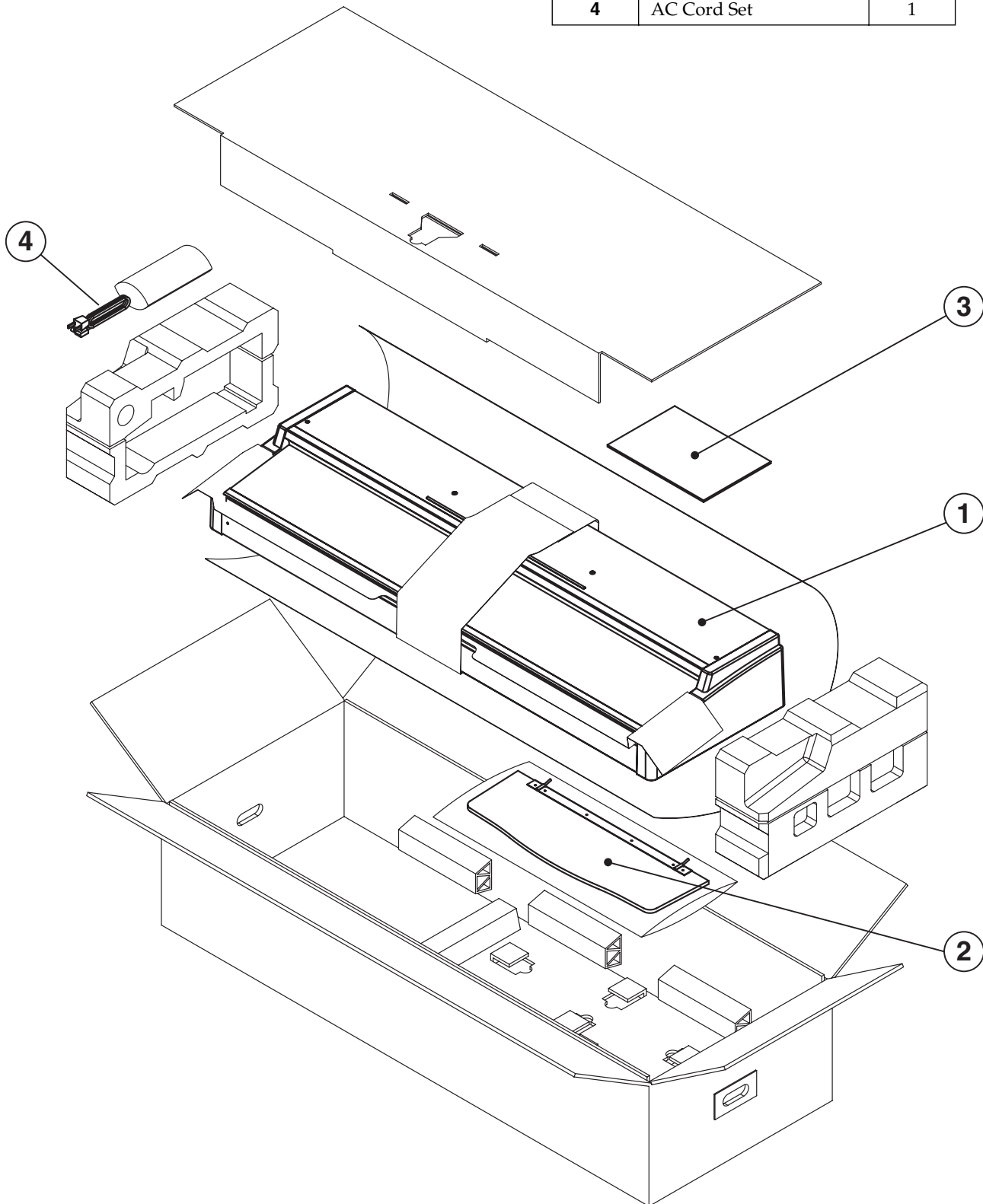

This owner's manual is printed on recycled paper.

Free Manuals Download Website

<http://myh66.com>

<http://usermanuals.us>

<http://www.somanuals.com>

<http://www.4manuals.cc>

<http://www.manual-lib.com>

<http://www.404manual.com>

<http://www.luxmanual.com>

<http://aubethermostatmanual.com>

Golf course search by state

<http://golfingnear.com>

Email search by domain

<http://emailbydomain.com>

Auto manuals search

<http://auto.somanuals.com>

TV manuals search

<http://tv.somanuals.com>