

**MONOPHONIC SYNTHESIZER**

**SH-101**

オーナーズ・マニュアル  
OWNER'S MANUAL



■SH-101は、優れた基本性能に加えて、多彩な演奏機能を装備したモノフォニック・シンセサイザーです。

●VCOの各出力波形(△,□,∩), サブ・オシレーター、ノイズが任意の割合でミキシングできるソース・ミキサー。1VCOながら豊かな音創りがおこなえます。

●最大100ステップまでの自動演奏が行なえるシーケンス機能。

●コード(和音)を押さえるだけで演奏がおこなえるオート・アルペジオ機能。

●あらゆるキー(調)への移調ができるキー・トランスポーズ機能。

●レガートでの演奏時だけ働くオート・ポルタメント機能。

●他の機器(シーケンサー、リズム・マシンなど)との組み合わせで多彩な演奏が楽しめるCV/GATE入出力ジャック(1V/1Oct)、外部クロック入力ジャック。

●DC/ACの2電源方式。(ACアダプターは別売)

★小型・軽量で、別売の専用モジュレーション・グリップとストラップ・ピンを取り付けると、肩からかけての演奏が可能!

★この楽器の持ち味をフルに発揮するためには、ツマミやスイッチなどの働きを十分に理解していただくことが必要です。またこの楽器の演奏法をはやくマスターしていただく意味でセッティングの例があげてありますが、音をクリエイトするのはあなたです。新しいセッティングや演奏法を見つけ出して下さい。

The Roland SH-101 Synthesizer offers various functions for more effective and flexible performance as well as excellent synthesizing ability.

Uncompromised sound can be obtained by mixing a waveform from the VCO(△ or □), Noise and the signal from the SUB Oscillator.

The built-in sequencer allows automatic playing of up to 100 steps.

The Automatic Arpeggio function allows automatic playing simply by pressing a chord.

Transposition to any key is possible by the Transpose function.

The Portamento Mode selector switch includes the AUTO position. In this mode a portamento effect is produced only while you are playing in a legato manner.

Provided with Output/Input jacks for CV/GATE and External Clock Input, more integral connections with other devices are made possible. (1V/1 Oct)

AC & Battery powered system is adopted.

\* This compact and light weight synthesizer can hang on your shoulder and be comfortably played, simply by attaching strap buttons and a Roland Modulation Grip (optional).

It is necessary for you to understand the function of the controls and selectors of the SH-101 perfectly to fully enjoy the advantages of the unit. Some setting examples are shown in this manual to make it easier for you to master how to operate the SH-101, but remember you are the one who creates the sounds. Please find out your own setting and new ways of playing.

基本的な接続.....P4      ご注意.....P5

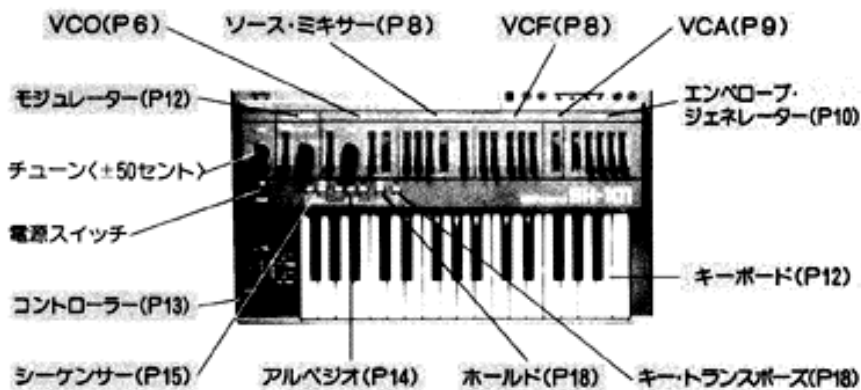

モジュレーション・グリップ.....P22      サンプル・ノート.....P52  
 電源について/電池交換のしかた.....P23      主な仕様.....P58  
 サンプル・サウンド.....P42      サービス・ステーション.....P60

Contents

Connections ..... P4      Important Notes ..... P5

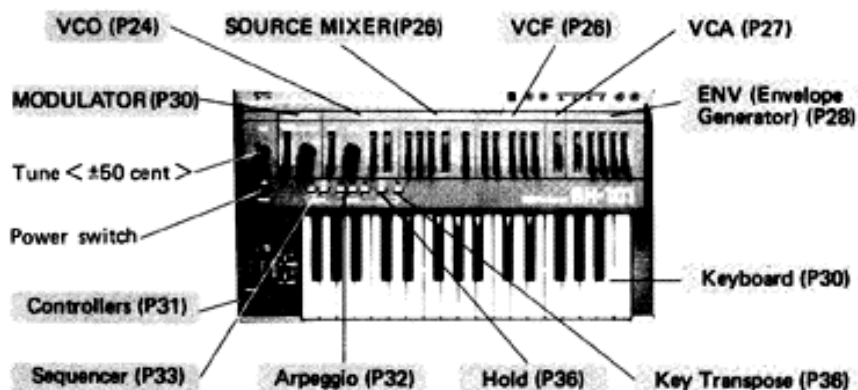

Modulation Grip ..... P40      Sound Synthesis Memo ..... P52  
 Power Supply/Battery Replacement . P41      Specifications ..... P56  
 Sample Sounds ..... P42

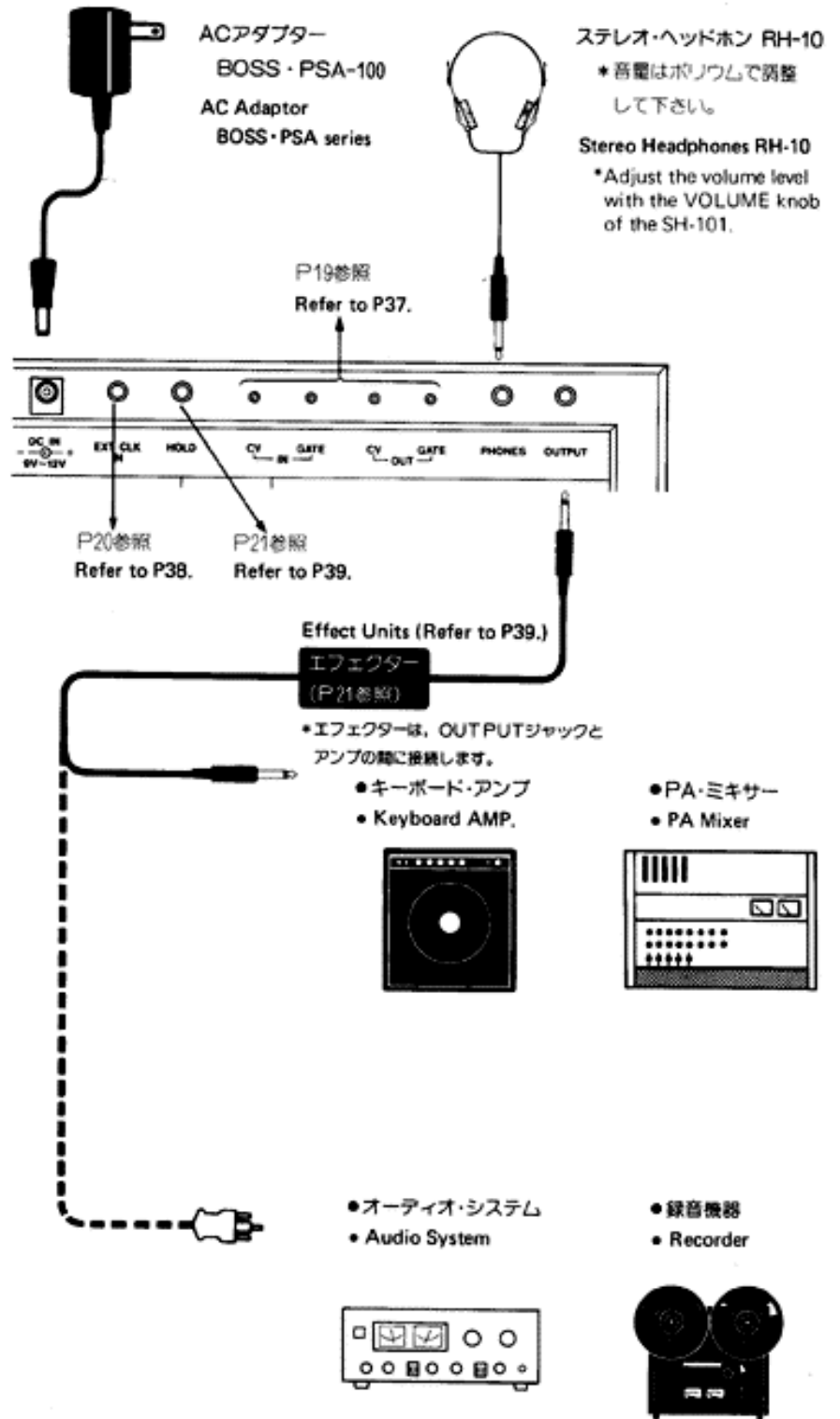

**電源について**

- この製品は、乾電池／ACアダプターのいずれでも使用できる2電源方式を採用しています。乾電池で使用する場合には、電池交換が必要となります。(P23参照)
- ACアダプターを使用する場合は、必ず専用のBOSS PSA-100をお使い下さい。**  
他のACアダプターを使用した場合、正常に動作しないばかりが故障の原因となることもあります。また、電源電圧が90V以下、または110Vを超える所では、電圧調節器で100Vにしてご使用下さい。
- 必ずアダプターの接続を終えてから、電源スイッチをオンして下さい。電源をオンにしたままでアダプターの接続を行なうと、誤動作や故障の原因となりますので注意して下さい。
- 外国でお使いになる場合は、お使いになる地域の電圧にあったACアダプター(PSA-120, 220, 240)をご用意下さい。

**設置場所について**

- 本体の近くにネオン、蛍光灯などがある場合、雑音の原因となりますので、位置を変えて下さい。
- 湿度、湿度の高い所やホコリの多い場所での使用は、故障の原因となりますから避けて下さい。
- 直射日光のあたる場所や閉めきった車の中などに長時間放置しないで下さい。キャビネットが変形することがあります。

**クリーニングについて**

- 本体が汚れた時は、中性洗剤で拭き取った後、柔らかい布で乾拭きして下さい。
- シンナー類の使用は避けて下さい。
- 電池で動作させる場合の注意➡P23参照

**Important Notes**

**Power Supply**

- The SH-101 adopts AC & Battery powered system.
- Use only the BOSS PSA series (PSA-120, 220 & 240) for AC operation.
- Do not turn the Power switch on, before connecting the AC Adaptor to the SH-101.

**Location**

- Operating the SH-101 near a neon or fluorescent lamp may cause noise interference. If so, change the angle of the SH-101.
- Avoid using the SH-101 in excessive heat or humidity or where it may be affected by direct sunlight or dust.

**Cleaning**

- Use a soft cloth and clean only with a neutral detergent. Do not use solvents such as paint thinner.

- The batteries may break out of the Battery Housing by a strong shock given in transit. Please be sure to fix the cover of the Battery Housing with tapes if moving the SH-101 without removing the batteries.

VCO  
(Voltage Controlled Oscillator)

The VCO is the Voltage Controlled Oscillator that controls the pitch, and creates

three types of waveforms which are the sound source of the synthesizer.

VCO

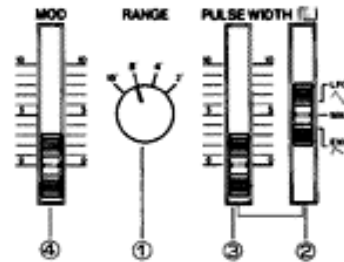

① RANGE selector knob

This is to change the pitch of the VCO in exact one octave steps from 2' to 16' (2', 4', 8', 16'). 8' is the standard, and when the knob is set to 8', the lowest C note corresponds to the Middle C of the piano keyboard. (Transpose : M)

② PWM Mode selector switch

When this switch is set to MAN, the pulse width can be controlled with the PWM Slider ③. When it is set to LFO or ENV, the intensity of the modulation is controlled with the same slider ③, i.e. the pulse width is controlled by the corresponding signal from the LFO or the Envelope Generator.

③ PWM • Pulse Width Modulation knob

④ MOD • Modulation Depth knob

When the Modulator signal is controlling the pitch of the VCO, this knob adjusts the amount of the signal (depth of the modulation). How it affects the depth of the modulation varies depending on the waveforms of the MODULATOR.

<Pulse Wave>

When the top and bottom portions of the square wave are unequal, the result is what is called a pulse wave. The harmonic content of the pulse wave will depend greatly on the width of the pulses. It is possible to modulate, or change the pulse width by means of the LFO or the Envelope Generator.





<Waveforms>

There are 2 types of waveforms from the VCO( [ ] and / ) which are sent to the SOURCE MIXER and mixed at any portion you like.

<Other Sound Sources>

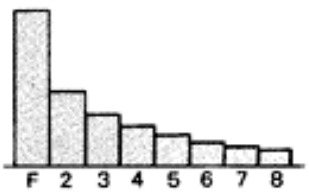
- SUB Oscillator  
This is the VCO's subordinate Oscillator which generates the output signal one octave or two lower than the VCO's. The output waveform of this Oscillator is Pulse Wave.
- NOISE

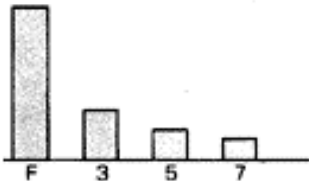
Waveform

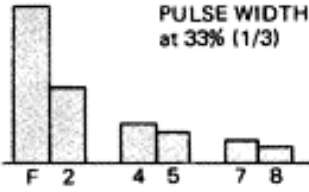
Waveform	Description	Harmonic Content
 <p>Saw Tooth</p>	<p>The sawtooth wave contains a fundamental sine wave and its integral harmonic sine waves at a fixed ratio. The level of each harmonic is as shown on the right. When fundamental content is 1, the content of <math>n</math>th harmonic is <math>1/n</math>.</p>	
 <p>Square</p>	<p>The square wave contains a fundamental sine wave and its odd numbered harmonics at a fixed ratio. The level of each harmonic is the same as sawtooth wave: the content of <math>n</math>th harmonic is <math>1/n</math>; except that there are no even numbered harmonics.</p>	
 <p>Pulse</p>	<p>With pulse wave, the harmonic content greatly varies depending on the pulse width. It is characterized by a lack of the <math>n</math>th harmonic series when the pulse width is <math>1/n</math>. The example on the left lacks 3rd, 6th, and 9th harmonics because the pulse width is <math>1/3</math> (33%).</p>	 <p>PULSE WIDTH at 33% (1/3)</p>

Pulse Width

► Manual PWM

PWM MODE SWITCH ② → MAN  
 PULSE WIDTH ③ → Determines the Pulse width.

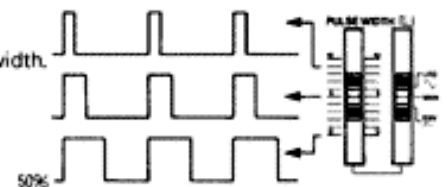

► PWM by LFO

PWM MODE SWITCH ② → LFO  
 PULSE WIDTH MODULATION ③ →  
 Adjusts the intensity of modulation.

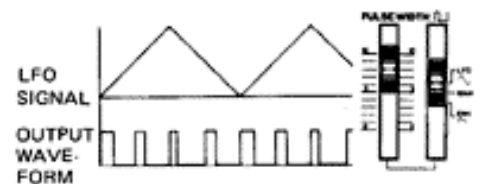

► PWM by ENV

PWM MODE SWITCH ② → ENV  
 PULSE WIDTH MODULATION ③ →  
 Adjusts the intensity of modulation.



## SOURCE MIXER

The SOURCE MIXER mixes the VCO (□ or /), SUB Oscillator, and Noise in

various proportions, before sending them to the VCF.

## SOURCE MIXER

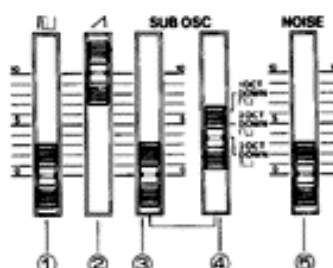

① VCO Level knob

② / Level knob

③ SUB Oscillator level knob

④ SUB Oscillator Waveform selector switch

This selects the pitch range and the waveform of the SUB Oscillator.

⑤ Noise Level knob

## VCF

(Voltage Controlled Filter)

The VCF is used to alter the tone color of the SOURCE MIXER output by cutting or boosting harmonics in that sound. The VCF is a LOW PASS filter which passes

low frequencies and blocks high frequencies, and the Cutoff Point is controlled by the voltage.

## VCF

## VCA

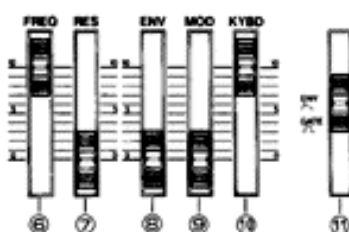

⑥ FREQ • Cutoff Frequency knob

This knob determines the Cutoff Point of the VCF. In its highest position, the sound will pass unchanged. As you lower the knob, the frequencies in the higher pitch range will be cut, thereby the sound fades out in its lowest position.

⑦ RES • Resonance knob

This knob is to emphasize the frequency at the point set with the Cutoff Frequency ⑥. As you raise the knob, certain harmonics are boosted and sound will be more unusual, more electronic in nature. If setting the Resonance knob to the high position and move the Cutoff Frequency knob, you can obtain a type of sound that is impossible to be produced by any other musical instrument. At its highest level, self-oscillation will begin (at the Cutoff Point).

⑧ ENV • ENV Depth knob

When Cutoff Point of the VCF is controlled by the output signal from the Envelope Generator, this knob adjusts the depth of the modulation. You can change the Cutoff Point of the VCF in each note with the ADSR pattern previously set. So the tone color of each note can be changed quite drastically.

⑨ MOD • Modulation Depth knob

When the Cutoff Point of the VCF is controlled by the output signal from the Modulator, this knob is used to adjust the intensity of the modulation. How it works varies depending on the waveform of the Modulator.



VCF (cont'd)

⑩ KYBD • Key Follow knob

When the Cutoff Point of the VCF is controlled by the KYBD CV (Keyboard Control Voltage), this knob adjusts the intensity of the modulation. It prevents any inconsistency in the harmonic content caused by pitch alteration. Consequently this knob is usually set to the maximum on such a long keyboard, but can be set to your taste.

Cutoff Frequency

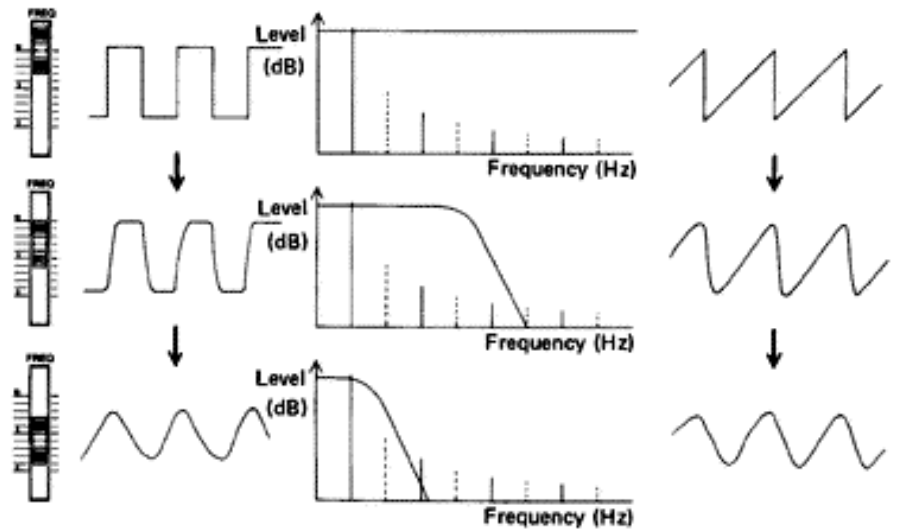

Resonance

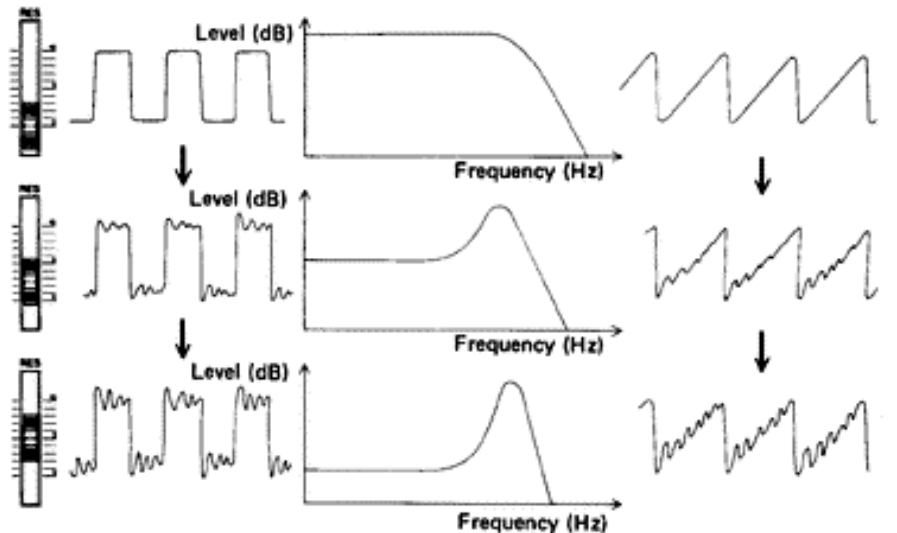

VCA

(Voltage Controlled Amplifier)

This is to control the volume (amplitude) of the sound, and is normally controlled by the output voltage from the Envelope Generator.

⑪ Selector switch for the control signal

This switch enables you to select whether to control the VCA by the signal from the Envelope Generator or by the Gate signal.

**ENV**  
(Envelope Generator)

This generates the Control Voltage applied to the VCF and the VCA, thereby controlling the volume and the tone color of each

note. This output voltage is generated whenever you press a key.

**ENV**

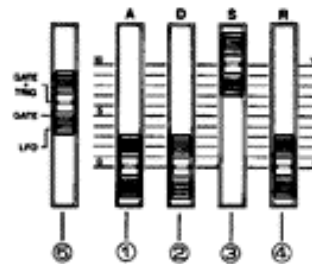

① **A (Attack time) knob**

This sets the time required for the voltage to reach its maximum from the moment the key is pressed down.

② **D (Decay time) knob**

This determines the time required for the voltage to drop from the maximum to the sustain level. When the sustain level is high, the envelope curve does not change by adjusting the Decay Time.

③ **S (Sustain level) knob**

This knob determines the Sustain Level to which the voltage falls at the end of the Decay Time.

④ **R (Release time) knob**

This sets the time needed for the voltage to reach zero.

⑤ **Gate/Trigger selector switch**

This switch lets you choose GATE + TRIG, GATE or LFO.

■ ENV

■ KYBD  
GATE

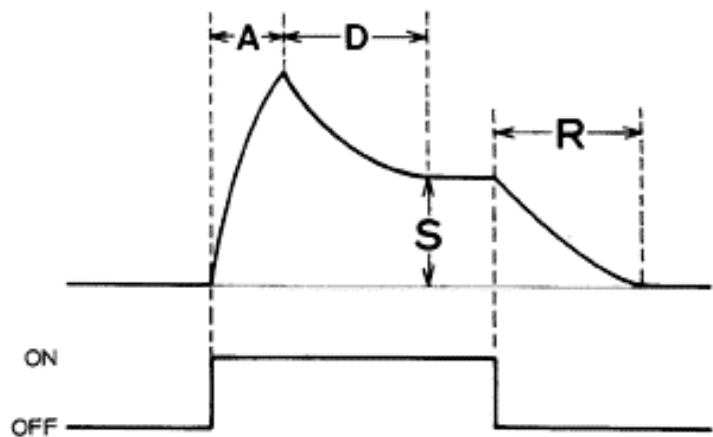

- The variation of each knob.

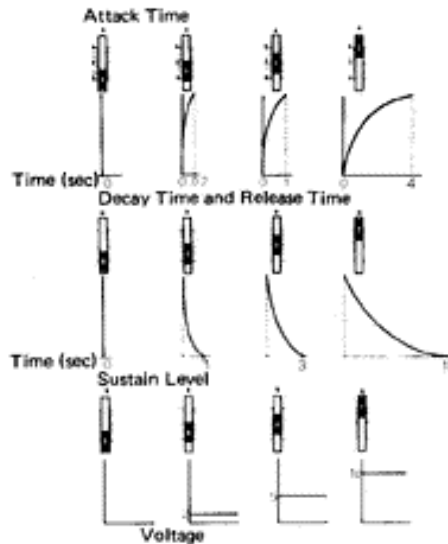

\* In the figure shown above, the positions of the knobs are not meant to be exactly correct, so the knob position does not necessarily correspond with the time and the voltage.

- Setting of ADSR and Envelope Curve.

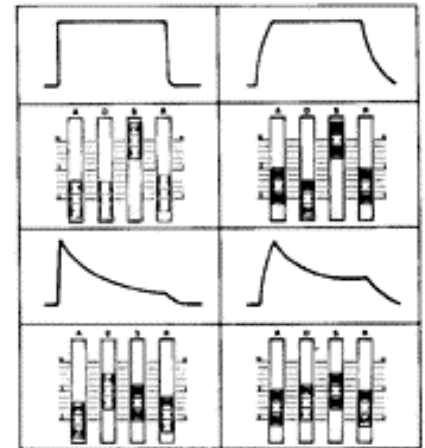

\*\* When all of the ADSR sliders are set at "0", the waveform will be an extremely short Pulse wave, and only a short "click" is heard. Please be careful.

Gate/Trigger selector switch

- With this switch in the GATE position, a new note you are pressing does not have a complete envelope shape, unless you release the previously pressed key before pressing a new key. Therefore, non-legato manner will be required to alter the tone color and the volume of each new note.
- If you press more than two keys simultaneously, the lower key will be selected according to "lower note priority".
- When this switch is set to the GATE + TRIG position, each new key you press will have a complete envelope shape, even if you play in legato manner. So, you can alter the tone color and the volume of each new note whether you play in non-legato or not.
- If you press more than two keys at the same time, the last key is selected according to "last note priority".
- When this selector switch is set to the LFO position, the envelope curve will repeat at the same rate (frequency) as the LFO rate in the MODULATOR. The envelope curve stops repeating as soon as you release the key. Also, the LFO's output waveform will always start from its head, therefore, you never fail to obtain a natural beginning of the sound.
- If you press more than two keys simultaneously, the lower key will be selected according to "lower note priority".

■ In GATE mode

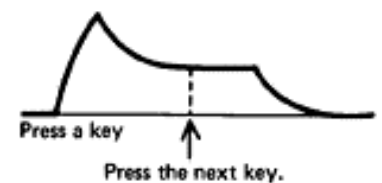

■ In GATE + TRIG mode

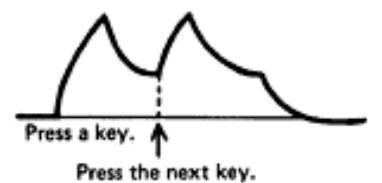

■ In LFO mode

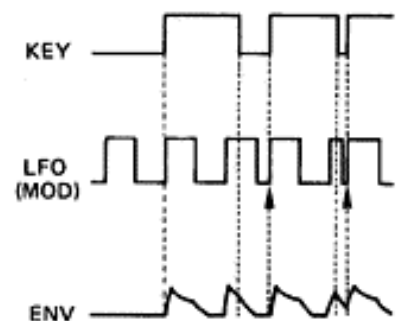

## MODULATOR

The MODULATOR, which consists of the LFO (Low Frequency Oscillator) and S/H (Sample & Hold), sends the signal controlling the VCO and VCF. Also, Noise can be selected to modulate the VCO and VCF.

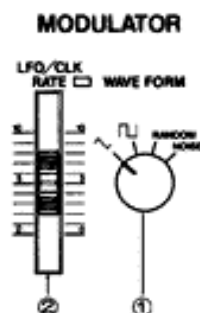

The LFO also provides the output waveform of  $\sim$  which controls the VCO and VCF by using the BENDER in the Controller Section.

## ① WAVEFORM selector switch

This is to select the output signal of the MODULATOR.  $\sim$  and  $\square$  are the output waveforms from the LFO. These modulate the VCO and VCF producing vibrato and trill (VCO), or growl (VCF). If choosing the RANDOM (output signal of S/H), the control voltage arbitrarily changing will be generated and applied to the VCO or VCF to produce the Random Note or the Random Filter. When the Noise position is selected, the noise will work as a control signal and a fast changing modulation will be obtained. (Noise Modulation)

## ② LFO/CLK RATE

This knob determines the rate (frequency) of the LFO and S/H.

• EXT CLOCK → Refer to P.38.

## Functions for Playing

## Keyboard

The SH-101 has 32 keys and 2½ octaves, but can be played as a 56 key keyboard (as shown below) by using the TRANSPOSE switch.

When the Range of the VCO is set to 8' and the TRANSPOSE switch to NORMAL, the lowest Do (C) corresponds to the Middle C of a piano keyboard.

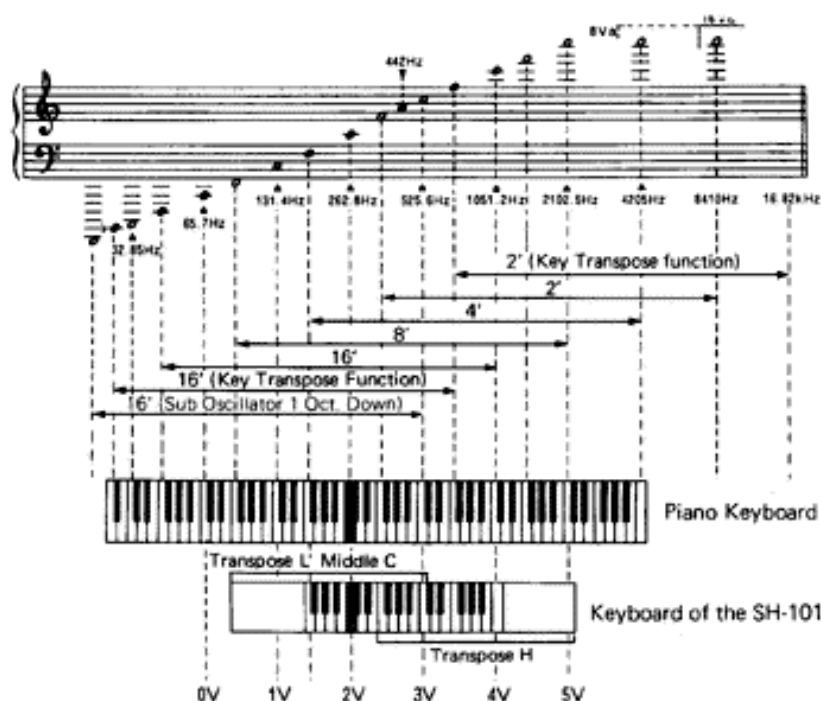

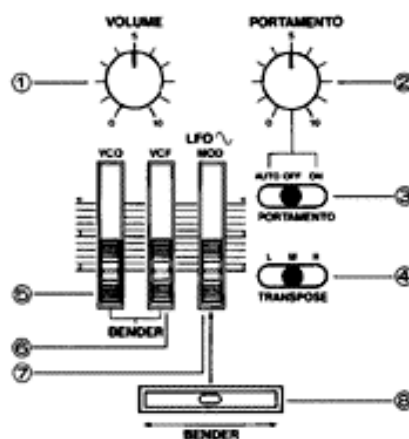

① **VOLUME knob**

② **PORTAMENTO Time knob**

Portamento is a slide from one pitch to another. This PORTAMENTO knob determines the time required to change pitches when different keys are pressed.

③ **Portamento Mode selector switch**

There are three positions to be selected depending on your requirement.

**OFF** : When the Portamento Mode switch is set to this position, the portamento effect is not available at all.

**ON** : With the Portamento Mode switch in this position, the portamento effect is always obtained.

**AUTO**: The Portamento effect is obtained only when you are playing in a legato manner (i.e. releasing the key before pressing the next key). Therefore, you can turn on or off the portamento effect depending how you play the keyboard.

- When an Arpeggio is being played, the portamento effect does not work.

④ **TRANSPOSE switch**

This switch is used to transpose the sound range one octave upper and lower. The Keyboard Follow correspondingly changes one octave upper and lower.

- When the built-in sequencer is operating, this TRANSPOSE switch does not work.

⑤ **VCO Bend Sens knob**

This slider knob sets the maximum effect of the BENDER when it is controlling the pitch of the VCO. (Max.  $\pm 1200$  cents)

⑥ **VCF Bend Sens knob**

This slider knob sets the maximum effect of the BENDER, when it is controlling the pitch of the VCF.

⑦ **LFO MOD • Modulation Depth knob**

If the BENDER lever is being pushed back, LFO  $\sim$  output controls the VCO (vibrato effect) or VCF (growl effect). This knob controls the depth of the effect.

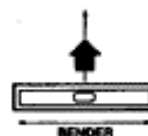

⑧ **BENDER lever**

Arpeggio

The Automatic Arpeggio is available, simply by pressing a chord.

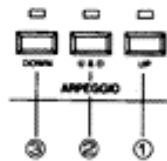

- ① UP button
- ② U&D button
- ③ DOWN button

These buttons are to determine the Arpeggio pattern.

- **LFO/CLK RATE**  
This knob determines the tempo of an Arpeggio.
- ★ (EXT CLOCK) Refer to P. 38.

<Note>

- If you fail to press each key of the chord at precisely the same moment, the first pattern of the Arpeggio may prove imperfect.
- An Arpeggio can only play while the keys are being held down, unless the HOLD button is pressed.

► **How to obtain Automatic Arpeggio**  
Press any one of the UP, U&D, DOWN buttons (the indicator lights up), then press a chord, and Arpeggio patterns will be played.

★ An Automatic Arpeggio is available only when you press a chord. When you press a single tone in non-legato manner, it will prove a normal playing. Thus, you can obtain either an auto-arpeggio or a normal playing depending how you play the keyboard.

► **How to cancel the Automatic Arpeggio**  
Press the button again, and the SH-101 will return to a normal playing condition.

• How an Arpeggio is played varies depending on which position the GATE/TRIG selector switch of the Envelope Generator is set to.

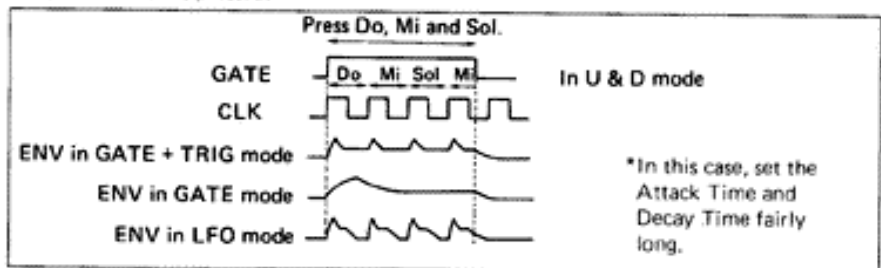

- With the GATE/TRIG selector switch set to the GATE position, if ADSR are set to generate decay sound (piano-like sound, i.e. S=0), the sound will quickly vanish.

Arpeggio & Extra functions

Arpeggio & Portamento

When the Portamento Mode selector switch is set to the ON position, the portamento effect is available. When it is set to either AUTO or OFF, it will not work.

Arpeggio & Hold

If you press the Hold button while an Arpeggio is being played, it will continue to be played even after the keys are released. In this condition, if you press a new chord, a new Arpeggio pattern will be played.

Arpeggio Hold & Key Transpose

Refer to P. 36.

## Sequencer

The SH-101 contains a digital sequencer which can store and play up to 100 steps. When you wish to load the notes, divide the longer time values by the shortest time value (Refer to the example shown below).

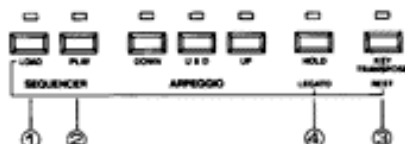
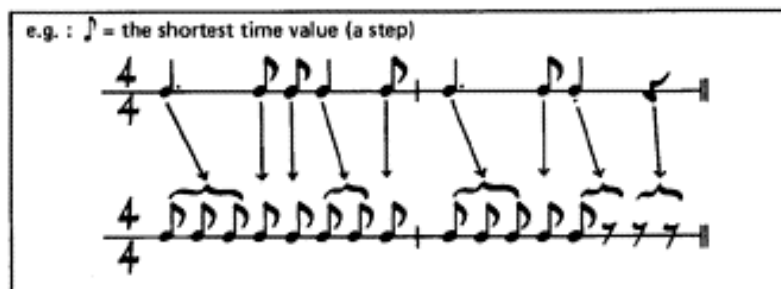

## ① LOAD button

Press this button when you wish to store notes, and press it again to stop storing.

## ② PLAY button

Press this button when you wish to play the stored notes, and press it again to stop playing.

## ③ REST button (This works only in LOAD mode)

Press this button when you are storing rests.

## ④ LEGATO button (This works only in LOAD mode)

Press this button when you wish to store a slur or tie.

## ● LFO/CLK RATE

The tempo of the sequencer can be controlled by the LFO/CLK RATE in the Modulator section.

★  (EXT CLOCK) Refer to P.38.

## &lt;Note&gt;

You can load into the built-in sequencer only from the keyboard of the SH-101. Loading from any other unit is impossible.

## Loading

Press the LOAD button (the indicator lights up) and play the keyboard, only the pitches of the notes played will be stored. No matter how you play, the time values will turn out the same. How you regard this time value (♩, ♪ or ♫ etc.) is entirely up to you, but this should be regarded as the shortest time value.





Long time values, rests and legato playing can be also stored. (Refer to the table shown in the next page)

Press the LOAD button again when the loading is completed.







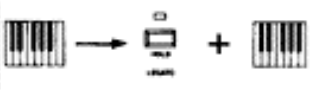



Loading (cont'd)

<BASIC> ★ In this example, a 1/4 note is regarded as the shortest time value (a step).

		No matter how you play the notes, all will be stored in the same time values.
		Press the REST button, the shortest rest will be memorized.
		Load the first note, then press the next note while holding the LEGATO button down.

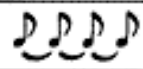
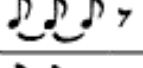
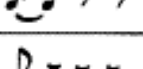
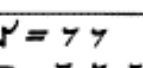
<APPLICATION>

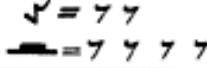
		
		
		The impression of the melody varies depending which pattern you choose. Also, the setting of the Envelope Generator affects the sound. Select the appropriate pattern and setting according to your taste*. * This does not apply to the decay sound whose sustain level is zero.
		
		
		
		Press the button as many times as needed.

———— Now you have set the length of notes and rests.

- ★ This sequencer can store up to 100 steps, but the shortest time value is counted as one step, and the longer time values cost more steps.
- ★ If all 100 steps are stored, the SH-101 will return to normal playing condition, even if the sequencer is in LOAD mode.

- ★ Transpose function is available with the TRANSPOSE switch in the Controllers Section. Thereby, the total pitch range available for storing comes to 56 keys.

Playing

- ★ Press the PLAY button (the indicator lights up), the notes stored previously will be played. All are played in non-legato except for those stored in a legato manner.
- ★ When the last note is played, it will go back to the beginning of the piece and be repeated until you press the PLAY button again. Tempo is controlled by using the LFO/CLK RATE knob.

- ★ When storing slurs, remember to set the GATE/TRIG selector switch in the Envelope Generator to the GATE position before playing.
- ★ When the Hold Pedal (Refer to P.39) is being used, you can stop the sequence by stepping on the Pedal and releasing it.



Playing (cont'd)

\* In case there are only the shortest time values and no star, a slightly different type of sequence is available by setting the GATE/TRIG selector switch in the Envelope Generator to the LFO position.

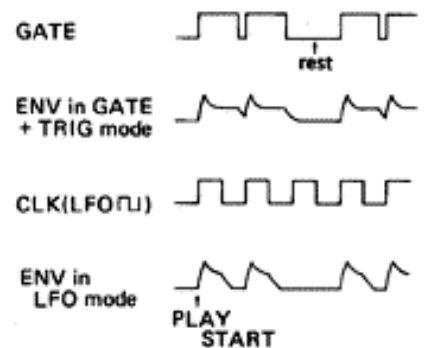

Correcting and Adding (Editing)

If you wish to correct or/and add some more to the data you have stored, run the sequencer just before the part you want to change, and while the very last note is

being played, press the LOAD button. (Setting the LFO/CLK Rate to slow makes the operation easier.) Then start re-loading in the same way as usual loading.

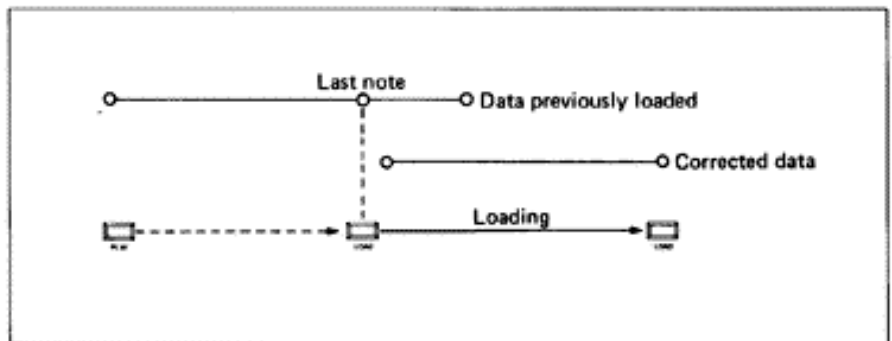

<NOTE>

When the corrected data are shorter than the data previously loaded, there will be the old data still left and played.

If you start re-loading from the beginning, the previous data will be all cancelled immediately (automatically).

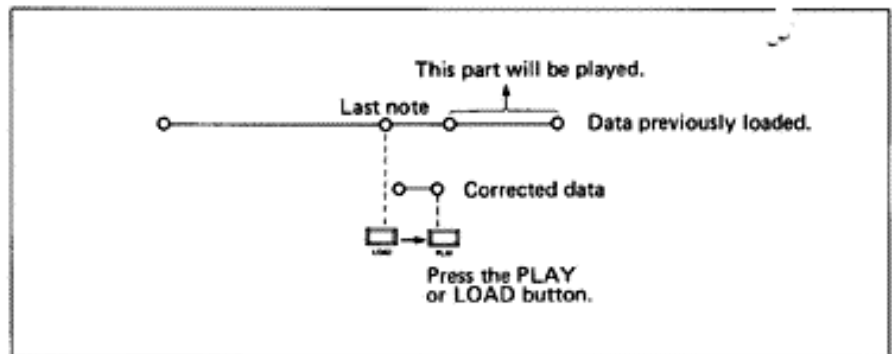

Sequencer Play & Extra function

Sequencer Play & Key Transpose

Refer to P.36.

\* The BENDER and PORTAMENTO work even while the sequencer is operating.

## Hold

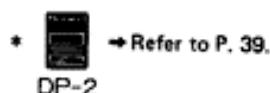

You can hold the sound even after the key is released, by pressing the HOLD button (the indicator lights up). The level of the sound is determined by the Sustain level of the Envelope Generator. Therefore, Hold function is not obtained if the Sustain level is zero (Decay sound). The Pedal Switch (DP-2, sold separately) functions like a damper pedal of a piano.

## Hold &amp; Extra functions

## Arpeggio &amp; Hold

Refer to P. 32.

## Arpeggio, Hold &amp; Key Transpose

Refer to "Key Transpose button" shown below.

## Key Transpose



Transposition to any key is possible. By using the appropriate key, you can shift the pitch of the entire keyboard. Moreover you can play a piece with many ♯'s and ♭'s in the key of C major (A minor).

## ► How to transpose

While holding the TRANSPOSE button down, press any key except for the lowest C key. If the indicator above lights up, transposition is completed and the SH-101 will now play in the key of the chosen note.

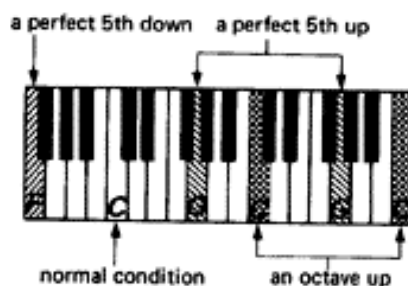

1. If you press a key lower than the lowest C, it will be transposed down by the distance in pitch between the pressed key and the C.  
e. g. If you press the lowest F, it will be transposed down by a perfect 5th.
2. If you press a key higher than the lowest C, it will be transposed up by the interval between the pressed key and C.  
e. g. If you press any G key, it will be transposed up by a perfect 5th. When you press the two upper C keys, it will be transposed up by an octave.

## ► How to return to the normal key (C key)

While holding the TRANSPOSE button down, press any C note (except for the highest C), and the indicator will go out and the SH-101 has returned to the normal condition (the key of C).

## Key Transpose &amp; Extra functions

## Hold &amp; Key Transpose (Arpeggio, Hold &amp; Key Transpose)

The sound, sustained by the HOLD function, can be transposed as well. Also an Arpeggio playing can be transposed while it is in HOLD mode.

## Sequencer Play &amp; Key Transpose

You can also transpose the sequence being played by using the TRANSPOSE button.

## &lt;Note&gt;

Transposition by this Key Transpose function does not apply to the Key Follow in the VCF. Please be careful when using the VCF Oscillation as a sound source.

## CV/GATE IN & OUT

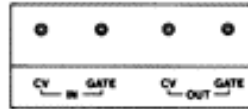

### CV/GATE OUT

These are the CV/GATE output jacks for the keyboard and the built-in sequencer. They are used to control an external synthesizer or to send a signal to an external sequencer (1V/1 Oct). The Octave transpose and Arpeggio functions are available.

### CV/GATE IN

This jack is used to drive the SH-101 (Synthesizer Module) from an external unit (1V/1 Oct). The Key Transpose, Portamento and Bender functions of the SH-101 are available.

### [1] SH-101 + External Synthesizer

The SH-101 can control an external unit such as the SYSTEM-100M or the SH-2.

Also, you can drive the SH-101 by the keyboard of an external synthesizer.

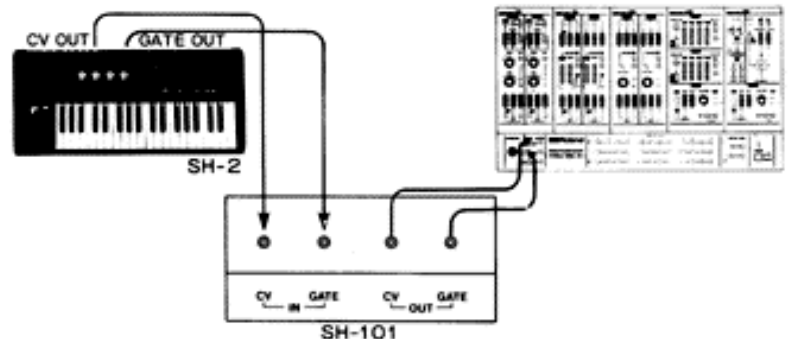

### [2] SH-101 + Digital Sequencer

Wider capacity of sequence is available by using CSQ-100, 600 or the MC-4 Microcomposer, instead of the built-in sequencer.

★ As soon as the external unit is connected to the CV IN and GATE IN, internal connection of CV and GATE will be automatically cut.

★ Use the PCS-4 connection cord (Optional), if you are using the unit provided with 1/4 phone jack (e.g. CSQ-600).

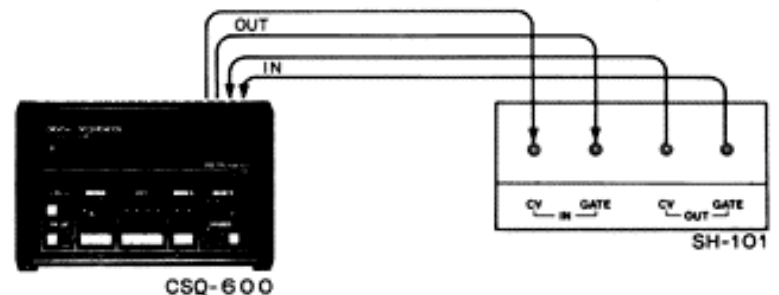

★ As soon as the external unit is connected to the CV IN and GATE IN, internal connection of CV and GATE will be automatically cut.

★ Use the PCS-4 connection cord (Optional), if you are using the unit provided with 1/4 phone jack (e.g. SH-2).

EXT CLK IN

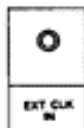

- ★ As soon as you connect a plug to this jack, internal connections of built-in clocks are out. The LFO / CLK RATE Knob in the MODULATOR section controls only the rate of the LFO.

[1] SH-101 + External Clock

If you connect an external unit to the CLK IN jack of the SH-101, the Arpeggio playing or built-in sequencer of the SH-101 will synchronize with the external unit.

- ★ When the external unit is connected to the EXT CLK IN jack, the Arpeggio RATE Knob on the Front Panel does not function.
- ★ You can enjoy various kinds of Arpeggio patterns.

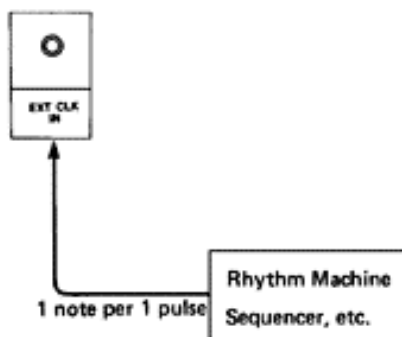

- CR-8000.5000 ..... TRIGGER OUT
- DR-55 ..... DBS, CSQ\*
- TR-606.808 ..... TRIGGER OUT\*
- TB-303 } ..... GATE OUT\*
- CSQ-600 }
- MC-4 ..... GATE OUT\*
- MPX OUT\*

\* Wide variations of Arpeggio Patterns are available.

[2] Applied Connections (of the SH-101)

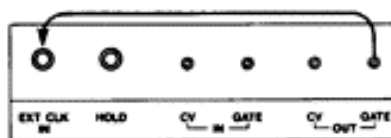

\* Use the PCS-4 (optional).

Connect the GATE OUT to EXT CLK IN. Set the waveform selector in the MODULATOR to the RANDOM position. The random S/H signal modulates the VCF and the Cutoff Point changes in each note,

allowing random alteration of the tone color. (Setting the RESONANCE to high level might prove interesting)

- ★ Use the PCS-4 (sold separately)

HOLD







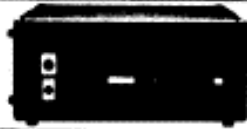

If the Pedal Switch DP-2 (sold separately) is connected to the HOLD jack, you can turn on or off the Hold function by pressing the Pedal. The Hold function is on, just while the Pedal is being pressed. You can use the Hold button on the Front Panel, too.

EFFECTS ( ← output)

An echo chamber is most commonly used of all the effect units. It has such a strong effect that it is often said to be indispensable when using synthesizers. Effect units such as a Phase and Flanger have the ability to add unique changes to the sound, and it is effective to use them with Echo Chamber.

A Phaser gives an effect which can change the noise to a jet sound. A Flanger has an effect similar to a Phaser's, but stronger, and can give power to a synthesizer bass sound. Use the stereo output (2ch) to obtain the best effect.

Echo Chamber		SRE-555 RE-501 RE-201 RE-150
Delay Machine		DC-30 DM-100
Digital Delay		SDE-2000
Phaser/Flanger		SPH-323, PH-1R SBF-325, BF-2
Equalizer		SEQ-331, SEQ-315 GE-10, GE-7
Reverb		RX-100
Chorus		CE-2, CE-3 SDD-320

## Modulation Grip MG-1 (OPTIONAL)

This compact and light weight synthesizer SH-101 is designed to hang on your shoulders and be played comfortably, just by attaching strap buttons, the strap and the Roland Modulation Grip MG-1 (MGS-1, optional).

### • How to fix

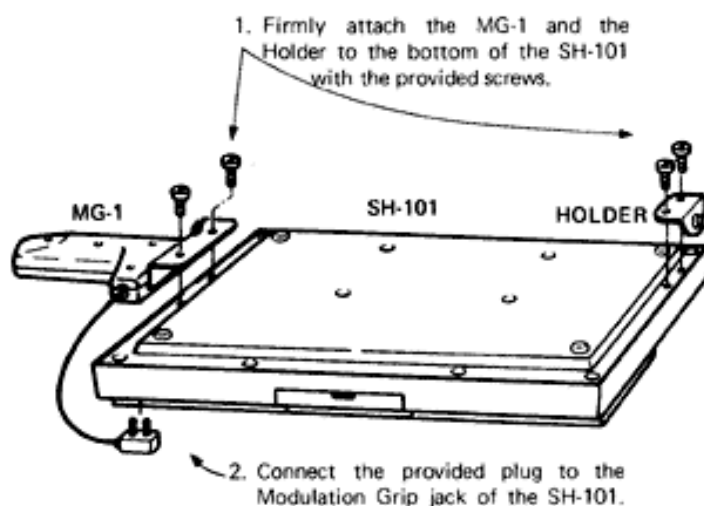

### • How to operate

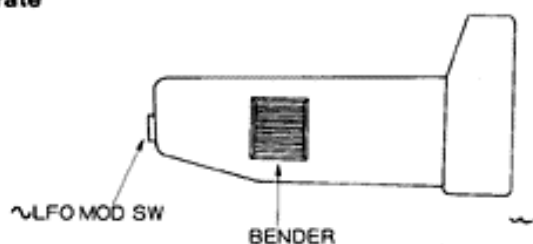

#### Bender

This Bender has the function of an ordinary bender, i. e. changes the tone color and the pitch, but works only in upper direction (to higher pitch and brighter tone color). You can use this Bender to produce the guitar choking-like sound. The maximum effect of the Bender is controlled by using the Bend Sens.

★ Bender lever of the SH-101 works, too.

#### LFO Modulation button

By pressing this button, you can obtain the same effect as produced by pushing the Bender lever of the SH-101, i.e. LFO  $\sim$  waveform modulates the VCO (vibrato) and VCF (growl). By using this button together with the Bender, the Choking-Vibrato effect can be produced. The intensity of the modulation is adjusted with the Moduration Depth knob in the Controllers section of the SH-101.

★ The Bender lever of the SH-101 also works.

## Power Supply/Battery Replacement

41

### Power Supply

- The SH-101 adopts AC and Battery Powered System.
- Do not turn the Power switch on before connecting the AC Adaptor to the SH-101. Connecting the AC adaptor while the Power is on may cause troubles.

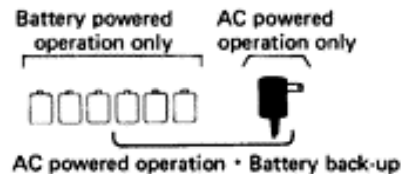

- Be sure to keep the batteries in the housing even when using an AC adaptor. Then, if the AC adaptor is disconnected, operation immediately changes to battery, allowing the sequencer's data to be retained.
- When using an AC adaptor, use only the BOSS AC Adaptor PSA-120, 220 or 240 depending on your country's voltage system.
- If you wish to protect the sequencer data after the Power switch is turned off, use 3 batteries. When operating the SH-101 only by batteries, use 6 batteries. The sequencer data will be retained.

### Battery Replacement

- Replace the batteries with a complete set of new ones when the Battery Check indicator flashes. If you fail to replace the batteries within one hour, the SH-101 will stop operating properly.
- The batteries last for approximately 10 hours when using only battery power. (It varies depending on the type of the batteries, how often the unit is used, etc.)

- The indicator flashes at the same rate as the LFO/CLK rate, therefore, if the rate is set too slow or too fast, you may fail to notice the flashing.
- If using the batteries just for a back-up circuit to protect the memories, battery replacement is required just once a year.

1. Turn the Power switch off. If using an AC adaptor, disconnect the power cord.
2. Remove the cover from the battery housing and take out the batteries.
3. Replace with new batteries.

- Make sure that the polarity of the battery is correct.
- Place the three batteries in the front part of the housing. (A). In this case, place to the sides, then in the middle. If using only three batteries for retaining the sequencer memory, put the batteries in the back part of the housing. (B).

4. Put the cover back to the housing.

- If the batteries are changed within one minute, the memory will hold the sequencer data.

#### IMPORTANT NOTES

- When the SH-101 is not to be used for long periods, remove the batteries to prevent leakage.

- When the SH-101 is operating by battery power, be sure to turn the Power switch off when it is not in use (to prevent unnecessary consumption of the batteries.)

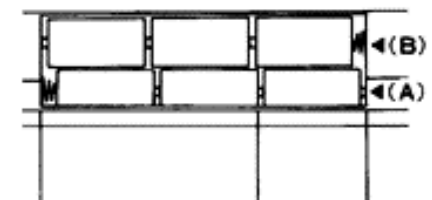
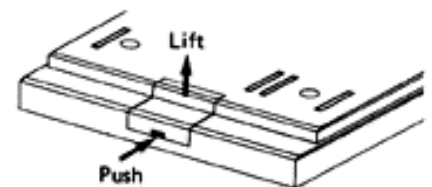

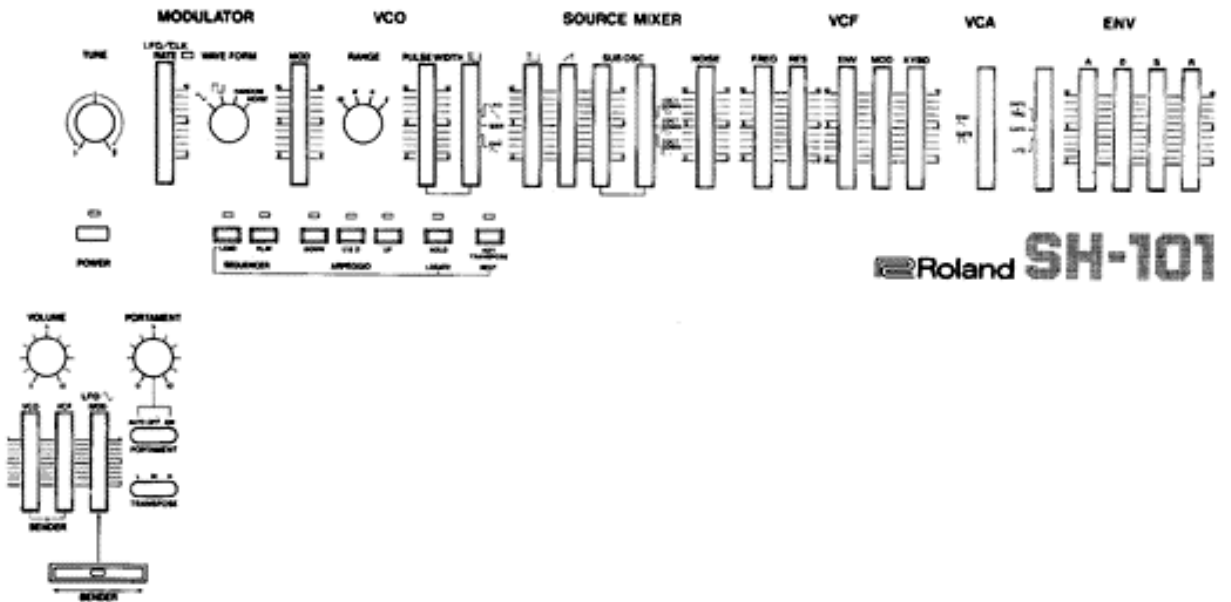

Roland SH-101

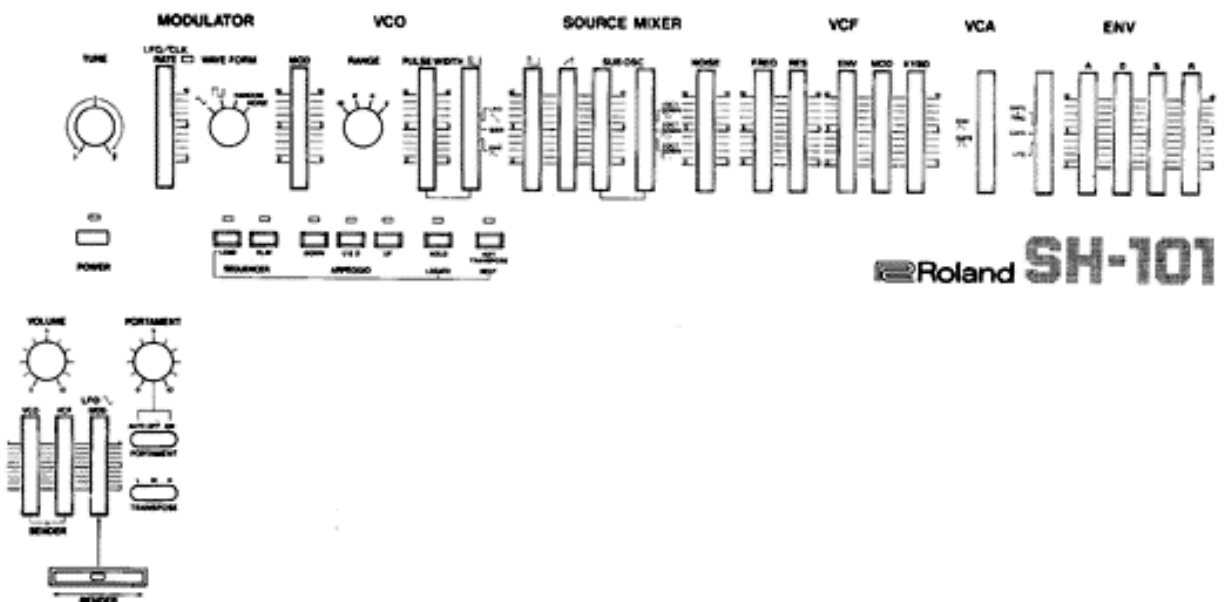







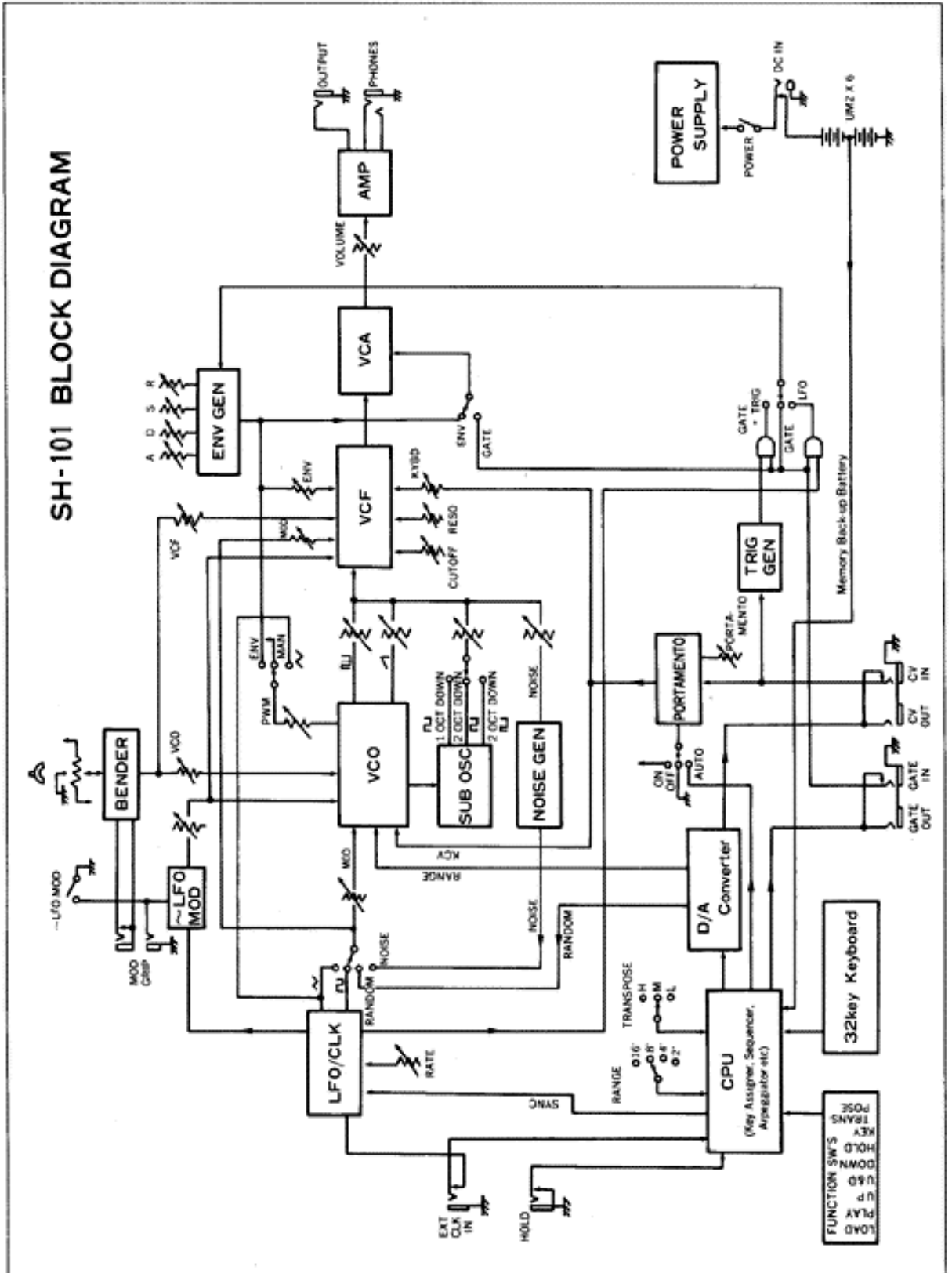



Roland SH-101



# SH-101 BLOCK DIAGRAM



<b>• SH-101</b>	<b>• Monophonic Synthesizer</b>
Keyboard	32 key, F-scale
VCO	Range selector knob (16', 8', 4', 2') Pulse Width Modulation knob (50% ~ min.) PWM Mode selector switch (ENV/MANUAL/LFO) Modulation Depth knob Tune knob (±50 cent)
Source Mixer	 Level knob  Level knob SUB Osci Level knob SUB Osci Waveform selector switch (1 OCT Down  /2 OCT Down  /2 OCT Down  ) Noise Level knob
VCF	Cutoff Frequency knob (10Hz ~ 20kHz) Resonance knob (0 ~ Self-Oscillation) ENV Depth knob Modulation Depth knob Key Follow knob (0 ~ 100%)
VCA	ENV  /GATE  selector switch
ENV	Attack Time knob (1.5ms ~ 4s) Decay Time knob (2ms ~ 10s) Sustain Level knob (0 ~ 100%) Release Time knob (2ms ~ 10s) Gate-Trigger selector switch (GATE + TRIG/GATE/LFO)
Modulator	LFO/CLK RATE (0.1Hz ~ 30Hz) Rate Indicator Waveform (  /  /RANDOM/NOISE) selector switch
Controller	Volume knob Portamento Time knob (0 ~ 5s) Portamento Mode selector switch (AUTO/OFF/ON) Transpose switch (L/M/H) VCO Bend Sens knob VCF Bend Sens knob LFO  MOD knob Bender lever (with LFO MOD SW)
Sequencer (100 steps max.)	LOAD button and indicator PLAY button and indicator
Arpeggio	UP button and indicator U & D button and indicator DOWN button and indicator
Hold	HOLD button and indicator
Key Transpose	KEY TRANSPOSE button and indicator
Connection Jacks	Output jack (0dBm max.) Phones jack (8Ω, STEREO) Gate Output jack (OFF - 0V, ON - 10V at 100kΩ load) CV Output jack (1V/1 OCT, 0.415V ~ 5V) Gate Input jack (+2.5V or more) CV Input jack (1V/1 OCT, 0 ~ 7V) Hold Pedal jack (DP-2) EXT CLK Input jack (+2.5V or more) DC Input jack (9V ~ 12V/Adaptor: PSA-120, 220, 240) Modulation Grip Connection jacks
Power	UM2 Battery x 6, AC Adaptor (PSA-series)
Power Consumption	1W
Dimensions	570(W)X 311(D)X 80(H)mm / 22 <sup>3</sup> / <sub>8</sub> (W) x 12 <sup>3</sup> / <sub>8</sub> (D) x 3 <sup>1</sup> / <sub>8</sub> (H) in.
Weight	4.1kg/9lb (without batteries)
Accessory	2.5 m connection cord , BR-2 (UM2) x 6

Specifications are subject to change without notice.

- Headphones  
RH-10



- Pedal Switch  
DP-2



- AC Adaptor  
PSA-120, 220, 240



- Modulation Grip Set MGS-1
  - Modulation Grip MG-1 x 1
  - Strap x 1
  - Holder with a strap button x 1
  - Screws x 4

- Carrying Case  
SC-101



## Free Manuals Download Website

<http://myh66.com>

<http://usermanuals.us>

<http://www.somanuals.com>

<http://www.4manuals.cc>

<http://www.manual-lib.com>

<http://www.404manual.com>

<http://www.luxmanual.com>

<http://aubethermostatmanual.com>

Golf course search by state

<http://golfingnear.com>

Email search by domain

<http://emailbydomain.com>

Auto manuals search

<http://auto.somanuals.com>

TV manuals search

<http://tv.somanuals.com>