

 **ROLAND SYNTHESIZER**

SH-3
INSTRUCTION MANUAL

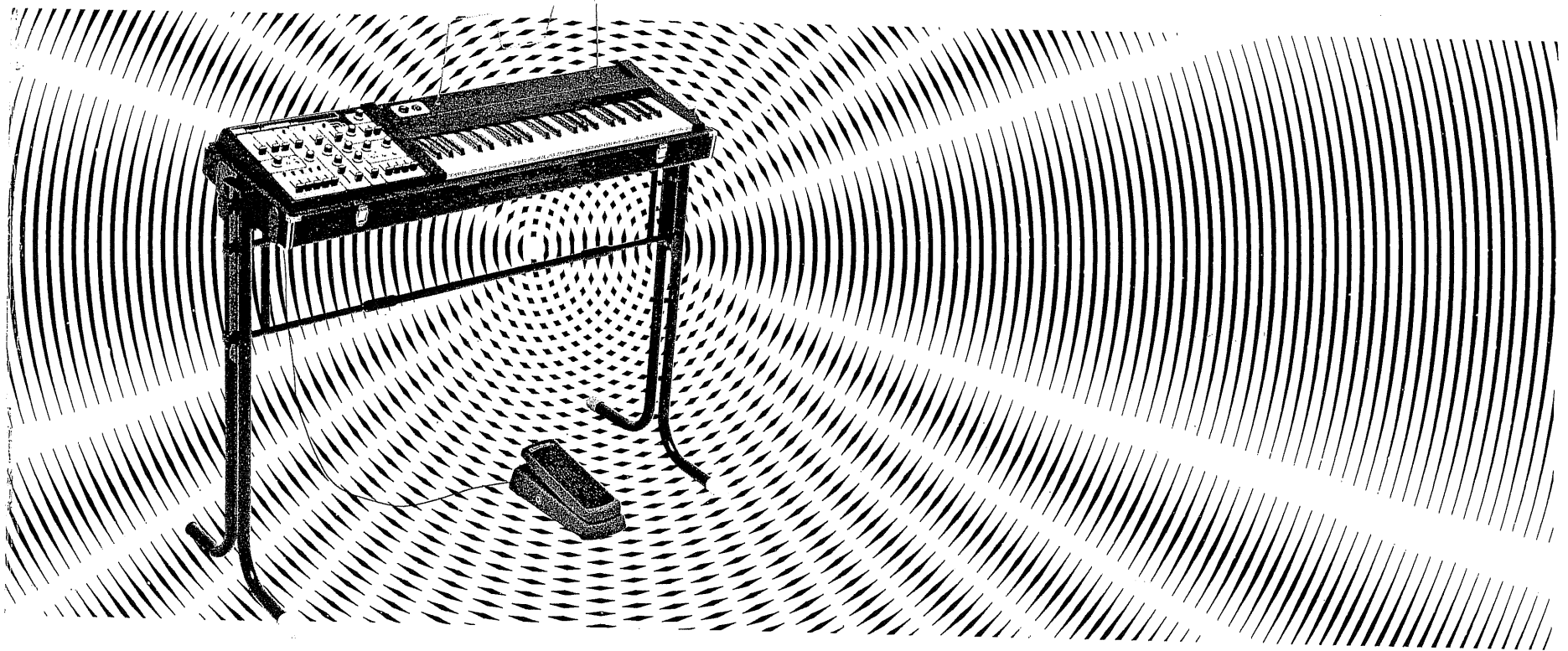

 Roland
Corporation

SH-3

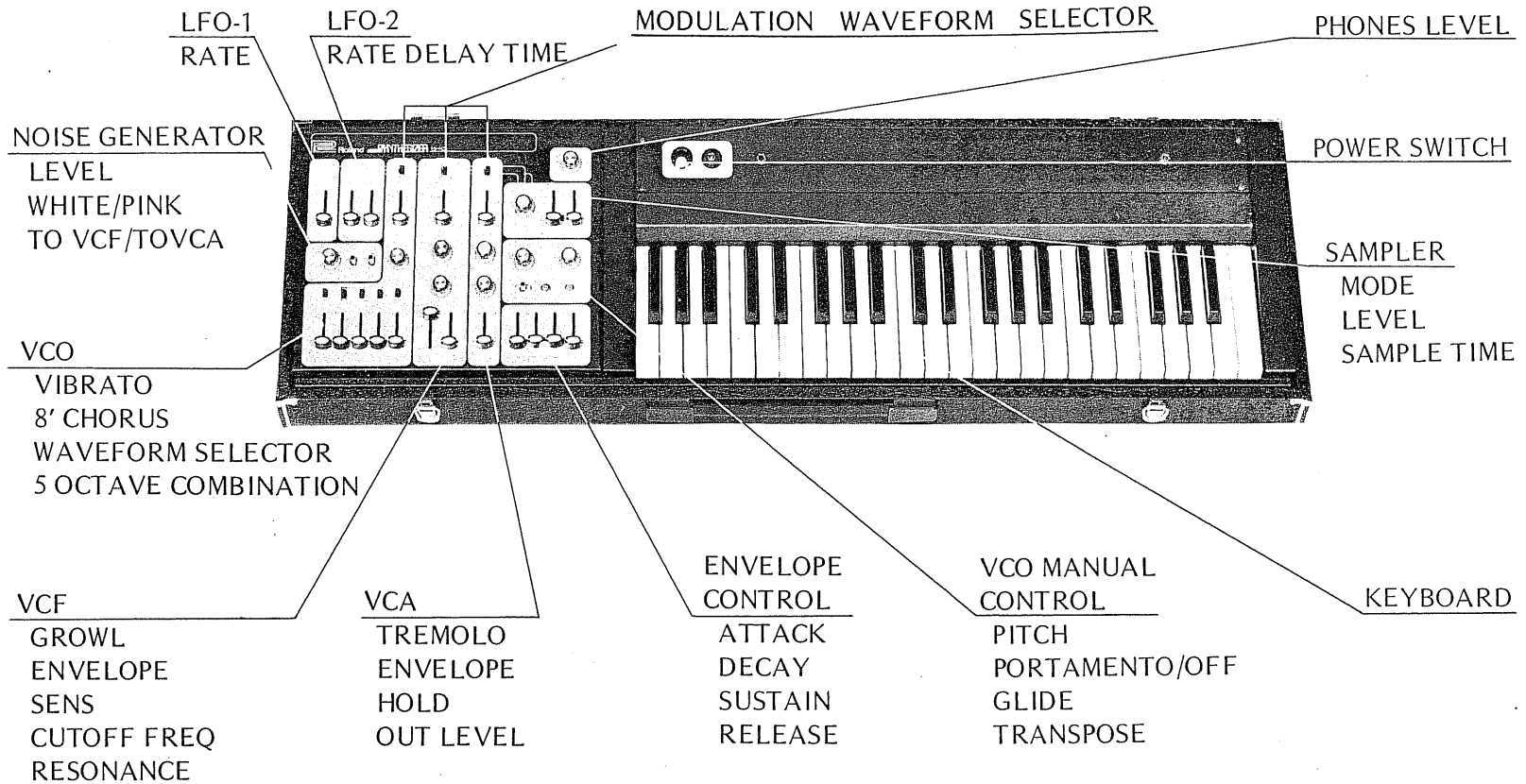

Contents

1. Introduction
2. Theory of the Synthesizer
3. Function of the SH-3
 - a) Keyboard
 - b) VCO (Voltage Controlled Oscillator)
 - c) VCF (Voltage Controlled Filter)
 - d) VCA (Voltage Controlled Amplifier)
4. Operation
5. Tuning
6. Accessories (Optional)

1. Introduction

A synthesizer is not an organ. The basic difference lies in the synthesizer's ability to freely modify sound envelopes, or, in other words, radically alter the quality of musical sounds.

The synthesizer can modify sound envelope elements to change envelope characteristics and thus modify volume and tone to synthesize many sounds which are unlike any which can be produced by conventional instruments, in addition to sounds which are exactly like those of conventional instruments.

Thus, the Synthesizer has the inherent capability of extending the range of musical conception through production of unique new sounds.

2. Theory of the Synthesizer

The Voice Generator, which generates electronic signals that play an important role in all electronic musical instruments, is composed of the VCO "Voltage Controlled Oscillator", and its musical interval is controlled by the voltage coming from the keyboard switch. As the wave form of the music sound produced by the VCO has many harmonics, the desired tone is produced through a VCF or "Voltage Controlled Filter".

The function of the Filter is also dependent on the voltage. The signal through the VCF is modified with regard to the rising, falling or the maintaining of sound by the function of the VCA "Voltage Controlled Amplifier".

Consequently, the VCO, VCF and VCA are the crux of Synthesizer operation.

There are included various kinds of voltage generators to modify these three circuits. For example, the LFO (Low Frequency Oscillator) generates an electronic oscillation lower than audio-frequency and supplies voltage to the VCO for Vibrato, to the VCF for Growl, and to the VCA for Tremolo functions. And a SAMPLER incorporating a different LFO taps at regular intervals the input voltage produced by the first mentioned LFO or random voltage produced by the Noise Generator and supplies this voltage into the VCO to create special sounds regardless of individual keyboard notes.

The Envelope, comprising elements Attack (A), Decay (D), Sustain (S) and Release (R), as shown in Figure 1 in general form, can be varied according to operation control.

Two basic kinds of envelopes can be produced, namely AR and ADSR. The ADSR and AR are also called Envelope Generators. Fig. 2 shows the mutual relation among VCO, VCF, VCA, LFO, SAMPLER, and ADSR. This is the general theory of Synthesizer operation. Of course, besides the abovementioned, there is other function — namely, white-noise generator. Synthesizing these functions in many ways creates even more complicated and more unique sounds.

Fig. 1

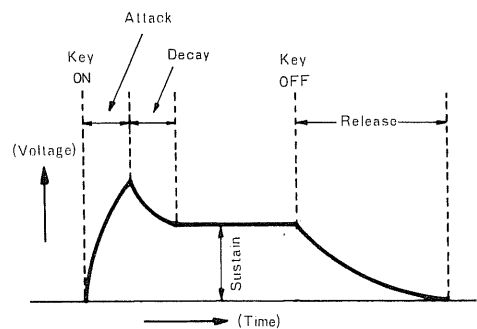
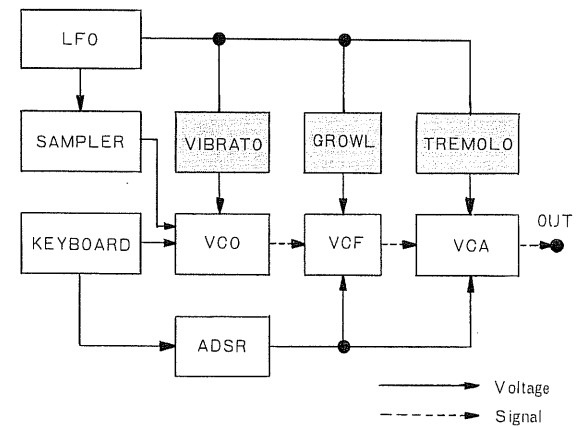

Fig. 2



3. Function of the SH-3

VCO

a) Keyboard

The keyboard employs F scale, 44 keys and 3½ octaves. It is possible, however, to raise or lower notes by one octave via the Transpose changeover switch to actually extend the keyboard function to 68 keys (9½ octaves are possible by adjusting the VCO).

Due to the employed “low-tone-take-precedence” system, when two or more keys are depressed simultaneously, the lowest tone only is produced. When a key is depressed, a voltage which identifies the tone of the key is supplied to the VCO and at the same time, another fixed voltage is supplied to the ADSR to form an envelope.

b) VCO (Voltage Controlled Oscillator)

The VCO of the SH-3 comprises volume knobs and change-over switches as shown in Fig. 3.

- Symmetric Rectangular Wave . . . Contains odd harmonics (3, 5, 7, 9 . . .) to produce clarinet-like sounds.
- ▤ Unsymmetrical Rectangular Wave . . . Contains many high-tone harmonics.
- ∧ Pulse Wave . . . Contains many high-tone harmonics to produce string sounds like a violin.

Each foot-volume knob (32' to 2') is equipped with an output-wave-form selector to produce compound wave forms without limitation.

Turning the 8' CHORUS dial clockwise quickens the beat of chorus.

Fig. 3

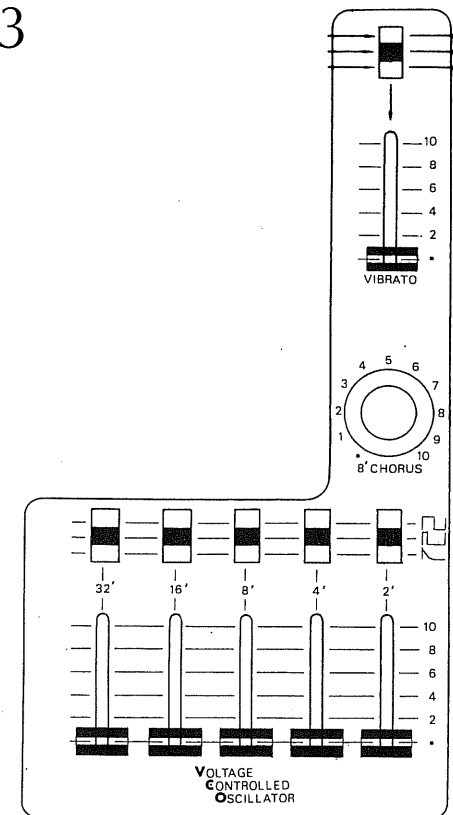

VCF

o VIBRATO

By shifting the VIBRATO knob, depth is changed and normal vibrato can be modulated by the “~” wave form. However, if it is modulated by other wave forms, special vibrato effects can be produced. Vibrato speed can be changed by shifting the RATE knob for LFO.

Pitch, Portamento and Glide of VCO can be controlled by VCO MANUAL CONTROL. (See Fig. 4).

o PITCH

The PITCH dial can vary the musical interval by perfect fifth.

o GLIDE

When pushing the GLIDE button while playing, the musical interval drops, and as soon as the button is released, the musical interval is gradually restored.

This produces a Hawaiian guitar effect.

o PORTAMENTO

The PORTAMENTO effect is obtained by turning the PORTAMENTO dial. When using

PORTAMENTO effect, one note drifts to the subsequent note. This changing speed is adjusted by this dial.

When stopping PORTAMENTO temporarily, depress the “OFF” button.

c) VCF (Voltage Controlled Filter)

The VCF of the SH-3 controls Cut-off Frequency and Resonance.

As shown in Figure 5, the Cut-off Frequency control has the function of cutting off the high frequency part of the harmonics and plays an important role in tone production.

Note that over-cutting of the harmonics will cause elimination of the basic frequency, and the sound will not be produced. The Resonance control emphasizes the harmonics, producing a peak slightly under the Cut-off Frequency.

Since over-emphasizing the peak causes oscillation of the other frequency for the key depressed, it becomes an interruption in the performance of melody except where special

effect is desired.

Fig. 4

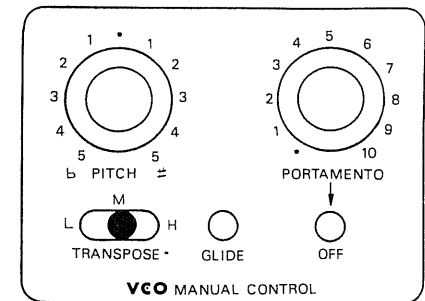
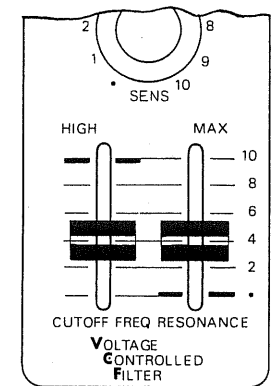

Fig. 5



VCA

o ENVELOPE

By setting the ENVELOPE switch to ADSR, the envelope voltage produced by slide volume knobs of ADSR is supplied to the VCF to create very interesting effects.

By setting the switch to \curvearrowright , the slow attack voltage is supplied to the VCF. And by setting to \frown , an effect similar to WOW can be obtained.

All the envelope voltages are supplied to the VCF via the SENS dial, thus ENVELOPE is inoperative when the SENS dial is in "O" position.

o GROWL

Sliding the GROWL knob creates a kind of phase modulation, and the VIBRATO effect is obtained. This VIBRATO effect differs from the VIBRATO effect added to the VCO on nuance. The modulation speed is controlled via the RATE volume knob of the LFO.

d) VCA (Voltage Controlled Amplifier)

o ENVELOPE

ADSR: When switched to ADSR, envelope voltage produced by ADSR slide knobs is supplied to the VCA, thus volume can be changed via ADSR curves.

SLOW ATTACK:

Switching to \curvearrowright brings a slow rising sound such as produced by a violin or an accordion.

STACCATO:

Switching to \frown causes a Staccato-like sound (like the sound of PIZZICATO playing of a violin) regardless of key depression time. Percussive effect can be obtained via the HOLD dial.

SUSTAIN: \sqcap An effect the same as SUSTAIN alone in ADSR can

be obtained by switching to \sqcap , i.e., a sound is produced as soon as the key is depressed and suddenly stops by releasing the key.

o HOLD

The HOLD is a note memory device, and the note for the key depressed is continued until next key is depressed even though the key is released.

o TREMOLO

The TREMOLO works to supply Tremolo effect to the sound. When employing sine wave (\sim) it is of the usual Tremolo, and for saw-tooth wave (M) it produces an effect like the Tremolo playing of a Mandolin, and use of symmetric rectangular wave (\sqcap) produces a continual sound.

These waves all operate the VCA.

The speed of this Tremolo effect is adjusted by the knob of the LFO.

○ **OUT LEVEL**

This knob controls instrument volume.

e) **LFO-1**

(Low Frequency Oscillator-1)

This oscillates saw-tooth wave to modulate the VCA and other circuits. Speed can be changed via the RATE knob.

f) **LFO-2**

(Low Frequency Oscillator-2)

This oscillates rectangular and sine waves and speed can be changed via the RATE knob. Sliding the DELAY TIME knob produces the delay effect when a key is depressed for the preset frequency by the RATE knob.

g) **NOISE GENERATOR**

The SH-3 comprises a Noise Generator.

Noises are classified into two kinds of noises which are alternated via the Noise Changer. They are the white noise audible as "Shyaa" and the pink noise audible as "Zaa".

As these noises emerge when depressing the key, they may be used together with the sound coming from the VCO.

The sound of a steam locomotive "SL" and the sound of the wind or waves can also be produced by using these noises alone.

When switched to "TO VCF", noise mode can be changed via the VCF, and when switched to "TO VCA", white or pink noise can be directly produced at VCA.

Output can be adjusted by setting the LEVEL dial.

SAMPLER

4. Operation

5. Tuning

h) SAMPLER

The Sampler incorporating a different LFO taps at regular intervals the input voltage produced by the LFO and supplies it to the VCO to produce a series of sounds differing from the sounds made by depressing keys.

When the MODE is switched to RANDOM, the voltage from the Noise Generator produces random sounds. Mode wave forms can be controlled via the Level knob. Thus, via Mode switch, RATE of LFO, LEVEL and SAMPLE TIME controls, many sound variations can be produced.

i) PHONES LEVEL

The PHONES LEVEL control is used for adjusting the volume of the headphones.

1) Connect the output jack to the input jack of the amplifier with the connection cord accessory.

2) Turn the power switches of SH-3 and the amplifier to "ON".

3) Raise the volume of amplifier properly. Setting is thus complete.

Adjustment of the sound volume is to be done via the volume knob.

Allow 5 minutes after setting the power switch to ON, then set the Pitch Knob to "O" position. Tune the Synthesizer to a standard musical instrument by adjusting the TUNING screw located on the left end of the rear panel.

In this case, ascertain that the TRANPOSE is positioned at "M".

(NOTE) In case a sudden temperature variation occurs or the Synthesizer is played over an excessively long time, readjustment of tuning may be required.

6. Accessories (optional)

○ Volume Control Pedal FV-1

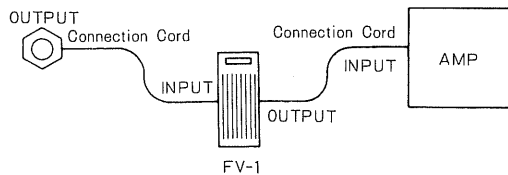

- a) Provides the same effect as obtained by moving the OUT LEVEL knob (volume adjustment). in the VCA segment.
- b) Provides the same effect as obtained by controlling VCF Cut-Off Frequency via slide volume.

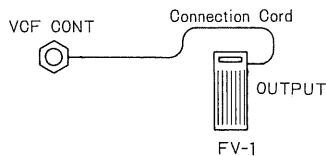

- c) With use the pedal, Glide-Effect can be varied.

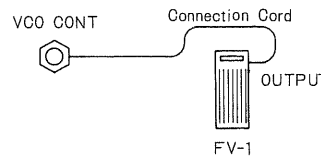

*

Experiment with unique sounds at will. Some examples are shown in attached sheets. keep a record of your favorite sound control.

ROLAND SYNTHESIZER SH-3 SPECIFICATIONS



44 Keys (F scale)	
Note can be raised or lowered by one octave via Transpose switch.	
VCO Assembly (Voltage Controlled Oscillator)	
5 Octave Combination (32', 16', 8', 4', 2')	5
Waveform Selector	5
Moduration Waveform Selector (M/Π/Λ)	1
Moduration Depth Control (VIBRATO)	1
Pitch Control	1
Glide Switch	1
Portamento Time (PORTAMENTO)	1
Portamento OFF Switch (OFF)	1
Transpose Changeover Switch (L/M/H)	1
8' Chorus Speed Control/OFF (8' CHORUS)	1
Sampler	
Sampled Waveform Selector (MODE — OFF/M/M/M/RANDOM)	1
Sampling Time (SAMPLE TIME)	1
Sampling Level Control (LEVEL)	1
VCF Assembly (Voltage Controlled Filter)	
Filter Resonance Control	
CUTOFF FREQ.	1
RESONANCE	1
Moduration Waveform Selector (M/Π/Λ)	1
Moduration Depth Control (GROWL)	1
Envelope Selector (ADSR/Λ/Λ)	1
Envelope Sensitivity Control (SENS)	1
VCA Assembly (Voltage Control Amplifier)	
Moduration Waveform Selector (M/Π/Λ)	1
Moduration Depth Control (TREMOLO)	1
Envelope Selector (ADSR/Λ/Λ/Π)	1
Hold Control	1
OUTPUT Level Control (OUT LEVEL)	1

Others	
Envelope Control	4
Attach Time/Decay Time/Sustain Level/Release Time	
Low Frequency Oscillator 1 Rate	1
Low Frequency Oscillator 2 Rate	1
Low Frequency Oscillator 2 Delay Time Control	1
Noise Generator Level Control	1
White/Pink Noise Changer	1
Noise Input Selector	1
Phones Level Control	1
Tuning (on rear Panel)	1
OUTPUT Jack	1
OUTPUT VOLTAGE CHANGEOVER SWITCH (L/M/H)	1
PHONES Jack	1
Jack for VCO CONTROL	1
Jack for VCF CONTROL	1
Voltage Changer (for changing AC voltage)	1
Power Source	AC 100, 117, 220, 250V 50/60Hz
Power Consumption	8VA
Dimensions	W; 1005mm (40.2") D; 320mm (12.8") H; 150mm (6.0")
Weight (Net)	14.5 Kg (32 Lbs.)
Accessories	Music Rack Connection Cord (2.5m with Pin-Plug Adaptor)
*Accessories (optional)	Volume Control Pedal FV-1 (for controlling Sound Volume, VCO GLIDE effect or VCF CUTOFF-FREQUENCY)

*Specifications subject to change without notice.

Roland®

11467

UPC

11467



10991

Roland®

Free Manuals Download Website

<http://myh66.com>

<http://usermanuals.us>

<http://www.somanuals.com>

<http://www.4manuals.cc>

<http://www.manual-lib.com>

<http://www.404manual.com>

<http://www.luxmanual.com>

<http://aubethermostatmanual.com>

Golf course search by state

<http://golfingnear.com>

Email search by domain

<http://emailbydomain.com>

Auto manuals search

<http://auto.somanuals.com>

TV manuals search

<http://tv.somanuals.com>