

FC-300

MIDI FOOT CONTROLLER

Owner's Manual

Before using this unit, carefully read the sections entitled: "USING THE UNIT SAFELY" (p. 2) and "IMPORTANT NOTES" (p. 4). These sections provide important information concerning the proper operation of the unit. Additionally, in order to feel assured that you have gained a good grasp of every feature provided by your new unit, Owner's Manual should be read in its entirety. The manual should be saved and kept on hand as a convenient reference.

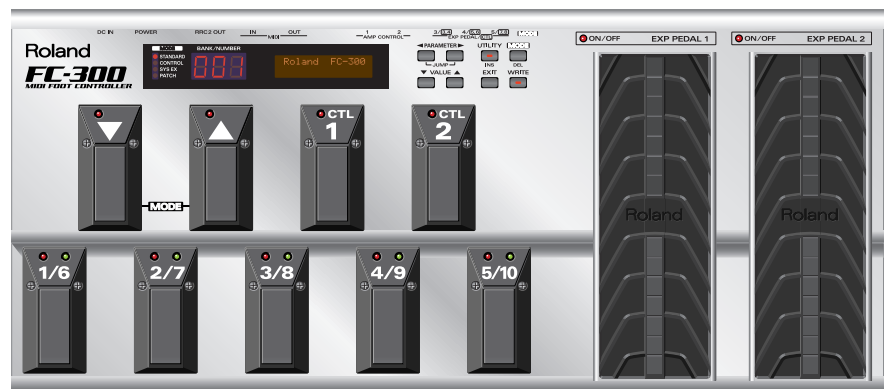

Copyright © 2007 ROLAND CORPORATION

All rights reserved. No part of this publication may be reproduced in any form without the written permission of ROLAND CORPORATION.

USING THE UNIT SAFELY

INSTRUCTIONS FOR THE PREVENTION OF FIRE, ELECTRIC SHOCK, OR INJURY TO PERSONS

About ⚠ WARNING and ⚠ CAUTION Notices

⚠ WARNING	Used for instructions intended to alert the user to the risk of death or severe injury should the unit be used improperly.
⚠ CAUTION	Used for instructions intended to alert the user to the risk of injury or material damage should the unit be used improperly. * Material damage refers to damage or other adverse effects caused with respect to the home and all its furnishings, as well to domestic animals or pets.

About the Symbols

	The ⚠ symbol alerts the user to important instructions or warnings. The specific meaning of the symbol is determined by the design contained within the triangle. In the case of the symbol at left, it is used for general cautions, warnings, or alerts to danger.
	The ⓧ symbol alerts the user to items that must never be carried out (are forbidden). The specific thing that must not be done is indicated by the design contained within the circle. In the case of the symbol at left, it means that the unit must never be disassembled.
	The ⚡ symbol alerts the user to things that must be carried out. The specific thing that must be done is indicated by the design contained within the circle. In the case of the symbol at left, it means that the power-cord plug must be unplugged from the outlet.

ALWAYS OBSERVE THE FOLLOWING

⚠ WARNING

- Before using this unit, make sure to read the instructions below, and the Owner's Manual.
- Do not open (or modify in any way) the unit or its AC adaptor.
- Do not attempt to repair the unit, or replace parts within it (except when this manual provides specific instructions directing you to do so). Refer all servicing to your retailer, the nearest Roland Service Center, or an authorized Roland distributor, as listed on the "Information" page.
- Never use or store the unit in places that are:
 - Subject to temperature extremes (e.g., direct sunlight in an enclosed vehicle, near a heating duct, on top of heat-generating equipment); or are
 - Damp (e.g., baths, washrooms, on wet floors); or are
 - Humid; or are
 - Exposed to rain; or are
 - Dusty; or are
 - Subject to high levels of vibration.
- Make sure you always have the unit placed so it is level and sure to remain stable. Never place it on stands that could wobble, or on inclined surfaces.

⚠ WARNING

- Use only the specified AC adaptor (PSA series), and make sure the line voltage at the installation matches the input voltage specified on the AC adaptor's body. Other AC adaptors may use a different polarity, or be designed for a different voltage, so their use could result in damage, malfunction, or electric shock.
- Do not excessively twist or bend the power cord, nor place heavy objects on it. Doing so can damage the cord, producing severed elements and short circuits. Damaged cords are fire and shock hazards!
- Do not allow any objects (e.g., flammable material, coins, pins); or liquids of any kind (water, soft drinks, etc.) to penetrate the unit.
- In households with small children, an adult should provide supervision until the child is capable of following all the rules essential for the safe operation of the unit.
- Protect the unit from strong impact. (Do not drop it!)
- Before using the unit in a foreign country, consult with your retailer, the nearest Roland Service Center, or an authorized Roland distributor, as listed on the "Information" page.

⚠ WARNING

- Immediately turn the power off, remove the AC adaptor from the outlet, and request servicing by your retailer, the nearest Roland Service Center, or an authorized Roland distributor, as listed on the "Information" page when:
 - The AC adaptor or the power-supply cord has been damaged; or
 - If smoke or unusual odor occurs
 - Objects have fallen into, or liquid has been spilled onto the unit; or
 - The unit has been exposed to rain (or otherwise has become wet); or
 - The unit does not appear to operate normally or exhibits a marked change in performance.
- Do not force the unit's power-supply cord to share an outlet with an unreasonable number of other devices. Be especially careful when using extension cords—the total power used by all devices you have connected to the extension cord's outlet must never exceed the power rating (watts/amperes) for the extension cord. Excessive loads can cause the insulation on the cord to heat up and eventually melt through.
- Batteries must never be recharged, heated, taken apart, or thrown into fire or water.

⚠ CAUTION

- The unit and the AC adaptor should be located so their location or position does not interfere with their proper ventilation. 

- Always grasp only the output plug or the body of the AC adaptor when plugging into, or unplugging from, this unit or an outlet. 

- At regular intervals, you should unplug the AC adaptor and clean it by using a dry cloth to wipe all dust and other accumulations away from its prongs. Also, disconnect the power plug from the power outlet whenever the unit is to remain unused for an extended period of time. Any accumulation of dust between the power plug and the power outlet can result in poor insulation and lead to fire. 

- Try to prevent cords and cables from becoming entangled. Also, all cords and cables should be placed so they are out of the reach of children. 

- Never climb on top of, nor place heavy objects on the unit. 

⚠ CAUTION

- Never handle the AC adaptor body, or its output plugs, with wet hands when plugging into, or unplugging from, an outlet or this unit. 



- Before moving the unit, disconnect the AC adaptor and all cords coming from external devices. 

- Before cleaning the unit, turn off the power and unplug the AC adaptor from the outlet (p. 13). 

- Whenever you suspect the possibility of lightning in your area, disconnect the AC adaptor from the outlet. 

- Used batteries must be disposed of in compliance with whatever regulations for their safe disposal that may be observed in the region in which you live. 

⚠ CAUTION

- If used improperly, batteries may explode or leak and cause damage or injury. In the interest of safety, please read and observe the following precautions (p. 11). 

- Carefully follow the installation instructions for batteries, and make sure you observe the correct polarity. 

- Avoid using new batteries together with used ones. In addition, avoid mixing different types of batteries.

- Remove the batteries whenever the unit is to remain unused for an extended period of time.

- If a battery has leaked, use a soft piece of cloth or paper towel to wipe all remnants of the discharge from the battery compartment. Then install new batteries. To avoid inflammation of the skin, make sure that none of the battery discharge gets onto your hands or skin. Exercise the utmost caution so that none of the discharge gets near your eyes. Immediately rinse the affected area with running water if any of the discharge has entered the eyes.

- Never keep batteries together with metallic objects such as ballpoint pens, necklaces, hairpins, etc.

For EU Countries

UK This symbol indicates that in EU countries, this product must be collected separately from household waste, as defined in each region. Products bearing this symbol must not be discarded together with household waste.

DE Dieses Symbol bedeutet, dass dieses Produkt in EU-Ländern getrennt vom Hausmüll gesammelt werden muss gemäß den regionalen Bestimmungen. Mit diesem Symbol gekennzeichnete Produkte dürfen nicht zusammen mit dem Hausmüll entsorgt werden.

FR Ce symbole indique que dans les pays de l'Union européenne, ce produit doit être collecté séparément des ordures ménagères selon les directives en vigueur dans chacun de ces pays. Les produits portant ce symbole ne doivent pas être mis au rebut avec les ordures ménagères.

IT Questo simbolo indica che nei paesi della Comunità europea questo prodotto deve essere smaltito separatamente dai normali rifiuti domestici, secondo la legislazione in vigore in ciascun paese. I prodotti che riportano questo simbolo non devono essere smaltiti insieme ai rifiuti domestici. Ai sensi dell'art. 13 del D.Lgs. 25 luglio 2005 n. 151.

ES Este símbolo indica que en los países de la Unión Europea este producto debe recogerse aparte de los residuos domésticos, tal como está regulado en cada zona. Los productos con este símbolo no se deben depositar con los residuos domésticos.

PT Este símbolo indica que nos países da UE, a recolha deste produto deverá ser feita separadamente do lixo doméstico, de acordo com os regulamentos de cada região. Os produtos que apresentem este símbolo não deverão ser eliminados juntamente com o lixo doméstico.

NL Dit symbool geeft aan dat in landen van de EU dit product gescheiden van huishoudelijk afval moet worden aangeboden, zoals bepaald per gemeente of regio. Producten die van dit symbool zijn voorzien, mogen niet samen met huishoudelijk afval worden verwijderd.

DK Dette symbol angiver, at i EU-lande skal dette produkt opsamlles adskilt fra husholdningsaffald, som defineret i hver enkelt region. Produkter med dette symbol må ikke smides ud sammen med husholdningsaffald.

NO Dette symbolet indikerer at produktet må behandles som spesialavfall i EU-land, iht. til retningslinjer for den enkelte regionen, og ikke kastes sammen med vanlig husholdningsavfall. Produkter som er merket med dette symbolet, må ikke kastes sammen med vanlig husholdningsavfall.

SE Symbolen anger att i EU-länder måste den här produkten kasseras separat från hushållsavfall, i enlighet med varje regions bestämmelser. Produkter med den här symbolen får inte kasseras tillsammans med hushållsavfall.

FI Tämä merkintä ilmaisee, että tuote on EU-maissa kerättävä erillään kotitalousjätteistä kunkin alueen voimassa olevien määräysten mukaisesti. Tällä merkinnällä varustettuja tuotteita ei saa hävittää kotitalousjätteiden mukana.

HU Ez a szimbólum azt jelenti, hogy az Európai Unióban ezt a terméket a háztartási hulladéktól elkülönítve, az adott régióban érvényes szabályozás szerint kell gyűjteni. Az ezzel a szimbóllal ellátott termékeket nem szabad a háztartási hulladék közé dobni.

PL Symbol oznacza, że zgodnie z regulacjami w odpowiednim regionie, w krajach UE produktu nie należy wyrzucać z odpadami domowymi. Produktów opatrzonych tym symbolem nie można utylizować razem z odpadami domowymi.

CZ Tento symbol udává, že v zemích EU musí být tento výrobek sbírán odděleně od domácího odpadu, jak je určeno pro každý region. Výrobky nesoucí tento symbol se nesmí vyhazovat spolu s domácím odpadem.

SK Tento symbol vyjadruje, že v krajinách EÚ sa musí zber tohto produktu vykonávať oddelene od domového odpadu, podľa nariadení platných v konkrétnej krajine. Produkty s týmto symbolom sa nesmú vyhazovať spolu s domovým odpadom.

EE See sümbol näitab, et EL-i maades tuleb see toode olemprügist eraldi koguda, nii nagu on igas piirkonnas määratletud. Selle sümboliga märgitud tooteid ei tohi ära visata koos olmeprügiga.

LT Šis simbolis rodo, kad ES šalyse šis produktas turi būti surenkamas atskirai nuo buitinių atliekų, kaip nustatyta kiekviename regione. Šiuo simboliu paženklinoti produktai neturi būti išmetami kartu su buitiniomis atliekomis.

LV Šis simbols norāda, ka ES valstīs šo produktu jāievāc atsevišķi no mājsaimniecības atkritumiem, kā noteikts katrā reģionā. Produktus ar šo simbolu nedrīkst izmest kopā ar mājsaimniecības atkritumiem.

SI Ta simbol označuje, da je treba proizvod v državah EU zbirati ločeno od gospodinskih odpadkov, tako kot je določeno v vsaki regiji. Proizvoda s tem znakom ni dovoljeno odlagati skupaj z gospodinskimi odpadki.

GR Бхфр фп уэмвлл дзлоней ъфн уфйт чосет фэт ЕЕ, фп рстѣн бхфр рсЭрей нб ухллЭгехфбн оечсйуфь брь фб пкйкбкь брпсЯммбфб, уэмщнб не фз ннмиеуЯб фэт кьне респнчют. Фб рстѣнбфр рпх цЭлпн бхфр фп уэмвлл ден рсЭрей нб брпсЯрфпфбн бмбЯя не фб пкйкбкь брпсЯммбфб.

IMPORTANT NOTES

In addition to the items listed under "USING THE UNIT SAFELY" on page 2, please read and observe the following:

Power Supply: Use of Batteries

- Do not connect this unit to same electrical outlet that is being used by an electrical appliance that is controlled by an inverter (such as a refrigerator, washing machine, microwave oven, or air conditioner), or that contains a motor. Depending on the way in which the electrical appliance is used, power supply noise may cause this unit to malfunction or may produce audible noise. If it is not practical to use a separate electrical outlet, connect a power supply noise filter between this unit and the electrical outlet.
- The AC adaptor will begin to generate heat after long hours of consecutive use. This is normal, and is not a cause for concern.
- The use of an AC adaptor is recommended as the unit's power consumption is relatively high.
- When installing or replacing batteries, always turn off the power on this unit and disconnect any other devices you may have connected. This way, you can prevent malfunction and/or damage to speakers or other devices.
- Batteries are supplied with the unit. The life of these batteries may be limited, however, since their primary purpose was to enable testing.
- Before connecting this unit to other devices, turn off the power to all units. This will help prevent malfunctions and/or damage to speakers or other devices.

Placement

- This device may interfere with radio and television reception. Do not use this device in the vicinity of such receivers.
- Do not expose the unit to direct sunlight, place it near devices that radiate heat, leave it inside an enclosed vehicle, or otherwise subject it to temperature extremes. Excessive heat can deform or discolor the unit.
- When moved from one location to another where the temperature and/or humidity is very different, water droplets (condensation) may form inside the unit. Damage or malfunction may result if you attempt to use the unit in this condition. Therefore, before using the unit, you must allow it to stand for several hours, until the condensation has completely evaporated.
- Depending on the material and temperature of the surface on which you place the unit, its rubber feet may discolor or mar the surface.

Maintenance

- For everyday cleaning wipe the unit with a soft, dry cloth or one that has been slightly dampened with water. To remove stubborn dirt, use a cloth impregnated with a mild, non-abrasive detergent. Afterwards, be sure to wipe the unit thoroughly with a soft, dry cloth.
- Never use benzine, thinners, alcohol or solvents of any kind, to avoid the possibility of discoloration and/or deformation.

Repairs and Data

- Please be aware that all data contained in the unit's memory may be lost when the unit is sent for repairs. Important data should always be backed up in another MIDI device (e.g., a sequencer), or written down on paper (when possible). During repairs, due care is taken to avoid the loss of data. However, in certain cases (such as when circuitry related to memory itself is out of order), we regret that it may not be possible to restore the data, and Roland assumes no liability concerning such loss of data.

Additional Precautions

- Please be aware that the contents of memory can be irretrievably lost as a result of a malfunction, or the improper operation of the unit. To protect yourself against the risk of losing important data, we recommend that you periodically save a backup copy of important data you have stored in the unit's memory in another MIDI device (e.g., a sequencer).
- Unfortunately, it may be impossible to restore the contents of data that was stored in another MIDI device (e.g., a sequencer) once it has been lost. Roland Corporation assumes no liability concerning such loss of data.
- Use a reasonable amount of care when using the unit's buttons, sliders, or other controls; and when using its jacks and connectors. Rough handling can lead to malfunctions.
- Never strike or apply strong pressure to the display.
- When connecting / disconnecting all cables, grasp the connector itself—never pull on the cable. This way you will avoid causing shorts, or damage to the cable's internal elements.
- To avoid disturbing your neighbors, try to keep the unit's volume at reasonable levels (especially when it is late at night).
- Since sound vibrations can be transmitted through floors and walls to a greater degree than expected, take care not to allow such sound to become a nuisance to neighbors, especially at night and when using headphones.
- When you need to transport the unit, package it in the box (including padding) that it came in, if possible. Otherwise, you will need to use equivalent packaging materials.
- Use only the specified expression pedal (Roland EV-5, BOSS FV-500L or FV-500H; sold separately). By connecting any other expression pedals, you risk causing malfunction and/or damage to the unit.

Table of Contents

Introduction	7
Main Features.....	7
Panel Descriptions.....	7
Display	7
Top Panel (Buttons)	8
Top Panel (Pedals)	9
Rear Panel.....	10
Making the Connections.....	11
Connections To Make When Using the FC-300 as a MIDI Foot Controller.....	11
Connections To Make When Using the FC-300 as a Dedicated Foot Controller for an RRC2 IN Device (e.g., the VG-99).....	12
Turning the Power On and Off	13
When Using the FC-300 as a MIDI Foot Controller	13
When Using the FC-300 as a Dedicated Foot Controller for an RRC2 IN Device (e.g., the VG-99).....	13
About the MODES.....	14
Standard Mode (p. 16)	14
Control Change Mode (p. 21)	14
System Exclusive Mode (p. 28).....	14
Patch Mode (p. 29)	14
Switching Modes	15
About the Mode Indicators.....	15
Standard Mode	16
Transmitting Program Change Messages.....	16
Setting How Tones are Switched	16
Transmitting Control Change Messages.....	17
Using the Expression Pedals	17
Using the Control Pedal and Expression Pedal Switch.....	17
Using the External Control Pedals and Expression Pedals.....	18
Controller Numbers for Each Pedal	18
Change the Pedal Settings.....	19
Control Change Mode.....	21
About the Control Change Mode.....	21
Transmitting Control Change Messages.....	21
Number Pedal (1/6-5/10)	21
[▼] [▲] Pedal	21
Using the Expression Pedals	22
Using the Control Pedal and Expression Pedal Switch.....	22
Using Additional Footswitches and Expression Pedals.....	23
Controller Numbers of the Pedals	23
Change the Pedal Settings.....	24
Storing Controller Numbers Assigned to the Pedals (Pedal Settings)	26
Switching Control Numbers Assigned to the Pedals Simultaneously	26
Deleting a Pedal Setting.....	27
System Exclusive Mode	28
Patch Mode.....	29
About the Patch Mode	29
About the Patch	29
Transmitting Control Change Messages.....	30
Using the Expression Pedals	30
Using the Control Pedals and Expression Pedal Switches.....	30
Using the External Control Pedals and Expression Pedals.....	31
The Controller Number of Each Pedal.....	31
Transmitting Patch Data.....	32
Creating Patches	33
Editing MIDI Streams.....	34

How to Copy MIDI Streams	39
How to Delete MIDI Streams	40
Setting the Timing for Transmission of OFF MIDI Streams	40
Setting the Amp Control	41
Change the Pedal Settings.....	42
Set the Patch Name	44
Storing (Saving) Patches.....	44
Deleting Patches	45
Other Features	46
Setting the System Parameters	46
Adjusting the LCD Contrast.....	46
Reducing Battery Consumption (Economy Mode).....	46
Setting the Method Used for Transmitting Program Change messages in Standard Mode (PC Mode)	47
Using the [▼] [▲] Pedals to Make the Settings	48
Limiting the Range of Banks That Can Be Switched (Bank Extent)	48
Setting the [▼] [▲] Pedal Step Size	49
Setting How Numbers are Indicated.....	49
Setting the Polarity of the AMP CONTROL Jacks	50
Determining the Role of an EXP PEDAL/CTL Jack	50
Switching the Function of the MODE Pedal Jack.....	51
Switching How the Pedal Indicators Light	51
Setting the MIDI Transmit Channel	52
Setting the Device ID	52
Setting the Bank Select Output.....	52
Setting the Bank Select Value	53
Transmitting Data to an External MIDI Device (Bulk Dump)	53
Receiving Data from an External MIDI Device (Bulk Load)	54
Appendices.....	55
Restoring the Factory Settings (Factory Reset).....	55
Adjusting the Expression Pedal	56
Error Messages.....	57
Battery Low!.....	57
Memory Full!	57
MIDI Buffer Full!.....	57
MIDI Offline!.....	57
RRC2 Buffer Full!	57
RRC2 Offline!	57
Troubleshooting.....	58
MIDI Implementation.....	59
Roland System Exclusive Messages.....	59
1. Data Format for Exclusive Messages	59
2. Address-mapped Data Transfer	59
3. One-way Transfer Procedure	60
1. Recognized Receive Data	62
2. Transmitted Data.....	62
Transmitted Messages	62
3. Exclusive Communications.....	64
4. Parameter Address Map (Model ID = 00H 00H 20H).....	64
Specifications.....	68
FC-300 : MIDI FOOT CONTROLLER	68
Index.....	69

Introduction

Main Features

- Features four modes (Standard Mode, Control Change Mode, System Exclusive Mode, Patch Mode)
- Unit comes equipped with two expression pedals and two control pedals. You can also expand control even further with up to three external expression pedals or six external control pedals.
- Includes 16-character x 2-line LCD
- Equipped with RRC2 OUT connector; enables connection with RRC2 IN compatible devices with a single cable
- Includes two separate amp control channels
- Features three-way power supply (AC Adaptor, Dry battery, RRC2)

Panel Descriptions

Display

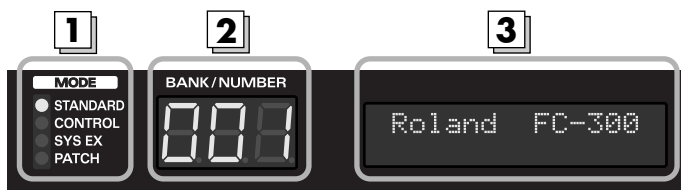

1 **MODE indicator**

The current mode is indicated here. (p. 15)

2 **BANK/NUMBER display**

The currently selected bank and number are indicated here.

3 **Liquid Crystal display (LCD)**

A variety of information is shown in this display.

Top Panel (Buttons)

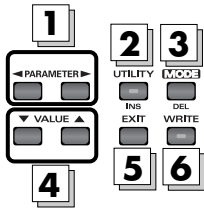

1 **PARAMETER button [◀] [▶]**

Press these to select parameters.

2 **UTILITY button / INS (insert) button**

Press this when changing system settings. In the Edit screen, this is used to insert MIDI messages and blank spaces.

3 **MODE button / DEL (delete) button**

Press this to change the FC-300's operating mode. In the Edit screen, this is used to delete a MIDI message or a character at the cursor location.

4 **VALUE button [▼] [▲]**

Use this when changing the values of settings.

5 **EXIT button**

Press this to undo an operation and return to the previous screen.

6 **WRITE button**

Press this to store settings and execute procedures.

MEMO

To jump to the main parameters, hold down one of these buttons while you press the other. With items for which there aren't that many parameters, the FC-300 jumps to the last (or initial) parameter.

MEMO

- By continuing to hold down VALUE for a number of seconds, the value of the setting can be increased/ decreased continuously.
- The value will increase rapidly if you hold down VALUE [▲], then press and hold VALUE [▼].
- The value will decrease rapidly if you hold down VALUE [▼], then press and hold [▲].

Top Panel (Pedals)

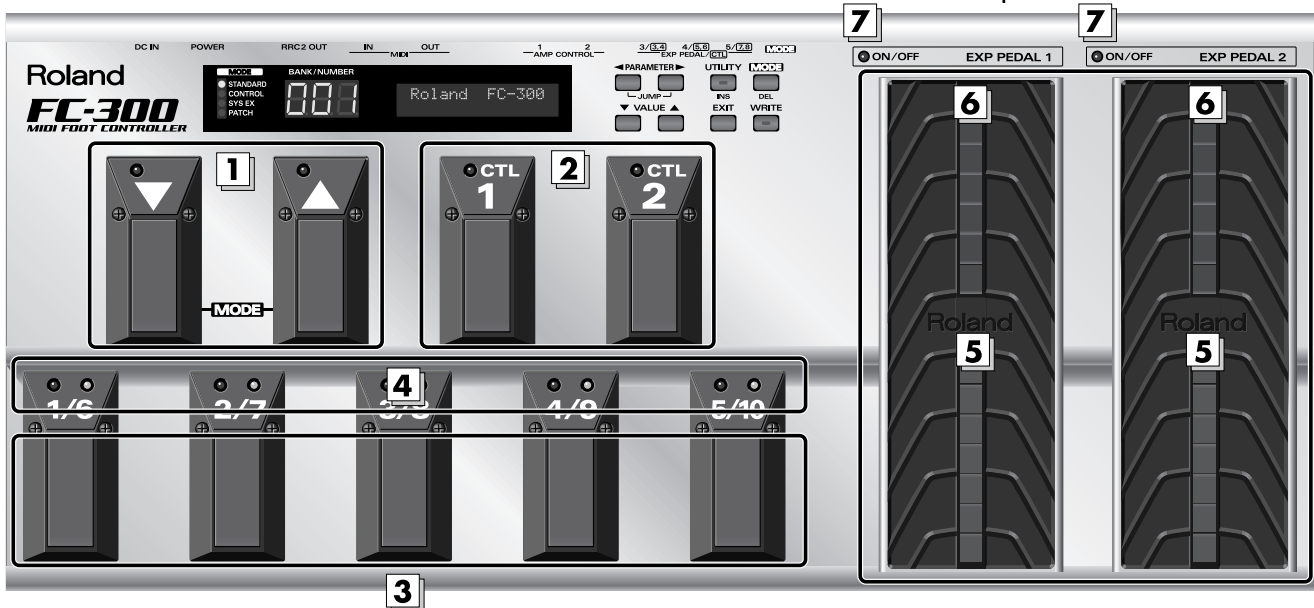

- 1** [▼] [▲] (down / up) pedals
Use these pedals to switch banks and select numbers.
Additionally, you can switch modes by pressing the pedals simultaneously.
- 2** CTL (Control) pedals (1, 2)
You can assign the desired functions to these pedals, then use them for control over those functions.
- 3** Number pedals (1/6 – 5/10)
These switch the patch numbers.
- 4** Number pedal indicators (1/6 – 5/10)
The indicator for the currently selected number lights.
A red indicator lights when a number from 1 through 5 is selected; a green indicator lights when a number from 6 through 10 is selected.
- 5** EXP PEDAL (expression pedal) (1, 2)
These control the volume, wah, or other aspects of connected devices.
- 6** EXP PEDAL SW (expression pedal switch) (1, 2)
Firmly press down at the front of the pedal to switch the effect on and off.
- 7** EXP PEDAL SW indicators (expression pedal switch indicators) (1, 2)
Lights when the effect being controlled with the EXP PEDAL SW is on, and goes out when the effect is turned off.

NOTE

When you operate the expression pedal, please be careful not to get your fingers pinched between the movable part and the panel. In households with small children, an adult should provide supervision until the child is capable of following all the rules essential for the safe operation of the unit.

Rear Panel

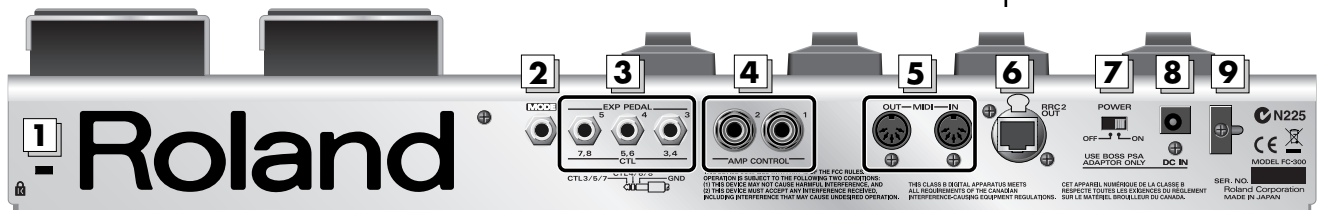

1

Security Slot

<http://www.kensington.com/>

2

MODE jack

Connect an optional footswitch (such as the BOSS FS-5U) here.

The function is the same as that when the [▼] and [▲] pedals are held down simultaneously.

3

EXP PEDAL/CTL jack

Connect an optional expression pedal (such as the Roland EV-5, BOSS FV-500L/FV-500H) or footswitch (such as the BOSS FS-5U/FS-6) here.

4

AMP CONTROL 1, 2 jack

When using the AMP CONTROL function, connect to the jack used for switching guitar amp channels.

5

MIDI connectors (OUT, IN)

Connect an external MIDI device to these connectors to transmit and receive MIDI messages.

6

RRC2 OUT connector

You can connect an external RRC2 IN device here to transmit and receive performance data between the devices.

At the same time, the FC-300 can be powered by the external RRC2 IN device.

7

POWER switch

Turns the power on and off.

8

DC IN (AC Adaptor) jack

Connect the AC adaptor (PSA series; sold separately) here.

9

Cord Hook

Hook the AC adaptor cord here to prevent the adaptor plug from being disconnected. Refer to “Connecting an AC Adaptor” (p. 12).

NOTE

Be sure to connect the RRC2 OUT connector to a device with an RRC2 IN connector. Use of the connection with other devices may cause generation of heat and damage to the equipment.

MEMO

When running on power supplied by an RRC2 IN device, the power is switched on regardless of the position of the POWER switch.

TERM

RRC2 is a Roland standard developed to enable two-way communications between RRC2 IN devices and RRC2 OUT devices, while supplying power to the RRC2 OUT device from the RRC2 IN device, all with a single cable.

NOTE

You must use only the PSA series AC adaptor. Use of any other adaptor may cause overheating or malfunctions.

Making the Connections

When making connections to other equipment, be sure that all equipment is switched off. If you try to make connections while the power is turned on, the settings for the FC-300 may be changed.

Connections To Make When Using the FC-300 as a MIDI Foot Controller

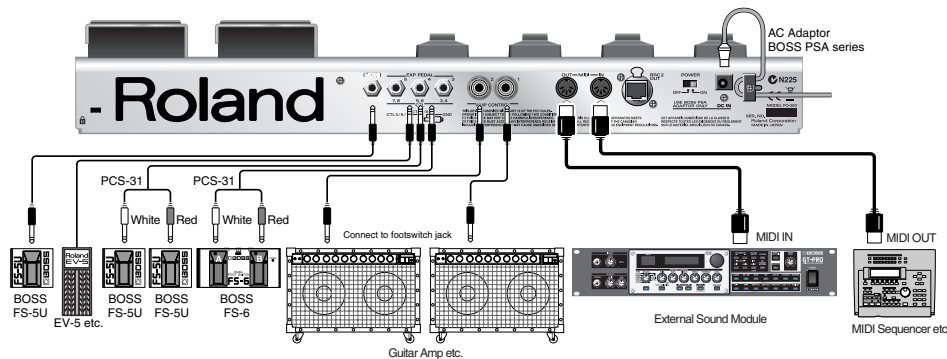

If you want to use a footswitch for changing the mode, be sure to connect a BOSS FS-5U/FS-6 footswitch (Optional) to the MODE jack.

When using the FS-5U or FS-6, set the polarity switch as shown below.

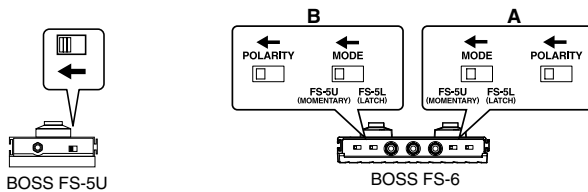

Install batteries

The FC-300 is not loaded with batteries when purchased.

When running the FC-300 on battery power, install the batteries using the following figure.

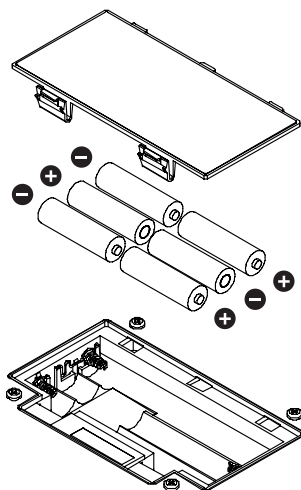

NOTE

Before connecting other devices, always be sure to turn down the volume on all devices and turn off their power to prevent malfunction and damage to the speakers (or other components) of connected devices.

MEMO

This instrument is equipped with 1/4 inch TRS phone type jacks. Wiring diagrams for these jacks are shown below. Make connections after first checking the wiring diagrams of other equipment you intend to connect.



NOTE

- When turning the unit upside-down, get a bunch of newspapers or magazines, and place them under the four corners or at both ends to prevent damage to the buttons and controls. Also, you should try to orient the unit so no buttons or controls get damaged.
- When turning the unit upside-down, handle with care to avoid dropping it, or allowing it to fall or tip over.

MEMO

When the battery power begins to run low, "Battery Low!" appears in the display. When this occurs, replace with new batteries as soon as possible. Pressing [EXIT] clears the message from the display.

Introduction

Connecting an AC Adaptor

If you're using a BOSS PSA series AC adaptor, here's how to connect the cord and secure it on the cord hook.

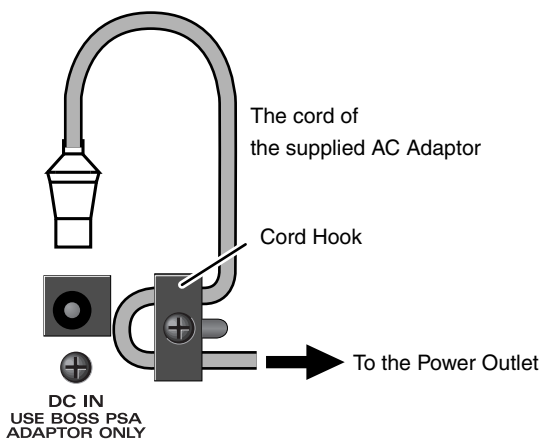

Connections To Make When Using the FC-300 as a Dedicated Foot Controller for an RRC2 IN Device (e.g., the VG-99)

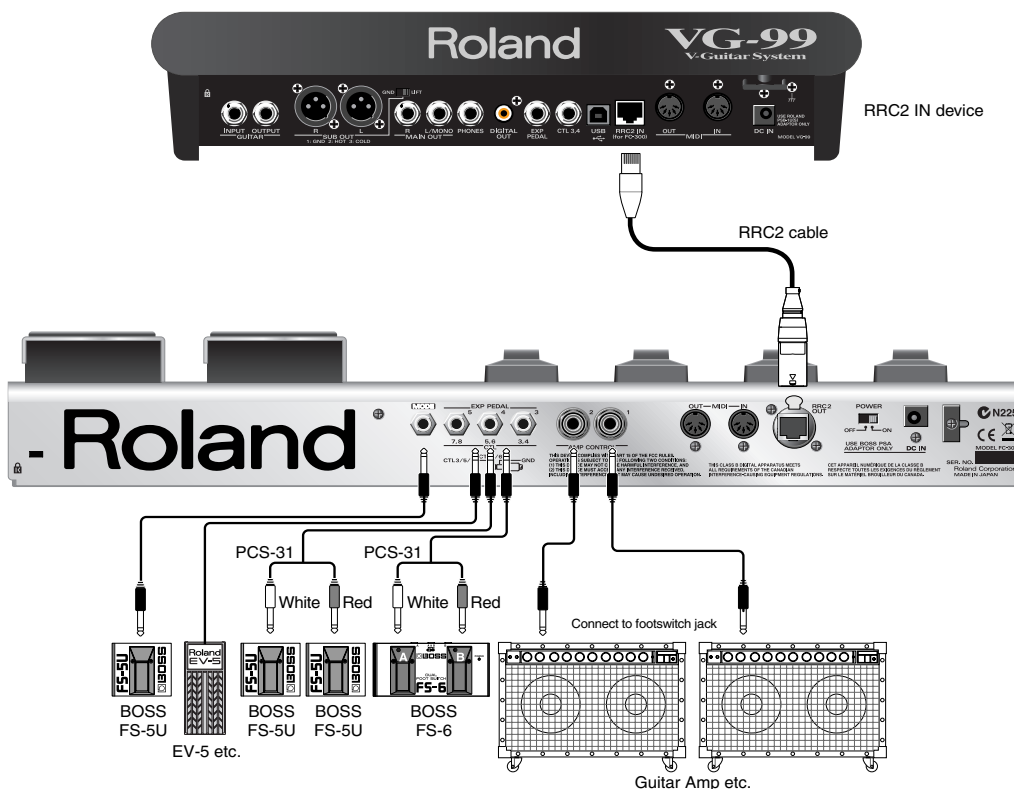

* Power is supplied from the RRC2 IN device, so no batteries or AC adaptor is necessary.

* If using commercially available ethernet cable as the RRC2 connecting cable, be sure that the cable meets the following specifications.

- Category 5 (Cat5) or above
- Maximum length of 15 meters
- Cable designed for straight-through connections

MEMO

Use only the specified expression pedal (Roland EV-5, BOSS FV-500L/FV-500H; each sold separately). By connecting any other expression pedals, you risk causing malfunction and/or damage to the unit.

NOTE

Carefully connect the RRC2 cable or Ether cable all the way in—until it is firmly to the RRC2 connector.

NOTE

Ethernet cables designed for crossover connections cannot be used.

NOTE

Do not subject the RRC2 cable and the Ether cable to stress or physical shock.

Turning the Power On and Off

Once the connections have been completed (p. 11), turn on power to your various devices in the order specified. Turning on devices in the wrong order may cause malfunction or damage to the speakers (or other components) of connected devices.

When Using the FC-300 as a MIDI Foot Controller

Turning On the Power

First, check that you are connected properly with the external MIDI instrument. Then set the power switch on the FC-300 to "ON."



When the power is turned on, the FC-300 starts up in Standard Mode.

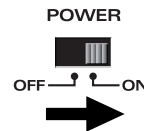

cf.

In addition, it starts up with the MIDI channel set to "1," but you can change the startup MIDI channel if you want. Refer to "**Setting the MIDI Transmit Channel**" (p. 52).

Turning Off the Power

- 1 Switch off the power to the device connected to the FC-300.
- 2 Set the FC-300's POWER switch to OFF.

When Using the FC-300 as a Dedicated Foot Controller for an RRC2 IN Device (e.g., the VG-99)

Turning On the Power

First, check that you are connected properly with the RRC2 IN device. Then set the power switch on the RRC2 IN device to "ON."



Turning Off the Power

Switch off the power to the RRC2 IN device connected to the FC-300.

NOTE

Carefully connect the RRC2 cable or Ether cable all the way in—until it is firmly to the RRC2 connector.

MEMO

When the RRC2 IN device's POWER switch is set to ON, the FC-300's power switches on automatically, regardless of the position of the FC-300's POWER switch.

MEMO

Although the FC-300 starts up in Standard Mode, it may be switched to a different mode by means of settings received from an RRC2 IN device.

About the MODES

The FC-300 features the following four modes. The pedals function differently depending on the mode that's selected.

This manual describes each mode separately, while explaining the items available in a particular mode.



See “**Switching Modes**” (p. 15) for an explanation of how to choose a mode.

Standard Mode (p. 16)

This mode is for sending Program Change messages and Control Change messages. You can use the pedals to send any Program Change messages.

Control Change Mode (p. 21)

This mode is for sending Control Change messages.

You can use this mode to send the Control Change messages assigned to the pedals, and enhance the expressiveness of a performance.

You can also store up to five sets, or configurations, of settings for all of the pedals (Pedal Setting function).

System Exclusive Mode (p. 28)

This mode is for sending System Exclusive messages.

You can use this mode to operate other equipment that accepts SysEx messages sent from the FC-300.

Patch Mode (p. 29)

This mode is for transmitting multiple MIDI messages (MIDI streams) already saved to patches.

Patches are areas of memory in which MIDI streams are stored; you can save up to 100 patches.

An individual patch can hold MIDI messages containing up to a maximum of approximately 500 bytes.

Using Patch Mode, you can transmit groups of MIDI messages through one patch, which allows you to switch the settings of multiple devices all at once.

Switching Modes

You can switch modes using one of the following methods.

- Press [MODE]
- Press a footswitch (BOSS FS-5U/FS-6; sold separately) connected to the MODE jack
- Simultaneously press the [▼] and [▲] pedals

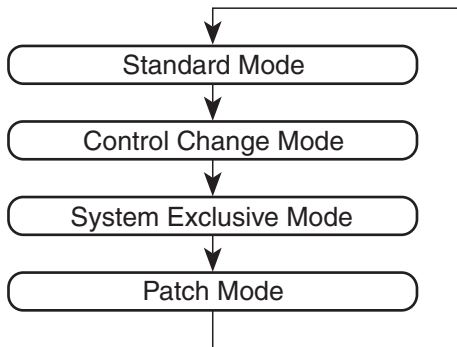

MEMO

The explanations in this manual include illustrations that depict what should typically be shown by the display. Note, however, that your unit may incorporate a newer, enhanced version of the system, so what you actually see in the display may not always match what appears in the manual.

cf.

You can change the way the mode is switched when using [▼] and [▲] pedal or footswitch. See “**Switching the Function of the MODE Pedal Jack**” (p. 51) for the details on how to do this.

About the Mode Indicators

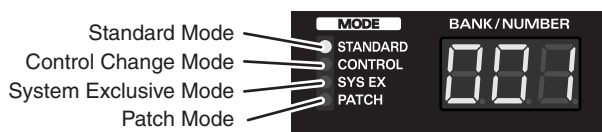

The current mode is indicated with the MODE indicators. You can switch modes only from the top screen of any mode.

Standard Mode

This is the mode for sending Program Change messages and Control Change messages.

Transmitting Program Change Messages

Pressing [▼] and [▲] pedals and the number pedals (1/6 – 5/10) transmits the Program Change messages and Bank select messages for the corresponding number pedals.

1

Press the [▼] pedal, and the numbers decrease by five; press the [▲] pedal, and the numbers increase by five.

The BANK/NUMBER display and Number pedal indicators flash.

2

Press the number pedal (1/6–5/10) to select the number.

The indicator for the number pedal pressed lights, and the Program Change message is transmitted.

With the factory settings, transmission of Bank Select messages and Program Change messages is in accordance with what is indicated in the BANK/NUMBER display, as shown below.

BANK/NUMBER Display	Bank Select Message		Program Change Message
	(MSB)	(LSB)	
001–128	0	0	1–128
129–130	1	0	29–30

cf.

- With the factory settings, Program Change messages are not transmitted just by pressing the [▼] and [▲] pedals. To transmit Program Change messages just by pressing the [▼] and [▲] pedals, read “Using the [▼] [▲] Pedals to Make the Settings” (p. 48).
- You can press the [▼] or [▲] pedal to change patch numbers ten at a time. For more detailed information, see “Setting the [▼] [▲] Pedal Step Size” (p. 49).
- You can limit the range of numbers switched. For more detailed information, see “Limiting the Range of Banks That Can Be Switched (Bank Extent)” (p. 48).
- You can indicate the pedal bank and number separately in the BANK/NUMBER display. For details, refer to “Setting How Numbers are Indicated” (p. 49).
- You can stop output of Bank Select messages. For details, refer to “Setting the Bank Select Output” (p. 52).
- You can change the Bank Select messages. For details, refer to “Setting the Bank Select Value” (p. 53).

Setting How Tones are Switched

You can set the way the FC-300 switches tones with the pedals and displays tone numbers.

Make the settings to match the specifications of the external MIDI devices you are using (p. 47).

Transmitting Control Change Messages

You can transmit Control Change messages with expression pedals and control pedals.

Using the Expression Pedals

In keeping with the movement of the expression pedal, Control Change messages with the controller numbers set for each pedal are transmitted consecutively.

Each pedal is set at the factory as shown below.

Expression Pedal	CC#	Range
EXP PEDAL 1	7	0-127
EXP PEDAL 2	1	0-127

Using the Control Pedal and Expression Pedal Switch

When you use control pedals, you can use the control pedals to send the Control Change messages for the controller numbers assigned to each of the pedals.

In addition, you can activate the expression pedal switch by strongly pressing down on the toe end of the pedal.

Control Change messages with the controller numbers set for each pedal are transmitted.

Each pedal is set at the factory as shown below.

Pedal	CC#	Range	Mode
CTL PEDAL 1	80	0-127	LATCH
CTL PEDAL 2	81	0-127	LATCH
EXP PEDAL SW 1	82	0-127	LATCH
EXP PEDAL SW 2	83	0-127	LATCH

cf. ➔

For details about the all parameters and changes the setting, refer to “**Change the Pedal Settings**” (p. 19).

cf. ➔

The Control pedal is a momentary type pedal that sends an ON message when depressed and an OFF message when released. You can change this to latch type operation, which sends an ON or OFF message each time you depress it – see “**Mode**” (p. 20).

cf. ➔

You can use the control pedal and expression pedal switch to switch the AMP CONTROL jacks – see “**Change the Pedal Settings**” (p. 19).

Using the External Control Pedals and Expression Pedals

You can connect separately available footswitches and expression pedals and use the external pedals just like the FC-300's pedals to transmit Control Change messages, Realtime messages, and other such data.

When a BOSS FS-5U, FS-6 Footswitch is Connected, Assigned to CTL Pedal:

These function in the same way as the FC-300's built-in control pedals.

Connect a control pedal to the EXP PEDAL/CTL jack and set the FC-300 to enable use of the pedal. (p. 50)

- * If you have two FS-5U pedals or an FS-6 pedal connected to the CTL3,4 jack with a special PCS-31 connecting cable (from Roland; available separately), the footswitch connected to the plug with the white ring controls the setting of CONTROL 3, and the footswitch connected to the plug with the red ring controls the setting of CONTROL 4.
- * When only one footswitch is connected to the CTL3,4 jack, the CONTROL 3 settings are enabled.
- * When an FS-6 is connected to the CTL3,4 jack with an optional connection cable (stereo 1/4" phone ↔ stereo 1/4" phone), pedal switch B operates according to the CONTROL 3 settings, and pedal switch A operates according to the CONTROL 4 settings.

When a Roland EV-5, BOSS FV-500L or FV-500H is Connected, Assigned to Expression Pedal:

These function in the same way as the FC-300's built-in expression pedals.

Connect an expression pedal to the EXP PEDAL/CTL jack and set the FC-300 to enable use of the pedal. (p. 50)

- * These do not operate as expression pedal switches.
- * If you are connecting a BOSS FV-500L/FV-500H, connect the pedal with an optional connection cable (stereo 1/4" phone ↔ stereo 1/4" phone).

Controller Numbers for Each Pedal

Each pedal is set at the factory as shown below.

Pedal	CC#	Range	Mode
CTL3	76	0-127	LATCH
CTL4	75	0-127	LATCH
CTL5	10	0-127	LATCH
CTL6	91	0-127	LATCH
CTL7	11	0-127	LATCH
CTL8	64	0-127	LATCH
EXP PEDAL 3	76	0-127	-
EXP PEDAL 4	10	0-127	-
EXP PEDAL 5	11	0-127	-

cf. ➤

For details about the all parameters and changes the setting, refer to “**Change the Pedal Settings**” (p. 19).

cf. ➤

See “**Making the Connections**” (p. 11) for instructions on setting the polarity switch and mode switch for the connected pedal.

cf. ➤

For details about the all parameters and changes the setting, refer to “**Change the Pedal Settings**” (p. 19).

Change the Pedal Settings

You can freely change the settings for each pedal.

1 In the Standard Mode's top screen, press **PARAMETER** [▶].

2 Press **PARAMETER** [◀][▶] to display the pedal setting screens.

```
CTL1:Assign
      CC# 80▶
```

```
CTL1:Range
      0 - 127▶
```

```
CTL8:AMP CTL1 0=
      41:OFF 2:OFF
```

3 Press **VALUE** [▼][▲] to change the value.

MIDI Messages

This selects the MIDI messages to be transmitted.

```
CTL1:Assign
      CC# 80▶
```

MIDI Message

- OFF

These do not output MIDI messages.
- CC#1–CC#31, CC#33–CC#95

These output Control Change messages.

When the pedal is used as an expression pedal, consecutive values are output within the range set with the Range setting. When the pedal is used as a control pedal or other type of switch, the maximum value is output when the switch is on, and the minimum value is output when the switch is off.
- MIDI START / MIDI STOP / MIDI CONTINUE / MMC STOP / MMC PLAY / MMC DEF PLAY / MMC FAST FWD / MMC REWIND / MMC REC STROBE / MMC REC EXIT / MMC REC PAUSE / MMC PAUSE

This transmits MIDI Realtime messages and MMC messages.

When assigned to an expression pedal, messages are output once the pedal is pressed downward past the halfway point; when assigned to a control pedal or other switch, the messages are output when the switch is on.
- P.BEND / CH.PRS

These transmit various Pitch Bend messages and Channel Pressure messages.

When assigned to an expression pedal, consecutive values are output within the range set with the Range parameter. When assigned to a control pedal, the maximum value is output when the switch is on, and the minimum value is output when the switch is off.

Standard Mode

Range

This sets the range for values that are transmitted.

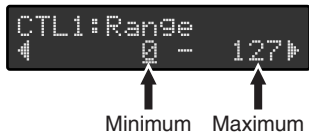

Mode

This sets the switch mode.



Value	Explanation
LATCH	The ON and OFF will alternate each time you press the pedal.
MOMENTARY	The value will be ON while you press the pedal, and OFF when you release the pedal.

AMP Ctl Op (Amp Control Operation)

This selects whether or not the AMP CONTROL jack is to be controlled.

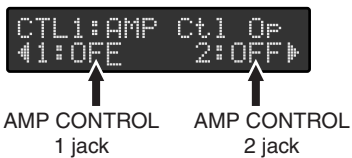

When the AMP Ctl Op parameter is set to ON and the AMP Polarity parameter is set to Normal, control of AMP CONTROL with the pedal functions as shown below.

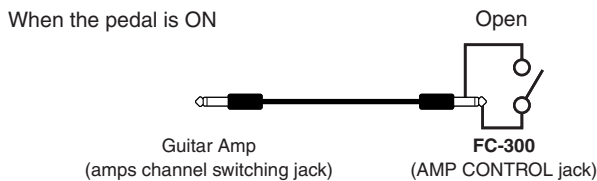
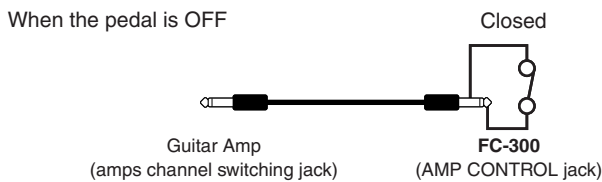

4

When you have finished making the settings, press [EXIT] to return to the initial screen.

The settings are saved, and the FC-300 returns to the initial screen.

MEMO

The Range parameter is enabled when CC#, P.BEND, or CH.PRS is selected.

MEMO

The Mode parameter and AMP Ctl Op parameter are enabled when a control pedal or other switch function is selected. This parameter is ignored when the pedal is used as an expression pedal.

cf.

You can change the polarity of the AMP CONTROL jacks. For more detailed information, see "Setting the Polarity of the AMP CONTROL Jacks" (p. 50).

Control Change Mode

About the Control Change Mode

This is the mode for sending Control Change messages.

In this mode, all the pedals can be used to send Control Change messages. You should use this mode at times when you want to send a lot of Control Change messages.

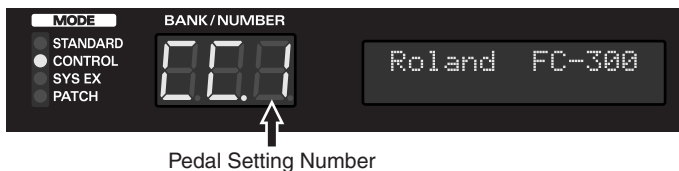

Pedal Setting Number

You can also store up to five sets, or configurations, of settings for all of the pedals within the FC-300's memory. Called pedal settings, these configurations can be switched as needed (p. 26).

Transmitting Control Change Messages

Pressing the various pedals transmits the Control Change messages set for the respective pedal over the selected MIDI channel.

Number Pedal (1/6–5/10)

Control Change messages with the controller numbers set for each pedal are transmitted.

Each pedal is set at the factory as shown below.

Pedal	CC#	Range	Mode	Pedal	CC#	Range	Mode
1	65	0–127	LATCH	6	70	0–127	LATCH
2	66	0–127	LATCH	7	71	0–127	LATCH
3	67	0–127	LATCH	8	72	0–127	LATCH
4	68	0–127	LATCH	9	73	0–127	LATCH
5	69	0–127	LATCH	10	74	0–127	LATCH

cf. ➤

For details about the all parameters and changes the setting, refer to “**Change the Pedal Settings**” (p. 24).

[▼] [▲] Pedal

These switch the number pedal functions.

Pedal	Explanation
[▼]	This sets the number pedals to function as pedals 1–5.
[▲]	This sets the number pedals to function as pedals 6–10.

When the [▼] pedal is pressed, the [▼] pedal's indicator lights, and the functions for number pedals 1–5 become operable.

When the [▲] pedal is pressed, the [▲] pedal's indicator lights, and the functions for number pedals 6–10 become operable.

Using the Expression Pedals

In keeping with the movement of the expression pedal, Control Change messages with the controller numbers set for each pedal are transmitted consecutively.

Each pedal is set at the factory as shown below.

Expression Pedal	CC#	Range
EXP PEDAL 1	7	0-127
EXP PEDAL 2	1	0-127

Using the Control Pedal and Expression Pedal Switch

Control Change messages with the controller numbers set for each pedal are transmitted.

Each pedal is set at the factory as shown below.

Pedal	CC#	Range	Mode
CTL PEDAL 1	80	0-127	LATCH
CTL PEDAL 2	81	0-127	LATCH
EXP PEDAL SW 1	82	0-127	LATCH
EXP PEDAL SW 2	83	0-127	LATCH

cf. ➤

For details about the all parameters and changes the setting, refer to “**Change the Pedal Settings**” (p. 24).

cf. ➤

The Control pedal is a momentary type pedal that sends an ON message when depressed and an OFF message when released. You can change this to latch type operation, which sends an ON or OFF message each time you depress it – see “**Mode**” (p. 25).

cf. ➤

You can use the control pedal and expression pedal switch to switch the AMP CONTROL jacks – see “**Change the Pedal Settings**” (p. 24).

Using Additional Footswitches and Expression Pedals

You can connect separately available footswitches and expression pedals and use the external pedals just like the FC-300's pedals to transmit Control Change messages, Realtime messages, and other such data.

When a BOSS FS-5U, FS-6 Footswitch is Connected, Assigned to CTL Pedal:

These function in the same way as the FC-300's built-in control pedals.

Connect a control pedal to the EXP PEDAL/CTL jack and set the FC-300 to enable use of the pedal. (p. 50)

- * *If you have two FS-5U pedals or an FS-6 pedal connected to the CTL3,4 jack with a special PCS-31 connecting cable (from Roland; available separately), the footswitch connected to the plug with the white ring controls the setting of CONTROL 3, and the footswitch connected to the plug with the red ring controls the setting of CONTROL 4.*
- * *When only one footswitch is connected to the CTL3,4 jack, the CONTROL 3 settings are enabled.*
- * *When an FS-6 is connected to the CTL3,4 jack with an optional connection cable (stereo 1/4" phone ←→ stereo 1/4" phone), pedal switch B operates according to the CONTROL 3 settings, and pedal switch A operates according to the CONTROL 4 settings.*

When a Roland EV-5, BOSS FV-500L or FV-500H is Connected, Assigned to Expression Pedal:

These function in the same way as the FC-300's built-in expression pedals.

Connect an expression pedal to the EXP PEDAL/CTL jack and set the FC-300 to enable use of the pedal. (p. 50)

- * *These do not operate as expression pedal switches.*
- * *If you are connecting a BOSS FV-500L or FV-500H, connect the pedal with an optional connection cable (stereo 1/4" phone ←→ stereo 1/4" phone).*

cf. ➤

For details about the all parameters and changes the setting, refer to "**Change the Pedal Settings**" (p. 24).

cf. ➤

See "**Making the Connections**" (p. 11) for instructions on setting the polarity switch and mode switch for the connected pedal.

Controller Numbers of the Pedals

Each pedal is set at the factory as shown below.

Pedal	CC#	Range	Mode
CTL3	76	0-127	LATCH
CTL4	75	0-127	LATCH
CTL5	10	0-127	LATCH
CTL6	91	0-127	LATCH
CTL7	11	0-127	LATCH
CTL8	64	0-127	LATCH
EXP PEDAL 3	76	0-127	-
EXP PEDAL 4	10	0-127	-
EXP PEDAL 5	11	0-127	-

cf. ➤

For details about the all parameters and changes the setting, refer to "**Change the Pedal Settings**" (p. 24).

Change the Pedal Settings

You can freely change the settings for each pedal.

1 In the Control Change Mode's top screen, press **PARAMETER** [▶].

2 Pressing **PARAMETER** [◀] [▶] to show the pedal setting screens.



```
PDL1:Assign
      CC# 65▶
```



```
PDL1:Range
      0 - 127▶
```



```
CTL8:AMP Ctl 0: OFF
          2: OFE
```

3 Press **VALUE** [▼] [▲] to change the value.

MIDI Messages

This selects the MIDI messages to be transmitted.



```
PDL1:Assign
      CC# 65▶
```

MIDI Message

- OFF
These do not output MIDI messages.
- CC#1–CC#31, CC#33–CC#95
These output Control Change messages.
When assigned to an expression pedal, consecutive values are output within the range set with the Range parameter. When assigned to a control pedal, the maximum value is output when the switch is on, and the minimum value is output when the switch is off.
- MIDI START / MIDI STOP / MIDI CONTINUE / MMC STOP / MMC PLAY / MMC DEF PLAY / MMC FAST FWD / MMC REWIND / MMC REC STROBE / MMC REC EXIT / MMC REC PAUSE / MMC PAUSE
This transmits MIDI Realtime messages and MMC messages.
When assigned to an expression pedal, messages are output once the pedal is pressed downward past the halfway point; when assigned to a control pedal or other switch, the messages are output when the switch is on.
- P.BEND / CH.PRS
These transmit various Pitch Bend messages and Channel Pressure messages.
When assigned to an expression pedal, consecutive values are output within the range set with the Range parameter. When assigned to a control pedal, the maximum value is output when the switch is on, and the minimum value is output when the switch is off.

NOTE

The settings made for the pedals are lost when the pedal settings are switched. To save settings made for the pedals, save them as pedal settings. For more detailed information, see “Storing Controller Numbers Assigned to the Pedals (Pedal Settings)” (p. 26).

Range

This sets the range for values that are transmitted.

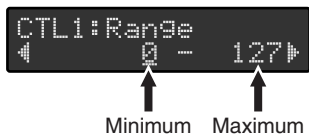

Mode

This sets the switch mode.



Value	Explanation
LATCH	The ON and OFF will alternate each time you press the pedal.
MOMENTARY	The value will be ON while you press the pedal, and OFF when you release the pedal.

AMP Ctl Op (Amp Control Operation)

This selects whether or not the AMP CONTROL jack is to be controlled.

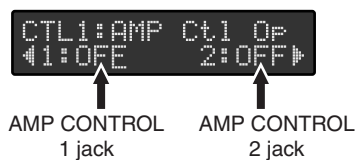

When the AMP Ctl Op parameter is set to ON and the AMP Polarity parameter is set to Normal, control of AMP CONTROL with the pedal functions as shown below.

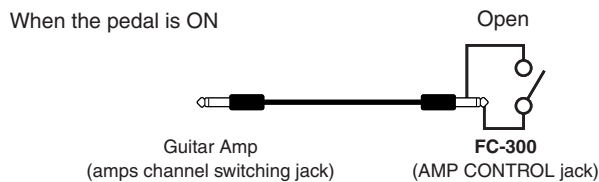
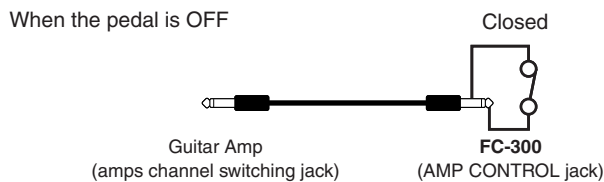

4 When you have finished with the editing, press [EXIT].

The top screen appears.

5 After making the changes, follow the instructions in “Storing Controller Numbers Assigned to the Pedals (Pedal Settings)” (p. 26) to save the settings.

MEMO

The Range parameter is enabled when CC#, P.BEND, or CH.PRS is selected for the expression pedal.

MEMO

The Mode parameter and AMP Ctl Op parameter are enabled when a control pedal or other switch function is selected.

NOTE

The settings made for the pedals are lost when the pedal settings are switched. To save settings made for the pedals, save them as pedal settings. For more detailed information, see “Storing Controller Numbers Assigned to the Pedals (Pedal Settings)” (p. 26).

cf.

You can change the polarity of the AMP CONTROL jacks. For more detailed information, see “Setting the Polarity of the AMP CONTROL Jacks” (p. 50).

Storing Controller Numbers Assigned to the Pedals (Pedal Settings)

The FC-300 can store up to five different configurations of settings made for all of the pedals (“**Change the Pedal Settings**” (p. 24)) in Control Change mode. These configurations are called pedal settings, and you can switch them as needed.

1 After completing the pedal settings (p. 24), press [WRITE] in the top screen of the Control Change Mode.

2 Select the number (1–5) for the pedal settings you want to store with VALUE [▼][▲].



↑
The store-destination
of the pedal setting

3 Press [WRITE].
“Sure?” appears in the display.

4 If you want to write the setting, press [WRITE]; if you want to cancel the procedure, press [EXIT].

Switching Control Numbers Assigned to the Pedals Simultaneously

1 With the Control Change Mode screen displayed, press VALUE [▼][▲].

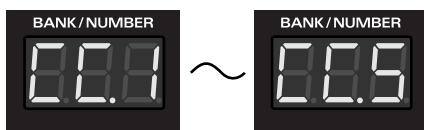

The pedal settings are switched, and the current pedal setting number is indicated in the BANK/NUMBER display.

Deleting a Pedal Setting

- 1** Press [WRITE] in the top screen of the Control Change Mode.
- 2** Pressing PARAMETER [◀][▶] to show the “Delete” screen.
- 3** Select the number (1–5) for the pedal settings you want to delete with VALUE [▼][▲].



```
Delete [WRITE]
PEDAL SETTING
```

The erased pedal setting

- 4** Press [WRITE].
“Sure?” appears in the display.
- 5** If you want to delete the setting, press [WRITE]; if you want to cancel the procedure, press [EXIT].

System Exclusive Mode

This mode is for transmitting and receiving System Exclusive messages.

Pressing the FC-300's pedals and pedals connected to the EXP PEDAL/CTL jacks transmits the pedal status via System Exclusive messages.

In addition, display content and pedal indicators can be switched with System Exclusive messages received by the FC-300.

* *For more on the System Exclusive messages transmitted and received in System Exclusive mode, refer to the "**MIDI Implementation** (p. 59)."*

Patch Mode

About the Patch Mode

This mode is used for storing combinations of multiple MIDI messages that you can combine freely and transmitting these messages together in groups.

This mode allows you to control the settings for multiple devices, all just with the FC-300.

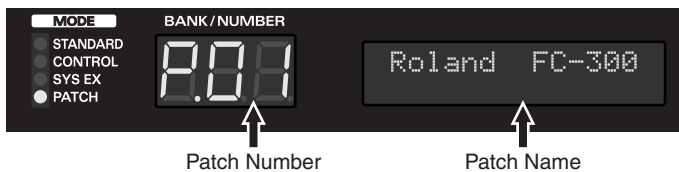

MEMO

When a patch name is set, the patch name is indicated in the top screen in Patch Mode.

About the Patch

A “patch” is a group of multiple MIDI messages (MIDI stream) and other settings that are configured together as a single unit. The FC-300 can store up to 100 individual patches.(p. 44)

The patch can set the following parameters.

- Patch's ON Stream
Group of MIDI messages transmitted when a patch is selected.
 - Patch's OFF Stream
Group of MIDI messages transmitted when a different patch is selected or when a pedal is released. These are used for canceling settings from ON streams.
 - Timing for transmission of the patch's OFF stream
 - CTL1,2 ON streams
These are the groups of MIDI messages transmitted when the pedals are switched on.
 - CTL1,2 OFF streams
These are the groups of MIDI messages transmitted when the pedals are switched off.
 - AMP CONTROL
You can set the status of the AMP CONTROL jacks when a patch is selected.
 - Control pedal, expression pedal, and other settings
 - Patch names
- * An individual patch can hold MIDI messages containing up to a maximum of approximately 500 bytes. Although the total amount of MIDI message data that can be stored in Patch Mode is approximately 8 Kbytes, this amount of memory is shared by all patches. Therefore, please note that not all patches can contain the full approximately 500 bytes.

MEMO

A “MIDI stream” is a number of MIDI messages grouped together.

Transmitting Control Change Messages

You can transmit Control Change messages through operation of the expression pedals, control pedals, and other controllers.

Using the Expression Pedals

In keeping with the movement of the expression pedal, Control Change messages with the controller numbers set for each pedal are transmitted consecutively.

Each pedal is set at the factory as shown below.

Expression Pedal	CC#	Range
EXP PEDAL 1 (Assign Number=1)	7	0-127
EXP PEDAL 2 (Assign Number=1)	1	0-127

All Assign Numbers from 2 on are set to OFF. For more information about the Assign Numbers, see “**Change the Pedal Settings**” (p. 42).

Using the Control Pedals and Expression Pedal Switches

You can connect separately available footswitches and expression pedals and use the external pedals just like the FC-300's pedals to transmit MIDI messages.

Each pedal is set at the factory as shown below.

Pedal	CC#	Range	Mode
CTL PEDAL 1	80	0-127	LATCH
CTL PEDAL 2	81	0-127	LATCH
EXP PEDAL SW 1 (Assign Number=1)	82	0-127	LATCH
EXP PEDAL SW 2 (Assign Number=1)	83	0-127	LATCH

All Assign Numbers from 2 on are set to OFF. For more information about the Assign Numbers, see “**Change the Pedal Settings**” (p. 42).

cf.

For details about the all parameters and changes the setting, refer to “**Change the Pedal Settings**” (p. 42).

cf.

The Control pedal and EXP pedal are the latch type pedal that sends an ON or OFF message each time you depress it. You can change this to momentary type operation, which sends an ON message when depressed and an OFF message when released – see “**Mode**” (p. 43).

cf.

You can use the control pedal and expression pedal switch to switch the AMP CONTROL jacks – see “**Change the Pedal Settings**” (p. 42).

Using the External Control Pedals and Expression Pedals

You can connect separately available footswitches and expression pedals and use the external pedals just like the FC-300's pedals to transmit Control Change messages, Realtime messages, and other such data.

When a BOSS FS-5U, FS-6 Footswitch is Connected, Assigned to CTL Pedal:

These function in the same way as the FC-300's built-in control pedals.

Connect a control pedal to the EXP PEDAL/CTL jack and set the FC-300 to enable use of the pedal. (p. 50)

- * If you have two FS-5U pedals or an FS-6 pedal connected to the CTL3,4 jack with a special PCS-31 connecting cable (from Roland; available separately), the footswitch connected to the plug with the white ring controls the setting of CONTROL 3, and the footswitch connected to the plug with the red ring controls the setting of CONTROL 4.
- * When only one footswitch is connected to the CTL3,4 jack, the CONTROL 3 settings are enabled.
- * When an FS-6 is connected to the CTL3,4 jack with an optional connection cable (stereo 1/4" phone \leftrightarrow stereo 1/4" phone), pedal switch B operates according to the CONTROL 3 settings, and pedal switch A operates according to the CONTROL 4 settings.

When a Roland EV-5, BOSS FV-500L or FV-500H is Connected, Assigned to Expression Pedal:

These function in the same way as the FC-300's built-in expression pedals.

Connect an expression pedal to the EXP PEDAL/CTL jack and set the FC-300 to enable use of the pedal. (p. 50)

- * These do not operate as expression pedal switches.
- * If you are connecting a BOSS FV-500L or FV-500H, connect the pedal with an optional connection cable (stereo 1/4" phone \leftrightarrow stereo 1/4" phone).

The Controller Number of Each Pedal

Each pedal is set at the factory as shown below.

Pedal	CC#	Range	Mode
CTL3	76	0-127	LATCH
CTL4	75	0-127	LATCH
CTL5	10	0-127	LATCH
CTL6	91	0-127	LATCH
CTL7	11	0-127	LATCH
CTL8	64	0-127	LATCH
EXP PEDAL 3	76	0-127	-
EXP PEDAL 4	10	0-127	-
EXP PEDAL 5	11	0-127	-

cf.

For details about the all parameters and changes the setting, refer to "Change the Pedal Settings" (p. 42).

cf.

See "Making the Connections" (p. 11) for instructions on setting the polarity switch and mode switch for the connected pedal.

cf.

You can set the range for values that are transmitted, refer to "Change the Pedal Settings" (p. 42).

Transmitting Patch Data

When a patch is selected with the [▼] and [▲] pedals and number pedals, the MIDI messages saved to the patch are transmitted.

1

Press the [▼] pedal, and the numbers decrease by five; press the [▲] pedal, and the numbers increase by five.

The BANK/NUMBER display and Number pedal indicators flash.

2

The numbers are selected by pressing the number pedals (1/6–5/10).

The patch for the selected number is selected (the pedal's indicator lights), and the MIDI messages in the ON stream within the patch are transmitted.

Additionally, other settings included in the patch are enabled. A current patch's OFF streams are transmitted before the newly selected patch's ON streams are transmitted.

cf.

With the factory settings, Program Change messages are not transmitted just by pressing the [▼] and [▲] pedals.

To transmit Program Change messages just by pressing the [▼] and [▲] pedals, read **“Using the [▼] [▲] Pedals to Make the Settings”** (p. 48).

cf.

You can program the FC-300 so that pressing the [▼] and [▲] pedals changes patch numbers ten at a time. For details, refer to **“Setting the [▼] [▲] Pedal Step Size”** (p. 49).

cf.

You can release the number pedal to transmit OFF stream at a time. For more detailed information, see **“Setting the Timing for Transmission of OFF MIDI Streams”** (p. 40).

MEMO

Patch Number 100 is indicated as P.00.

Creating Patches

In the Patch Mode's top screen, when press PARAMETER [►], the various pedal setting screens appear in the display. Press PARAMETER [◀] [►] to select the parameter you want to change.

The patch can set the following parameters.

- Patch's ON Stream
- Patch's OFF Stream
- The Transmit timing of the patch's Off Stream
- ON Stream of the CTL pedal 1, 2
- OFF Stream of the CTL pedal 1, 2
- Amp Control
- Control Pedal, Expression Pedal, and Other Settings
- Patch Name

You can assign the following messages to ON streams and OFF streams.

Message		Display	
Channel Message	Program Change Message	PC	
	Control Change Message	CC	
	Note On/Note Off Message	N.ON/N.OFF	
	Channel Pressure Message	C.PRS	
	Polyphonic Key Pressure Message	K.PRS	
	Pitch Bend Message	P.BEND	
Realtime Message		REALTIME	MIDI START MIDI STOP MIDI CONTINUE
System Exclusive Message		SYSEX	

NOTE

If you switch patches before saving the MIDI messages you have input to the patch, any edited content is lost. To save the changes you have made, carry out the Write procedure, refer to “**Storing (Saving) Patches**” (p. 44).

Editing MIDI Streams

1 In the Patch Mode's top screen, press **PARAMETER** [▶].

2 Use the **PARAMETER** [◀] and [▶] buttons to select the MIDI stream you want to edit, then press **[WRITE]**.



```
PATCH: On MIDI
      [WRITE]▶
```

3 "Edit MIDI" appears in the screen; press **[WRITE]**.

The screen for selecting the MIDI stream editing function appears.



```
Edit MIDI
      [WRITE]▶
```

The following display appears when the message is not assigned.

Message Number



```
001:-----
.....
```

4 Use the **VALUE** [▼] and [▲] to select the message number for the message to be edited.

If you are adding any message, press **[INS]**. The message is added before the number of the currently selected message.

To delete a message, select the message number with **VALUE** [▼][▲] then press **[DEL]**.

5 Use the following procedures to edit the MIDI stream for different types of messages.

MEMO

You can select only one point to which no messages at all are assigned.

When Setting Channel Messages and Realtime Messages

1

Press **PARAMETER** [◀] [▶] to move the cursor to the MIDI message.

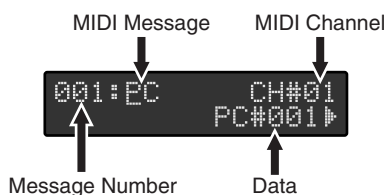

2

Press **VALUE** [▼] [▲] to select the MIDI message to be edited.

MIDI Message	Data
PC	MIDI Channel (CH#), Program Number (PC#)
CC	MIDI Channel (CH#), Controller Number (CC#), Value (VAL)
N.ON	MIDI Channel (CH#), Note Number (NOTE#), Velocity (V)
N.OFF	MIDI Channel (CH#), Note Number (NOTE#), Velocity (V)
C.PRS	MIDI Channel (CH#), VALUE
K.PRS	MIDI Channel (CH#), Note Number (NOTE#), Velocity (V)
P.BEND	MIDI Channel (CH#), Value (MSB, LSB)
REALTIME	MIDI START/MIDI STOP/MIDI CONTINUE

3

Press **PARAMETER** [◀] [▶] to move the cursor to the parameter you want to change.

4

Press **VALUE** [▼] [▲] to change the value.

If there is any other message you want to change, select the message number as instructed in Step 4 of “**Editing MIDI Streams**” (p. 34), then repeat Steps 1-4.

5

After making the changes, follow the instructions in “**Storing (Saving) Patches**” (p. 44) to save the MIDI messages to a patch.

MEMO

When the MIDI channel is set to Tx, the channel set with the MIDI:Tx Channel parameter in Utilities is set (p. 52).

When Setting System Exclusive Messages

- 1** Press **PARAMETER** [◀] [▶] to move the cursor to the MIDI message.

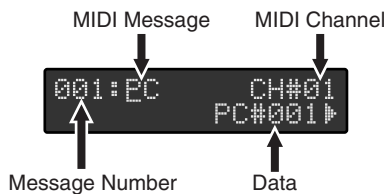

- 2** Press **VALUE** [▼] [▲] to select the “SYSEX.”

```
001:SYSEX[WRITE]
4 Template▶
```

- 3** Press **[WRITE]** to display the advanced editing screen.

```
F0 41 F7
```

- 4** Press **PARAMETER** [◀] [▶] to move the cursor to the data you want to change.

- 5** Press **VALUE** [▼] [▲] to change the value.

- 6** If you want to add a data, use **PARAMETER** [◀] [▶] to move the cursor to the position where you want to make the addition, then press **[INS]**. If you want to delete a data, use **PARAMETER** [◀] [▶] to move the cursor to the position where you want to delete, then press **[DEL]**.

Repeat steps 4–6, edit the data.

- 7** When you have finished with the editing, press **[EXIT]**.

- 8** After making the changes, follow the instructions in “Storing (Saving) Patches” (p. 44) to save the MIDI messages to a patch.

MEMO

The maximum amount of data that can be saved to a system exclusive message is 256 bytes.

MEMO

With Roland System Exclusive messages, moving the cursor to the message in front of F7 (the end of the transmitted data) and pressing **[WRITE]** performs a checksum and inserts it there.

When Setting System Exclusive Messages Using the Template

When assigning the following System Exclusive messages, use the template.

Template		
GM SYS ON	MMC PLAY	MMC REC EXIT
GM SYS OFF	MMC DEF PLAY	MMC REC PAUSE
V-LINK ON	MMC FAST FWD	MMC PAUSE
V-LINK OFF	MMC REWIND	MMC RESET
MMC STOP	MMC REC STROBE	MMC LOCATE

- 1 Press PARAMETER [◀] [▶] to move the cursor to the MIDI message.

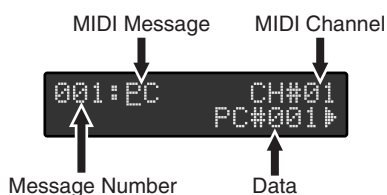

- 2 Press VALUE [▼] [▲] to select the "SYSEX."

- 3 Press PARAMETER [▶] to move the cursor to the "Template."



- 4 Press [WRITE] to display the template selection screen.



- 5 Press VALUE [▼] [▲] to select the template.

- 6 Press [WRITE].

The contents of the template are input in the MIDI stream.

- 7 After making the changes, follow the instructions in "Storing (Saving) Patches" (p. 44) to save the MIDI messages to a patch.

Copying and Moving MIDI Messages Within a Stream

You can copy MIDI messages saved within a MIDI stream.

Use this function when you want to program a number of similar messages in a stream.

Messages in MIDI streams are output in the same order they are programmed.

To change the sequence of the messages in a stream, use the Move function.

1 Press PARAMETER [◀] [▶] to move the cursor to message number.

2 Press VALUE [▼] [▲] to select you want to copy (or move) message number.

3 Press PARAMETER [◀] [▶] to select the “MOVE” or “COPY.”

A rectangular LCD display with a dark background and light-colored text. The top line shows '001:SYSEX' and the bottom line shows '4 Move [WRITE]'.

A rectangular LCD display with a dark background and light-colored text. The top line shows '001:SYSEX' and the bottom line shows '4 Copy [WRITE]'.

4 Press [WRITE].

5 Press VALUE [▼] [▲] to select the copy destination (or move destination) message number.

The copy (or move) message is inserted to the in front of the selected message number.

A rectangular LCD display with a dark background and light-colored text. The top line shows 'Move to [WRITE]' and the bottom line shows '001:SYSEX'.

6 Press [WRITE].

7 “Sure?” appears in the display; press [WRITE] once more.

A rectangular LCD display with a dark background and light-colored text. The top line shows 'Sure? [WRITE]' and the bottom line shows '001:SYSEX'.

8 After making the changes, follow the instructions in “Storing (Saving) Patches” (p. 44) to save the MIDI messages to a patch.

How to Copy MIDI Streams

You can copy an edited stream to a different patch or different stream.

1 In the Patch Mode's top screen, press **PARAMETER** [▶].

2 Press **PARAMETER** [◀][▶] to select the stream to be used as the copy source, then press **[WRITE]**.

```
PATCH: On MIDI
[WRITE]▶
```

3 Press **PARAMETER** [◀][▶] to select "Copy MIDI," then press **[WRITE]**.

```
Copy MIDI
4 [WRITE]▶
```

4 Press **VALUE** [▼][▲] to select the stream to be used as the copy source, then press **[WRITE]**.

```
Copy from[WRITE]
01:
```

5 Press **VALUE** [▼][▲] to select the stream to be used as the copy destination, then press **[WRITE]**.

```
Copy from[WRITE]
PATCH On
```

6 "Sure?" appears in the display; press **[WRITE]** once more.

```
Sure? [WRITE]
01-PATCH On
```

7 After making the changes, follow the instructions in "Storing (Saving) Patches" (p. 44) to save the MIDI messages to a patch.

How to Delete MIDI Streams

You can delete content in streams.

1 In the Patch Mode's top screen, press PARAMETER [▶].

2 Press PARAMETER [◀][▶] to select the stream from which you want to delete data, then press [WRITE].



3 Press PARAMETER [◀][▶] to select "Delete MIDI," then press [WRITE].



4 "Sure?" appears in the display; press [WRITE] once more.



5 After making the changes, follow the instructions in "Storing (Saving) Patches" (p. 44) to save the MIDI messages to a patch.

Setting the Timing for Transmission of OFF MIDI Streams

1 In the Patch Mode's top screen, press PARAMETER [▶].

2 Press PARAMETER [◀][▶] to select "Off Timing."



↑
Setting the timing
for transmission

3 Press VALUE [▼][▲] to set the value.

Value	Explanation
PEDAL RELEASE	After the patches are switched, the OFF stream is transmitted when the pedal is released.
PATCH CHANGE	The stream is transmitted when the next patch is selected. The OFF stream is transmitted immediately before the ON stream for the next patch is transmitted.

4 After making the changes, follow the instructions in "Storing (Saving) Patches" (p. 44) to save the MIDI messages to a patch.

MEMO

The Off Timing parameter is set to PATCH CHANGE when shipped from the factory.

Setting the Amp Control

You can set the status of the AMP CONTROL jacks when patches are selected.

1 In the Patch Mode's top screen, press **PARAMETER** [▶].

2 Press **PARAMETER** [◀][▶] to select "AMP Ctl."

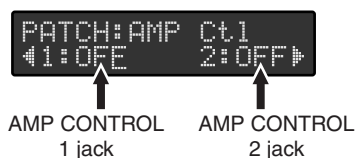

3 Press **PARAMETER** [◀][▶] to select "1" or "2" of the AMP Ctl.

4 Press **VALUE** [▼][▲] to change the value.

Control of AMP CONTROL when the AMP Pol. parameter (p. 50) is set to NORMAL is as shown below.

Value	Explanation
---	The AMP CONTROL jack is disabled.
OFF	The AMP CONTROL jack is switched off (closed).
ON	The AMP CONTROL jack is switched on (open).

When the AMP Ctl is OFF

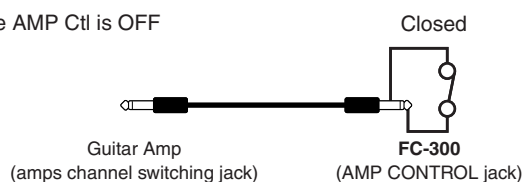

When the AMP Ctl is ON

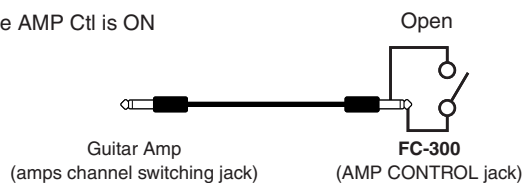

5 After making the changes, follow the instructions in "Storing (Saving) Patches" (p. 44) to save the setting to a patch.

cf.

You can change the polarity of the AMP CONTROL jacks. For more detailed information, see "Setting the Polarity of the AMP CONTROL Jacks" (p. 50).

Change the Pedal Settings

You can freely change the settings for each pedal.

1 In the Patch Mode's top screen, press **PARAMETER** [▶].

2 Press **PARAMETER** [◀] [▶] to select the each pedal settings screen.

The pedals being set appear at the left and upper of the screen.

You can set the following parameters:

- ON Stream
- OFF Stream
- Control Change Message (The pedal can be assigned to up to six messages.)
- Amp Control

3 Press **VALUE** [▼] [▲] to change the value.

Setting the ON Stream and OFF Stream

You can assign these in the same manner as streams set as patch parameters. (p. 34)

However, the timing for transmission of OFF streams follows the settings made in Pedal mode. You can set ON streams and OFF streams only with the FC-300's CTL pedals.

Assign Number

The EXP PEDAL and EXP PEDAL SW can be assigned to up to six messages to be transmitted. You can also assign one message to be transmitted to each of the pedals connected to the rear panel's EXP PEDAL/CTL jacks and FC-300's CTL pedals.

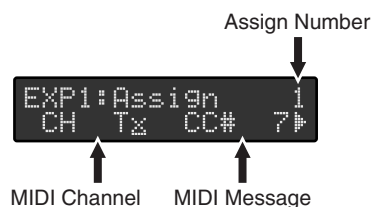

MIDI Channel

This sets the MIDI channel for the messages being transmitted.

MIDI Messages

This sets the range for values that are transmitted.

- Off

These do not output MIDI messages.

- CC#1 – CC#31, CC#33 – CC#95

These output Control Change messages.

When used to an expression pedal, consecutive values are output within the range set with the Range parameter. When used to a control pedal, the maximum value is output when the switch is on, and the minimum value is output when the switch is off.

- MIDI START / MIDI STOP / MIDI CONTINUE / MMC STOP / MMC PLAY / MMC DEF PLAY / MMC FAST FWD / MMC REWIND / MMC REC STROBE /

MEMO

When the MIDI channel is set to Tx, the channel set with the MIDI:Tx Channel parameter in Utilities is set (p. 52).

MMC REC EXIT / MMC REC PAUSE / MMC PAUSE

This transmits MIDI Realtime messages and MMC messages.

When assigned to an expression pedal, messages are output once the pedal is pressed downward past the halfway point; when assigned to a control pedal or other switch, the messages are output when the switch is on.

- P.BEND/CH.PRS

These transmit various Pitch Bend messages and Channel Pressure messages.

When assigned to an expression pedal, consecutive values are output within the range set with the Range parameter. When assigned to a control pedal, the maximum value is output when the switch is on, and the minimum value is output when the switch is off.

Range

This sets the range for values that are transmitted.

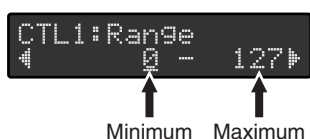

Mode

This sets the switch mode.



Value	Explanation
LATCH	The ON and OFF will alternate each time you press the pedal.
MOMENTARY	The value will be ON while you press the pedal, and OFF when you release the pedal.

AMP Ctl Op (Amp Control Operation)

This selects whether or not the AMP CONTROL jack is to be controlled.

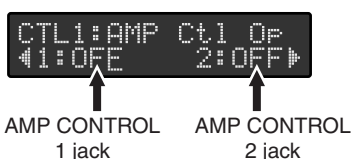

Control of AMP CONTROL using a pedal when the AMP Ctl Op parameter is set to ON and the AMP Pol. parameter (p. 50) is set to NORMAL is as shown below.

When the pedal is OFF

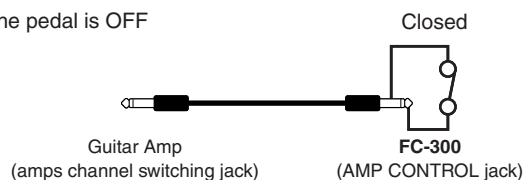

When the pedal is ON

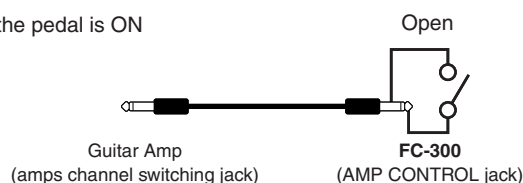

MEMO

The Range parameter is enabled only when CC#, P.BEND, or CH.PRS is selected.

MEMO

The Mode parameter and AMP Ctl Op parameter are enabled with control pedals and other such switches. These parameters are disregarded when the pedal is used as an expression pedal.

cf.

You can change the polarity of the AMP CONTROL jacks. For more detailed information, see "Setting the Polarity of the AMP CONTROL Jacks" (p. 50).

Patch Mode

- 4 When you have finished with the editing, press [EXIT].
The top screen appears.

- 5 After making the changes, follow the instructions in “Storing (Saving) Patches” (p. 44) to save the setting to a patch.

NOTE

The settings made for the pedals are lost when the patch is switched. To save settings made for the pedals, save them as a patch. For more detailed information, see “Storing (Saving) Patches” (p. 44).

Set the Patch Name

- 1 In the Patch mode’s top screen, press PARAMETER [▶].

- 2 Press PARAMETER [◀][▶] to select “Patch Name.”



```
Patch Name
└─
```

- 3 Press PARAMETER [▶] to move the cursor, and press VALUE [▼][▲] to enter the characters.

MEMO

Patch names can be up to 12 characters in length.

MEMO

When you press [INS], inserts a blank space at the cursor location. When you press [DEL], deletes a character at the cursor location.

MEMO

Patch names are indicated in the top screen in Patch Mode.

Storing (Saving) Patches

To store patches you have created in memory, carry out the Write procedure.

- 1 In the Patch mode’s top screen, press [WRITE].



```
Write to [WRITE]
01: ─▶
```

- 2 Press VALUE [▼][▲] to select the save-destination patch number, then press [WRITE].

- 3 “Sure?” appears in the display; press [WRITE] once more.



```
Sure? [WRITE]
01: ─▶
```

The set value is saved, and the FC-300 returns to the top screen.

Deleting Patches

You can delete entire patches.

1

Select the patch you want to delete in the Patch mode's top screen, then press [WRITE].

```
Write to [WRITE]
01:      ▶
```

2

Press PARAMETER [▶] to select "Delete."

```
Delete [WRITE]
01:
```

3

Press [WRITE].

4

"Sure?" appears in the display; press [WRITE] once more.

```
Sure? [WRITE]
01:
```

The selected patch is deleted, and the FC-300 returns to the top screen.

Other Features

Setting the System Parameters

Set the system parameters with the following procedure.

- 1** Press [UTILITY].
The [UTILITY] indicator lights, and the Utility screen appears in the display.
- 2** Press PARAMETER [◀][▶] to call up the parameter you want to set.
Parameters that can be set and their screens are described in the next section.
- 3** Press VALUE [▼][▲] to set the various parameters.
- 4** When you've finished making the settings, press [UTILITY] or [EXIT].
The data is saved, and FC-300 returns to the top screen.

Adjusting the LCD Contrast

Depending on where the FC-300 is placed, the display (on the right) may become difficult to read.

If this occurs, adjust the display contrast.

- 1** Press PARAMETER [◀][▶] to select "SYS:LCD Contrast."



SYS:LCD Contrast
15▶

- 2** Press VALUE [▼][▲] to adjust the contrast.

- 3** When you've finished making the settings, press [UTILITY] or [EXIT].

Reducing Battery Consumption (Economy Mode)

When the FC-300 is run on battery power, setting Economy Mode to ON enables approximately 1.8 times continuous running time of the normal FC-300's operating mode.

- 1** Press PARAMETER [◀][▶] to select "SYS:Economy Mode."



SYS:Economy Mode
4 OFF▶

- 2** Press VALUE [▼][▲] to switch Economy Mode on and off.

- 3** When you've finished making the settings, press [UTILITY] or [EXIT].

MEMO

The display and indicators may flicker when Economy Mode is set to ON, but this does not indicate a malfunction.

Setting the Method Used for Transmitting Program Change messages in Standard Mode (PC Mode)

You can change the method used for transmitting program changes to match the device connected to the FC-300.

1

Press **PARAMETER** [◀] [▶] to select “SYS:PC Mode.”



2

Press **VALUE** [▼] [▲] to make the setting.

Value	Explanation
EFFECTS	Optimal mode for switching effects processor patches
SOUND MODULE	Optimal mode for switching sound module patches

When PC Mode parameter sets to “EFFECTS” and SYS:Bank Display parameter sets to “LINEAR,” the FC-300’s BANK/NUMBER display and the transmitted bank select messages and program change messages correspond as shown below.

BANK/NUMBER Display	Bank Select message		Program Change message
	(MSB)	(LSB)	
001–128	0	0	1–128
129–200	1	0	29–100
201–300	2	0	1–100
301–400	3	0	1–100
401–500	4	0	1–100
501–600	5	0	1–100
601–700	6	0	1–100
701–800	7	0	1–100
801–900	8	0	1–100
901–990	9	0	1–90

When set to “SOUND MODULE,” the FC-300’s LCD appears bank select MSB and LSB, and the transmitted bank select message with program change message.

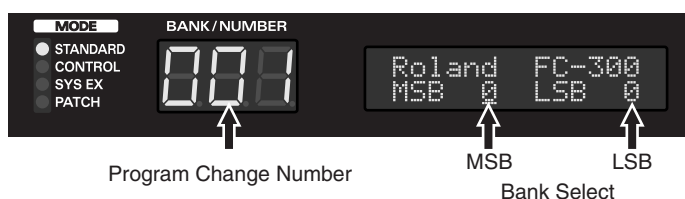

3

When you’ve finished making the settings, press **[UTILITY]** or **[EXIT]**.

MEMO

When PC Mode is set to EFFECTS, the Bank Select messages actually output include the Bank Select in the table at the left together with the Bank Select set with the UTILITY MIDI:Bank Select parameter (p. 47).

MEMO

You can switch how information is indicated in the BANK/NUMBER display (p. 49).

cf.

The MIDI Bank Select setting increases and decreases the MSB. You can also have this change the LSB. For more detailed information, see “Setting the Bank Select Output” (p. 52).

MEMO

When PC Mode is set to SOUND MODULE, the MSB and LSB values upon power-up will be the values set in MIDI:Bank Select.

Using the [▼] [▲] Pedals to Make the Settings

1

Press PARAMETER [◀] [▶] to select “SYS:Bank Chg Mode.”

2

Press the VALUE [▼] [▲] to program the settings.

Here are some examples of operation in Standard Mode.

Value	Explanation
IMMEDIATE	Program changes are transmitted immediately when [▼] or [▲] is pressed. Example) When starting from “003,” pressing [▲] simultaneously transmits PC#8.
WAIT FOR A NUM	Program changes are transmitted when a number pedal is pressed after [▼] or [▲] is pressed. Example) Starting from “003,” after [▲] is pressed and all of the green number pedal indicators are flashing, pressing number pedal 8 outputs PC#8.
RESET NUMBER	Although program changes are transmitted immediately when [▼] or [▲] is pressed, just as with Immediate, in this case, the number furthest to the left is output. Example) If starting from “003,” pressing [▲] simultaneously transmits PC#6.

3

When you’ve finished making the settings, press [UTILITY] or [EXIT].

Limiting the Range of Banks That Can Be Switched (Bank Extent)

You can set an upper limit on the banks that can be switched, thus limiting the range of banks that are switched and allowing you to select only the patches required.

1

Press PARAMETER [◀] [▶] to select “SYS:Bank Extent.”

2

Press VALUE [▼] [▲] to set the upper limit on the banks.

3

When you’ve finished making the settings, press [UTILITY] or [EXIT].

MEMO

This is enabled only when PC Mode is set to EFFECTS.

Setting the [▼] [▲] Pedal Step Size

You can set the size of the step made when the [▼] [▲] pedals are pressed.

1

Press **PARAMETER** [◀] [▶] to select “SYS:Bank Step.”



2

Press **VALUE** [▼] [▲] to make the setting.

Value	Explanation
5STEP	The number decreases or increases by five each time [▼] or [▲] is pressed.
10STEP	The number decreases or increases by ten each time [▼] or [▲] is pressed. Additionally, each time a number pedal is pressed, that pedal's number is switched. Example) When “012” is indicated in BANK/NUMBER display, pressing number pedal 2/7 switches it to “017.”

3

When you've finished making the settings, press [UTILITY] or [EXIT].

Setting How Numbers are Indicated

You can select the way numbers are indicated in Standard Mode to match that of the connected device.

1

Press **PARAMETER** [◀] [▶] to select “SYS:Bank Display.”



2

Press **VALUE** [▼] [▲] to make the setting.

Value	Explanation
LINEAR	The bank and number are indicated as a single decimal number.
BANK&NUM	The bank and number are indicated as separate numbers. A dot is displayed between the bank and number. Example) The number indicated in LINEAR as “001” appears as “01.1” with BANK&NUM.
FC-200	The numerals are indicated in the same way as with BANK & NUM, but with the banks beginning with “00” in the display.

3

When you've finished making the settings, press [UTILITY] or [EXIT].

Setting the Polarity of the AMP CONTROL Jacks

Change this parameter if the indicator on an amp connected to an AMP CONTROL jack (1 or 2) does not correspond to the ON indicator (indicator lit) on the FC-300.

1

Press **PARAMETER** [◀] [▶] to select “SYS:AMP 1 Pol.” or “SYS:AMP 2 Pol.”



2

Press **VALUE** [▼] [▲] to make the setting.

Value	Explanation
NORMAL	The parameter is set to the factory setting.
INVERT	Actual operation is the reverse of that indicated by the FC-300's ON/OFF indicator.

3

When you've finished making the settings, press [UTILITY] or [EXIT].

Determining the Role of an EXP PEDAL/CTL Jack

Follow the steps below to specify whether a pedal being connected to an EXP PEDAL/CTL jack (on the rear panel) is a control pedal or an expression pedal. This setting needs to be made individually for each jack.

1

Press **PARAMETER** [◀] [▶] to select “SYS:E3/C3 Type”, “SYS:E4/C5 Type” or “SYS:E5/C7 Type.”



2

Press **VALUE** [▼] [▲] to make the setting.

Value	Explanation
EXP PEDAL	The jack will be used for connecting expression pedals. Connect a Roland EV-5 or BOSS FV-500L or FV-500H.
CTL	The jack will be used for connecting control pedals. Connect a BOSS FS-5U or FS-6.

3

When you've finished making the settings, press [UTILITY] or [EXIT].

Switching the Function of the MODE Pedal Jack

This sets the modes that can be selected when the mode is switched with a pedal. This setting allows you to toggle only between the modes you need when using the pedal.

- 1 Press PARAMETER [◀] [▶] to select “SYS:MODE Pdl Seq.”

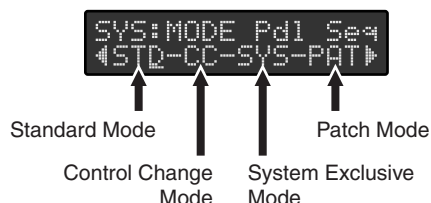

- 2 Press PARAMETER [◀] [▶] to select the mode you want to set, then press VALUE [▼] [▲] to make the setting.

Value	Explanation
Uppercase letters	These can be selected by pressing the pedal.
Lowercase letters	These cannot be selected by pressing the pedal.

- 3 When you’ve finished making the settings, press [UTILITY] or [EXIT].

MEMO

The actions performed by simultaneously pressing the [▼] and [▲] pedals also conform to this setting.

MEMO

You cannot set the lower case letters in all modes.

Switching How the Pedal Indicators Light

You can have all unlit pedal indicators flash faintly instead. This makes it easier to locate pedal positions on stage and in other darkened environments.

- 1 Press PARAMETER [◀] [▶] to select “SYS:Pdl Indicate.”



- 2 Press VALUE [▼] [▲] to make the setting.

Value	Explanation
OFF	All pedal indicators other than the lit pedal indicator remain off.
ON	All pedal indicators other than the unlit pedal indicator flash.

- 3 When you’ve finished making the settings, press [UTILITY] or [EXIT].

Setting the MIDI Transmit Channel

This sets the Transmit Channel of the MIDI messages.

- 1 Press PARAMETER [◀] [▶] to select “MIDI:Tx Channel.”



- 2 Press VALUE [▼] [▲] to set the transmit channel.

- 3 When you’ve finished making the settings, press [UTILITY] or [EXIT].

Setting the Device ID

This sets the Device ID used for transmitting and receiving system exclusive messages.

- 1 Press PARAMETER [◀] [▶] to select “MIDI:Device ID.”



- 2 Press VALUE [▼] [▲] to set the Device ID.

- 3 When you’ve finished making the settings, press [UTILITY] or [EXIT].

Setting the Bank Select Output

This setting determines whether or not Bank Select messages as well as Program Change messages are transmitted in Standard Mode.

- 1 Press PARAMETER [◀] [▶] to select “MIDI:Bnk Sel Out.”



- 2 Press VALUE [▼] [▲] to make the setting.

Value	Explanation
OFF	Bank Select messages are not transmitted.
ON (MSB INC)	The Bank Select (MSB) message is incremented (or decremented) by one when the Program Change is incremented (or decremented).
ON (LSB INC)	The Bank Select (LSB) message is incremented (or decremented) by one when the Program Change is incremented (or decremented).

- 3 When you’ve finished making the settings, press [UTILITY] or [EXIT].

Setting the Bank Select Value

You can change the values of the Bank Select messages output in Standard Mode to match the connected device. Values from the [▼] [▲] pedals are added to the base values set here and then output. For details, refer to “**Setting the Method Used for Transmitting Program Change messages in Standard Mode (PC Mode)**” (p. 47).

1

Press PARAMETER [◀] [▶] to select “MIDI:Bank Select.”



MIDI:Bank Select
◀MSB 1 LSB 0▶

2

Press PARAMETER [◀] [▶] to select either “MSB” or “LSB.”

3

Press VALUE [▼] [▲] to make the setting.

4

When you’ve finished making the settings, press [UTILITY] or [EXIT].

Transmitting Data to an External MIDI Device (Bulk Dump)

On the FC-300, you can use System Exclusive messages to provide another FC-300 with identical settings, and save settings on a MIDI sequencer or other device.

Making the Connections

- When saving to a MIDI sequencer
Connect the FC-300’s MIDI OUT to the MIDI sequencer’s MIDI IN connector with a MIDI cable.
 - When transmitting data to another FC-300
Connect the sending FC-300’s MIDI OUT to the receiving FC-300’s MIDI IN connector with a MIDI cable.
1. Set the Device ID for the transmitting and receiving FC-300s to the same ID (p. 52).
 2. Switch to the Bulk Load screen on the receiving FC-300 (p. 54).

Transmitting

1

Press PARAMETER [◀] [▶] to select “Bulk Dump.”



Bulk Dump [WRITE]
◀ ALL ▶

MEMO

For instructions on operating the MIDI sequencer, see the owner’s manual that came with your MIDI sequencer.

2

Press VALUE [▼] [▲] to make the setting.

Value	Explanation
ALL	All settings (UTILITY, STANDARD, CONTROL, PATCH) are transmitted.
UTILITY	System parameter settings are transmitted.
STANDARD	Standard Mode settings are transmitted.
CONTROL	Control Change Mode settings are transmitted.
PATCH	Patch Mode settings are transmitted.

3

Press [WRITE].

The “Now Sending...” message appears in the display when the FC-300 sends the data. The top screen appears in the display when the FC-300 finishes sending the data.

If either ALL, CONTROL, or PATCH is selected in Step 2, the message “Erase Tmp Data Sure?” is displayed.

Press [WRITE] again; the data currently being edited (unsaved) in Control Change mode and Patch mode is erased, and then the bulk dump begins.

Receiving Data from an External MIDI Device (Bulk Load)

FC-300 can receive the setting saved in the sequencer or the other FC-300 with identical settings.

Making the Connections

- When receiving data saved to a MIDI sequencer
Connect the MIDI sequencer’s MIDI OUT to the FC-300’s MIDI IN connector with a MIDI cable.

Transmitting

1

Press PARAMETER [◀] [▶] to select “Bulk Load.”



Bulk Load
Now Waiting...

2

Transmit the data.

The “Now Receiving...” message appears in the display when the FC-300 receiving the data.

The bulk load processing ended when the message “Now Waiting...” appears in the display.

3

When you’ve finished receiving the data, press [UTILITY] or [EXIT].

The data is saved, and the FC-300 returns to the top screen.

MEMO

For instructions on operating the MIDI sequencer, see the owner’s manual that came with your MIDI sequencer.

MEMO

Just as when transmitting data to a MIDI sequencer, match the FC-300’s and MIDI sequencer’s Device ID settings (p. 52).

Restoring the Factory Settings (Factory Reset)

You can restore all of the FC-300's settings to their original factory settings.

This is referred to as "Factory Reset."

Use the following procedure when carrying out Factory Reset.

1

Switch off the power.

2

Hold down VALUE [▼] [▲] and switch on the power.

The message "Factory Reset Are you sure?" appears in the display.



```
Factory Reset
Are you sure?
```

3

Press [WRITE].

Factory Reset is executed.

When the Factory Reset is finished, the message "Completed!" appears in the display.

4

Switch off the power.

NOTE

Do not turn off the power to the FC-300 while Factory Reset is in progress.

MEMO

If you want to cancel the factory reset operation, turn off the power.

Adjusting the Expression Pedal

Although the FC-300's EXP pedals are adjusted for optimal performance when shipped from the factory, extended use over time and under certain usage conditions may result in the pedals going out of adjustment. If you find the pedals exhibiting problems, such as "a failure to completely shut off the volume when used as volume pedals," or "MIDI messages not being output in the range corresponding to the set values," you can readjust the pedals using the following procedure.

1 Hold down [UTILITY] and switch on the power.

2 When "EXP1:Set to MIN" is displayed, rock EXP PEDAL 1 all the way back (so that the toe end of the pedal is raised). Release your foot from EXP PEDAL 1, and then press [WRITE].

```
EXP1:Set to MIN
      [WRITE]
```

3 When "EXP1:Set to MAX" is displayed, rock EXP PEDAL 1 fully forward (so that the heel end of the pedal is raised). Release your foot from EXP PEDAL 1, and then press [WRITE].

```
EXP1:Set to MAX
      [WRITE]
```

4 When "EXP1:Threshold" appears in the display, set the sensitivity of the EXP PEDAL SW 1 with VALUE [▼][▲], and then press [WRITE].

```
EXP1:Threshold
      6 [WRITE]
```

5 When "EXP2:Set to MIN" is displayed, rock EXP PEDAL 2 all the way back (so that the toe end of the pedal is raised). Release your foot from EXP PEDAL 2, and then press [WRITE].

```
EXP2:Set to MIN
      [WRITE]
```

6 When "EXP2:Set to MAX" is displayed, rock EXP PEDAL 2 fully forward (so that the heel end of the pedal is raised). Release your foot from EXP PEDAL 2, and then press [WRITE].

```
EXP2:Set to MAX
      [WRITE]
```

7 When "EXP2:Threshold" appears in the display, set the sensitivity of the EXP PEDAL SW 2 with VALUE [▼][▲], and then press [WRITE].

```
EXP2:Threshold
      6 [WRITE]
```

8 When the message "Complete!" appears in the display, switch off the power.

NOTE

When you operate the expression pedal, please be careful not to get your fingers pinched between the movable part and the panel. In households with small children, an adult should provide supervision until the child is capable of following all the rules essential for the safe operation of the unit.

MEMO

EXP1:Threshold and EXP2:Threshold can be set to any value from 1 through 16. The expression pedal switch can be switched on and off with less pressure as the value is lowered.

Error Messages

Battery Low!

- [Cause] The batteries are depleted (6 x AA size).
[Solution] Replace the batteries as soon as possible. (p. 11)

Memory Full!

- [Cause 1] The internal memory became full at the time the patch was saved.
[Solution 1] Delete any unnecessary patches. (p. 45)
[Cause 2] The area of memory for the FC-300's internal operations became full while the patch was being edited (COPY, INS, etc).
[Solution 2] Delete MIDI messages within the patch. (p. 40)

MIDI Buffer Full!

- [Cause] Too many MIDI messages were received in a short time from an external MIDI device than could be processed correctly.
[Solution] Reduce the amount of MIDI message data transmitted by the external MIDI device.

MIDI Offline!

- [Cause] There is a problem with the MIDI cable connection.
[Solution] Check to make sure the cable has not been pulled out or is not defective.

RRC2 Buffer Full!

- [Cause] Too many RRC2 control messages were received in a short time from an external RRC2 IN device than could be processed correctly.
[Solution] Reduce the amount of control message data transmitted by the external RRC2 IN device.

RRC2 Offline!

- [Cause] There is a problem with the RRC2 cable connection.
[Solution] Check to make sure the cable has not been pulled out or is not defective.

Troubleshooting

If other operational problems occur, first check by using the following solutions:
If this does not resolve the problem, then contact your dealer or a nearby Roland service station.

The power doesn't come on

- **Is the specified AC adaptor (PSA series; sold separately) properly connected?**

Check connections again. Never use any AC adaptor other than one specified for use with the FC-300 (p. 12).

- **Are the batteries dead?**

Replace the new batteries (p. 11).

Power not turning off

- **Is there an RRC2 IN device connected?**

Switch the RRC2 IN device's POWER switch to OFF (p. 13).

MIDI messages are not transmitted/received

- **Are the MIDI cables broken?**

Try another set of MIDI cables.

- **Is the FC-300 correctly connected to the other MIDI device?**

Check connections with the other MIDI device.

- **Do the MIDI channel settings of both devices match?**

Make sure that the MIDI channels of both devices match (p. 52).

- **Is the number pedal indicator flashing?**

Program Change messages are not transmitted while the number pedal's indicator is flashing.

Pressing a number pedal and selecting the number transmits the message.

- **When you send messages from the FC-300, make sure the FC-300 is set to the settings appropriate for sending data.**

Check the "Setting the Method Used for Transmitting Program Change messages in Standard Mode (PC Mode)" (p. 47) or "Transmitting Control Change Messages" (p. 17) (p. 21) (p. 30).

Expression pedal switch not switching on and off / Fails to completely shut off the volume when used as a volume pedal

- **Has the pedal gone out of adjustment?**

Adjust the expression pedal (p. 56).

Display is faint or flickering

Check the following settings.

"Adjusting the LCD Contrast" (p. 46)

"Reducing Battery Consumption (Economy Mode)" (p. 46)

"Switching How the Pedal Indicators Light" (p. 51)

MEMO

The batteries that are supplied with the unit is for temporary use, intended primarily for testing this unit.

MEMO

When running on power supplied by an RRC2 IN device, the power is switched on regardless of the position of the POWER switch.

MEMO

Although the FC-300's EXP pedals are adjusted for optimal performance when shipped from the factory, extended use over time and under certain usage conditions may result in the pedals going out of adjustment.

MIDI Implementation

Roland System Exclusive Messages

1. Data Format for Exclusive Messages

Roland's MIDI implementation uses the following data format for all Exclusive messages (type IV):

Byte	Description
F0H	System Exclusive Status
41H	Manufacturer ID (Roland)
DEV	Device ID
MDL	Model ID
CMD	Command ID
[BODY]	Main data
F7H	EOX (End of System Exclusive)

MIDI status: F0H, F7H

An Exclusive message must be flanked by a pair of status codes, starting with a Manufacturer ID immediately after F0H (MIDI version 1.0).

Manufacturer ID: 41H

The Manufacturer ID identifies the manufacturer of a MIDI instrument that sends an System Exclusive message. Value 41H represents Roland's Manufacturer ID.

Device ID: DEV

The Device ID contains a unique value that identifies individual devices in the implementation of several MIDI instruments.

It is usually set to 00H-0FH, a value smaller by one than that of a basic channel, but value 00H-1FH may be used for a device with several basic channels.

Model ID: MDL

The Model ID contains a value that identifies one model from another. Different models, however, may share an identical Model ID if they handle similar data.

The Model ID format may contain 00H in one or more places to provide an extended data field.

The following are examples of valid Model IDs, each representing a unique model:

01H
02H
03H
00H, 01H
00H, 02H
00H, 00H, 01H

Command ID: CMD

The Command ID indicates the function of an Exclusive message.

The Command ID format may contain 00H in one or more places to provide an extended data field.

The following are examples of valid Command IDs, each representing a unique function:

01H
02H
03H
00H, 01H
00H, 02H
00H, 00H, 01H

Main data: BODY

This field contains a message to be exchanged across an interface.

The exact data size and content will vary with the Model ID and Command ID.

2. Address-mapped Data Transfer

Address mapping is a technique for transferring messages conforming to the data format given in Section 1.

It assigns a series of memory-resident records—waveform and tone data, switch status, and parameters, for example, to specific locations in a machine-dependent address space, thereby allowing access to data residing at the address a message specifies.

Address-mapped data transfer is therefore independent of models and data categories.

This technique allows use of two different transfer procedures: one-way transfer and handshake transfer.

One-way transfer procedure (See Section 3 for details.)

This procedure is suited to the transfer of a small amount of data.

It sends out an Exclusive message completely independent of the receiving device's status.

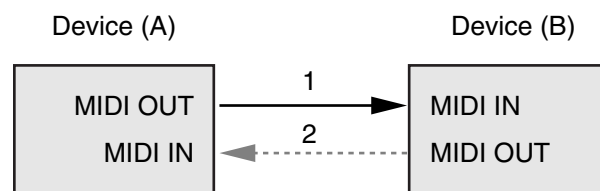

Connection at point 2 is essential for "Request data" procedures. (See Section 3.)

Handshake-transfer procedure (This device does not use this procedure)

This procedure initiates a predetermined transfer sequence (handshaking) across the interface before data transfer takes place. Handshaking ensures that reliability and transfer speed are high enough to handle a large amount of data.

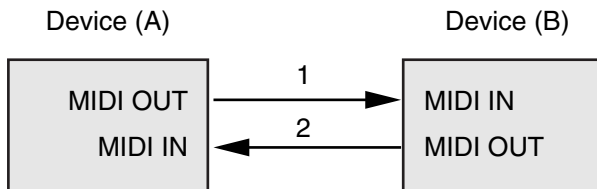

Connection at points 1 and 2 is essential.

MEMO

Notes on the above procedures

- There are separate Command IDs for different transfer procedures.
- Devices A and B cannot exchange data unless they use the same transfer procedure, share identical Device ID and Model ID, and are ready for communication.

3. One-way Transfer Procedure

This procedure sends out data until it has all been sent and is used when the messages are so short that answerbacks need not be checked.

For longer messages, however, the receiving device must acquire each message in time with the transfer sequence, which inserts 20 milliseconds intervals. In this method, as for the receiving device, it is necessary to receive data correctly in time.

Types of Messages

Message	Command ID
Request data 1	RQ1 (11H)
Data set 1	DT1 (12H)

Request data 1: RQ1 (11H)

This message is sent out when there is a need to acquire data from a device at the other end of the interface.

It contains data for the address and size that specify designation and length, respectively, of data required.

On receiving an RQ1 message, the remote device checks its memory for the data address and size that satisfy the request.

If it finds them and is ready for communication, the device will transmit a "Data set 1 (DT1)" message, which contains the requested data.

Otherwise, the device won't send out anything.

Byte	Description
F0H	System Exclusive Status
41H	Manufacturer ID (Roland)
DEV	Device ID
MDL	Model ID
11H	Command ID
aaH	Address MSB
:	:
:	:
	Address LSB
ssH	Size MSB
:	:
:	:
	Size LSB
sum	Check sum
F7H	EOX (End of System Exclusive)

MEMO

- The size of the requested data does not indicate the number of bytes that will make up a DT1 message, but represents the address fields where the requested data resides.
- Some models are subject to limitations in data format used for a single transaction. Requested data, for example, may have a limit in length or must be divided into predetermined address fields before it is exchanged across the interface.
- The same number of bytes comprises address and size data, which, however, vary with the Model ID.
- The error-checking process uses a checksum that provides a bit pattern where the last 7 bits are zero when values for an

address, size, and that checksum are summed.

Data set 1: DT1 (12H)

This message corresponds to the actual data transfer process.

Because every byte in the data is assigned a unique address, a DT1 message can convey the starting address of one or more bits of data as well as a series of data formatted in an address-dependent order.

The MIDI standards inhibit non real-time messages from interrupting an Exclusive one. This fact is inconvenient for devices that support a "soft-thru" function.

To maintain compatibility with such devices, Roland has limited the DT1 to 256 bytes so that an excessively long message is sent out in separate 'segments.'

Byte	Description
F0H	System Exclusive Status
41H	Manufacturer ID (Roland)
DEV	Device ID
MDL	Model ID
12H	Command ID
aaH	Address MSB
:	:
:	:
	Address LSB
ddH	Data MSB
:	:
:	:
	Data LSB
sum	Check sum
F7H	EOX (End of System Exclusive)

MEMO

- A DT1 message is capable of providing only the valid data among those specified by an RQ1 message.
- Some models are subject to limitations in data format used for a single transaction. Requested data, or example, may have a limit in length or must be divided into predetermined address fields before it is exchanged across the interface.
- The number of bytes comprising address data varies from one Model ID to another.
- The error-checking process uses a checksum that provides a bit pattern where the last 7 bits are zero when values for an address, data, and that checksum are summed.

Example of Message Transactions

- Device A sending data to Device B
Transfer of a DT1 message is all that takes place.

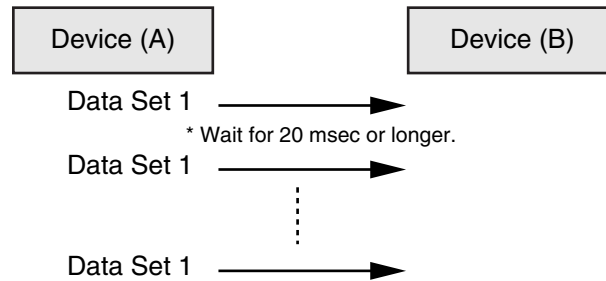

- Device B requesting data from Device A
Device B sends an RQ1 message to Device A. Checking the message, Device A sends a DT1 message back to Device

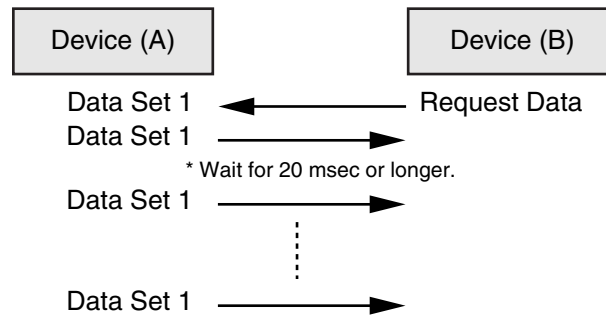

1. Recognized Receive Data

System Realtime Message

Active Sensing

Status
FEH

When FC-300 receives Active Sensing, it measures time intervals between incoming messages. If the subsequent message will not come within 400 msec after the previous one, FC-300 turns off Active Sensing for a period and stops measuring message intervals.

System Exclusive Message

Status	Data	Status
F0H	iiH, ddH,, eeH	F7H

Status	Data
F0H	System Exclusive Status
ii	ID Number: The ID Number (manufacturer's ID) is used to distinguish one manufacturer's System Exclusive messages from another. Roland's manufacturer ID is 41H. ID Numbers 7EH and 7FH are used as Universal Non-realtime messages (7EH), and Universal Realtime message (7FH) for extending the MIDI standard.
dd, ..., ee	00H-7FH (0-127)
F7H	EOX (End of System Exclusive)

System Exclusive messages that the FC-300 can receive are Data Request (RQ1) and Data Set (DT1).

For a detailed explanation about Data Request (RQ1) and Data Set (DT1), refer to "Roland System Exclusive Messages" (p. 59) and "3. Exclusive Communications" (p. 64).

2. Transmitted Data

Transmitted Messages

Channel Voice Message

Note Off

Status	Second	Third
8nH	kkH	vvH

n = MIDI Channel Number	0H-FH (ch.1-ch.16)
kk = Note Number	00H-7FH (0-127)
vv = Velocity	00H-7FH (0-127)

* Specifically when Patch Mode is selected.

Note On

Status	Second	Third
9nH	kkH	vvH

n = MIDI Channel Number	0H - FH (ch.1-ch.16)
kk = Note Number	00H-7FH (0-127)
vv = Velocity	01H-7FH (1-127)

* Specifically when Patch Mode is selected.

Polyphonic Key Pressure

Status	Second	Third
AnH	kkH	vvH

n = MIDI Channel Number	0H - FH (ch.1-ch.16)
kk = Note Number	00H-7FH (0-127)
vv = Polyphonic Key Pressure	00H-7FH (0-127)

* Specifically when Patch Mode is selected.

Control Change

Status	Second	Third
BnH	ccH	vvH

n = MIDI Channel Number	0H-FH (ch.1-ch.16)
cc = Control Number	01H-1FH (1-31), 21H-5FH (33-95)
vv = Control Value	00H-7FH (0-127)

* Does not transmit while in System Exclusive Mode.

Bank Select

Status	Second	Third
BnH	00H	mmH
BnH	20H	llH

n = MIDI Channel Number	0H-FH (ch.1-ch.16)
mm = Upper bytes of Bank Select Number	00H-7FH (0-127)
ll = Lower bytes of Bank Select Number	00H-7FH (0-127)

* Specifically when Standard Mode and Patch Mode are selected.

Program Change

Status	Second
CnH	ppH

n = MIDI Channel Number	0H-FH (ch.1-ch.16)
pp = Program Number	00H-7FH (prog.1-prog.128)

* Specifically when Standard Mode and Patch Mode are selected.

Channel Pressure

Status	Second
DnH	vvH

n = MIDI Channel Number	0H - FH (ch.1-ch.16)
vv = Channel Pressure	00H-7FH (0-127)

* Does not transmit while in System Exclusive Mode.

Pitch Bend Change

Status	Second	Third
EnH	llH	mmH

n = MIDI Channel Number	0H - FH (ch.1-ch.16)
mm, ll = Pitch Bend	00 00H - 40 00H - 7F 7FH (-8192 - 0 - +8192)

* Does not transmit while in System Exclusive Mode.

System Realtime Message

Start

Status
FAH

* Does not transmit while in System Exclusive Mode.

Continue

Status
FBH

* Does not transmit while in System Exclusive Mode.

Stop

Status
FCH

* Does not transmit while in System Exclusive Mode.

Active Sensing

Status
FEH

* During the normal operation, transmits at approx. 200 msec intervals.

* When message intervals are being monitored at the input section, the output of Active Sensing messages will cease for a certain period of time if the input interval exceeds 400 msec.

System Exclusive Message

Status	Data	Status
F0H	iiH, ddH,, eeH	F7H

F0H	System Exclusive Status
ii = ID Number	41H (65)
dd, ..., ee = data	00H-7FH (0-127)
F7H	EOX (End of System Exclusive)

For a detailed explanation, see "Roland System Exclusive Messages" (p. 59) and "3. Exclusive Communications" (p. 64).

MIDI Machine Control (MMC)

Status	Data	Status
F0H	7FH, 7FH, 06H, com	F7H

Byte	Description
F0H	System Exclusive Status
7FH	ID Number (Universal Realtime Message)
7FH	Device ID (Broadcast)
06H	Sub-ID#1 (Machine Control Command)
com	Sub-ID#2 (MMC Command)
F7H	EOX (End of System Exclusive)

* FC-300 can set the following MMC commands.

com	
01H	STOP
02H	PLAY
03H	DEFERRED PLAY
04H	FAST FORWARD
05H	REWIND
06H	RECORD STROBE
07H	RECORD EXIT
08H	RECORD PAUSE
09H	PAUSE

* Does not transmit while in System Exclusive Mode.

3. Exclusive Communications

Using Roland's one-way System Exclusive message you can transfer data between FC-300 and another device.

You can use the following Model ID for the FC-300.

- 00H 00H 1EH (FC-300)
You can use System Exclusive messages to transmit and receive the FC-300's internal parameters in the form of bulk data.
- 00H 00H 20H (Foot Controller)
You can use System Exclusive messages to transmit and receive the FC-300's operational messages and display messages.
The Device ID can be set within the 00H to 1FH range.

For more on setting the Device ID, see "Setting the Device ID" (p. 52).

Request Data 1 RQ1 (11H)

Byte	Description
F0H	System Exclusive Status
41H	Manufacturer ID (Roland)
dev	Device ID (dev: 00H-0FH)
mdl	Model ID (mdl: 00H 00H 1EH) FC-300 (mdl: 00H 00H 20H) Foot Controller
11H	Command ID (RQ1)
aaH	Address MSB
bbH	Address LSB
ssH	Size MSB
ttH	Size LSB
sum	Checksum
F7H	EOX (End of System Exclusive)

DATA SET 1 DT1 (12H)

Byte	Description
F0H	System Exclusive Status
41H	Manufacturer ID (Roland)
dev	Device ID (dev: 00H-0FH)
mdl	Model ID (mdl: 00H 00H 1EH) FC-300 (mdl: 00H 00H 20H) Foot Controller
12H	Command ID (DT1)
aaH	Address MSB
bbH	Address LSB
ddH	Data
:	:
eeH	Data
sum	Checksum
F7H	EOX (End of System Exclusive)

4. Parameter Address Map (Model ID = 00H 00H 20H)

There are two type of the FC-300 System Exclusive message. FC-300 can send and receive the operation of this unit and display information by using the system exclusive message.

Address Block Map

Address (H)	Block	Description
10 00	Mode Status	Read/Write
20 00	Pedal Status	Read
30 00	Pedal LED Status	Write
40 00	BANK/NUMBER Display Status	Write
50 00	Controller Status	Read/Write
60 00	Message Display Status	Write
68 00	Message Display User Font	Write
70 00	Tuner Display Status	Write
71 00	Tuner Pitch Status	Write

Mode Status (Individual area)

Address (H)	Size (H)	Data (H)	Parameter	Description
10 00	00 01	00-01	SYSEX Mode Status *1	0: Off, 1:On
10 01	00 01	00-01	SYSEX Mode Status *2	0: Off, 1:On
10 02	00 01	00-01	Function Mode Status *3	0: Play, 1:TUNER

*1 Outputs on power-up or when Mode change is made.

Also outputs upon receiving Data Request (RQ1).

Data Set (DT1) is ignored.

*2 Mode Status is changed when Data Set (DT1) is received.

Changes the System Exclusive Mode when On is received.

MODE pedal is pressed same operation when Off is received in System Exclusive Mode.

*3 Changes the display of LCD in System Exclusive Mode when Data Set (DT1) is received.

Appears the received data in Message Display Status Address when PLAY is received.

Appears the TUNER screen and received data in Tuner Pitch Status Address when TUNER is received. (FC-300 has not TUNER function.)

Outputs when Data Request (RQ1) is received.

Pedal Status (Individual area)

Address (H)	Size (H)	Data (H)	Parameter	Description
20 00	00 01	00/7F	Pedal 1/6 Status	OFF/ON
20 01	00 01	00/7F	Pedal 2/7 Status	OFF/ON
20 02	00 01	00/7F	Pedal 3/8 Status	OFF/ON
20 03	00 01	00/7F	Pedal 4/9 Status	OFF/ON
20 04	00 01	00/7F	Pedal 5/10 Status	OFF/ON
21 00	00 01	00/7F	CTL Pedal 1 Status	OFF/ON
21 01	00 01	00/7F	CTL Pedal 2 Status	OFF/ON
21 02	00 01	00/7F	CTL Pedal 4 Status	OFF/ON
21 03	00 01	00/7F	CTL Pedal 6 Status	OFF/ON
21 04	00 01	00/7F	CTL Pedal 8 Status	OFF/ON
22 00	00 01	00/7F	EXP Pedal SW 1 Status	OFF/ON
22 01	00 01	00/7F	EXP Pedal SW 2 Status	OFF/ON
24 00	00 01	00-7F	EXP Pedal 1 Status	0-127
24 01	00 01	00-7F	EXP Pedal 2 Status	0-127
24 02	00 01	00-7F	CTL3/EXP3 Pedal Status	0-127
24 03	00 01	00-7F	CTL5/EXP4 Pedal Status	0-127
24 04	00 01	00-7F	CTL7/EXP5 Pedal Status	0-127
25 00	00 01	00/7F	UP Pedal Status	OFF/ON
25 01	00 01	00/7F	DOWN Pedal Status	OFF/ON

- Outputs when pedal is operated while in the System Exclusive Mode.
- Also outputs Data Set (DT1) when Data Request (RQ1) is received.
- Data Set (DT1) is ignored.

LED Status (Individual area)

Address (H)	Size (H)	Data (H)	Parameter	Description
30 00	00 01	00/7F	Pedal 1/6 red LED Status	OFF/ON
30 01	00 01	00/7F	Pedal 2/7 red LED Status	OFF/ON
30 02	00 01	00/7F	Pedal 3/8 red LED Status	OFF/ON
30 03	00 01	00/7F	Pedal 4/9 red LED Status	OFF/ON
30 04	00 01	00/7F	Pedal 5/10 red LED Status	OFF/ON
30 05	00 01	00/7F	Pedal 1/6 green LED Status	OFF/ON
30 06	00 01	00/7F	Pedal 2/7 green LED Status	OFF/ON
30 07	00 01	00/7F	Pedal 3/8 green LED Status	OFF/ON
30 08	00 01	00/7F	Pedal 4/9 green LED Status	OFF/ON
30 09	00 01	00/7F	Pedal 5/10 green LED Status	OFF/ON
31 00	00 01	00/7F	CTL Pedal 1 LED Status	OFF/ON
31 01	00 01	00/7F	CTL Pedal 2 LED Status	OFF/ON
32 00	00 01	00/7F	EXP Pedal SW 1 LED Status	OFF/ON
32 01	00 01	00/7F	EXP Pedal SW 2 LED Status	OFF/ON
35 00	00 01	00/7F	UP Pedal LED Status	OFF/ON
35 01	00 01	00/7F	DOWN Pedal LED Status	OFF/ON

- Receives Data Set (DT1) in all mode, changes the LED status of each pedal only in the System Exclusive Mode.
- Data Request (RQ1) is ignored.

BANK/NUMBER Display Status (Individual area)

Address (H)	Size (H)	Data (H)	Parameter	Description
40 00	00 02	0abcdefg, 0000000h	Right	
40 02	00 02	0abcdefg, 0000000h	Center	
40 04	00 02	0abcdefg, 0000000h	Left	

- Receives Data Set (DT1) in all mode, changes the BANK/NUMBER display status only in the System Exclusive Mode.
- Each bit represents ON/OFF of corresponding display segment. Bit "0" = OFF; "1" = ON
- Data Request (RQ1) is ignored.

MIDI Implementation

Controller Status (Individual area)

Address (H)	Size (H)	Data (H)	Parameter	Description
50 00	00 01	00/7F	AMP CONTROL 1 Status	OFF/ON
50 01	00 01	00/7F	AMP CONTROL 2 Status	OFF/ON

- Receives Data Set (DT1) in all mode.
- Changes status of AMP CONTROL jack when Data Set (DT1) is received.
- Outputs when Data Request (RQ1) is received.

Message Display Status (Individual area)

Address (H)	Size (H)	Data (H)	Parameter	Description
60 00	00 10	00-07, 20-7D	Line 0 Column 0 data	00-07: User Font 20-7D: ASCII characters
:		:	:	
60 0F	00-07, 20-7D	Line 0 Column 15 data		
:	:	:		
64 00	00 10	00-07, 20-7D	Line 1 Column 0 data	
:		:	:	
64 0F	00-07, 20-7D	Line 1 Column 15 data		
:	:	:		

- Receives Data Set (DT1) in all mode.
- Outputs when Data Request (RQ1) is received.

Message Display User Font (Individual area)

Address (H)	Size (H)	Data (H)	Parameter	Description
68 00	00 08	00-1F	User Font 1 Line 0 data	*1
:		:	:	
68 07	00-1F	User Font 1 Line 7 data		
:	:	:		
68 08	00 08	00-1F	User Font 2 Line 0 data	
:		:	:	
68 38	00 08	00-1F	User Font 8 Line 7 data	
:	:	:		

- Receives Data Set (DT1) in all mode, changes the user font of the LCD only in the System Exclusive Mode.
- Data Request (RQ1) is ignored.

*1 The bitmap data of the user font following displayed in LCD.

Parameter	Data
User Font line0 data	000xxxxx
User Font line1 data	000xxxxx
User Font line2 data	000xxxxx
User Font line3 data	000xxxxx
User Font line4 data	000xxxxx
User Font line5 data	000xxxxx
User Font line6 data	000xxxxx
User Font line7 data	000xxxxx

Tuner Display Status (Individual area)

Address (H)	Size (H)	Data (H)	Parameter	Description
70 01	00 01	00/7F	C#/D ^b Display Status	C#/D ^b
70 02	00 01	00/7F	D#/E ^b Display Status	D#/E ^b
70 03	00 01	00/7F	F#/G ^b Display Status	F#/G ^b
70 04	00 01	00/7F	G#/A ^b Display Status	G#/A ^b
70 05	00 01	00/7F	A#/B ^b Display Status	A#/B ^b

- Receives Data Set (DT1) in all mode, changes the display of the LCD when only Function Mode Status is TUNER.
- Data Request (RQ1) is ignored.

Tuner Pitch Status (Individual area)

Address (H)	Size (H)	Data (H)	Parameter	Description
71 00	00 01	00, 01-06	String Number	00: OFF 01: 1-6
71 01	00 01	00, 01-0D	Tuner Note Status	00: No Signal 01: C, 02: C# 03: D, 04: D# 05: E, 06: F 07: F#, 08: G 09: G#, 0A: A 0B: A#, 0C: B
71 02	00 01	00, 01-40-7F	Tuner Cent Status	00: No Signal 01: -50 40: 0 7F: 50

- Receives Data Set (DT1) when only Function Mode Status is TUNER.
- Changes the display of the LCD when Data Set (DT1) is received.
- Data Request (RQ1) is ignored.

MIDI FOOT CONTROLLER
Model FC-300

Date : Apr. 1, 2007
Version : 1.00

MIDI Implementation Chart

Function...	Transmitted	Recognized	Remarks	
Basic Channel	Default 1-16 Changed 1-16	*1 x *1 x	Memorized	
Mode	Default Messages Altered *****	x x		
Note Number	True Voice 0-127 *****	*3 x x		
Velocity	Note ON Note OFF	o 9n v=1-127 *3 o 8n v=0-127 *3	x x	
After Touch	Key's Ch's	o 0-127 *3 o 1-16 *1	x x	
Pitch Bend		o *1	x	
Control Change	0, 32 1 - 31 33 - 95	o *2 o *1 o *1	x x x	Bank Select
Program Change	True #	o *2 *****	x x	Program Number 1 - 128
System Exclusive		o	o	
Common	Song Position Song Select Tune Request	x x x	x x x	
System Realtime	Clock Commands	x o *1	x x	
AUX Messages	Local ON/OFF All Notes OFF All Sound OFF Reset All Controller Active Sense System Reset	x x x x o x	x x x x o x	
Notes	*1 Does not transmit while in System Exclusive Mode. *2 Transmits while in Standard Mode and Patch Mode. *3 Transmits while in Patch Mode.			

Mode 1: OMNI ON, POLY
Mode 3: OMNI OFF, POLY

Mode 2: OMNI ON, MONO
Mode 4: OMNI OFF, MONO

o: Yes
x: No

Specifications

FC-300 : MIDI FOOT CONTROLLER

Connectors	MIDI connectors (IN, OUT)
	MODE jack
	EXP PEDAL/CTL jack (3/3,4 4/5,6 5/7,8)
	AMP CONTROL jack (1, 2)
	RRC2 OUT connector
	DC IN jack
Controls	Number pedals 1/6-5/10
	[▼] [▲] pedals
	CTL pedals (1, 2)
	EXP PEDAL (1, 2)
	PARAMETER [◀] [▶] button
	VALUE [▼] [▲] button
	UTILITY button
	MODE button
	EXIT button
	WRITE button
	POWER switch
Display	BANK/NUMBER display (7 segments w/ dots, 3 characters LED)
	LCD (16 characters x 2 lines with backlit)
Indicators	MODE indicators (STANDARD, CONTROL, SYS EX, PATCH)
	UTILITY button indicator
	WRITE button indicator
	Number pedal indicators 1/6-5/10 (When the number pedal 1-5 is selected, the indicator lights in red. When the number pedal 6-10 is selected, the indicator lights in green.)
	[▼] [▲] pedal indicators
	CTL pedal indicators (1, 2)
	EXP PEDAL indicators (1, 2)
Number of Patches (Patch Mode)	100
Power Supply	9 V DC: Dry battery (AA) type x 6
	AC Adaptor (BOSS PSA series; sold separately)
	RRC2 (Supplied from RRC2 IN device)
Current Draw	94 mA (When Economy Mode is OFF.)
	61 mA (When Economy Mode is ON.)
Expected battery life under continuous use (Carbon):	6.5 hours or longer (When Economy Mode is OFF)
	12 hours or longer (When Economy Mode is ON) * These figures will vary depending on the actual conditions of use.
Dimensions	550 (W) x 250 (D) x 76 (H) mm
	21-11/16 (W) x 9-7/8 (D) x 3 (H) inches
Weight	5.3 kg / 11 lbs 11 oz (including batteries)
Accessories	Owner's Manual
	Dry battery R6 (AA) type (carbon) x 6
	Roland Service
Options	AC Adaptor: BOSS PSA series
	Footswitch: BOSS FS-5U, FS-6
	Expression Pedal: Roland EV-5, BOSS FV-500L, FV-500H

* In the interest of product development, the specifications and/or appearance of this unit are subject to change without prior notice.

Index

Numerics

- 1/6 – 5/10 pedals 9
- 1/6–5/10 21

A

- AMP 1 Pol. 50
- AMP 2 Pol. 50
- AMP CONTROL 1, 2 jack 10
- AMP CTL OP 20, 43
- AMP Ctl Op 25
- Assign Number 42

B

- Bank Display 49
- Bank Extent 48
- Bank Select 53
- Bank Step 49
- BANK/NUMBER display 7
- Battery Low! 57
- Bnk Chg Mode 48
- Bnk Sel Out 52
- Bulk Dump 53
- Bulk Load 54

C

- Contrast 46
- Control Change Mode 14, 21
- Copy MIDI Streams 39
- CTL pedals 9

D

- DC IN (AC Adaptor) jack 10
- DEL button 8
- Delete MIDI Streams 40
- Deleting Patches 45
- Device ID 52

E

- E3/C3 Type 50
- E4/C5 Type 50
- E5/C7 Type 50
- Economy Mode 46
- Error Messages 57
- EXIT button 8
- EXP PEDAL 1, 2 9
- EXP PEDAL SW 1, 2 9
- EXP PEDAL SW indicators 9
- EXP PEDAL/CTL jack 10

F

- Factory Reset 55

I

- INS button 8

L

- LCD 7
- LCD Contrast 46
- Liquid Crystal display 7

M

- Memory Full! 57
- MIDI Buffer Full! 57
- MIDI Channel 42
- MIDI connectors (OUT, IN) 10
- MIDI Offline! 57
- Mode 20, 25, 43
- MODE button 8
- MODE indicator 7
- MODE jack 10
- MODE Pdl Seq 51
- MODES 14

N

- Number Pedal 9, 21

P

- PARAMETER button 8
- Patch Mode 14, 29
- Patch Name 44
- PC Mode 47
- Pdl Indicate 51
- Pedal Settings 19, 24, 26, 42
- Pedal Step Size 49
- Polarity 50
- POWER switch 10

R

- Range 20, 25, 43
- RRC2 Buffer Full! 57
- RRC2 connecting cable 12
- RRC2 Offline! 57
- RRC2 OUT connector 10

S

- Set to MAX 56
- Set to MIN 56
- Standard Mode 14, 16
- Storing (Saving) Patches 44

Index

System Exclusive Messages	59
System Exclusive Mode	14
System Parameters	46

T

Threshold	56
Troubleshooting	58
Tx Channel	52

U

UTILITY button	8
----------------------	---

V

VALUE button	8
--------------------	---

W

WRITE button	8
--------------------	---

For the U.K.

IMPORTANT: THE WIRES IN THIS MAINS LEAD ARE COLOURED IN ACCORDANCE WITH THE FOLLOWING CODE.

BLUE: NEUTRAL
BROWN: LIVE

As the colours of the wires in the mains lead of this apparatus may not correspond with the coloured markings identifying the terminals in your plug, proceed as follows:
The wire which is coloured BLUE must be connected to the terminal which is marked with the letter N or coloured BLACK.
The wire which is coloured BROWN must be connected to the terminal which is marked with the letter L or coloured RED.
Under no circumstances must either of the above wires be connected to the earth terminal of a three pin plug.

For EU Countries



This product complies with the requirements of European Directive 89/336/EEC.

For the USA

FEDERAL COMMUNICATIONS COMMISSION RADIO FREQUENCY INTERFERENCE STATEMENT

This equipment has been tested and found to comply with the limits for a Class B digital device, pursuant to Part 15 of the FCC Rules. These limits are designed to provide reasonable protection against harmful interference in a residential installation. This equipment generates, uses, and can radiate radio frequency energy and, if not installed and used in accordance with the instructions, may cause harmful interference to radio communications. However, there is no guarantee that interference will not occur in a particular installation. If this equipment does cause harmful interference to radio or television reception, which can be determined by turning the equipment off and on, the user is encouraged to try to correct the interference by one or more of the following measures:

- Reorient or relocate the receiving antenna.
- Increase the separation between the equipment and receiver.
- Connect the equipment into an outlet on a circuit different from that to which the receiver is connected.
- Consult the dealer or an experienced radio/TV technician for help.

This device complies with Part 15 of the FCC Rules. Operation is subject to the following two conditions:

- (1) this device may not cause harmful interference, and
- (2) this device must accept any interference received, including interference that may cause undesired operation.

Unauthorized changes or modification to this system can void the users authority to operate this equipment.
This equipment requires shielded interface cables in order to meet FCC class B Limit.

For Canada

NOTICE

This Class B digital apparatus meets all requirements of the Canadian Interference-Causing Equipment Regulations.

AVIS

Cet appareil numérique de la classe B respecte toutes les exigences du Règlement sur le matériel brouilleur du Canada.

Information

When you need repair service, call your nearest Roland Service Center or authorized Roland distributor in your country as shown below.

AFRICA

EGYPT

Al Fanny Trading Office
9, EBN Hagar A1 Askalani
Street,
ARD El Golf, Heliopolis,
Cairo 11341, EGYPT
TEL: 20-2-417-1828

REUNION

Maison FO - YAM Marcel
25 Rue Jules Hermann,
Chaudron - BP79 97 491
Ste Clotilde Cedex,
REUNION ISLAND
TEL: (0262) 218-429

SOUTH AFRICA

T.O.M.S. Sound & Music
(Pty)Ltd.
2 ASTRON ROAD DENVER
JOHANNESBURG ZA 2195,
SOUTH AFRICA
TEL: (011)417 3400
FAX: (011)417 3462

Paul Bothner(PTY)Ltd.
Royal Cape Park, Unit 24
Londonderry Road, Ottery 7800
Cape Town, SOUTH AFRICA
TEL: (021) 799 4900

ASIA

CHINA

Roland Shanghai Electronics
Co.,Ltd.
5F, No.1500 Pingliang Road
Shanghai 200090, CHINA
TEL: (021) 5580-0800

Roland Shanghai Electronics
Co.,Ltd.
(BEIJING OFFICE)
10F, No.183 Section Anhuaxili
Chaoyang District Beijing
100011 CHINA
TEL: (010) 6426-5050

HONG KONG

Tom Lee Music Co., Ltd.
Service Division
22-32 Pun Shan Street, Tsuen
Wan, New Territories,
HONG KONG
TEL: 2415 0911

Parsons Music Ltd.
8th Floor, Railway Plaza, 39
Chatham Road South, T.S.T,
Kowloon, HONG KONG
TEL: 2333 1863

INDIA

Rivera Digitech (India) Pvt. Ltd.
409, Nirman Kendra
Mahalaxmi Flats Compound
Off. Dr. Edwin Moses Road,
Mumbai-400011, INDIA
TEL: (022) 2493 9051

INDONESIA

PT Citra IntiRama
Jl. Cideng Timur No. 15J-150
Jakarta Pusat
INDONESIA
TEL: (021) 6324170

KOREA

Cosmos Corporation
1461-9, Seocho-Dong,
Seocho Ku, Seoul, KOREA
TEL: (02) 3486-8855

MALAYSIA

Roland Asia Pacific Sdn. Bhd.
45-1, Block C2, Jalan PJU 1/39,
Dataran Prima, 47301 Petaling
Jaya, Selangor, MALAYSIA
TEL: (03) 7805-3263

PHILIPPINES

G.A. Yupangco & Co. Inc.
339 Gil J. Puyat Avenue
Makati, Metro Manila 1200,
PHILIPPINES
TEL: (02) 899 9801

SINGAPORE

SWEET LEE MUSIC
COMPANY PTE. LTD.
150 Sims Drive,
SINGAPORE 387381
TEL: 6846-3676

TAIWAN

ROLAND TAIWAN
ENTERPRISE CO., LTD.
Room 5, 9fl. No. 112 Chung
Shan N.Road Sec.2, Taipei,
TAIWAN, R.O.C.
TEL: (02) 2561 3339

THAILAND

Theera Music Co., Ltd.
330 Soi Veng NakornKasem,
New Road, Sumpantawongse,
Bangkok 10100, THAILAND
TEL: (02) 224-8821

AUSTRALIA/ NEW ZEALAND

AUSTRALIA/ NEW ZEALAND

Roland Corporation
Australia Pty.,Ltd.
38 Campbell Avenue
Dee Why West. NSW 2099
AUSTRALIA

For Australia
Tel: (02) 9982 8266
For New Zealand
Tel: (09) 3098 715

CENTRAL/LATIN AMERICA

ARGENTINA

Instrumentos Musicales S.A.
Av.Santa Fe 2055
(1123) Buenos Aires
ARGENTINA
TEL: (011) 4508-2700

BARBADOS

A&B Music Supplies LTD
12 Webster Industrial Park
Wildey, St.Michael, Barbados
TEL: (246)430-1100

BRAZIL

Roland Brasil Ltda.
Rua San Jose, 780 Sala B
Parque Industrial San Jose
Cotia - Sao Paulo - SP, BRAZIL
TEL: (011) 4615 5666

CHILE

Comercial Fancy II S.A.
Rut: 96.919.420-1
Natanuel Cox #739, 4th Floor
Santiago - Centro, CHILE
TEL: (02) 688-9540

COLOMBIA

Centro Musical Ltda.
Cra 43 B No 25 A 41 Bododega 9
Medellin, Colombia
TEL: (574)3812529

COSTA RICA

JUAN Bansbach Instrumentos
Musicales
Ave.1. Calle 11, Apartado
10237,
San Jose, COSTA RICA
TEL: 258-0211

CURACAO

Zeelandia Music Center Inc.
Orionweg 30
Curacao, Netherland Antilles
TEL: (305)5926866

DOMINICAN REPUBLIC

Instrumentos Fernando Giraldez
Calle Proyecto Central No.3
Ens.La Esperilla
Santo Domingo,
Dominican Republic
TEL:(809) 683 0305

ECUADOR

Mas Musica
Rumichaca 822 y Zaruma
Guayaquil - Ecuador
TEL:(593-4)2302364

EL SALVADOR

OMNI MUSIC
75 Avenida Norte y Final
Alameda Juan Pablo II,
Edificio No.4010 San Salvador,
EL SALVADOR
TEL: 262-0788

GUATEMALA

Casa Instrumental
Calzada Roosevelt 34-01,zona 11
Ciudad de Guatemala
Guatemala
TEL:(502) 599-2888

HONDURAS

Almacen Pajaro Azul S.A. de C.V.
B.O.Paz Barahona
3 Ave.11 Calle S.O
San Pedro Sula, Honduras
TEL: (504) 553-2029

MARTINIQUE

Musique & Son
Z.I.Les Mangle
97232 Le Lamantin
Martinique F.W.I.
TEL: 596 596 426860

Gigamusik SARL
10 Rte De La Folie
97200 Fort De France
Martinique F.W.I.
TEL: 596 596 715222

MEXICO

Casa Veerkamp, s.a. de c.v.
Av. Toluca No. 323, Col. Olivar
de los Padres 01780 Mexico
D.F. MEXICO
TEL: (55) 5668-6699

NICARAGUA

Bansbach Instrumentos
Musicales Nicaragua
Altamira D'Este Calle Principal
de la Farmacia 5ta.Avenida
1 Cuadra al Lago.#503
Managua, Nicaragua
TEL: (505)277-2557

PANAMA

SUPRO MUNDIAL, S.A.
Boulevard Andrews, Albrook,
Panama City, REP. DE
PANAMA
TEL: 315-0101

PARAGUAY

Distribuidora De
Instrumentos Musicales
J.E. Olear y ESQ. Manduvira
Asuncion PARAGUAY
TEL: (595) 21 492147

PERU

Audionet
Distribuciones Musicales SAC
Juan Fanning 530
Miraflores
Lima - Peru
TEL: (511) 4461388

TRINIDAD

AMR Ltd
Ground Floor
Maritime Plaza
Barataria Trinidad W.I.
TEL: (868) 638 6385

URUGUAY

Todo Musica S.A.
Francisco Acuna de Figueroa
1771
C.P.: 11.800
Montevideo, URUGUAY
TEL: (02) 924-2335

VENEZUELA

Instrumentos Musicales
Allegro,C.A.
Av.las industrias edf.Guitar
import
#7 zona Industrial de Turumo
Caracas, Venezuela
TEL: (212) 244-1122

EUROPE

AUSTRIA

Roland Elektronische
Musikinstrumente HmbH.
Austrian Office
Eduard-Bodem-Gasse 8,
A-6020 Innsbruck, AUSTRIA
TEL: (0512) 26 44 260

BELGIUM/FRANCE/ HOLLAND/ LUXEMBOURG

Roland Central Europe N.V.
Houtstraat 3, B-2260, Oevel
(Westerlo) BELGIUM
TEL: (014) 575811

CROATIA

ART-CENTAR
Degenova 3,
HR - 10000 Zagreb
TEL: (1) 466 8493

CZECH REP.

CZECH REPUBLIC
DISTRIBUTOR s.r.o
Votárova 247/16
CZ - 180 00 PRAHA 8,
CZECH REP.
TEL: (2) 830 20270

DENMARK

Roland Scandinavia A/S
Nordhavnsvej 7, Postbox 880,
DK-2100 Copenhagen
DENMARK
TEL: 3916 6200

FINLAND

Roland Scandinavia As, Filial
Finland
Elannontie 5
FIN-01510 Vantaa, FINLAND
TEL: (019) 68 24 020

GERMANY

Roland Elektronische
Musikinstrumente HmbH.
Oststrasse 96, 22844
Norderstedt, GERMANY
TEL: (040) 52 60090

GREECE/CYPRUS

STOLLAS S.A.
Music Sound Light
155, New National Road
Patras 26442, GREECE
TEL: 2610 435400

HUNGARY

Roland East Europe Ltd.
Warehouse Area 'DEPO' Pf.83
H-2046 Torokbalint,
HUNGARY
TEL: (23) 511011

IRELAND

Roland Ireland
G2 Calmount Park, Calmount
Avenue, Dublin 12
Republic of IRELAND
TEL: (01) 4294444

ITALY

Roland Italy S. p. A.
Viale delle Industrie 8,
20020 Arese, Milano, ITALY
TEL: (02) 937-78300

NORWAY

Roland Scandinavia Avd.
Kontor Norge
Lilleakerveien 2 Postboks 95
Lilleaker N-0216 Oslo
NORWAY
TEL: 2273 0074

POLAND

ROLAND POLSKA SP. Z O.O.
UL. Gibrallarska 4.
PL-03 664 Warszawa
POLAND
TEL: (022) 679 4419

PORTUGAL

Roland Iberia, S.L.
Portugal Office
Cais das Pedras, 8/9-1 Dto
4050-465, Porto, PORTUGAL
TEL: 22 608 00 60

ROMANIA

FBS LINES
Piata Libertatii 1,
535500 Gheorgheni,
ROMANIA
TEL: (266) 364 609

RUSSIA

MuTek
Dorozhnaya ul.3,corp.6
117 545 Moscow, RUSSIA
TEL: (095) 981-4967

SLOVAKIA

DAN Acoustic s.r.o.
Povazská 18.
SK - 940 01 Nové Zámky
TEL: (035) 6424 330

SPAIN

Roland Iberia, S.L.
Paseo Garcia Faria, 33-35
08005 Barcelona SPAIN
TEL: 93 493 91 00

SWEDEN

Roland Scandinavia A/S
SWEDISH SALES OFFICE
Danvik Center 28, 2 tr.
S-131 30 Nacka SWEDEN
TEL: (0)8 702 00 20

SWITZERLAND

Roland (Switzerland) AG
Landstrasse 5, Postfach,
CH-4452 Itingen,
SWITZERLAND
TEL: (061) 927-8383

UKRAINE

EURHYTHMICS Ltd.
P.O.Box: 37-a.
Nedecey Str. 30
UA - 89600 Mukachevo,
UKRAINE
TEL: (03131) 414-40

UNITED KINGDOM

Roland (U.K.) Ltd.
Atlantic Close, Swansea
Enterprise Park, SWANSEA
SA7 9FJ,
UNITED KINGDOM
TEL: (01792) 702701

MIDDLE EAST

BAHRAIN

Moon Stores
No.16, Bab Al Bahrain Avenue,
P.O.Box 247, Manama 304,
State of BAHRAIN
TEL: 17 211 005

IRAN

MOCO INC.
No.41 Nike St., Dr.Shariyati Ave.,
Roberoye Cerahe Mirdamad
Tehran, IRAN
TEL: (021) 285-4169

ISRAEL

Halilit P. Greenspoon & Sons
Ltd.
8 Retzif Ha'aliya Hashnya St.
Tel-Aviv-Yafo ISRAEL
TEL: (03) 6823666

JORDAN

MUSIC HOUSE CO. LTD.
FREDDY FOR MUSIC
P. O. Box 922846
Amman 11192 JORDAN
TEL: (06) 5692696

KUWAIT

EASA HUSAIN AL-YOUSIFI
& SONS CO.
Abdullah Salem Street,
Safat, KUWAIT
TEL: 243-6399

LEBANON

Chahine S.A.L.
Gerge Zeidan St., Chahine
Bldg., Achrafieh, P.O.Box: 16-
5857
Beirut, LEBANON
TEL: (01) 20-1441

OMAN

TALENTZ CENTRE L.L.C.
Malatan House No.1
Al Noor Street, Ruwi
SULTANATE OF OMAN
TEL: 2478 3443

QATAR

Al Emadi Co. (Badie Studio &
Stores)
P.O. Box 62, Doha, QATAR
TEL: 4423-554

SAUDI ARABIA

aDawlah Universal
Electronics APL
Corniche Road, Aldossary
Bldg., 1st Floor, Alkhobar,
SAUDI ARABIA

P.O.Box 2154, Alkhobar 31952
SAUDI ARABIA
TEL: (03) 898 2081

SYRIA

Technical Light & Sound
Center
Rawda, Abdul Qader Zajzari St.
Bldg. No. 21, P.O.BOX 13520,
Damascus, SYRIA
TEL: (011) 223-5384

TURKEY

ZUHAL DIS TICARET A.S.
Galip Dede Cad. No.37
Beyoglu - Istanbul / TURKEY
TEL: (0212) 249 85 10

U.A.E.

Zak Electronics & Musical
Instruments Co. L.L.C.
Zabeel Road, Al Sherooq Bldg.,
No. 14, Grand Floor, Dubai,
U.A.E.
TEL: (04) 3360715

NORTH AMERICA

CANADA

Roland Canada Ltd.
(Head Office)
5480 Parkwood Way
Richmond B. C., V6V 2M4
CANADA
TEL: (604) 270 6626

Roland Canada Ltd.

(Toronto Office)
170 Admiral Boulevard
Mississauga ON L5T 2N6
CANADA
TEL: (905) 362 9707

U. S. A.

Roland Corporation U.S.
5100 S. Eastern Avenue
Los Angeles, CA 90040-2938,
U. S. A.
TEL: (323) 890 3700

As of November 1, 2006 (ROLAND)

Free Manuals Download Website

<http://myh66.com>

<http://usermanuals.us>

<http://www.somanuals.com>

<http://www.4manuals.cc>

<http://www.manual-lib.com>

<http://www.404manual.com>

<http://www.luxmanual.com>

<http://aubethermostatmanual.com>

Golf course search by state

<http://golfingnear.com>

Email search by domain

<http://emailbydomain.com>

Auto manuals search

<http://auto.somanuals.com>

TV manuals search

<http://tv.somanuals.com>