

CHORUS ECHO

RE-501

OWNER'S MANUAL

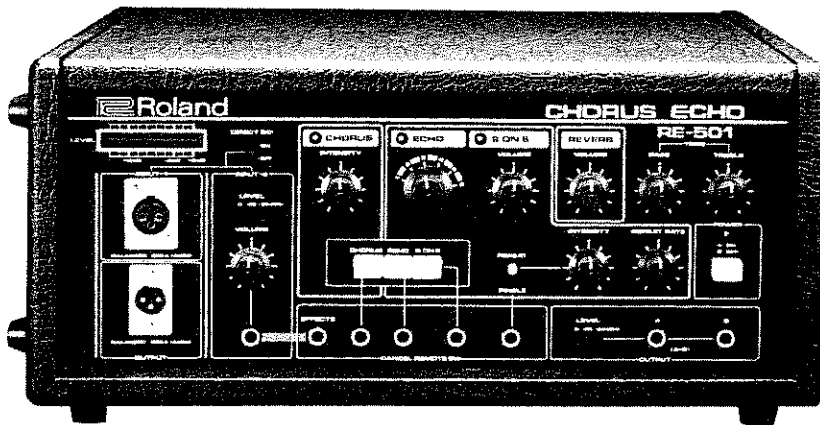

FEATURES

- ECHO, CHORUS, REVERBERATION, and SOUND-ON-SOUND can be freely combined for numerous effects.
- Free running tape system minimizes wow and flutter and extends tape life to more than 300 hours without deterioration of sound quality.
- Dual outputs for "three dimensional" sound effects.
- Low noise; clean well-balanced echo sound.
- Indicators show instantly whether echo, chorus, or sound-on-sound are ON or OFF.
- A foot switch can be used for switching ON/OFF the echo, chorus, and sound-on-sound.
- Both balanced and unbalanced input and output.

STANDARD CONNECTIONS

PA and Vocal Mixers

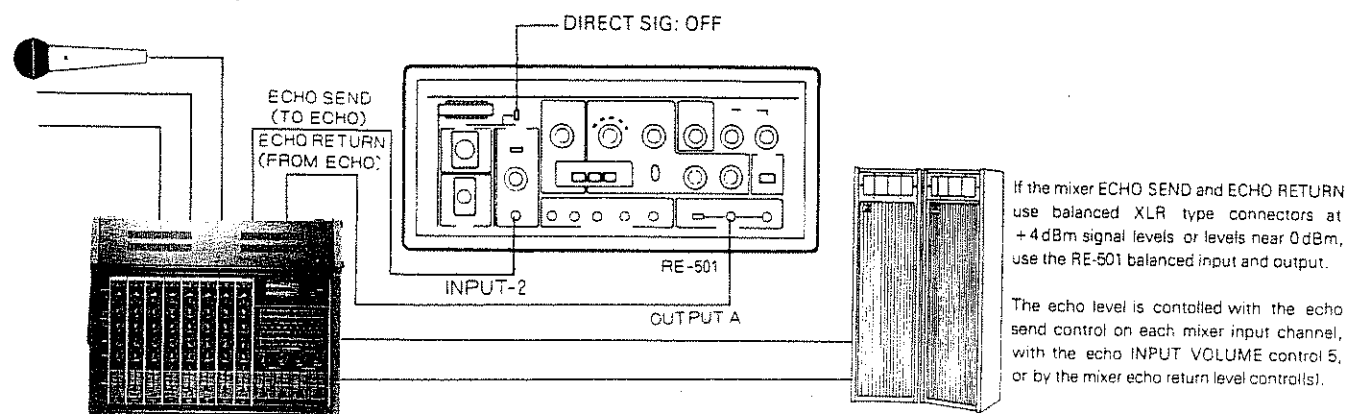

Microphones and Instruments

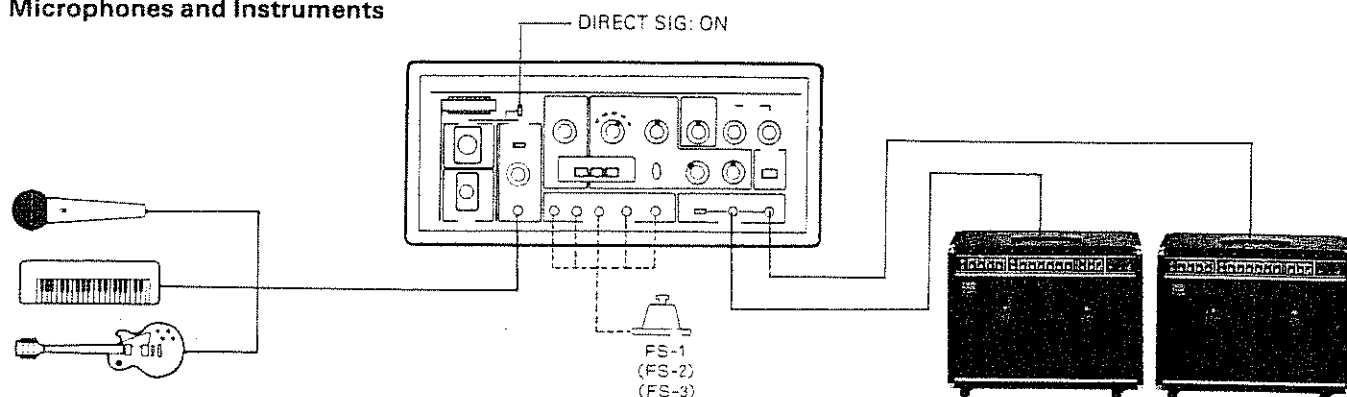

OPERATION

1. After making the connections, set the following controls at center (pointing straight up): CHORUS INTENSITY ④, ECHO/S ON S INTENSITY ⑩, ECHO/S ON S VOLUME ⑪, ECHO/S ON S REPEAT RATE ⑫, tone controls ⑬ ⑭. Set the INPUT VOLUME control ⑤ REVERB VOLUME ⑮ fully counter-clockwise.

2. When using the RE-501 with mixer echo send and return circuits, set the DIRECT SIGNAL switch ⑦ at OFF; for other situations, set at ON.

3. Set the INPUT LEVEL switch ⑥ as needed.

4. Set the OUTPUT LEVEL switch ⑯ as needed.

5. Turn the POWER switch ⑰ ON.

6. Turn up the INPUT VOLUME control ⑤. Set the CHORUS ④, ECHO ⑩, and S ON S EFFECT ⑫ switches at OFF (buttons in the raised positions).

7. Set the INPUT VOLUME control ⑤ so that the INPUT LEVEL INDICATOR ① reads an average of 0 dB when inputting sound.

NOTE: The INPUT VOLUME control ⑤ does not affect the balanced input.

USING THE CHORUS EFFECT

Set the controls at their normal positions as given previously.

1. Depress the CHORUS ON/OFF button ⑩ and note that the CHORUS indicator ③ lights.

2. Adjust the depth of the chorus effect with the chorus intensity control ④.

USING THE ECHO EFFECT

Set the controls at their normal positions as given previously.

1. Depress the ECHO ON/OFF button ⑫ and note that the ECHO indicator ① lights.

2. Adjust the depth of the echo effect with the ECHO/S ON S VOLUME control ⑪.

3. Set the ECHO MODE SELECTOR switch ⑬ for the desired echo pattern.

4. Set the ECHO/S ON S REPEAT RATE control ⑫ for the desired repeat rate.

5. Set the SINGLE DELAY switch ⑭ at REPEAT (up).

6. Adjust the ECHO/S ON S INTENSITY control ⑩ so as to produce the desired number of echo repetitions.

USING THE SOUND-ON-SOUND EFFECT

Set the controls at their normal positions as given previously.

1. Depress the S ON S (sound-on-sound) EFFECT ON/OFF switch ⑫ and note that the S ON S indicator ② lights.

2. For repetitive sound-on-sound effects, set the SINGLE DELAY switch ⑭ at REPEAT (up) and use the ECHO/S ON S INTENSITY control ⑩ to control the number of repetitions.

USING THE SINGLE DELAY.

When using echo or sound-on-sound effects, setting the SINGLE DELAY switch ⑭ at SINGLE (down) will produce only one repetition of the effect.

USING REVERBERATION

Set the controls at their normal positions as given previously.

Set the REVERB VOLUME control ⑮ for the desired effect.

The four effects: chorus, echo, sound-on-sound, and reverberation can be used alone, or mixed together freely in any combination.

CONTROLS AND THEIR FUNCTIONS

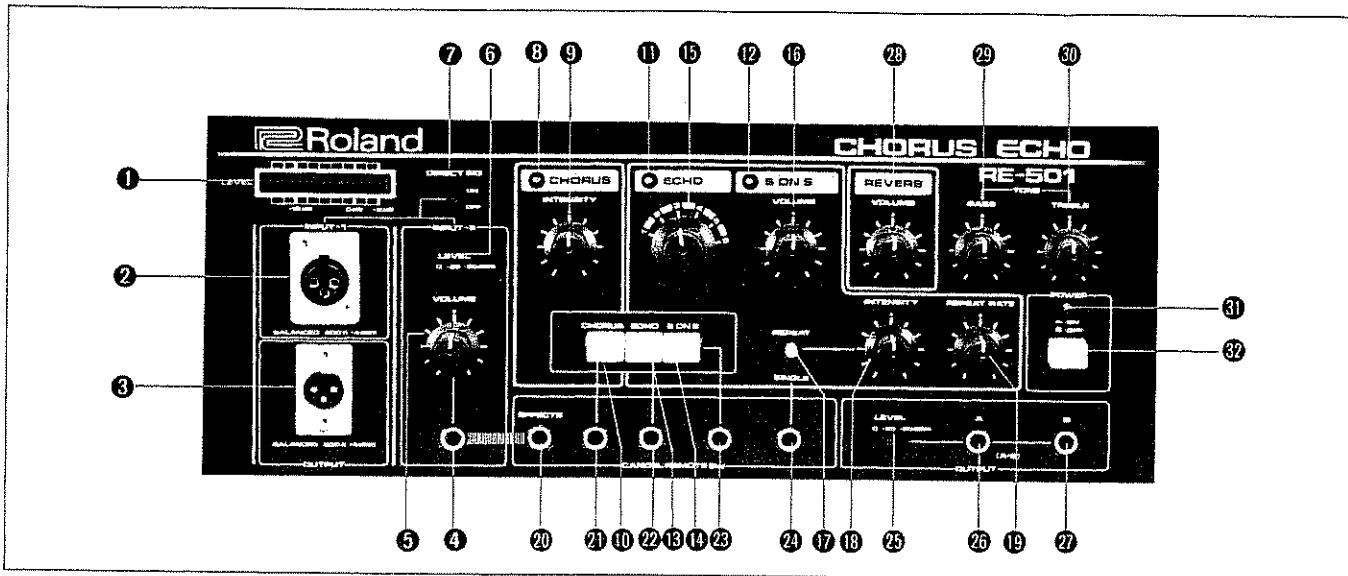

1 INPUT LEVEL INDICATOR
Set input level so normal reading is 0dB, with occasional peaks at +2dB.

2 BALANCED INPUT Connector (XLR) (600Ω)
+4dBm input causes INPUT LEVEL INDICATOR 1 to read 0dB. VOLUME control 5 does not affect balanced input.

3 BALANCED OUTPUT Connector (XLR) (600Ω)
When the INPUT LEVEL INDICATOR 1 reads 0dB, the balanced output will be +4dBm. This connector has no relation with the A and B outputs 26 27; all effects appear at this output.

4 UNBALANCED INPUT Jack
For guitar, keyboard, microphone, etc.

5 VOLUME Control
Controls input level from UNBALANCED INPUT 4

6 INPUT LEVEL SELECTOR Switch
For level matching. Example settings: Microphone: -50dBm; Guitar: -25dBm; Synthesizer: 0dBm; Mixer: 0dBm or -25dBm.

7 DIRECT SIGNAL Switch
When OFF, only the effect signals will appear at the outputs. Use this mode in effect loops such as with mixer SEND/RETURN jacks. When ON, the direct signal will be mixed with the effect outputs.

8 CHORUS Indicator
Lights when the chorus effect is ON.

9 CHORUS INTENSITY Control
Controls the intensity of the chorus effect when ON.

10 CHORUS ON/OFF Button
Depress for ON.

11 ECHO Indicator
Lights when the echo effect is ON.

12 S ON S (Sound-on-sound) Indicator
Lights when the sound-on-sound effect is ON.

13 ECHO ON/OFF Button
Depress for ON.

14 S ON S (Sound-on-sound) EFFECT ON/OFF Button
Depress for ON.

15 ECHO MODE SELECTOR Switch
ECHO 1, 2, and 3 are single slap echo modes; ECHO 4, 5, and 6 are multiple slap echo modes.

HEAD MODE \	1	2	3	4	5	6
PB1	●			●		●
PB2		●		●	●	●
PB3			●		●	●

16 ECHO/S ON S VOLUME Control
Controls the level of the echo and sound-on-sound effects without affecting the direct sound (when used).

17 SINGLE DELAY Switch
For producing single delay echo and sound-on-sound effects. Double and triple delays will be produced with the ECHO MODE switch 15 at 4, 5 or 6 because more than one playback head is being used.

18 ECHO/S ON S INTENSITY Control
Controls the number of echo and sound-on-sound repetitions. At about "7" or "8" ("8" = 3 o'clock), self oscillation occurs. Single delays can be produced at SINGLE DELAY.

19 ECHO/S ON S REPEAT RATE Control
Controls the time between echo and sound-on-sound repetitions by changing the tape speed. Interesting effects can be produced by changing the REPEAT RATE 19 while producing sound.

20, 21, 22, 23, 24 CANCEL REMOTE SWITCH Jacks.

For remote ON/OFF control of the various effects. 20 controls ON/OFF of all effects. 21, 22, and 23 controls ON/OFF of the chorus, echo, and sound-on-sound effects. 24 allows switching between SINGLE and REPEAT effects.

25 OUTPUT LEVEL SELECTOR Switch
For level matching of the UNBALANCED OUTPUTS 26 27. Example of use: Microphone amplifier: -50dBm; Guitar amplifier: -25dBm.

26 27 A and B OUTPUT Jacks (unbalanced)
When using only one amplifier, use the A OUTPUT 26. Use both OUTPUTS 26 27 with two amplifiers for stereo effects. When the A OUTPUT 26 only is used, all effects will appear at the A OUTPUT 26.

28 REVERB VOLUME Control
Controls the level of the reverberation effect.

29 BASS TONE Control

30 TREBLE TONE Control
For tone control of the effects. Leave controls straight up for flat response. Does not affect direct sound.

31 PILOT Lamp

32 POWER Switch

ABOUT THE INPUTS AND OUTPUTS.

The inputs and outputs may be used freely in any desired combination. The BALANCED INPUT 2 and the UNBALANCED INPUT 4 are mixed internally so that both may be used simultaneously, if desired. The output produces enough power so that the BALANCED OUTPUT 3 and UNBALANCED OUTPUTS 26 27 may also be used simultaneously.

USING THE RE-501

Example 1:

For adding spatial effects to keyboard and vocal music. Set the controls for the desired effect.

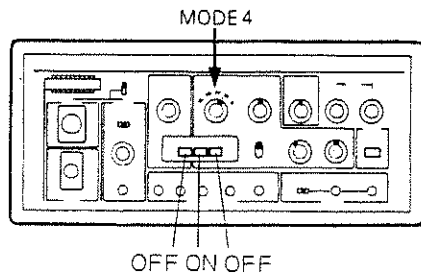

Example 2:

For producing spatial effects with very long delays for a science fiction-like effect. Good input sounds are those which are relatively sustaining and have a slow attack. This setting uses sound-on-sound with a long delay.

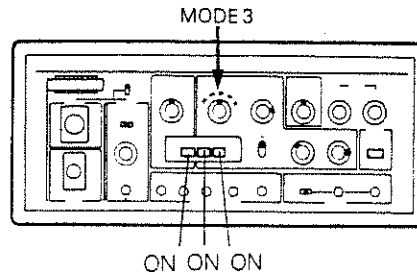

Example 3:

With the REPEAT control ● set so as to produce a delay of from 0.55 to 1.8 seconds, individual phrases can be joined together for a continuous effect.

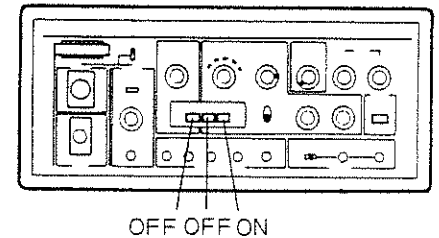

TO REPLACE TAPE

- Remove the five nuts and the acrylic cover.
- Remove the old tape; clean all surfaces that come in contact with the tape, including bearings, heads, guides, motor shaft, etc. Use tape head cleaner.
- Place the new tape-pack as shown. Pull the tape out and set it as shown. It is a good idea to avoid direct contact of your skin and the exposed tape by wearing clean cotton gloves.
- Replace the acrylic cover. The empty tape-pack may be left in place until it is time to change tapes again.
- Turn on the power switch to run the tape. Approximately five minutes of running is required to insure good tape-to-head contact.
- The replacement tape RT-1L should last over 300 hours.

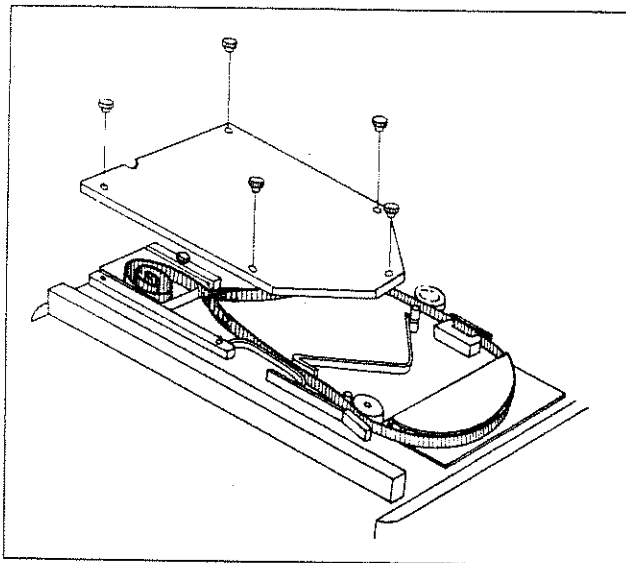

CLEANING

The part indicated with arrows should be cleaned regularly in order to maintain good sound quality. Pay particular attention to the tape heads. Use cotton-tipped swabs and rubbing alcohol or a commercial tape head cleaner.

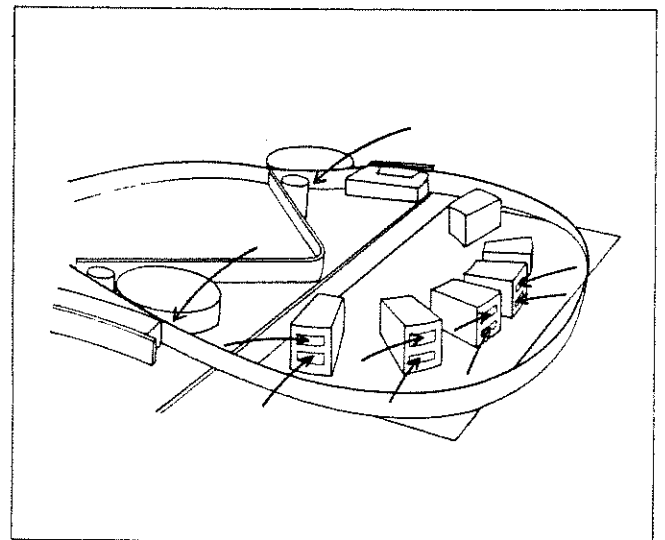

SPECIFICATIONS

Input Level/Impedance

Balanced:	+4 dBm/30 k Ω
Unbalanced:	0 dBm/47 k Ω
	-25 dBm/220 k Ω
	-50 dBm/6.6 k Ω

Output Level/Impedance

Balanced:	+4 dBm/600 Ω
Unbalanced:	0 dBm/More than 5K Ω
	-25 dBm/More than 5K Ω
	-50 dBm/More than 5K Ω

Jacks

Input Jack (XLR ② 1/4" phone jack ①)	:2
Output Jack (XLR ③ 1/4" phone jack ④ ⑦)	:3
Cancel Remote Jack	:5

Controls

Input Volume ⑤
Chorus Intensity ④
Echo/Son S: Volume ⑩
Intensity ⑪
Repeat Rate ⑫
Reverb Volume ⑬
Effect Tone: Treble ⑭
Bass ⑮

Switches

Input-2-Level Switch (0, -25, -50 dBm) ⑥
Output A-B Level Switch (0, -25, -50 dBm) ⑧
Mode Selector (1-6) ⑨
Chorus Switch ⑩
Echo Switch ⑪
S on S Switch ⑫
Single Delay Switch ⑬
Direct Signal Switch ⑭
Power Switch ⑮

Indicator

Level Meter (LED Display) ①
Chorus ②
Echo ③
S on S ④
Pilot ⑤

Power Consumption :	24W
Dimensions :	418(W) x 190(H) x 330(D) mm
	16 1/2 (W) x 7 1/2(H) x 13(D) ins.
Weight :	10.5kg
	23 lb. 2 oz.
Accessories :	Connection cord (x2)
	Tape (RT-1L)
	Head Cleaner

*Specifications are subject to change without notice.

«NOTES»

- Clean the control panel with neutral detergent. Use a soft, dry cloth for the wooden parts. Do not use solvents such as paint thinner.
- Avoid using this unit in very high or low temperature locations. Also keep away from heaters and air-conditioners since this type of equipment will affect circuit stability.
- If it is necessary to use this unit in an area with neon or fluorescent lights, keep it as far away from these lights as possible since they will induce high levels of noise. Sometimes changing the angle of this unit in relation to the lights will help reduce noise.

OPTIONAL ACCESSORIES

FOOTSWITCH

FS-1

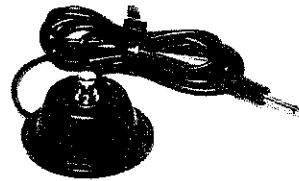

FS-2

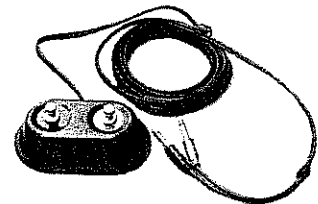

FS-3

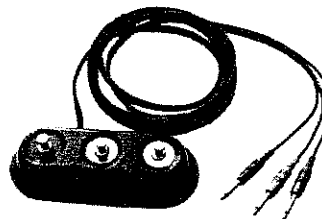

Roland®

10396

UPC

10396



10396

Roland®

Free Manuals Download Website

<http://myh66.com>

<http://usermanuals.us>

<http://www.somanuals.com>

<http://www.4manuals.cc>

<http://www.manual-lib.com>

<http://www.404manual.com>

<http://www.luxmanual.com>

<http://aubethermostatmanual.com>

Golf course search by state

<http://golfingnear.com>

Email search by domain

<http://emailbydomain.com>

Auto manuals search

<http://auto.somanuals.com>

TV manuals search

<http://tv.somanuals.com>