



Roland®

FR-7/FR-5



Owner's Manual

WARNING – To reduce the risk of fire or electric shock, do not expose this device to rain or moisture.

  
ATTENTION: RISQUE DE CHOC ELECTRIQUE NE PAS OUVRIR
CAUTION: TO REDUCE THE RISK OF ELECTRIC SHOCK, DO NOT REMOVE COVER (OR BACK). NO USER-SERVICEABLE PARTS INSIDE. REFER SERVICING TO QUALIFIED SERVICE PERSONNEL.



The lightning flash with arrowhead symbol, within an equilateral triangle, is intended to alert the user to the presence of uninsulated "dangerous voltage" within the product's enclosure that may be of sufficient magnitude to constitute a risk of electric shock to persons.



The exclamation point within an equilateral triangle is intended to alert the user to the presence of important operating and maintenance (servicing) instructions in the literature accompanying the product.

INSTRUCTIONS PERTAINING TO A RISK OF FIRE, ELECTRIC SHOCK, OR INJURY TO PERSONS.

IMPORTANT SAFETY INSTRUCTIONS SAVE THESE INSTRUCTIONS

WARNING – When using electric products, basic precautions should always be followed, including the following:

1. Read these instructions.
2. Keep these instructions.
3. Heed all warnings.
4. Follow all instructions.
5. Do not use this apparatus near water.
6. Clean only with a dry cloth.
7. Do not block any of the ventilation openings. Install in accordance with the manufacturers instructions.
8. Do not install near any heat sources such as radiators, heat registers, stoves, or other apparatus (including amplifiers) that produce heat.
9. Do not defeat safety purpose of the polarized or grounding-type plug. A polarized plug has two blades with one wider than the other.
A grounding type plug has two blades and third grounding prong. The wide blade or the third prong are provided for your safety. If the provided plug does not fit into your outlet, consult an electrician for replacement of the obsolete outlet.
10. Protect the power cord from being walked on or pinched particularly at plugs, convenience receptacles, and the point where they exit from the apparatus.
11. Only use attachments/accessories specified by the manufacturer.
12. Unplug this apparatus during lightning storms or when unused for long periods of time.
13. Refer all servicing to qualified service personnel. Servicing is required when the apparatus has been damaged in any way, such as power-supply cord or plug is damaged, liquid has been spilled or objects have fallen into the apparatus, the apparatus has been exposed to rain or moisture, does not operate normally, or has been dropped.

For the U.K.

WARNING: THIS APPARATUS MUST BE EARTHED
IMPORTANT: THE WIRES IN THIS MAINS LEAD ARE COLOURED IN ACCORDANCE WITH THE FOLLOWING CODE.
GREEN-AND-YELLOW: EARTH, BLUE: NEUTRAL, BROWN: LIVE
As the colours of the wires in the mains lead of this apparatus may not correspond with the coloured markings identifying the terminals in your plug, proceed as follows:
The wire which is coloured GREEN-AND-YELLOW must be connected to the terminal in the plug which is marked by the letter E or by the safety earth symbol  or coloured GREEN or GREEN-AND-YELLOW.
The wire which is coloured BLUE must be connected to the terminal which is marked with the letter N or coloured BLACK.
The wire which is coloured BROWN must be connected to the terminal which is marked with the letter L or coloured RED.

The technology used in the FR-5 and FR-7 is covered by patents pending in certain countries throughout the world.

Roland

FR-7/FR-5



Owner's Manual

Thank you for purchasing the Roland FR-7/FR-5 V-Accordion. The FR-7/FR-5 is an amazingly versatile electronic instrument that can emulate the sounds of a vast array of accordions. You may know that the term "accordion" refers to a portable musical instrument of the free reed family, that its sound is controlled by air flow from the bellows, and that there are almost as many types as there are countries. The accordion family indeed includes instruments called "Aeloine", "Aerophone", "Bayan", "Buzika", "Concertina", "Drängkammarrorgel", "Fisarmonica", "Hanuri", "Melodeon", "Pedalowka", "Schwyzerorgeli", "Squeeze Box", "Sun Fin Chin", and many others.

For the first time in history, Roland introduces an accordion instrument that can emulate (recreate) the sounds and behavior of several bellows instruments. Though it is also the most sophisticated MIDI controller to date (even more powerful than any keyboard instrument), the major advantage of the FR-7/FR-5 is probably that it allows you to change sounds without changing instruments. Apart from the financial benefit (the FR-7/FR-5 costs far less than what you have to pay for the emulated originals), this also means that you can use your familiar playing style and techniques while covering a host of different musical genres.

To get the most out of the FR-7/FR-5 and to ensure many years of trouble-free service, we urge you to read through this Owner's Manual thoroughly.

Before using this instrument, carefully read the "Important notes" (p. 9). They provide information concerning the proper operation of the FR-7/FR-5. Be sure to keep this manual in a safe place for future reference.

Contents

1. Features	6
2. Important notes	9
3. Panel descriptions	11
Treble control panel	11
Bass control panel	12
Display and master bar	12
Connection panel	13
4. Setting up	14
Connections	14
Switching the power on and off	15
Listening to the demo songs	16
First steps	17
Touring the FR-7/FR-5's sections	20
Using the orchestral sounds	24
Other practical functions	28
5. About the FBC-7	31
Using the FBC-7	31
Charging the battery	32
6. Editing sounds	35
Selecting parameters	35
Setting parameter values	37
TUNING parameters	38
TREBLE EDIT parameters	40
BASS EDIT parameters	45
FREE BASS EDIT parameters	48
ORC.BASS EDIT parameters	51
ORCH. EDIT parameters	53
SET COMMON parameters	55
SYSTEM parameters	59
UTILITY parameters	63
7. MIDI functions	66
About MIDI	66
Global MIDI parameters	69
MIDI parameters for the various sections/parts	72
Archiving your settings via MIDI (Bulk Dump)	75
8. Miscellaneous functions	77
Saving settings using the WRITE function	77
Restoring the factory defaults	78
Troubleshooting	79
Specifications	81
Parameter list	82
Factory Sets	85
Demo Songs	85
9. MIDI implementation	86
MIDI Implementation Chart	88
10. Information	89
11. Index	90

1. Features

Stand-alone electronic instrument

Though the FR-7/FR-5 is a fully electronic instrument, you do not need to connect the FR-7 to an amplifier in order to produce sounds. Its onboard amplification system is powerful enough for small venues, restaurants, etc. (The FR-5 has no internal amplification.)

Furthermore, the FR-7 comes with a rechargeable battery (Ni-Mh) so that you do not need to connect it to a wall outlet. The battery should last ± 8 hours. (The battery is available as an optional item for the FR-5.)

Sophisticated MIDI control

The FR-7/FR-5 is the most versatile and "musical" MIDI controller to date, going far beyond the control possibilities of a MIDI keyboard with optional performance functions or of MIDI'fied wind instruments.

The piano-style Treble keyboard even transmits after-touch messages.

PBM (Physical Behavior Modeling)

The FR-7/FR-5 V-Accordion is based on Roland's latest sound generation technology called "PBM" (Physical Behavior Modeling) whose sonic result is very close to the sound of traditional accordions.

Super realistic accordion simulations

The FR-7/FR-5 provides 40 memories called "Sets", with 14 treble registers, 7 bass & chord registers and 7 free bass registers each. All sounds it produces were obtained by sampling the most popular traditional acoustic accordions. Different tuning systems are also available.

This V-Accordion allows you to switch from an Italian jazz accordion to German folk, French musette or a historic bandoneon sound – without changing your technique.

Orchestral sounds

22 orchestral sounds can be used in combination with traditional accordion sounds – complete with full bellows articulation (something like breath control for accordions, but much more refined) and unique keyboard modes (Solo, Dual, High and Low).

Orchestra Bass

The FR-7/FR-5 also provides 7 orchestral bass sounds for the Bass section that can be added to the Bass accordion sound.

The digital advantage

The V-Accordion includes all functions and sounds of a traditional accordion, thus conveying a really natural feel and sound. Yet it also provides the advantages only an electronic musical instrument can give you:

- reduced overall weight;
- possibility to choose among a wide variety of sounds;
- you can create and customize the accordion timbres (program your own sounds);
- you can choose among various bass button operation modes (Minor 3rd Free Bass, 5th, Bayan, North Europe, etc.);
- tuning stability over time and wear resistance of all mechanical parts;
- you can sound in a different key than the one you are playing in (transpose function);
- you can play with headphones, i.e. without disturbing your neighbors or family.

Superb performance flexibility

The V-Accordion allows you to control external MIDI-compatible instruments. The Treble keyboard and chord/bass buttons are velocity-sensitive, while the bellows controller provides more articulation possibilities than any other MIDI keyboard, MIDI wind instrument, etc., you may know.

In High or Low mode (see p. 25), you can control up to 4 parts simultaneously (two sounds in the right hand/two sounds in the left).

-
- All product names mentioned in this document are trademarks or registered trademarks of their respective owners.

USING THE UNIT SAFELY

INSTRUCTIONS FOR THE PREVENTION OF FIRE, ELECTRIC SHOCK, OR INJURY TO PERSONS

About ⚠ WARNING and ⚠ CAUTION Notices

⚠ WARNING	Used for instructions intended to alert the user to the risk of death or severe injury should the unit be used improperly.
⚠ CAUTION	Used for instructions intended to alert the user to the risk of injury or material damage should the unit be used improperly. * Material damage refers to damage or other adverse effects caused with respect to the home and all its furnishings, as well to domestic animals or pets.

About the Symbols

	The ⚠ symbol alerts the user to important instructions or warnings. The specific meaning of the symbol is determined by the design contained within the triangle. In the case of the symbol at left, it is used for general cautions, warnings, or alerts to danger.
	The ⓧ symbol alerts the user to items that must never be carried out (are forbidden). The specific thing that must not be done is indicated by the design contained within the circle. In the case of the symbol at left, it means that the unit must never be disassembled.
	The ● symbol alerts the user to things that must be carried out. The specific thing that must be done is indicated by the design contained within the circle. In the case of the symbol at left, it means that the power-cord plug must be unplugged from the outlet.

ALWAYS OBSERVE THE FOLLOWING

⚠ WARNING

- Before using this instrument, read the instructions below and the Owner's Manual.

- Do not open or perform any internal modifications on the unit.

- Do not attempt to repair the FR-7/FR-5 or FBC-7 or replace parts within it (except when this manual provides specific instructions directing you to do so). Refer all servicing to your retailer, the nearest Roland Service Center or an authorized Roland distributor, as listed on the "Information" page.

- Never use or store the FR-7/FR-5 or FBC-7 in places that are:
 - Subject to temperature extremes (e.g., direct sunlight in an enclosed vehicle, near a heating duct, on top of heat-generating equipment); or are
 - Damp (e.g., baths, washrooms, on wet floors); or are
 - Humid; or are
 - Exposed to rain; or are
 - Dusty; or are
 - Subject to high levels of vibration.

- When not in use, do not place the FR-5 or FR-7 vertically due to instability. If placed in the vertical position on the floor/stage, ensure that it leans against a stable vertical surface e.g. a wall or a heavy musical instrument.

- The FBC-7 should only be connected to a power supply of the type described in the operating instructions or as marked on the bottom of the FBC-7.

⚠ WARNING

- Do not excessively twist or bend the power cord, nor place heavy objects on it. Doing so can damage the cord, producing severed elements and short circuits. Damaged cords are fire and shock hazards!

- This instrument, either alone or in combination with an amplifier and headphones or speakers, may be capable of producing sound levels that could cause permanent hearing loss. Do not operate for a long period of time at a high volume level or at a level that is uncomfortable. If you experience any hearing loss or ringing in the ears, you should immediately stop using the FR-7/FR-5 or FBC-7 and consult an audiologist.

- Do not allow any objects (e.g., flammable material, coins, pins); or liquids of any kind (water, soft drinks, etc.) to penetrate the FR-7/FR-5 or FBC-7.

- In households with small children, an adult should provide supervision until the child is capable of following all rules essential for the safe operation of the FR-7/FR-5 or FBC-7.

- Protect the FR-7/FR-5 and FBC-7 from strong impact. (Do not drop it!)

- Immediately turn the power off, remove the power cord from the outlet and request servicing by your retailer, the nearest Roland Service Center or an authorized Roland distributor, as listed on the "Information" page when:
 - The power-supply cord or the plug has been damaged; or
 - Objects have fallen into or liquid has been spilled onto the FR-7/FR-5 or FBC-7; or
 - The unit has been exposed to rain (or otherwise has become wet); or
 - The unit does not appear to operate normally or exhibits a marked change in performance.

- Do not force the FBC-7's power cord to share an outlet with an unreasonable number of other devices. Be especially careful when using extension cords—the total power used by all devices you have connected to the extension cord's outlet must never exceed the power rating (watts/amperes) for the extension cord. Excessive loads can cause the insulation on the cord to heat up and eventually melt through.



⚠ WARNING

- Before using the FBC-7 in a foreign country, consult with your retailer, the nearest Roland Service Center or an authorized Roland distributor, as listed on the "Information" page.



⚠ CAUTION

- The FR-7/FR-5 or FBC-7 should be located so that its location or position does not interfere with its proper ventilation.



- Always grasp only the plug on the power-supply cord when plugging into or unplugging from, an outlet or this unit.



- Try to prevent cords and cables from becoming entangled. Also, all cords and cables should be placed out of the reach of children.



- Never climb on top of, nor place heavy objects on the FR-7/FR-5 or FBC-7.



- Never handle the power cord or its plugs with wet hands when plugging into or unplugging from, an outlet or this unit.



- If you need to move the FBC-7, take note of the precautions listed below. Make sure to have a firm grip, to protect yourself from injury and the instrument from damage.
 - Disconnect the power cord.
 - Disconnect all cords coming from external devices.



- Before cleaning the FR-7/FR-5, turn off the power and unplug the power cord from the outlet.



- Whenever you suspect the possibility of lightning in your area, disconnect the FBC-7's power cord from the outlet.



- Should you remove screws, make sure to put them in a safe place out of children's reach, so there is no chance of them being swallowed accidentally.



2. Important notes

In addition to the items listed under "Using the unit safely" on p. 7, please read and observe the following:

Power supply

- Do not use this instrument on the same power circuit with any device that will generate line noise (such as an electric motor or variable lighting system).
- Before connecting the FR-7/FR-5 to other devices, turn off the power to all units. This will help prevent malfunctions and/or damage to speakers or other devices.
- Although the LCD and LEDs are dark when the POWER switch is off, this does not mean that the unit has been completely disconnected from the power source. To turn off the power completely, first turn off the POWER switch, then unplug the power cord from the wall outlet. For this reason, the outlet to which you connect the power cord's plug should be one that is within easy reach.

Placement

- Using the FR-7/FR-5 near power amplifiers (or other equipment containing large power transformers) may induce hum. To alleviate the problem, change the orientation of this unit; or move it farther away from the source of interference.
- This device may interfere with radio and television reception. Do not use this device in the vicinity of such receivers.
- Do not place the FR-7/FR-5 near devices that produce a strong magnetic field (e.g., loudspeakers).
- Install the FR-7/FR-5 on a solid, level surface.
- Noise may be produced if wireless communications devices, such as cell phones, are operated in the vicinity of this unit. Such noise could occur when receiving or initiating a call or while conversing. Should you experience such problems, relocate such wireless devices so they are at a greater distance from this unit or switch them off.
- Do not expose the unit to direct sunlight, place it near devices that radiate heat, leave it inside an enclosed vehicle or otherwise subject it to temperature extremes. Also, do not allow lighting devices that normally are used while their light source is very close to the unit (such as a piano light) or powerful spotlights to shine upon the same area of the unit for extended periods of time. Excessive heat can deform or discolor the unit.
- To avoid possible breakdown, do not use the unit in a wet area, such as an area exposed to rain or other moisture.
- Do not allow rubber, vinyl or similar materials to remain on the instrument for long periods of time. Such objects can discolor or otherwise harmfully affect the finish.
- Do not put anything that contains water (e.g., flower vases) on the instrument. Also, avoid the use of insecticides, perfumes, alcohol, nail polish, spray cans, etc., near the unit. Swiftly wipe away any liquid that spills on the unit using a dry, soft cloth.
- Do not allow objects to remain on top of the keyboard or buttons. This can be the cause of malfunction, such as keys or buttons ceasing to produce sound.
- Do not paste stickers, decals or the like on this instrument. Peeling these off, particularly when strong adhesives have been used, can damage the instrument's exterior finish (the stickers provided with this instrument feature a weak adhesive).

Maintenance

- For everyday cleaning wipe the FR-7/FR-5 with a soft, dry cloth or one that has been slightly dampened with water. To remove stubborn dirt, use a mild, non-abrasive detergent. Afterwards, be sure to wipe the instrument thoroughly with a soft, dry cloth.
- Never use benzene, thinner, alcohol or solvents of any kind, to avoid the possibility of discoloration and/or deformation.

Repairs and data

- Please be aware that all data contained in the instrument's memory may be lost when it is sent for repairs. In certain cases (such as when circuitry related to memory itself is out of order), we regret that it may not be possible to restore the data. Roland assumes no liability concerning such loss of data.

Additional precautions

- Please be aware that the memory contents can be irretrievably lost as a result of a malfunction or the improper operation of the instrument. Therefore, be sure to archive important settings using the FR-7/FR-5's Bulk Dump function (see p. 75).
- Use a reasonable amount of care when using the instrument's buttons, other controls and jacks/connectors. Rough handling can lead to malfunctions.
- Never strike or apply strong pressure to the display.
- When connecting/disconnecting cables, grasp the connector itself—never pull on the cable. This way you will avoid causing shorts or damage to the cable's internal elements.
- A small amount of heat will radiate from the instrument during normal operation. This is perfectly normal.
- To avoid disturbing your neighbors, try to keep the instrument's volume at reasonable levels. You may prefer to use headphones, so you do not need to be concerned about those around you (especially late at night).
- When you need to transport the instrument, package it in the box (including padding) that it came in. Otherwise, you will need to use equivalent packaging materials or a flightcase.
- Use only the specified expression pedal (EV-5, EV-8; sold separately). By connecting any other expression pedals, you risk causing malfunction and/or damage to the FR-7/FR-5.
- Use a cable from Roland to make the connection. If using some other make of connection cable, please note the following precautions. Some connection cables contain resistors. Do not use cables that incorporate resistors for connecting to this unit. The use of such cables can cause the sound level to be extremely low or impossible to hear. For information on cable specifications, contact the manufacturer of the cable.

Precautions for the included (FR-7) or optional (FR-5) battery

- The temperature range for use of the batteries is as follows. Using them outside this range may impair battery performance and shorten battery service life. *Use (discharging):* 0~50°C, *Storage:* -20~30°C, *Charging:* 0~40°C.
- Do not use or store a battery at high temperature, such as in strong direct sunlight, in cars during hot weather or directly in front of heaters. This may cause battery fluid leakage, impaired performance and shorten the battery's service life.
- Do not charge a battery while it is cold (below 0°C) or outside when it is freezing. This may cause battery fluid leakage, impaired performance and shorten the battery's service life.
- Do not splash fresh or saltwater on a battery or allow the terminals to become damp. This may cause heat generation and formation of rust on the battery and its terminals.
- Use only the supplied FBC-7 to charge the FR-7/FR-5's battery. Failure to follow proper charging procedures may cause excessive current flow, loss of control during charging, leakage of battery fluid, heat generation, bursting or fire.
- For the procedure for charging the FR-7/FR-5's battery, please read page 32.

- **Do not connect the battery directly to a power outlet or insert it into a cigarette lighter socket in a car.** High voltage may cause excessive current flow, leakage of battery fluid, heat, bursting or fire.
- If a newly purchased battery exhibits rust, generates heat or seems abnormal in any other way, do not use it. Take it back to your Roland dealer.
- Be sure to fully deplete a battery before recharging it for the first time.
- Keep the battery out of reach of babies or small children. Ensure that babies or small children cannot remove a battery from the FBC-7 while it is being charged.
- Be sure to carefully instruct any person on the proper way of handling a battery.
- Never dispose of the battery in a fire. Never heat it. Doing so may melt the insulation, damage the gas release vents or protective devices, cause combustion through chemical reaction with generated hydrogen, ejection of battery fluid, bursting or fire.
- Do not charge or use the battery with the positive (+) and negative (-) terminals reversed, as this may drain the battery or cause abnormal chemical reactions. Under normal operation, this should be impossible, because the battery or cable can only be connected in one direction.
- Do not remove the outer tube from a battery or damage it.
- Do not strike or drop the battery. Strong impact can cause leakage of battery fluid, heat generation, bursting or fire.
- Never try to connect two batteries in parallel as this may cause leakage of battery fluid, heat generation, bursting or fire.
- Do not alter or remove protective mechanisms or other parts. Never disassemble the battery.
- The positive (+) terminal section of the battery is equipped with a gas release vent. Never deform this section or cover it. Do not obstruct the release of gas as this could result in leakage of battery fluid, heat generation, bursting or fire.
- Do not overcharge the battery by exceeding the predetermined charging period of the FBC-7 or indicator. Never recharge a battery that is already fully charged. This could result in leakage of battery fluid, heat generation, bursting or fire.
- If the battery is not fully charged after the predetermined charging period has elapsed, stop the charging process. Prolonged charging could result in leakage of battery fluid, heat generation, bursting or fire.
- If any fluid from a battery comes in contact with the eyes, flush the eyes immediately, washing them thoroughly with clean water from a tap or other source and consult a doctor. Strong alkaline fluid can damage the eyes and lead to permanent loss of eyesight.
- If skin or clothing comes in contact with any fluid from the battery, wash the area immediately with clean water from a tap. Battery fluid can cause skin damage.
- When a battery is no longer usable, dispose of it in accordance with all applicable local laws and regulations.
- If the battery leaks fluid, changes color or shape or changes in any other way, do not use it, otherwise it may cause heat generation, bursting or fire.

3. Panel descriptions

Treble control panel

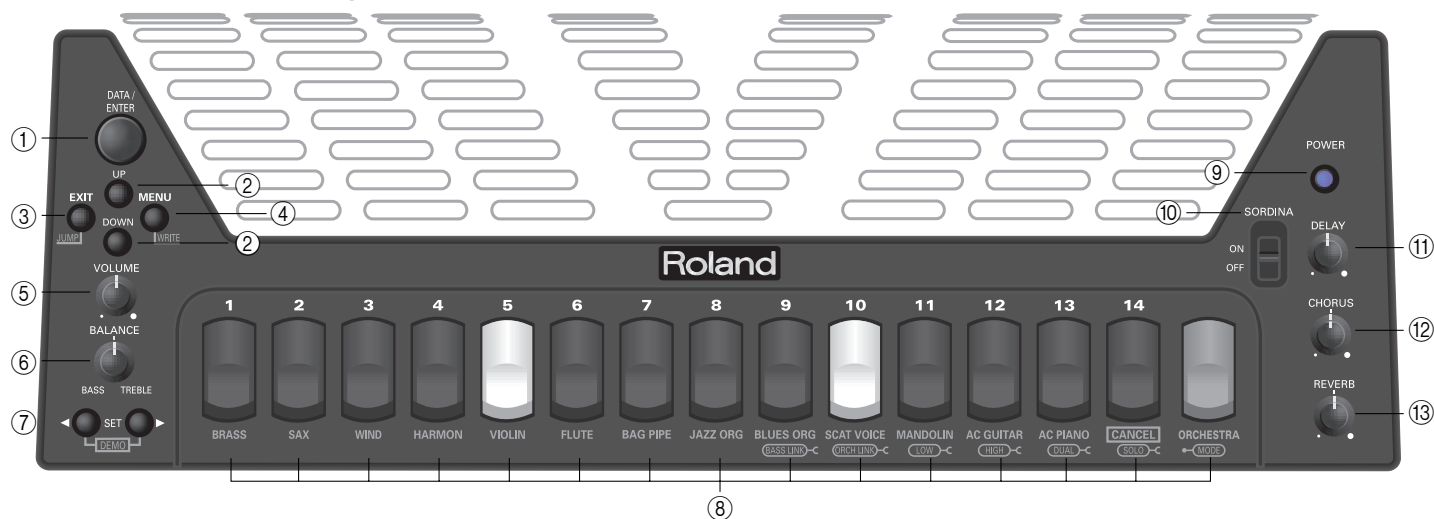

① **DATA/ENTER knob**

This knob allows you to enter values and to select menu entries or shortcuts by turning it. You can also press it (ENTER) to confirm a setting or to jump to another parameter in the display.

② **UP/DOWN buttons**

On the Main page, **[UP]** and **[DOWN]** allow you to select 6 important functions: TRANSPOSE (press **[UP]** once), MUSETTE DETUNE (press **[UP]** twice), SCALE TUNING (press **[UP]** three times), ORCHESTRA VOLUME (press **[DOWN]** once), ORCHESTRA BASS VOLUME (press **[DOWN]** twice) and VALVE & BUTTON NOISE (press **[DOWN]** three times).

After selecting the MENU, **[UP]** and **[DOWN]** are used to enter values (same function as the **[DATA/ENTER]** knob).

③ **EXIT/JUMP button**

The **[EXIT/JUMP]** button allows you to return to the Main page (the display page that is shown while you are playing the FR-7/FR-5). After selecting a Menu function, briefly pressing **[EXIT/JUMP]** takes you back to a higher level. Press it again to return to the Main page.

By holding down **[EXIT/JUMP]** while the Main page is displayed, you activate the JUMP function (see p. 35).

④ **MENU/WRITE button**

This button allows you to select the FR-7/FR-5's MENU environment where you can set and view the available functions. By holding down **[MENU/WRITE]**, you activate the WRITE function, which allows you to save your settings.

⑤ **VOLUME knob**

This knob allows you to set the V-Accordion's overall volume.

⑥ **BALANCE knob**

This knob allows you to set the balance between the Bass and the Treble sections. Turn it towards "BASS" to decrease the Treble section's volume. Turn it towards "TREBLE" to decrease the Bass section's volume.

⑦ **SET buttons**

These two buttons allow you to choose among 40 accordion Sets. Each Set contains suitable settings for the 14 Treble, 7 Bass, 7 Free Bass registers, 22 orchestral sounds and 7 orchestral bass sounds.

⑧ **Treble registers**

The Treble section provides the following 14 switches ("registers"):

1	Bassoon	8	Master
2	Bandon	9	Musette
3	Cello	10	Celeste
4	Harmon	11	Tremolo
5	Organ	12	Clarinet
6	Accord	13	Oboe
7	Violin	14	Piccolo

The **[ORCHESTRA]** register allows you to assign the Treble registers to the 22 on-board Orchestra sounds. Activate it, then press one of the registers 1~13 to select the desired sound ("BRASS", "SAX", "WIND", "HARMONICA", "VIOLIN", etc.). Press **[CANCEL]** to restore the "accordion functions" of registers 1~14.

Note: In Orchestra mode the first 9 registers provide access to two sounds (A/B) of the family whose name is printed below the register. To select a "B" sound, press the corresponding register twice.

By holding down **[ORCHESTRA]**, while pressing a register 9~14, you activate the Link functions (see p. 42) or select an Orchestra mode (see p. 25).

- ⑨ **POWER button**
Press this button to switch the V-Accordion on (the button lights) and off (button dark).
Note: The FR-7/FR-5 is automatically switched off after 10 minutes of inaction to save battery power. This can be changed, however (see p. 63).
- ⑩ **SORDINA switch**
This ON/OFF switch allows you to switch the simulation of the wooden resonance chamber on and off.
- ⑪ **DELAY knob**
The FR-7/FR-5 contains three digital effects that can be used simultaneously. This knob is used to set the level of the Delay (echo) effect (see p. 58).
- ⑫ **CHORUS knob**
Use this knob to set the level of the Chorus effect (see p. 56).
- ⑬ **REVERB knob**
Use this knob to set the level of the Reverb effect (see p. 55).

Bass control panel

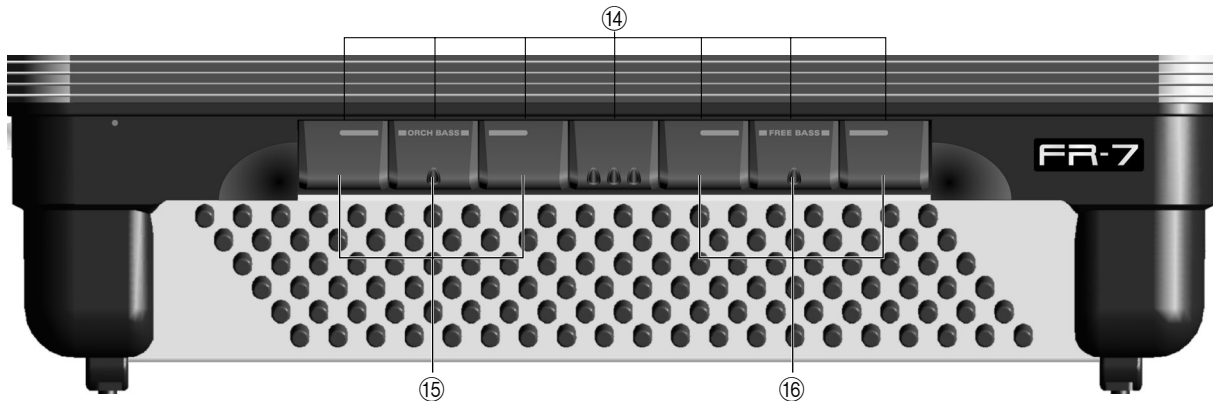

- ⑭ **Bass registers**
These switches allow you to select the desired bass mix. They include the following feet:

1	2'	5	8' ⁴ / ₂ '
2	4'	6	16' ⁸ / ₈ -4'
3	8-4'	7	16' ² / ₂ '
4	16' ⁸ / ₈ /8-4' ⁴ / ₂ '		
 - ⑮ **ORCH BASS registers**
Press the last three ("ORCH BASS") registers (viewed from the top) simultaneously to enter Orchestra Bass mode. Press the last three registers again simultaneously to return to normal bass mode.
 - ⑯ **FREE BASS registers**
Press the first three ("FREE BASS") registers (viewed from the top) simultaneously to enter Free Bass mode. The FR-7/FR-5 provides several systems for this mode (see p. 62). Press the first three registers again simultaneously to return to normal bass mode.
- Press the last three registers (viewed from the top) simultaneously to switch the Orchestra Bass section on or off (see p. 27).

Display and master bar

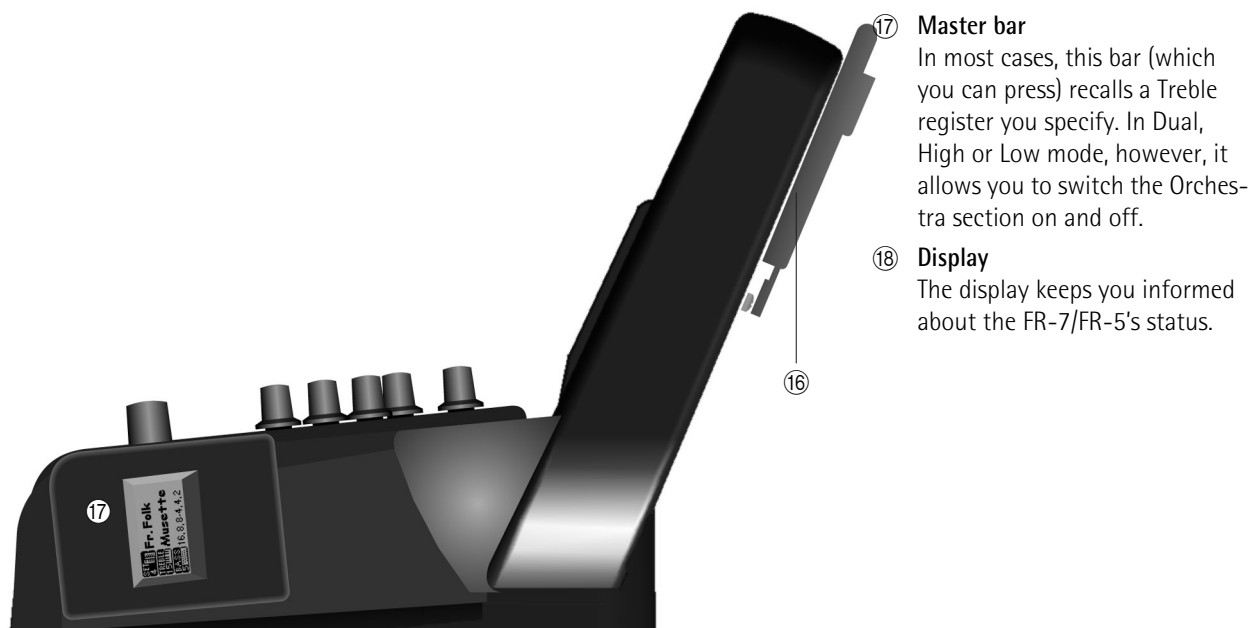

- ⑰ **Master bar**
In most cases, this bar (which you can press) recalls a Treble register you specify. In Dual, High or Low mode, however, it allows you to switch the Orchestra section on and off.
- ⑱ **Display**
The display keeps you informed about the FR-7/FR-5's status.

Connection panel



⑱ TO FBC-7 socket

Use the supplied cable to connect this socket to the supplied FBC-7 power supply/footswitch unit/battery charger. This may be necessary in the following cases:

- To power the FR-7/FR-5 without using the supplied battery. In most instances, this may be unnecessary, because the supplied battery (FR-7) lasts up to 8 hours.

Note: See also "Connecting the FBC-7" on p. 31 for details about maximizing the life span of the battery.

If you connect the 19-pin cable, be sure to never place the FR-7/FR-5 on the side when not using it.

- Always stand the V-Accordion on its rubber feet (and in the corresponding direction) to avoid damaging the 19-pin plug.
- Always handle and move the FR-7/FR-5 with care and pay special attention to the cable slack to avoid damaging or bending the 19-pin cable.
- If you place the FR-7/FR-5 on your lap, ensure that the 19-pin cable runs between you legs (not sideways) to avoid damaging or bending the 19-pin cable.

- To be able to control certain functions by foot (see p. 31).

- To use the FR-7/FR-5 as a MIDI controller (only the FBC-7 has MIDI sockets).

⑳ OUTPUT L/MONO & R/MONO sockets

These sockets can be connected to an amplifier, a mixing console or a wireless system.

If you use both connectors, the FR-7/FR-5's output is stereo. If you only use one jack (connected to the "L" or "R" socket), the FR-7/FR-5's output is mono.

Note: If you don't want to use a wireless system, consider connecting the FR-7/FR-5 to the FBC-7 when you need to connect it to an external amplifier.

Note: On the FR-7, connecting jacks to these sockets does not mute the internal speakers.

㉑ PHONES socket

This is where you can connect stereo headphones (Roland RH-25, RH-50 or RH-200). On the FR-7, connecting a pair of headphones mutes the internal speakers.

Connection panel of the FBC-7



① POWER ON switch

Press it to switch the FBC-7 (but not the FR-7/FR-5) on and off.

② AC connector

This is where you need to connect the supplied power cable. See also page 15.

③ MIDI THRU/OUT/IN sockets

Use these sockets to connect the FR-7/FR-5 to external MIDI gear (see p. 66).

④ OUTPUT R/MONO & L/MONO sockets

Connect these sockets to an external amplifier or mixing console. For stereo operation, be sure to connect both jacks.

⑤ EXPRESSION PEDAL socket

This is where you can connect an optional EV-series expression pedal (see p. 31).

⑥ TO FR7/5 V-ACCORDION socket

Use the supplied 19-pin cable to connect this socket to your FR-7/FR-5 (see p. 31).

Note: See also "Using the FBC-7" on p. 31 for additional functions of the FBC-7.

4. Setting up

Connections

The FR-7 can be used without any connections to either an amplification system or the FBC-7 power supply/battery charger unit. An FR-5 without an optional battery needs to be connected to the supplied FBC-7, however.

Connecting the FR-7/FR-5 to the supplied FBC-7

If you do not have a battery (FR-5) or prefer not to use it (FR-7), you need to connect the V-Accordion to the FBC-7 using the supplied cable. That cable powers the FR-7/FR-5, transmits pedal messages and sends the FR-7/FR-5's audio signals to the OUTPUT L/MONO & R sockets on the FBC-7.

In that case, there is no real need to connect the OUTPUT sockets on the FR-7/FR-5 to an external amplifier.

Connect the FR-7/FR-5 as shown in the illustration.

Note: This connection is required if you wish to take advantage of the FR-7/FR-5's MIDI functions (see p. 66).

The FR-7/FR-5's sounds have been arranged in such a way as to provide a **natural stereo image**. If you connect the V-Accordion to a mixing console, set the PAN control of the input to which the OUTPUT L socket (Treble section) is connected to "11 o'clock" and the PAN control of the channel to which the OUTPUT R socket (Bass & chord section) is connected to "3 o'clock" to preserve this balance. Something like this: . This setting can be changed, however (see p. 62).

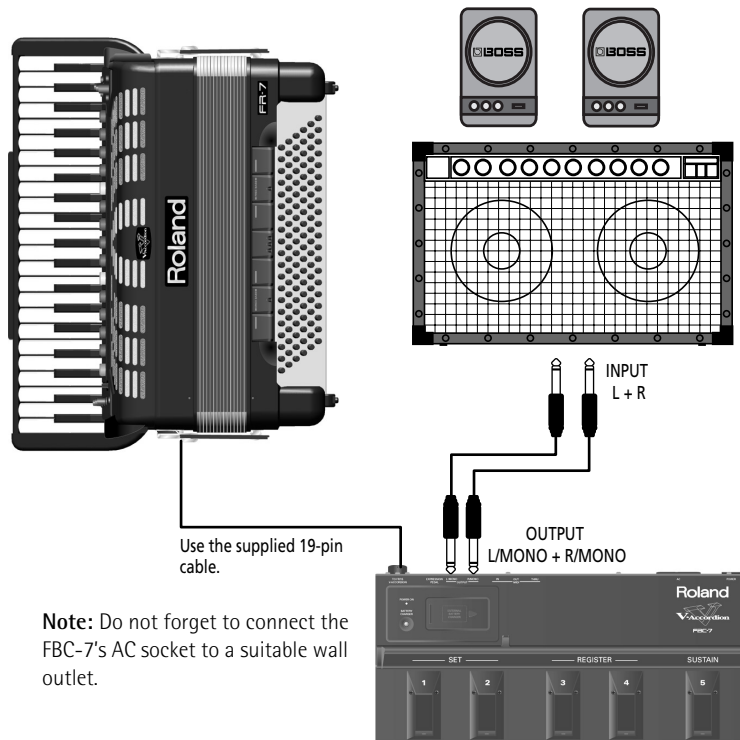

Using the OUTPUT sockets

If you are using the supplied rechargeable battery (FR-7) and need to connect the FR-7/FR-5 to a PA system or mixer, we recommend using a wireless system to avoid having to use an excessively long signal cable.

The FR-7 is equipped with an internal speaker system and thus does not need to be connected to an amplifier at all. The FR-5, on the other hand, does require an audio connection. As long as it does not contain an optional battery, we recommend connecting it to the FBC-7 (see above).

You can also use a pair of headphones (Roland RH-25, RH-50 or RH-200). In the case of the FR-7, connecting headphones switches off the internal speakers.

Note: The FR-7/FR-5's OUTPUT sockets are also available if you connect the FR-7/FR-5 to the FBC-7. Do not try to connect them to any of the FBC-7's sockets, because that does not work.

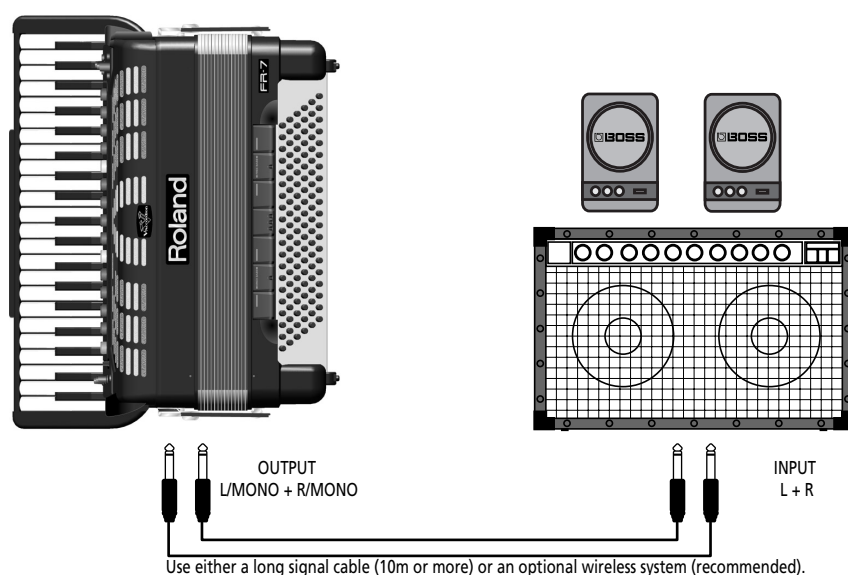

Switching the power on and off

The power-on procedure depends on whether you are using a battery or the FBC-7 Foot Pedal/DC Power/ Battery Charger Unit.

Note: Only use the battery that either came with your FR-7 or that you purchased from your Roland dealer. Using other batteries can severely damage the FR-7/FR-5 or FBC-7. Roland assumes no responsibility for damages caused by batteries that have not been explicitly approved. Such damages are not covered by Roland's warranty regulations.

If you are using a battery and no external amplification (FR-7 only)

- (1) Press the FR-7's **POWER** button (it lights) to switch it on.



Note: You can also connect headphones.

- (2) Start playing (see "First steps" on page 17).
- (3) Press the **POWER** button again so that it goes dark when you are finished.

If you are using a battery and an audio connection to an external device

The FR-5 needs to be connected to an amplification system of some sort (unless you want to use headphones), while you also need the FBC-7.

Note: You can also purchase a wireless transmitter from your Roland dealer and connect it to the OUTPUT sockets on the FR-7/FR-5.

- (1) Turn down the output volume of the receiving audio device.
You can also simply switch it off.
- (2) Connect the FR-7/FR-5's OUTPUT sockets to the external audio device using two 1/4" guitar cables.
Note: You can also connect headphones to the PHONES socket, in which case you do not need to establish an audio connection.
- (3) Press the FR-7/FR-5's **POWER** button (it lights) to switch it on.
The  icon informs you that the FR-7/FR-5 runs on the battery (it also indicates the battery's status).
- (4) Switch on the receiving audio device.
- (5) Start playing (see "First steps" on page 17).

–To switch off your system–

- (6) Turn down the output volume of the receiving audio device or switch it off.
- (7) Press the FR-7/FR-5's **POWER** button again so that it goes dark.

If you are using the FBC-7

If the FR-7/FR-5 is powered by the supplied FBC-7 unit, proceed as follows:

- (1) Connect the FR-7/FR-5 to the FBC-7 using the supplied 19-pin cable.
- (2) Connect the FBC-7's AC INLET socket to a wall outlet that meets the specifications (see p. 81).

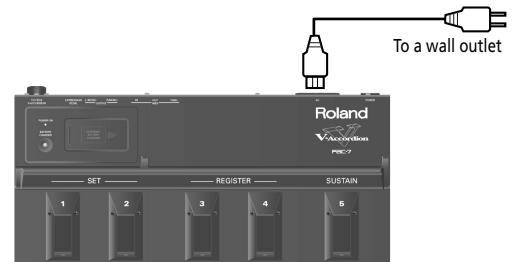

The FBC-7 should only be connected to a power source of the type marked on the bottom of the unit. For details on the power consumption, please refer to page 81.

- (3) Turn down the output volume of the receiving audio device.
You can also simply switch it off.
- (4) Connect the FBC-7's OUTPUT sockets to the external audio device (amplifier, mixing console, etc.). Though you can also use the FR-7/FR-5's OUTPUT sockets, doing so is probably only a good idea if you are working with a wireless transmitter. Using the FBC-7's OUTPUT sockets indeed means that you only need one connection between the FR-7/FR-5 and the FBC-7.
- (5) Press the FBC-7's **POWER ON** button to switch it on.

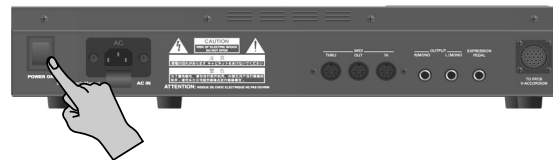

The POWER ON indicator on the FBC-7's top panel lights red.



- Press the FR-7/FR-5's **POWER** button (it lights) to switch it on.



The  icon in the display means that the FR-7/FR-5 is powered by the FBC-7.





- Switch on the receiving audio device.
- Start playing (see "First steps" on page 17).

—To switch off you system—

- Turn down the output volume of the receiving audio device or switch it off.
- Press the FR-7/FR-5's **POWER** button again so that its indicator goes dark.
- Switch off the FBC-7.



Listening to the demo songs

One of the most striking aspects of your V-Accordion may be that it can play all by itself! It contains indeed a series of demo songs that illustrate its wide variety of sounds and applications. Here is how to listen to the demo songs:

- Switch on the FR-7/FR-5.
See "Switching the power on and off" on p. 15. The display now looks more or less as follows:

- If necessary, use the SET   buttons to select another demo song.
- Use the **VOLUME** knob to change the volume if it is too loud or too soft.
Note: All demo songs are copyright ©2004 by Roland Europe. Public performance or recording of these songs is prohibited.
- Press **EXIT/JUMP** (or SET  and  simultaneously) to leave the demo mode.

Let us agree to call this page the "Main page".

Note: If you like, you can program a short message that is displayed each time the FR-7/FR-5 is switched on.

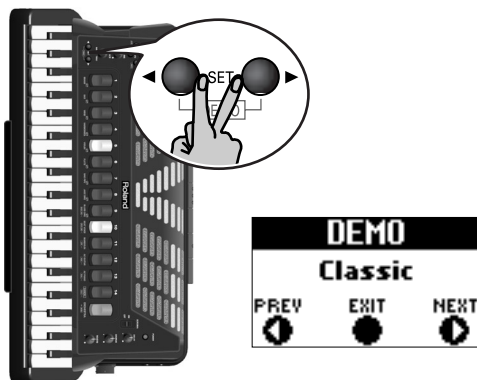
- Simultaneously press and hold SET  and  to jump to the following display page:



Playback starts automatically with the first demo song (there are 17 demo songs in all).

First steps

The sections of your FR-7/FR-5

Before showing you how to use the FR-7/FR-5, let's briefly look at the various "sections" of your instrument, as that will help you understand how your V-Accordion works.

The FR-7/FR-5 is a "virtual" accordion. That term was borrowed from synthesizers that recreate the sounds of other synthesizers using a different technology (hence the term "virtual analog synthesizer", for example).

The FR-7/FR-5 recreates the sounds of various accordion instruments (the "virtual" part) and can even generate orchestral sounds, like trumpet, flute, etc. (the **synthesizer** part).

The sections outlined in the illustration to the right contain several functions you can set. Let us agree to call those functions "parameters".

The parameters allow you to change certain aspects of the FR-7/FR-5's sound: you can select a French musette, an Italian accordion, etc., specify how strongly the virtual reeds should be detuned, add digital effects and more. Each section has its own parameters, so that you can fine-tune your sounds until you really like the entire accordion sound. You can save your settings and select them each time you want to play a given piece. There is thus no need to set the parameters time and again.

The various sections are combined into "Sets". Why is that? Because that way, you only need to select one memory (the Set) in order to save and recall the settings of all sections.

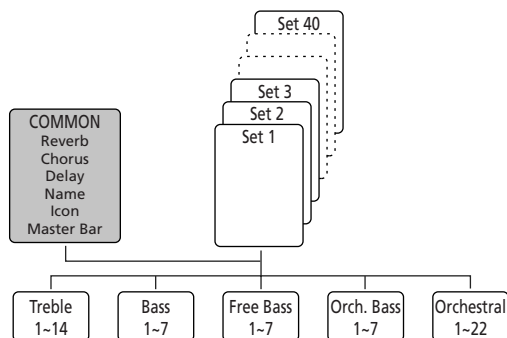

There are 40 Set memories that already contain useful settings right out of the box. But you can replace them with your own settings. (And if 40 Sets are not enough, you can archive and load new sets via MIDI, see page 75).

Sets are like the trunk of a car that contains several instruments (bandoneon, musette, etc.). The instruments themselves can be recalled via the registers.

There are 14 Treble memories, 7 Bass, Free Bass and Orchestra Bass registers and 22 Orchestra registers per Set. Except for the Orchestra sounds, the registers *can* behave like on an acoustic accordion, i.e. they allow you to change the footage combinations.

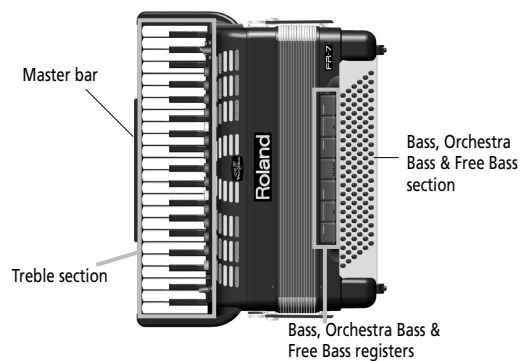

If you are really into programming, however, you could also assign completely different instruments to each register, in which case a Set becomes a container (the aforesaid car trunk) for a variety of accordion sounds.

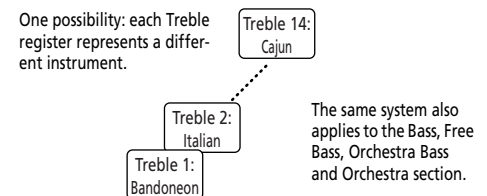

Another advantage of the Set structure is that it allows you to reconfigure the three digital effects processors (Reverb, Chorus, Delay) whose settings always apply to all sections.

O, and... the Sets can be selected with the SET ◀▶ buttons on the FR-7/FR-5 and the SET (1, 2) footswitches on the FBC-7 (if it is connected to the FR-7/FR-5).

Selecting Easy or Full mode

At first, the FR-7/FR-5 is configured to start up in "Easy" mode. In that mode, only the main parameters can be selected. It has the advantage that you do not feel overwhelmed by the FR-7/FR-5's possibilities. The downside, however, is that there are certain (albeit rather specialized) parameters you cannot even select.

To use the full potential of your FR-7/FR-5, you need to select "Full" mode:

- (1) Switch on the FR-7/FR-5.

See "Switching the power on and off" on p. 15. The display now looks more or less as follows:



Let us agree to call this page the "Main page".

- (2) Press and hold the **EXIT/JUMP** button until the display looks as follows:

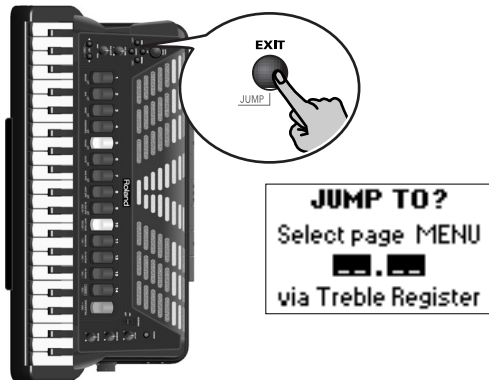

- (3) Press registers **8** and **2** to jump to the following page:

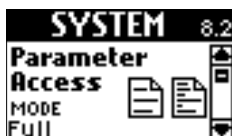

- (4) Press the **DATA/ENTER** knob.
- (5) Rotate the **DATA/ENTER** knob or press the **UP/DOWN** buttons to select either "Full" (show all parameters) or "Easy" (show only the main parameters).

- (6) Press **EXIT/JUMP** to return to the main page.

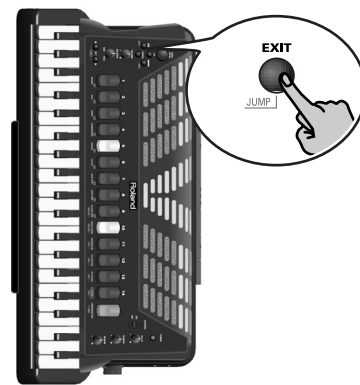

The FR-7/FR-5 asks you whether you want to save your changes:

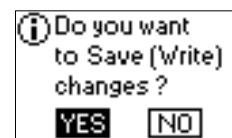

"YES" is selected by default. To save your changes, proceed as described below. (If you don't want to save them, **turn** the **DATA/ENTER** knob to select "NO", then **press** the **DATA/ENTER** knob.)

To save your changes:

- (7) Press the **DATA/ENTER** knob. The display now responds with:



Note: The GLOBAL page shows all parameters that are saved to the Global memory (there is only one such memory).

- (8) Press the **MENU/WRITE** button to save your changes. The display briefly shows a confirmation:



Note: If you selected "NO", the edited Global settings will be used until you switch off the FR-7/FR-5 (or change them again).

About the Main page

You may have realized by now that, with the exception of the display as well as the additional buttons and knobs, the FR-7/FR-5 looks like a conventional accordion. The display contains important clues about the settings that are currently in effect.

What's shown in the display depends on the function you select. When you switch on the FR-7/FR-5 or if you press the [EXIT/JUMP] button several times, the Main page appears. In some cases, the Main page may also reappear automatically after changing a parameter. That page must be displayed whenever you wish to play the FR-7/FR-5 without changing any of its "internal" settings.

A typical Main page display looks like this:

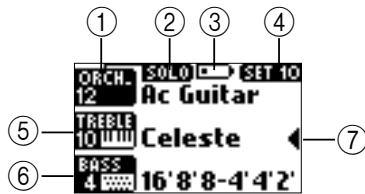

The exact contents depend on the Set that is currently selected and on how the various sections and performance functions are set. The ①~⑧ fields, however, are always there:

- ① Selected Orchestra register (here "12").
- ② Orchestra mode.
- ③ Power source (here the battery).
If you are working with a battery, this field also indicates the remaining battery power.
- ④ Number of the currently selected Set.
- ⑤ Selected Treble register (here "10").
- ⑥ Bass, Free Bass or Orchestra Bass register (here "4").
Only one of the two available Bass sections (Free Bass or Bass) can be active at any one time.
- ⑦ Part Select indicator. It tells you whether the Treble keyboard plays the accordion or orchestral sound.

Note: The information shown in the display may change when you rotate a knob or press a button. In such cases, however, the Main page reappears after a few seconds.

Touring the FR-7/FR-5's sections

It's time we put the FR-7/FR-5 through its paces, because that's what you purchased it for. We'll work section by section.

Treble section

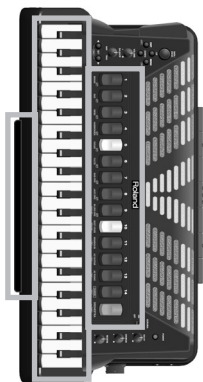

The Treble section can be played using the 41-key "piano" keyboard.

The sound it produces is determined by the register (1~14) you pressed last. This section can be used as "accordion", to play an orchestral sound or both.

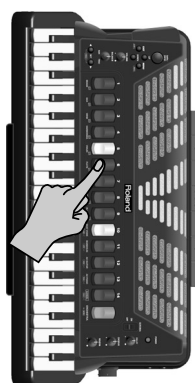

- (1) Connect the FR-7/FR-5 (if necessary) and switch it on. See pages 14 and 15.
- (2) Grab the FR-7/FR-5, press a Treble register and start playing on the "piano" keyboard. Though the FR-7/FR-5 is an electronic musical instrument, it only produces sound if you move the bellows. As long as you don't move the bellows, you hear nothing at all (like on an acoustic accordion).
Note: When the FR-7/FR-5 is controlled via MIDI, there is no need to move the bellows.
- (3) Press one of the registers to change the sound. The display briefly confirms your setting and indicates which footage you selected.



These indications refer to the octaves (vertical direction, ) and the number of slightly detuned reeds that are used (horizontal direction, ). The detuned reeds are only available for the central register (8').

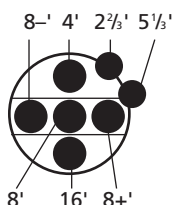

Black dots mean that the Cassotto function (see p. 41) is off, hollow dots mean that the Cassotto function is on. Here is what the registers and display indications mean (bear in mind that the dots can either be black or white):

Treble registers					
1		Bassoon	8		Master
2		Bandon	9		Musette
3		Cello	10		Celeste
4		Harmon	11		Tremolo
5		Organ	12		Clarinet
6		Accord	13		Oboe
7		Violin	14		Piccolo

On the Main page, the number of the selected register appears in the TREBLE field:



- (4) If you think the sound is too loud or too soft, you can change the setting of the **VOLUME** knob.

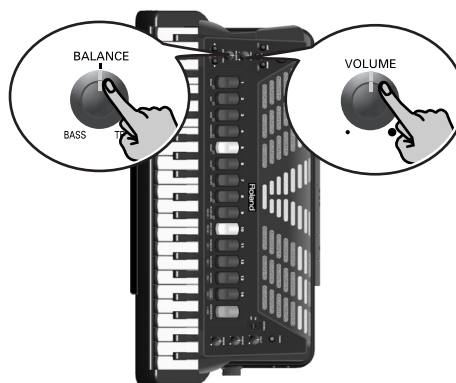

- (5) If you still can't hear the Treble notes, set the **BALANCE** knob to the center position. This knob is used to set the balance between the Treble and Bass registers. When it is turned all the way to BASS, the Treble section is inaudible. When you change the Balance setting, the display briefly confirms your setting:



- (6) Use the SET ◀▶ buttons to select another Set and again play a few notes.

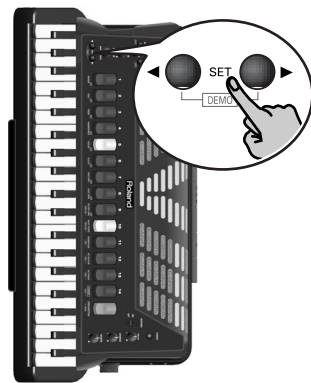

The number of the selected Set is shown in the upper right corner of the display. Note that you can also use the FBC-7's SET footswitches to select Sets.



■ Using the Sordina

The **SORDINA** switch allows you to attenuate the sound (make it softer). On an acoustic accordion, this closes the wooden resonance chamber inside the instrument.

The FR-7/FR-5 simulates this effect electronically (it contains not a single reed!).

When you switch on the Sordina, the display briefly confirms your selection:

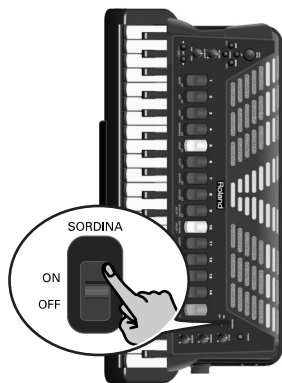

Note: The Sordina only applies to the Treble section.

Note: If you add an organ sound (8A~9B) to the Treble register (using the Orchestra section), the Sordina function is no longer available. Organ sounds indeed use a Rotary effect that blocks the Sordina function (in order to add the modulation of an organ speaker cabinet). You can use aftertouch, to switch between the fast and slow Rotary speeds. "Aftertouch" refers to the fact that you press a key even further down after playing a note.

■ Using the FR-7/FR-5's digital effects

While playing on the Treble keyboard, you may have noticed that the accordion sounds were enhanced by effects (probably reverb). It may also have struck you that the effects change whenever you select a different Set. That's because the effect settings are part of the parameters you can save for each Set independently.

The FR-7/FR-5 contains 3 digital effects:

Reverb: This effect gives the impression that you are playing in a concert hall, a church or a room. It adds "depth" to the sound.

Chorus: This effect gives the impression that several instruments of the same type are playing at the same time (it is similar to detuning several reeds of a register).

Delay: This effect creates echoes, i.e. repetitions. Short intervals (called "slapback") create an effect similar to reverb. Longer intervals, on the other hand, create real echoes.

The **DELAY**, **CHORUS** and **REVERB** knobs allow you to set the volume of these three effects. Turn them all the way towards the left (the small dot) if you don't need the effect in question.

Turn them towards the right (the big dot) to increase the effect volume.



Note: The settings of these knobs apply to all sections and all Sets.

After familiarizing yourself with the FR-7/FR-5's parameters, you will realize that these knobs should only be used as a last resort (i.e. on stage). You can indeed program the effect level for each section separately, so that the **DELAY**, **CHORUS** and **REVERB** knobs can be left in the center position, while the amount of effects changes with every Set you select.

Note: In certain cases, changing the knob position of an effect may not produce any audible result. This is due to the Send Level settings of the sections (see page 42, for example). It means that a given section was programmed not to send any signal to the effects processor in question. Even setting the corresponding knob to the maximum therefore produces no change.



Bass section

The Bass section can be played via the "Stradella" buttons.

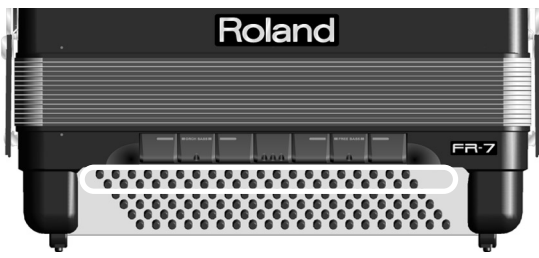

The buttons in this section allow you to play *both* bass notes *and* chords. The chords use the (sound) register selected for the Bass section – hence the name of this section. The "real" bass notes are assigned to the two circled rows. The remaining buttons are used to play chords.

The FR-7/FR-5 is supplied with *several reference caps* (concave and with lines) designed to help you locate the bass and chord buttons without looking at them. At the factory, three caps are installed on the black buttons in the following illustration. Feel free to remove them and to slide them over other buttons if that feels more comfortable.

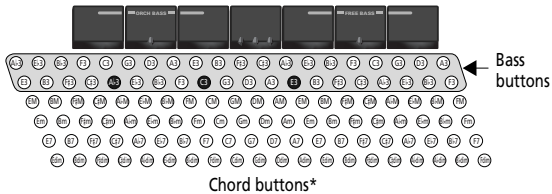

(*) This can be changed to 3 bass and 3 chord rows. See "8.5 Bass & Chord Mode" on p. 61.

Here is what the caps look like:

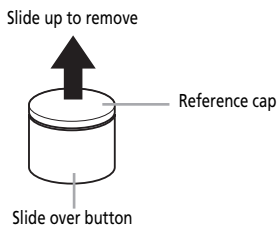

The sound the Bass section produces is determined by the register you pressed last. This section can be used as "accordion", to play orchestral sounds, or both.

- (1) Connect the FR-7/FR-5 (if necessary) and switch it on.
See pages 14 and 15.
- (2) Grab FR-7/FR-5, press a register and start playing on the Bass (button) keyboard. Though the FR-7/FR-5 is an electronic musical instrument, it only produces sound if you move the bellows.
- (3) Press another register to change the sound.



The display briefly confirms your setting and indicates which footage you selected:

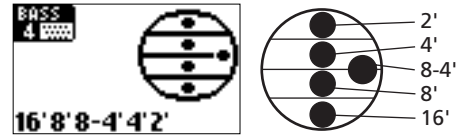

These indications refer to the octaves (vertical direction) and the number of slightly detuned reeds that are used (horizontal direction).

On the Main page, the number of the selected register appears in the display's BASS field:



Note: You can also press several registers simultaneously to get a fuller sound.

- (4) If you think the sound is too loud or too soft, you can change the setting of the **VOLUME** knob.

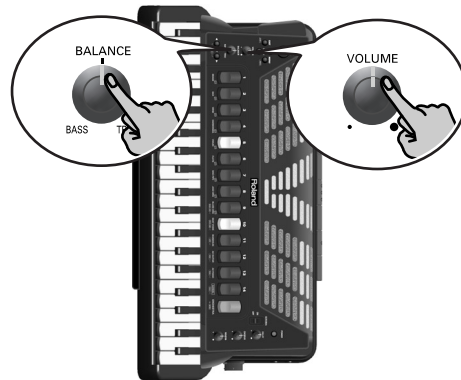

- (5) If you still do not hear the bass and chord notes you are playing, change the **BALANCE** knob's setting. This knob is used to set the balance between the Treble and Bass registers. When it is turned all the way to TREBLE, you won't be able to hear the Bass section.
- (6) Use the SET **◀▶** buttons to select another Set and again play a few notes.

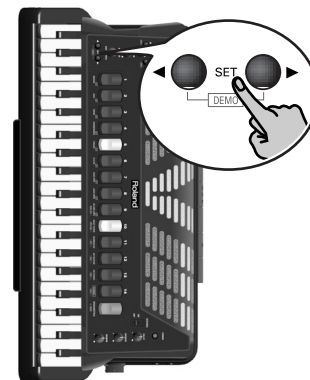

The number of the selected Set is shown in the upper right corner of the display. You can also use the FBC-7's SET footswitches to select Sets.



■ Playing in Free Bass mode

The FR-7/FR-5 also provides a Free Bass mode, which is chiefly used by professionals who prefer to play the left-hand notes (Bass section) differently. You may never need it, but if you wish to experiment with it...

Note: See page 62 for how to select the note system for Free Bass mode. That setting is shared by all Sets.

- (1) Simultaneously press the three registers labeled "FREE BASS".



The display now briefly responds with:

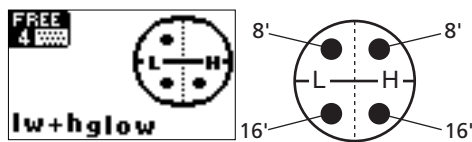

"L" refers to the low range and "H" to the high range. The exact ranges depend on the FREE BASS mode you selected. See also the illustration on page 62 where the high range is indicated by means of black buttons, and the low range by means of white buttons.

Note: See page 62 for the assignment of the bass buttons to the available Free Bass notes.

- (2) Use the Bass registers to select another registration (if necessary).
- (3) Press the three FREE BASS registers again to return to the normal Bass mode.

Note: You can add an orchestral sound to the Bass or Free Bass section. See page 27 for details.

■ Using the FR-7/FR-5's digital effects

While playing on the Bass keyboard, you may have noticed that the accordion sounds were enhanced by effects (probably reverb). It may also have struck you that the effects change whenever you select a different Set.

The FR-7/FR-5 contains 3 digital effects that apply to all sections. See page 21 for details and how to set them.

Note: In certain cases, changing the knob position of an effect may not produce any audible result. This is due to the Send Level settings of the sections. It means that a given section (or all sections) was programmed not to send any signal to the effects processor in question. Even setting the corresponding knob to the maximum therefore produces no change.

Using the orchestral sounds

Your FR-7/FR-5 also contains PCM sounds (samples) of various instruments that are not related to accordion sounds. Those sounds allow you to expand your musical endeavours without using external MIDI devices. Of course, you are free to add external MIDI tone generators to your setup and to control them from your FR-7/FR-5. See page 66 for details. Let us first look at how to use the on-board orchestral sounds, however.

The FR-7/FR-5's Orchestra functionality actually comprises two sections: one for the Treble keyboard (called "Orchestra") and another for the Bass buttons (called "Orchestra Bass").

You can specify for each keyboard whether the orchestral sounds should be used alongside the accordion sounds (so that each note or chord you play results in a combination of accordion + instrument sound) or in isolation (no accordion).

Orchestral sounds for the Treble section

Note: Only one orchestral sound can be selected at any one time.

- (1) Press the **ORCHESTRA** register.

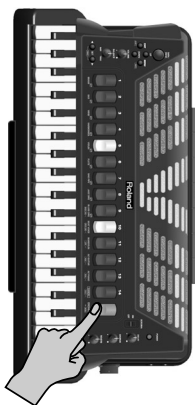

The display now responds with:



The arrow moves from the TREBLE to the ORCH line. By pressing a register, you therefore select an Orchestra sound.

Let us quickly analyze the information you get on this page:

- "SOLO" means that the mode of the same name is currently selected (there are four different modes, see below).
- "CANCEL" means that the Orchestra part is not active. If you play on the Treble keyboard, you only hear the Treble accordion sound. To activate the Orchestra part at this stage, you need to select a sound (see below).
- The TREBLE field contains a keyboard icon. It means that the Treble keyboard is assigned to the Treble accordion part. The ORCH field, on the other hand, contains no keyboard icon, which confirms the "CANCEL" message.
- The sound name ("Celeste") refers to the register that was selected for the TREBLE section's accordion part.

- (2) Press one of the registers to select the desired Orchestra sound (see the names below the Treble registers).

This activates the Orchestra part. The display now changes (the sound name may be different on your instrument):



Compare the information discussed above with what you see now:

- There's a sound name next to the ORCH field ("Ac Guitar"). That's the sound you'll hear when you play on the Treble keyboard.
- The keyboard icon has moved from the TREBLE to the ORCH field.

The 22 available Orchestra sounds and associated registers are:

Orchestral Treble sounds			
1A	Trombone	7A	HighLand*
1B	Trumpet	7B	Zampogna*
2A	Tenor Sax	8A	PercOrgan
2B	Alto Sax	8B	JazzOrgan
3A	Clarinet	9A	RotOrgan
3B	Oboe	9B	TremOrg
4A	Harmonica	10	ScatVoice
4B	Mute Harm	11	Mandolin
5A	Violin	12	AcGuitar
5B	Pizzicato	13	AcPiano
6A	Flute		
6B	Pan Flute		

[*] See "About the "HighLand" and "Zampogna" sounds" on p. 25.

The first nine registers allow you to select two sounds ("A" and "B"). To select a "B" sound, press the corresponding register again.

If you select a "B" sound (5B "Pizzicato", for example), then press another register (12 "AcGuitar") and again the first register (5), the FR-7/FR-5 automatically recalls the "B" sound ("Pizzicato"). This "configuration" is retained until you switch the FR-7/FR-5 off. If you need the 5A "Violin" sound at this stage, you need to press register **5** once more.

The display briefly confirms your selection and shows both the name of the sound you selected and the number of the register you pressed:



(3) Play a few notes on the Treble keyboard.

The Treble keyboard is **velocity sensitive**. The volume and timbre of the notes played by the Orchestra part depend on how hard/fast you press the treble keys (for sounds 11, 12 or 13).

Note: The Treble accordion does not respond to velocity information generated by the keyboard. You can, however, vary its volume and timbre by pressing/pulling the bellows harder and softer (like on a "real" accordion).

The Treble keyboard also generates **aftertouch** messages. "Aftertouch" refers to the fact that you press a key even further down after playing a note. For some orchestral sounds (guitar, flute, etc.) as well as for the Treble accordion section, this effect allows you to bend the pitch down (temporarily lower the note). If you select an organ sound, aftertouch can be used to switch between the fast and slow Rotary effect speeds.

Note: This aftertouch effect applies to all notes that are sounding simultaneously. If you play a chord and then only press down one key of the chord's constituent notes, all notes are bent by the same amount. (MIDI buffs call this "channel aftertouch".)

■ About the "HighLand" and "Zampogna" sounds

Your FR-7/FR-5 contains two bagpipe-instrument sounds, one called "HighLand", the other called "Zampogna". The instruments on which those sounds are based use one or several drone notes over which the melody is played.

To recreate the same sensation on the FR-7/FR-5, the lowest octave on the Treble keyboard is assigned to the drone notes when you select one of these sounds:

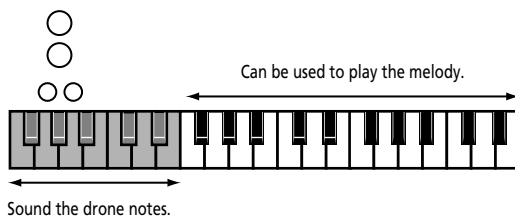

Here is how the drone function works:

- If you press a single gray key (see the illustration), only that note is held. You can release the key immediately after playing the note – it will be held indefinitely.
- If you press two (or more) keys simultaneously, those notes are held (the drone function is polyphonic).

- To switch off the currently sounding drone note(s), either press another key in the gray area (switch to another drone note) or press the key(s) of the sounding drone notes again to stop the drone.

Note: This drone system is only available for the "HighLand" and "Zampogna" sounds.

■ Selecting the Orchestra mode

Depending on the settings of the Set you selected, the Orchestra part may sound together with the Treble accordion section. That's because there are four ways in which the Orchestra section can be combined with the Treble accordion section.

If the Orchestra part is off (set to CANCEL), the Master bar always recalls the Treble register selected with "7.8 Master Bar Recall" (page 59).

After selecting one of the modes (DUAL, HIGH, LOW or SOLO) and switching on the Orchestra part (CANCEL off), the Master bar allows you to switch the Orchestra part on and off. In SOLO mode, this means that you alternate between the Treble and Orchestra parts.

SOLO [14]: When you switch on the Orchestra section (see step (2) above), you only hear the Orchestra instrument sound. Press **CANCEL** to return to the Treble accordion sound.

DUAL [13]: The Orchestra sound is added to the Treble accordion, so that each note you play sounds like an accordion and the selected instrument playing in unison.



Just as a reminder: here, both the ORCH and TREBLE fields contain a keyboard icon to indicate that they sound simultaneously.

HIGH [12]: Now it becomes a little more complicated – but very interesting indeed. If you select this mode and play just one note, it is sounded by the orchestral sound. If you keep holding that key while pressing another (lower) key to its left, the upper note is played by the Orchestra sound. Lower notes, however, are played by the Treble accordion sound. This is perfect for situations where you need to play chords and a solo line using different sounds. Something like this:

Played by the Orchestra sound

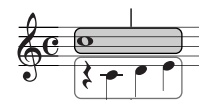

Played by the accordion

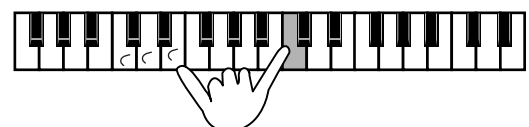

LOW [11]: This is the opposite of HIGH and can be used in situations where the melody (or counter-melody) lies above the notes you wish to hold.

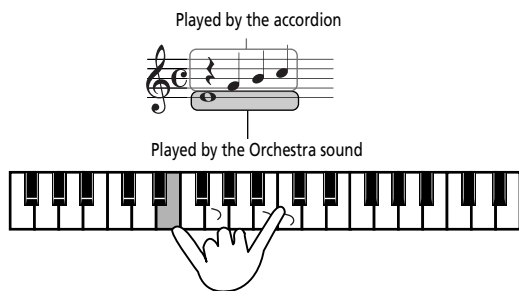

- (4) While holding down the **ORCHESTRA** register, press **[11]**, **[12]**, **[13]** or **[14]** to select the desired mode.

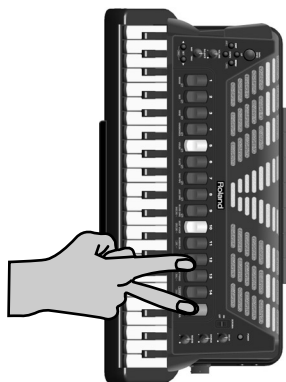

The display briefly confirms your selection (only one of the following messages is actually displayed):

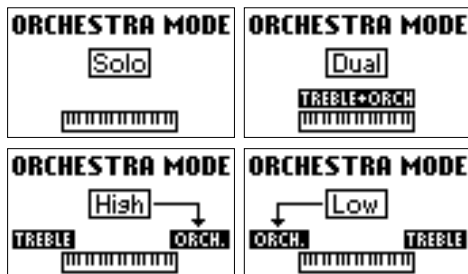

- (5) Again play a few notes and listen to the result.
Note: The Orchestra mode setting is saved to a Set (see p. 43). The saved mode is recalled when you activate the Orchestra part.

■ **Quickly adding and muting the Orchestra sound**
After activating the Orchestra section and selecting a mode, you can play certain phrases using the accordion sound and then add the selected Orchestra sound to it when you play it again.
The following switches the Orchestra part on and off in DUAL, HIGH or LOW mode. The Treble accordion part goes on sounding, however.

- (6) Press the Master bar that protrudes from underneath the Treble keyboard to switch the Orchestra part on or off.

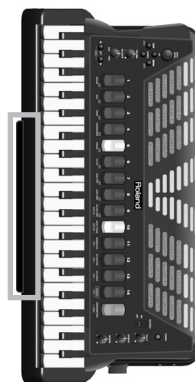

The display now looks as follows (same system for the HIGH and LOW modes):



Note which field contains a keyboard icon, then press the Master bar again and look at the display. Play a few notes to understand what happens.

■ **Setting the volume of the (Treble) Orchestra sound**

There may be times (in DUAL, HIGH or LOW mode) when the ORCHESTRA sound is too loud or too soft with respect to the Treble accordion sound. In that case, you can change its volume:

- (7) Press the **DOWN** button once.

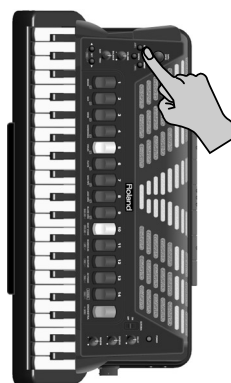

- (8) Use the **DATA/ENTER** knob to set the desired value.
This is actually a balance parameter with a setting range of -30~"Std"~+30. "Std" means that the Orchestra part uses its "normal" volume. Negative values (-) make the Orchestra part softer, while positive values (+) make it louder.
You can save the new value (and the remaining changes you make). See page 77.
- (9) Return to the Main page by pressing **EXIT/JUMP**.

■ Switching off the Orchestra part

To return to a state where only the Treble accordion section sounds:

- (10) Press the **CANCEL** register. Now, FR-7/FR-5 is a normal accordion again.
To activate the Orchestra part again, perform steps (1) and (2) on page 24.

Orchestral sounds for the Bass section

The Orchestra Bass part can be added to either the Bass or the Free Bass section (depending on which one is currently active, see page 22). There are no clever modes (DUAL, SOLO, etc.) here, nor can you alternate between the Bass accordion and Orchestra Bass sections using the Master bar.

Furthermore, the Orchestra Bass part does what its name implies: it **only applies to the bass rows** (the ones closest to the bellows) and has no effect on the chord buttons.

- (1) Simultaneously press the three registers labeled "ORCH BASS".



The display now briefly responds with:

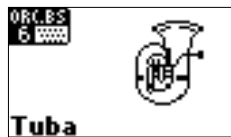

- (2) Use the Bass registers to select the desired sound.

Orchestra Bass sounds			
1	Acoustic	5	Picked
2*	Bowed*	6*	Tuba*
3	Fingered	7	Tuba Mix
4	Fretless		

Note: The dynamics of sounds marked with an asterisk (*) can only be controlled by bellows movements. Those sounds are not velocity sensitive. For the other sounds, see also "8.11 Orchestral Bass Touch" on p. 63.

Note: The numbers shown in the illustration above do not appear on the registers themselves. They have been added for your reference.

■ Setting the volume of the Bass Orchestra sound

There may be times when the Orchestra Bass sound is too loud or too soft with respect to the Bass/Free Bass accordion sound. In that case, you can change its volume:

- (3) Press the **DOWN** button twice.

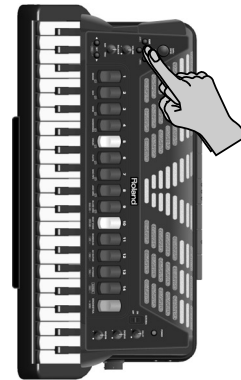

The display now responds with:



- (4) Use the **DATA/ENTER** knob to set the desired value.
This is actually a balance parameter with a setting range of -30~"Std"~+30. "Std" means that the Orchestra Bass part uses its "normal" volume. Negative values (-) make the Orchestra Bass part softer, while positive values (+) make it louder.
You can save the new value (and the remaining changes you make). See page 77.
- (5) Return to the Main page by pressing **EXIT/JUMP**.

■ Switching off the Orchestra Bass part

- (6) Press the three ORCH BASS registers again to return to the normal Bass mode.

Other practical functions

After looking at the accordion and Orchestra functions, we will now leave the "acoustic" (but virtual) realm and look at the first "purely electronic" functions of your FR-7/FR-5.

Your FR-7/FR-5 is what we call a virtual instrument. Though its physical appearance is similar to that of its acoustic ancestor, it is based on an altogether different concept (technology) – and it can do a lot more. In this section, we will look at functions that may be new to you but may come in handy once you know what they do and how they work.

General remark

The functions discussed here can be selected via the front panel, because we figured that you might need them more often than the other parameters.

The changes you make here are not saved automatically – and there is no "Do you want to save" page to remind you that your changes will be lost if you don't save them. That's because these shortcuts are mainly intended for temporary adjustments. If you want to keep them forever (or until you change them again), you must save them (see p. 77).

The functions discussed here can also be set using the FR-7/FR-5's MENU.

Pitch-related functions

■ Transpose

The FR-7/FR-5 contains a Transpose function that allows you to change the key of the music you are playing. The advantage of this system is that you can play a song in E major (for example), while using the fingering of the C major scale (for example). This may come in handy when you are used to playing a given song in one key and suddenly need to play it in a different key.

Let's look at an example:

This is what you play...

...and this is how it sounds.

- (1) While the Main page is displayed, press the **[UP]** button once.

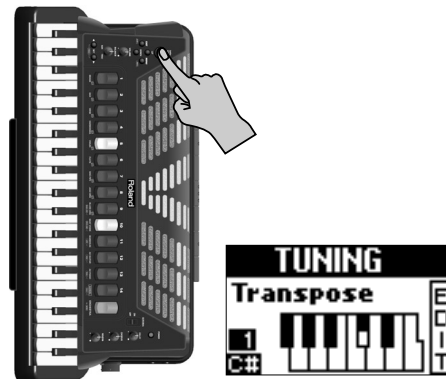

- (2) Use the **[DATA/ENTER]** knob to select the key your music should sound in.
The note indication ("C#" in the example above) always refers to the C key, which may make it difficult for you to transpose to F# (for example) while playing in Bb. We therefore recommend to use the value as your main guide, because it represents the interval. This can be calculated as follows:
 - What key does the song use? (This is your "0" value.)
Example → E major
 - In what key do you want to play?
Example → C major
 - How many semitones do you need to "shift" the notes?
Example → [C#, D, Eb, E] = 4 up, so "4".
- (3) Press **[EXIT/JUMP]** to return to the Main page.

■ Musette Detune

Now here is a parameter that already hints at the power of the FR-7/FR-5's virtual technology... You probably know that an accordion's 8' Treble register may consist of 2 or even 3 reeds that are usually tuned apart to provide a richer sound (accordionists call it the "musette effect"). One reed is tuned slightly above, the other slightly below the correct pitch (and the third, if available, is tuned "properly").

Tuning those reeds is a specialist job and usually not performed by accordion players themselves.

On the FR-7/FR-5, however, "tuning" the "reeds" (that do not really exist) is a matter of turning the **[DATA/ENTER]** knob.

- (1) While the Main page is displayed, press the **[UP]** button twice.

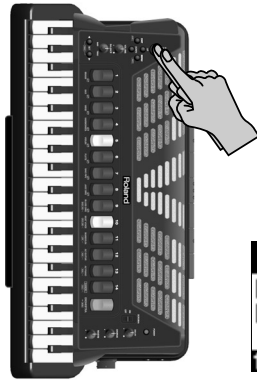

- (2) Use the **[DATA/ENTER]** knob to select the a different tuning for the Treble reeds.
The possibilities are: Off (no detune), Dry, Classic, F-Folk, American L, American_H, North Eur, German L, D-Folk L, Italian L, German H, Alpine, Italian H, D-Folk H, French, Scottish.
- (3) Press **[EXIT/JUMP]** to return to the Main page.

■ Scale (Tuning)

Almost each music culture has its own accordion variety. Arabic, Indonesian and other musical cultures do not use the equal temperament that is favored in Europe, the Americas, etc.

The FR-7/FR-5 also features a "Scale" parameter that allows you to select the tuning system that best fits the music you want to play. If the tuning system you need is not among the factory settings, you can program it yourself (see p. 38) and then select it here.

Note: See "1.1 Master Tune" on p. 38 for how to change the FR-7/FR-5's reference pitch (i.e. "really" tune it).

- (1) While the Main page is displayed, press the **[UP]** button three times.

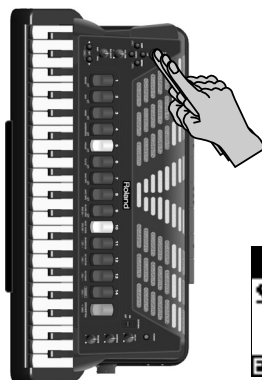

- (2) Use the **[DATA/ENTER]** knob to select the a different tuning system.
The possibilities are:

Equal (Off): This tuning divides the octave into 12 equal steps (intervals).

User 1~3: These settings refer to the tuning systems programmed by yourself (or someone else). See "1.4 Scale Edit" on p. 38 for details.

Arabic 1 & 2: As the name implies, these two settings refer to Arabic tuning systems. Select "1" to lower the E and B notes by a quarter tone (-50 cents). "2" represents a scale where the E and A are tuned down a quarter tone.

Just Major: This is a classical (western) tuning that resolved the ambiguity of fifths and thirds. Quite beautiful sonorities are produced with chords, but the scale is unbalanced, so it is not well-suited for melodies.

Just Minor: This is a Just scale for pieces in minor keys.

Pythagorean: This method of tuning was invented in ancient Greece. It resolves the ambiguity of fourths and fifths. Though thirds are somewhat imperfect, melodies sound clearer.

Mean-Tone: A temperament that adds some compromises to the Just temperament and facilitates transposition.

Werckmeister: A combination of the Mean Tone and Pythagorean temperaments, this tuning allows for playing in any key.

Kirnberger: As a result of improvements made to the Mean Tone and Just temperaments, it is relatively tolerant towards transposition and can be used to play in all keys.

Except for "Equal", you also need to specify the root/fundamental ("C" for major and "A" for minor) according to the key of the song to be played.

- (3) Press the **[DATA/ENTER]** knob to activate the "KEY" field (so that it is displayed in reverse).
- (4) Turn the **[DATA/ENTER]** knob to select the desired root note (C~B).
- (5) Press **[EXIT/JUMP]** to return to the Main page.

Volume-related functions

The three remaining "shortcuts" allow you to quickly change the balance of various sonic aspects.

■ Orchestra Volume and Orc. Bass Volume

These two parameters allow you to set the volume of the Treble and Bass Orchestra sections relative to the associated accordion part. See pages 26 and 27 for details.

■ Noise Edit (Valve & Button)

Here are two more "virtual" parameters. You will probably agree that electronic sounds must not only reproduce the basic timbre of an existing sound, but also the original instrument's behavior and typical "noises" in order to be perceived as authentic. In the case of a guitar that would be the sliding noise of the fingers. An accordion, on the other hand, produces mechanical valve and button noises (clicks) that cannot be suppressed on an acoustic instrument.

On the FR-7/FR-5, the volume of those noises can be changed if you think they are too prominent or too soft. Note that the parameters on this Jump page belong to two different MENU sections and are to be found on separate pages: "Valve Level" is a Treble parameter, "Button Level" is a Bass/Free Bass parameter.

- (1) Press the **DOWN** button three times.



- (2) Press the **DATA/ENTER** knob to select either "Valve Level" or "Button Level", depending on which parameter you want to set.
- (3) Turn the **DATA/ENTER** knob (or use the **UP**/**DOWN** buttons) to select the desired noise level (Off, -30~"Std"~+30).
A negative (-) value decreases the level of the selected noise parameter, a positive (+) value increases it. Select "Std" to return to the factory value and "Off" if you do not need the noise in question.
- (4) Press **EXIT/JUMP** to return to the Main page.

5. About the FBC-7

Your FR-7/FR-5 comes with an FBC-7 footswitch unit that doubles as power supply for your V-Accordion and also allows you to recharge a battery. If you purchased an FR-5, you must connect it to the FBC-7 (or purchase an optional battery). FR-7 users, on the other hand, can also play their instrument without connecting it to the FBC-7.

Using the FBC-7

When do you need the FBC-7?

- If you own an FR-5 and did not purchase an optional battery, you always need the FBC-7.
- If you want to select registers and Sets using the SET and REGISTER footswitches.
- If you want to use the SUSTAIN footswitch and possibly also an optional expression pedal.
- If you want to take advantage of the FR-7/FR-5's MIDI functionality. This may include starting and stopping an external arranger module, selecting other Style divisions, etc.
- If you do not use an optional wireless system and do not want to use excessively long audio cables that run from the FR-7/FR-5 to your amplifier or mixing console.
- If you need to recharge the (optional) battery.

Connecting the FBC-7

See page 15 for how to connect the FR-7/FR-5 to the FBC-7 and the FBC-7 to a wall outlet that matches its voltage.

The 19-pin cable can only be connected in one way, so you can't go wrong. Just be sure to align the protrusions on the jack with the corresponding holes on the FBC-7's and FR-7/FR-5's socket:

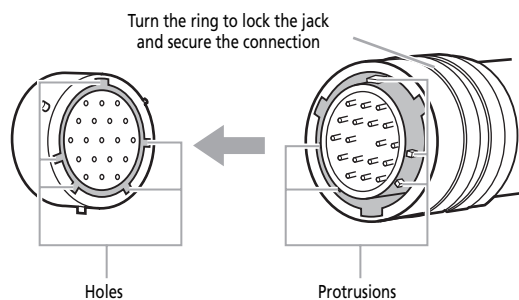

Using the footswitches

The FBC-7 has five footswitches that grant you even more flexibility:



Use the **SET** switches (1 and 2) to select Sets. The 1 switch allows you to select the preceding Set (e.g. Set 18 if you are currently using Set 19), while the 2 switch is used to select the next Set (e.g. 20 if you are currently using Set 19).

If you press 2 again after selecting Set 40, the FR-7/FR-5 jumps to Set 1. Likewise, if you press 1 after selecting Set 1, the FR-7/FR-5 jumps to Set 40.

The **REGISTER** switches (3 and 4) allow you to select Treble registers 1~14. They work the same way as the SET footswitches: 3 selects the preceding register, while 4 selects the next one. These footswitches are most effective when you combine them with the Link function (see p. 42), because that allows you to reconfigure the Bass/Free Bass and Orchestra sections simply by selecting another Treble register.

The **SUSTAIN** footswitch allows you to hold the notes of Orchestra sounds if that section is on. It also transmits CC64 messages via MIDI. If you assign it to another section (page 60), it only transmits MIDI messages on the channel of the selected section (Treble, Bass, Orchestra Bass, and Chord). Its main use is to generate legato notes for piano and similar sounds like on an acoustic or digital piano. Notes whose keys are pressed when you press the footswitch will be held until you release the SUSTAIN footswitch.

Connecting an optional expression pedal

You can also connect an optional EV-5 or EV-8 expression pedal to the EXPRESSION PEDAL jack. That pedal applies to the Treble Orchestra part only (again for the piano, mandolin and guitar sounds; these, by the way, are the only sounds whose expression cannot be controlled via the bellows). It allows you to create swell effects in much the same way as an organ or guitar player does.

The reason why the Treble and Bass sections do not respond to this pedal is that you can control their volume via the strength with which you press and pull the bellows (like on any accordion).

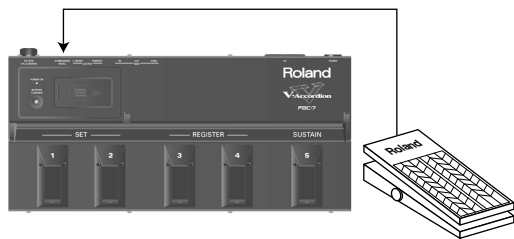

The expression pedal can be used to fade the Orchestra part in and out, which is probably most effective in DUAL mode (see p. 25). When the expression pedal is all the way up (heel down), the Orchestra part does not sound. Press the expression pedal down (toe down) to increase the Orchestra section's volume.

Note: The expression pedal can also transmit CC11 messages via MIDI. See page 74.

Charging the battery

The FR-7 comes with one rechargeable Ni-Mh battery that can be recharged when it is depleted. Such a battery is optional for the FR-5. If you decide to purchase one (to be able to play with a wireless system and no cables on stage), you should also read the following.

General remarks about the battery

- Be sure to dispose of used batteries in accordance with local regulations.
- First, read the precautions on page 9 and following.
- The FR-7's battery is fully charged (and installed in the FR-7's battery compartment). It can be used right away.
- Be sure to fully deplete the battery (wait until the FR-7/FR-5 turns off) before recharging it for the first time. It would actually be a good idea to repeat this the first three times to avoid the dreaded "memory effect".
- A fully charged battery should last about 8 hours (continuous use).
- When the battery is fully drained, the following message appears and the FR-7/FR-5 goes off:



Note: The FR-7/FR-5 contains an energy saving function that switches off the instrument when it is left unattended for more than 10 minutes. You may therefore have to switch it on again from time to time. You can specify how long the FR-7/FR-5 should wait before powering off automatically. See "8.8 Auto Power OFF" on p. 63.

- Never try to insert other batteries into the FR-7/FR-5 than the ones it came with (or suitable replacement batteries purchased from your Roland dealer). Only use "BP-24-45" batteries, part no. K2568101.



Warning: The battery body may become hot during and after charge. Handle it with care to avoid burns.

About the BATTERY CHARGER and EXTERNAL BATTERY CHARGER indicators

The FBC-7 has two buttons (**BATTERY CHARGER** and **EXTERNAL BATTERY CHARGER**) that light or flash in various ways to indicate the current status. Here is how to "decode" those indications:

- **Lights red:** The battery is being charged. Depending on the button that lights, this refers to the battery in the FR-7/FR-5 (BATTERY) or the battery attached to the FBC-7 (EXTERNAL BATTERY).
- **Lights green:** The battery is fully charged and can be used again.
- **Flashes yellow right away:** The charging operation cannot be started because the ambient temperature lies outside the 0°~40°C range. This is nothing to worry about: just take the FBC-7 to a place where the ambient temperature is acceptable, wait a little, and repeat the charging operation.
- **Flashes yellow after a while:** If the indicator first lights red and then starts flashing yellow after a while, the battery is overheating. Disconnect the FR-7/FR-5 (or the battery) from the FBC-7 and use the battery until it is depleted. Then, recharge it.
- **Flashes red:** The battery cannot be fully recharged, i.e. it takes more time than expected to reach full charge. If this happens once, wait at least half an hour and try charging it again. If the button again flashes red, the battery may have reached the end of its life cycle. Replace it with a new one if the button keeps flashing red.

Recharging the battery without removing it from the FR-7/FR-5

There is no need to remove the battery from the FR-7/FR-5 in order to recharge it. Recharging the battery takes $\pm 3\sim 5$ hours and is therefore not something you should do a few minutes before you intend to use the FR-7/FR-5.

- (1) Connect the FR-7/FR-5 to the FBC-7 using the supplied 19-pin cable.
- (2) Connect the FBC-7 to a suitable wall outlet.
- (3) Switch on the FBC-7 by pressing its **POWER ON** button (its red **POWER ON** indicator lights).
- (4) Press the **BATTERY CHARGER** button on the FBC-7.



The **BATTERY CHARGER** button now lights red.

- (5) Wait until the **BATTERY CHARGER** button lights green, then switch off the FBC-7 and disconnect the 19-pin cable from both the FBC-7 and the FR-7/FR-5.

Disconnecting the FR-7/FR-5 is only necessary if you do not want to use the FBC-7 during your next performance.

Note: You can use the FR-7/FR-5 while its battery is being recharged, provided you leave the V-Accordion connected to the FBC-7.

Recharging the battery on the FBC-7

The battery installed in the FR-7/FR-5's compartment can also be removed and recharged on the FBC-7 itself. That is more tedious, though and does not speed up the recharging procedure.

The main use for the method described below is therefore to recharge a spare battery (which is optional) while using the battery inside the FR-7/FR-5. If that is what you want to use the connector on the FBC-7 for, skip to step (7) below.



Warning: Before removing the battery, be sure to power off the FR-7/FR-5 (the blue indicator must be dark).

- (1) Switch off the FR-7/FR-5.
- (2) Prepare a coin.
- (3) Remove the cushion located between the Treble keyboard and the bellows.

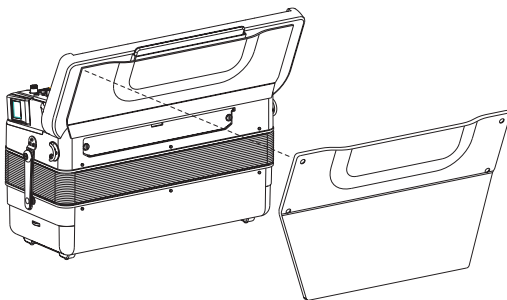

- (4) Use the coin to loosen the two screws of the compartment cover.

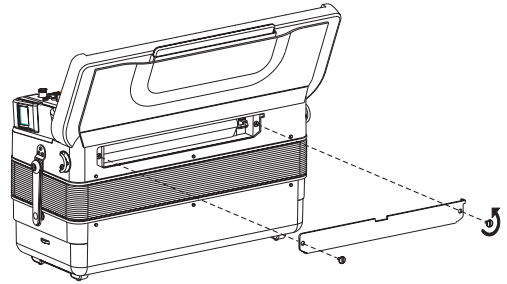

- (5) Remove the cover from the FR-7/FR-5's battery compartment.

Note: While the compartment cover is open, the FR-7/FR-5 cannot be switched on.

- (6) Pull the battery strip so that the battery protrudes a little from the battery case, and then remove the connector and take the battery out of the battery case.

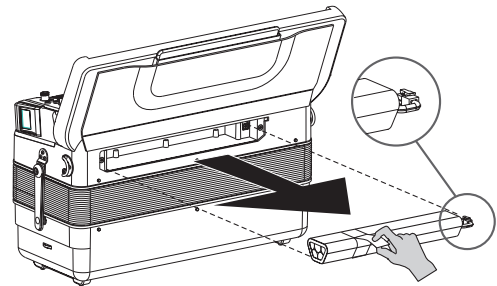

The battery is connected to the FR-7/FR-5 by means of a cable. You need to disconnect the cable from the battery by pressing the clip on the connector before fully removing the battery.

Note: Please pull the battery strip installed on the battery and take the battery out.

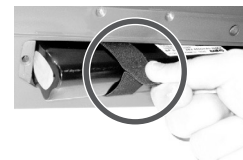

- (7) Slide the FBC-7's **EXTERNAL BATTERY CHARGER** cover to the right and remove it:

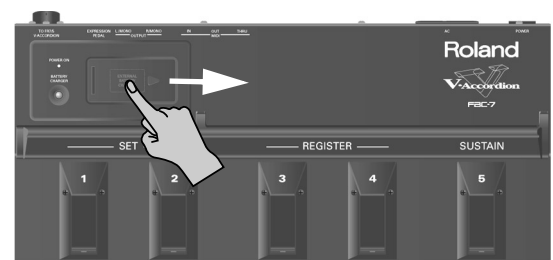

That portion on the FBC-7 now looks as follows (note the connector):

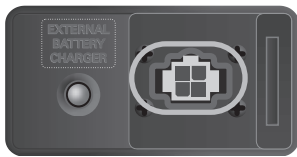

- (8) Connect the battery's cable to the charger's socket.

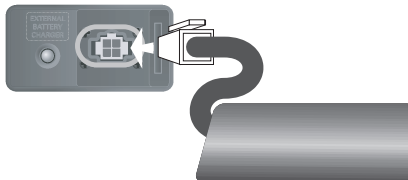

- (9) Slide the battery into the holder on the FBC-7.

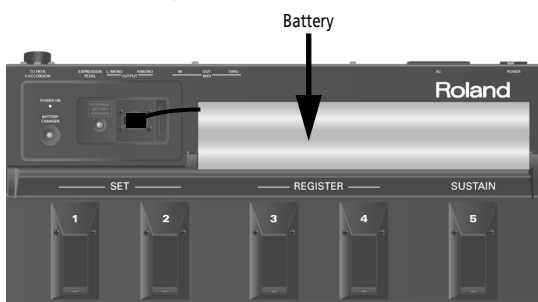

- (10) Connect the FBC-7 to a suitable wall outlet.
(11) Switch on the FBC-7 by pressing its **POWER ON** button (its red **POWER ON** indicator lights).
(12) Press the **EXTERNAL BATTERY CHARGER** button on the FBC-7.

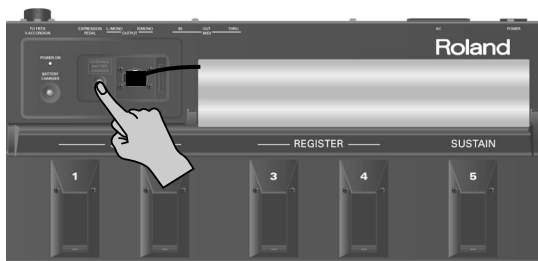

The button now lights red.

- (13) Wait until the **EXTERNAL BATTERY CHARGER** button lights green, then switch off the FBC-7 and disconnect the cable from the socket on the FBC-7 and from the battery.

You can leave the battery where it is until you actually need it.

Note: You can use the FR-7/FR-5 while the battery is being recharged externally.

- (14) Reinstall the cover on the EXTERNAL BATTERY RECHARGER compartment and slide it to the left until it clicks into place.

■ Using the recharged battery

- (15) Switch off the FR-7 (or FR-5).
(16) Prepare a coin.
(17) Remove the cushion located between the Treble keyboard and the bellows.

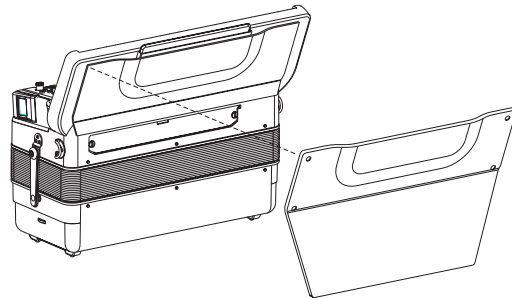

- (18) Use the coin to loosen the two screws of the compartment cover.

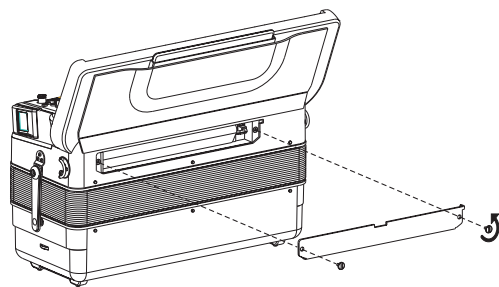

Note: While the compartment cover is open, the FR-7/FR-5 cannot be switched on.

- (19) Remove the depleted battery and disconnect its cable.
(20) Connect the cable to the new battery and insert the charged battery into the FR-7/FR-5's compartment.
(21) Close the FR-7/FR-5's battery compartment and re-install the cushion.

Note: Be sure to tighten the two screws all the way to establish firm contact between the compartment cover and the instrument. Otherwise, you won't be able to use your FR-7/FR-5.

If the battery fails to last 8 hours (or slightly less)

The FR-7's battery (and an optional battery for the FR-5) can be recharged about 300 times before it needs to be replaced with a new one. Note that it is normal for the battery to last increasingly shorter as time goes by. At the end of its life cycle, it may only last one hour, for example. But that is a gradual process.

Note: If the red indicator goes off while the battery is being recharged, this means that there has been a power failure and that the battery has probably only been partially recharged. In that case, you need to recharge it again.

6. Editing sounds

Almost all sound aspects of your FR-7/FR-5 can be changed ("edited") to your liking. On p. 28 we already showed you how to quickly edit the most important parameters of a sound. Those changes are temporary and not followed by a "WRITE" question. If you want to preserve the changes you made using the shortcut functions, you need to use the WRITE function.

Selecting parameters

■ Easy and Full modes

Be aware that the availability of a parameter may depend on the display mode that is currently selected (page 18). If you can't seem to find the parameter you need, switch to "Full" mode.

■ Important note

Before changing your settings, be sure to select the Set the changes should apply to using the SET buttons (or the SET footswitches on the FBC-7). That will help you avoid a lot of confusion at a later stage.

Selecting parameters using the Jump function

The FR-7/FR-5's parameters can be selected like on a mobile phone (by entering their numbers) or using the Menu structure. Let us first look at using the mobile phone approach:

- (1) Switch on the FR-7/FR-5.
See "Switching the power on and off" on p. 15. The display now looks more or less as follows:



- (2) In the descriptions below, locate the parameter you wish to edit and look at its number.
- (3) Press and hold the [EXIT/JUMP] button until the display looks as follows:



- (4) Press a register [1]~[10] to specify the parameter group.

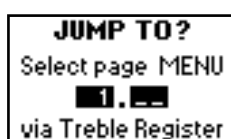

The menu contains the following function groups:

Group	Explanation
1 TUNING*	Parameters related to the overall pitch of your FR-7/FR-5. The Treble, Bass/Free Bass and Orchestra groups contain additional pitch parameters that only apply to those sections.
2 TREBLE EDIT	Parameters for the Treble section (including MIDI parameters).
3 BASS EDIT	Parameters for the Bass section (including MIDI parameters).
4 FREE BASS EDIT	Parameters for the Free Bass section (including MIDI parameters).
5 ORC BASS EDIT	Parameters for the Orchestra Bass section (including MIDI parameters).
6 ORCHESTRA EDIT	Parameters for the Treble Orchestra section (including MIDI parameters).
7 SET COMMON	General Set parameters (effects types, name, Master bar function).
8 SYSTEM*	Parameters that apply to all sections (and hence to the entire FR-7/FR-5).
9 UTILITY	Parameters for checking the battery, copying and archiving settings. This group also contains a function for restoring some or all factory Sets.
10 MIDI*	MIDI channels, MIDI remote control.

Parameter groups with an asterisk (*) are not saved along with the Set parameters. They are global parameters that can be saved to a special memory.

- (5) Press a register [1]~[14] to specify a parameter within the selected group.

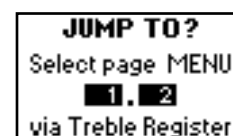

See the table on page 37.

You can only select sections that are active (and thus sound when you play on the Treble or Bass keyboard). If you select a function of a section that is currently off, the display tells you that its parameters cannot be changed. In that case, switch the section on and try again – or select another group.



(The message above means that the Orchestra section is not active and therefore cannot be edited.)

- (6) Proceed with "Setting parameter values" on p. 37.
- (7) Press **EXIT/JUMP** several times to return to the main page.

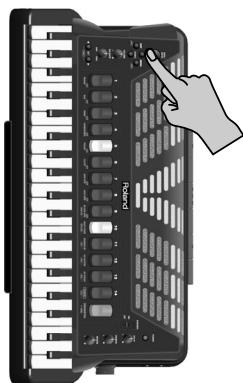

Selecting parameters via the menu

A second way of selecting parameters goes like this:

- (1) Press the **MENU** button.

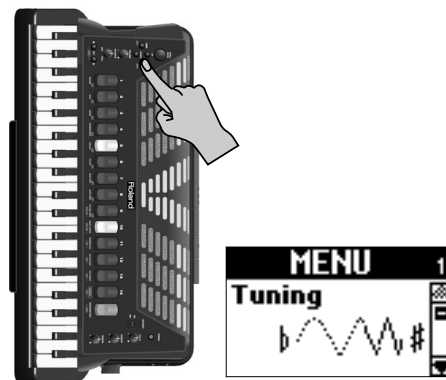

- (2) Use the **DATA/ENTER** knob or the **UP/DOWN** buttons to select one of the function groups. See the previous page for a list with short explanations.
- (3) Press the **DATA/ENTER** knob to enter that group.

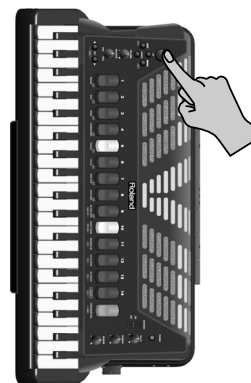

The display now responds with (this depends on the function group you selected):



You can only select sections that are active (and thus sound when you play on the Treble or Bass keyboard). If you select a function of a section that is currently off, the display tells you that its parameters cannot be changed. In that case, switch the section on and try again – or select another group.



(The message above means that the Orchestra section is not active and therefore cannot be edited.)

- (4) Use the **DATA/ENTER** knob or the **UP/DOWN** buttons to select the parameter you wish to edit.
- (5) Proceed with "Setting parameter values".

- (6) Press the **[EXIT/JUMP]** button once to return to the function group ("TUNING" in our example) and again to return to the Main page.

The various groups contain the following parameters (entries in italics are not available in "Easy" mode).

1. TUNING

1.1 Master Tune	p. 38
1.2 Transpose	p. 38
1.3 Scale	p. 38
<i>1.4 Scale Edit</i>	p. 38
1.5 Scale Assign	p. 39

2. TREBLE EDIT

<i>2.1 Reed Type</i>	p. 41
<i>2.2 Register</i>	p. 41
<i>2.3 Reed Volume</i>	p. 42
2.4 Treble Octave	p. 42
<i>2.5 Valve Noise</i>	p. 42
2.6 Musette Detune	p. 42
<i>2.7 Bellows Detune</i>	p. 42
2.8 Reverb Send	p. 42
2.9 Chorus Send	p. 42
2.10 Delay Send	p. 42
2.11 Aftertouch Pitch	p. 42
2.12 Bass Link	p. 42
2.13 Orchestra Link	p. 43
<i>2.14 Treble MIDI TX</i>	p. 44

3. BASS EDIT

<i>3.1 Reed Type</i>	p. 45
<i>3.2 Register</i>	p. 46
<i>3.3 Reed Volume</i>	p. 46
<i>3.4 Button Noise</i>	p. 46
<i>3.5 Reed Growl</i>	p. 46
<i>3.6 Bellows Detune</i>	p. 47
3.7 Reverb Send	p. 47
3.8 Chorus Send	p. 47
3.9 Delay Send	p. 47
<i>3.10 Bass MIDI TX</i>	p. 47
<i>3.11 Chord MIDI TX</i>	p. 47

4. FREE BASS EDIT

<i>4.1 Reed Type</i>	p. 48
<i>4.2 Register</i>	p. 49
<i>4.3 Reed Volume</i>	p. 49
<i>4.4 Button Noise</i>	p. 49
<i>4.5 Reed Growl</i>	p. 49
<i>4.6 Bellows Detune</i>	p. 49
4.7 Reverb Send	p. 49
4.8 Chorus Send	p. 49
4.9 Delay Send	p. 49
<i>4.10 Free Bass MIDI TX</i>	p. 50

5. ORC BASS EDIT

<i>5.1 Lowest Note</i>	p. 51
5.2 Orc Bass Release Time	p. 51
5.3 Orc Bass Volume	p. 52
5.4 Reverb Send	p. 52
5.5 Chorus Send	p. 52
5.6 Delay Send	p. 52
<i>5.7 Orc Bass MIDI TX</i>	p. 52

6. ORCHESTRA EDIT

6.1 Orchestra Octave	p. 53
6.2 Orchestra Volume	p. 53
<i>6.3 Bellows Detune</i>	p. 53
6.4 Reverb Send	p. 54
6.5 Chorus Send	p. 54
6.6 Delay Send	p. 54
6.7 Aftertouch Pitch	p. 54
<i>6.8 Orchestra MIDI TX</i>	p. 54

7. SET COMMON

7.1 Reverb Macro Type	p. 55
<i>7.2 Reverb Parameters</i>	p. 56
7.3 Chorus Macro Type	p. 56
<i>7.4 Chorus Parameters</i>	p. 57
7.5 Delay Macro Type	p. 58
<i>7.6 Delay Parameters</i>	p. 58
7.7 Name	p. 59
7.8 Master Bar Recall	p. 59
7.9 Icon	p. 59

8. SYSTEM

8.1 LCD Contrast	p. 60
8.2 Parameter Access	p. 60
8.3 Bellows Curve	p. 60
8.4 Pedal Controller	p. 60
8.5 Bass & Chord Mode	p. 61
8.6 Free Bass Mode	p. 62
8.7 Stereo Width	p. 62
8.8 Auto Power OFF	p. 63
8.9 Startup	p. 63
8.10 Startup Name	p. 63
8.11 Orch. Bass Touch	p. 63

9. UTILITY

9.1 Battery Status	p. 63
<i>9.2 Copy ALL Effects</i>	p. 64
<i>9.3 Copy Reverb</i>	p. 64
<i>9.4 Copy Chorus</i>	p. 64
<i>9.5 Copy Delay</i>	p. 64
9.6 Copy SET	p. 64
9.7 Bulk Dump ALL	p. 65
9.8 Bulk Dump SET	p. 65
9.9 Restore SET	p. 65

10. MIDI

10.1 RealTime RX-TX	p. 69
10.2 Ext. Seq. Playback	p. 70
10.3 Bellows TX Resolution	p. 71

Setting parameter values

- (1) Select the parameter you wish to edit (see above).
- (2) Press the **[DATA/ENTER]** knob to activate that parameter for editing.
Notice how the display changes: the arrows are replaced by an EDIT message and the parameter value is displayed on a dark background.



If a display page contains two (or three) adjustable parameters, you may have to press **[DATA/ENTER]** again to activate the desired parameter for editing. Here is an example:

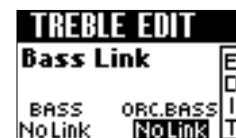

- (3) Use the **[DATA/ENTER]** knob or the **[UP]/[DOWN]** buttons to change the value.
- (4) Press the **[EXIT/JUMP]** button once to return to the function group.

TUNING parameters

MENU 1 **Tuning**  The parameters of the TUNING group apply to the entire FR-7/FR-5 and are not saved to a Set. The FR-7/FR-5 remembers them, however, so that you may have to change them again to return to the factory default. See pages 35 and 37 for how to select and adjust the parameters. Press **UP** and **DOWN** simultaneously to select the value that is indicated as "Default setting".

Saving your changes

Any changes you make can be saved even without using the WRITE function (see p. 78). To avoid losing your changes, it would be a good idea to take advantage of the following automatic routine.

Whenever you press **EXIT/JUMP** after editing a Menu parameter, the FR-7/FR-5 asks you whether you want to save your changes:

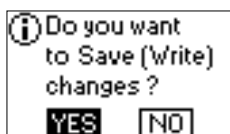

"YES" is selected by default. To save your changes, proceed as described below. (If you don't want to save them, turn the **DATA/ENTER** knob to select "NO", then press the **DATA/ENTER** knob.)

To save your changes:

- Press the **DATA/ENTER** knob. The display now responds with:



Note: The GLOBAL page shows all parameters that are saved to the Global memory (there is only one such memory): the Master Tune and Scale Tune parameters of the TUNING group (the Transpose setting is never saved) as well as the SYSTEM and MIDI groups.

- Press the **MENU/WRITE** button to save your changes. The display briefly shows a confirmation:



Note: If you selected "NO", the edited Global settings will be used until you switch off the FR-7/FR-5 (or change them again).

Note: The SCALE and TUNE settings are saved using a separate WRITE routine (see below).

1.1 Master Tune

(415.3~466.2, Default setting: 440.0) This parameter allows you to change the FR-7/FR-5's overall tuning, which may be necessary when you play with acoustic instruments that cannot be tuned easily or if you use a CD or cassette tape as accompaniment. The factory default, "440.0Hz", represents the reference pitch used by all electronic musical instruments.



1.2 Transpose

(F# -6, G -5, Ab -4, A -3, Bb -2, B -1, C 0, C# 1, D2, Eb 3, E 4, F 5) This parameter allows you to transpose all sections of the FR-7/FR-5. See page 28 for details.



1.3 Scale

This page contains two parameters. The first one allows you to select the tuning system and the second one to specify the fundamental/root of the key you want to play in. This was already discussed on page 29.

Type: Equal (Off), User 1, User 2, User 3, Arabic1, Arabic2, Just Major, Just Minor, Pythagorean, Mean-Tone, Werckmeister, Kirnberger
Key: C, C#, D, Eb, E, F, F#, G, Ab, A, Bb, B



1.4 Scale Edit

Here comes a display page with three selectable and adjustable parameters. You may have noticed that there are three "User" scales. They refer to tuning systems you can program yourself. Obviously, you only need to do this if none of the factory scales corresponds to the system you would like to use (a gamelan tuning, for example).

As this is a rather complex matter, the procedure for programming your tuning is a little different from the adjustment of other parameters:

- After selecting this page, pressing **DATA/ENTER** will do nothing.
- Instead, you need to press the **MENU/WRITE** button to jump to the following page:



- Use the **DATA/ENTER** knob or the **UP/DOWN** buttons to select the User memory that should contain your customized tuning system.
- Press **MENU/WRITE** again to jump to the following page.



(-64~63, Default setting: 0 for all notes) These parameters allow you to stray away from the usual semitone-interval scale (used in western music) by changing the pitch of the notes so as to accommodate other musical cultures.

You will notice that every note can be selected only once. That is because the value you specify applies to all notes of the same name. If you change the tuning of the "C", that value will be added to or subtracted from all Cs (C1, C2, C3, etc.). Most of the time, you will probably select the value "50" or "-50" as they correspond exactly to half a semitone up or down (quarter tone). Other settings may also be interesting, though.

- Press the **DATA/ENTER** knob to select either the note (left field) or the tuning value (right field) and change the entry using the **DATA/ENTER** knob or the **UP/DOWN** buttons.
- Press the **MENU/WRITE** button to memorize your new tuning (or **EXIT/JUMP** to return to the previous settings, in which case your changes are lost). If you press **MENU/WRITE**, the display briefly shows a confirmation:



1.5 Scale Assign

(Treble, Orchestra, Treble&Orchestra, Bass&Chord, ALL, Default setting: Treble&Orchestra) This parameter allows you to specify which section should be affected by the tuning system you select on the "1.3 Scale" page. It is perfectly possible to select a single section (e.g. only the Treble accordion).



TREBLE EDIT parameters



The parameters of the TREBLE EDIT group apply to the Treble section and are saved to the selected Set. They allow you to build your own (virtual) accordion. After setting these parameters, you probably also need to adjust the BASS EDIT or FREE BS EDIT parameters (which are also saved to the Set). See pages 35 and 37 for how to select and adjust the parameters.

Press **UP** and **DOWN** simultaneously to select the value that is indicated as "Default setting".

Introduction

While familiarizing yourself with and using the following parameters, try to think of yourself as an accordion manufacturer. The first parameters in this group indeed rely on the power of Roland's "virtual" technology (called "PBM" or "Physical Behavior Modeling") and are in fact a warehouse with all kinds of accordion components from which you can choose to build your personal accordion or to customize an existing "model".

Though experimenting with the available options may teach you a lot about usable sound combinations, always start out by asking yourself questions like: "Does it sound OK?", "Does it make sense for a Cajun accordion to use a Bandoneon valve noise?", etc.

Another piece of advice is the following: after spending two hours programming a new register, save it, take a break, then listen to it again (or even wait until the next day). Also try it in combination with the other registers/sections and even instruments (if you play in a band).

Important note

All changes you make here apply to the last Treble register you selected. So be sure to press the register (**1**~**14**) whose settings you wish to change before selecting and editing any of the TREBLE EDIT parameters. You can, however, decide to save your settings to a different register (see below) if you realize that you've been editing the wrong one.

Saving your changes

Any changes you make can be saved even without using the WRITE function (see p. 78). To avoid losing your changes, it would be a good idea to take advantage of the following automatic routine.

Whenever you press **EXIT/JUMP** after editing a Menu parameter, the FR-7/FR-5 asks you whether you want to save your changes:

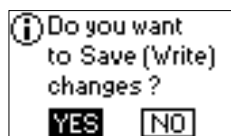

"YES" is selected by default. If you want to save your changes, proceed as described below. (If you don't, turn the **DATA/ENTER** knob to select "NO", then press the **DATA/ENTER** knob.)

Note: You can save your changes later using the WRITE function (see p. 77). But be sure to do so before selecting another Treble register or Set – and before switching the FR-7/FR-5 off.

To save your changes:

- (1) Press the **DATA/ENTER** knob. The display now responds with:



- (2) If necessary, change the name of the Treble register you have just edited (you may want to enter the name of the "Reed Type" you selected).

Entering names

- Select the character position (indicated by a dark square) by pressing **UP** (previous character), **DOWN** (next character) or the **DATA/ENTER** knob (next character).
 - Turn the **DATA/ENTER** knob to select the desired character.
 - Press **UP** and **DOWN** simultaneously to erase the currently selected character (it will become a space). Example: To replace the "s" in "Celeste" with a space ("Cele te"), position the cursor on the "s" and simultaneously press **UP/DOWN**.
 - To insert a space before the currently selected character and push all subsequent characters one position to the right, select the character that should follow the space, then press and hold **UP**. Example: To insert a space before the "s" in "Celeste" (creating the name "Cele ste"), position the cursor on the "s" and hold down **UP** for a while.
Note: If the name already contains 8 characters ("Bandoneo"), the last character is erased (example: "Band one").
 - To delete the character indicated by the cursor and move subsequent characters one position to the left, select it (example: "Celeste") and press and hold **DOWN** ("Celete").
- (3) Press the **MENU/WRITE** button to jump to the following page:

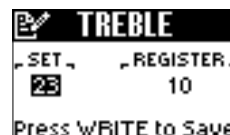

- (4) If necessary, select another Set and another register than the ones you are currently using. Press the **DATA/ENTER** knob to select "SET" or "REGISTER", then turn it to select the number (1~40 for SET, 1~14 for REGISTER).

- (5) Press the **MENU/WRITE** button to save your changes. The display now briefly confirms that your settings have been stored:



Note: Be aware that you can only edit one Treble register at a time. If you select another register before saving the changes for the previously selected register (by selecting "NO"), those changes are erased.

Similarly, do not switch off the FR-7/FR-5 or select another Set before saving settings you want to keep: save them first.

2.1 Reed Type

This parameter allows you to do two things that are impossible with an acoustic accordion: you can (a) transform the selected register into a different instrument and (b) assign different sounds to each footage the register plays.



Note: You can only assign one TYPE to each footage (combinations like "16= Bandoneon, 16= TexMex, 16= Organetto" are impossible).

A register, as you may know, may contain several reeds tuned to different pitches ("feet"), so that you hear the 16', 8' and 4' reeds when you select it, for example. The "Register" parameter below allows you to select the desired footage(s). Here, you specify how each reed (that can be assigned to a register) should sound. This allows for complex combinations like the following:

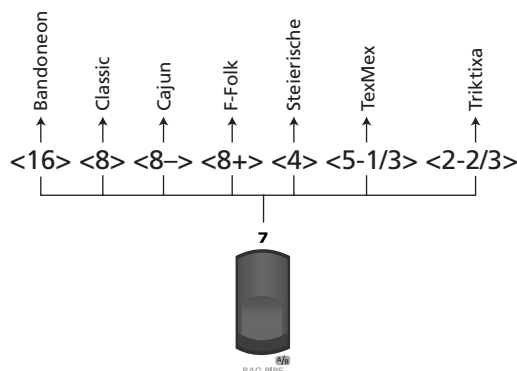

We'll let you decide whether such a combination really makes sense, but it is possible... For each of the 14 Treble registers, that is.

- If necessary, press the **DATA/ENTER** knob to select the "FOOT" parameter, then rotate the **DATA/ENTER** knob to select the reed you wish to assign another sound to.
The options are: ALL, 16, 8, 8-, 8+, 4, 5-1/3, 2-2/3
- Press the **DATA/ENTER** knob to select the "TYPE" parameter, then rotate the **DATA/ENTER** knob to select a type ("instrument").

The TYPE options are: Bandoneon, I-Folk, I-Folk2, Classic, Cajun, Jazz, F-Folk, D-Folk, Organetto, F-Folk2, Classic2, Studio, Tradition, Steierische, OldItaly, TexMex, Trikitixa.

To save time while changing the TYPE for one or several reeds, you could proceed as follows: suppose all reeds are currently set to the "wrong" TYPE and you want to use 16', 8' and 4' as "Bandoneon". In that case, set FOOT to "ALL" and TYPE to "Bandoneon". Next, use STATUS on the "2.2 Register" page to switch off the reeds you do not need.

Note: Whenever you select "ALL" and set a different reed type, the "2.5 Valve Noise" setting is automatically adapted to the reed type you select here. You may have to change it afterwards if you wish to use a different noise type.

2.2 Register

The parameters on this page are used in combination with the settings above. Here, you decide which feet should be audible and how they should be played.



It is therefore on this page that you specify whether the sounds you selected above will indeed be used.

Here comes another illustration:

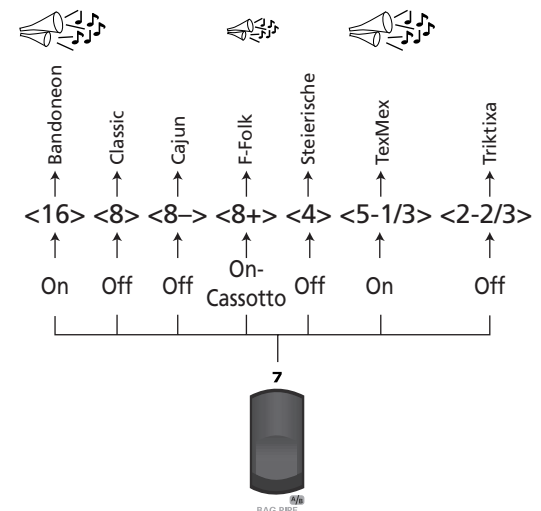

In our example, only 16', 8'+ and 5-1/3' are used. 8'+ is slightly softer than then other two reeds, because the Cassotto function is on. "Cassotto" is similar to the "Sordina" function discussed on page 21, but it only muffles the reed/footage in question (making the sound darker). The Sordina switch, on the other hand, applies to all accordion sounds of the Treble section.

- If necessary, press the **DATA/ENTER** knob to select the "FOOT" parameter, then rotate the **DATA/ENTER** knob to select the reed you wish to assign another sound to.
The options are: 16, 8, 8-, 8+, 4, 5-1/3, 2-2/3
- Press the **DATA/ENTER** knob to select the "STATUS" parameter, then rotate the **DATA/ENTER** knob to specify whether the selected reed should sound and whether it should be muffled.
The STATUS options are: Off (no sound), On (sounds), On-Cassotto (muffled sound).

2.3 Reed Volume

(Off, -30~"Std"~30, Default setting: Std) Here comes the last parameter that can be set for each reed/footage individually. It allows you to create the desired "mix" (volume balance) for the active reeds (see the "2.2 Register" page).

This is a relative parameter, which means that its value is added to or subtracted from the standard value ("Std"). As a rule, it would be wise to decide which reed is most important and set its Volume parameter to "Std". Then reduce or increase the volume of the "ancillary" reeds to create the desired balance.

Note: The overall volume of the Treble section (all registers) can be changed using the **BALANCE** knob.



2.4 Treble Octave

(-1, 0, 1, Default setting: 0) This parameter allows you to transpose the selected register one octave up ("1") or down ("-1"). This can be used for two purposes: to quickly correct the pitch that results from the active reeds (see above) or to avoid overlaps of the selected register when using a Treble Orchestra sound. (The Orchestra section also provides an Octave parameter.)



2.5 Valve Noise

Here comes a more elaborate version of the Noise parameter discussed on page 30, because it allows you not only to set the level of the "typical" valve noises, but also to specify what kind of instrument should generate the noise. Though you are free to experiment with any noise type you like, using the noise related to the selected instrument (see "2.1 Reed Type") is usually more realistic.



There is only one TYPE for the entire register (i.e. all 7 reeds). The options are: Bandoneon, I-Folk, I-Folk2, Classic, Cajun, Jazz, F-Folk, D-Folk, Organetto, F-Folk2, Classic2, Studio, Tradition, Steierische, OldItaly, TexMex, Trikitixa.

Use the LEVEL parameter to specify how prominent the noise should be (-30~"Std"~30, Default setting: Std).

Note: Whenever you select "ALL" for "2.1 Reed Type" and set a different reed type, this noise setting is automatically adapted to the reed type. It would therefore be a good idea to first select the reed type and only then change the noise type.

2.6 Musette Detune

This parameter allows you to choose the system used for detuning the 8' reeds. See page 28 for details. The options are: Off, Dry, Classic, F-Folk, American_L, American_H, North_Eur, German_L, D-Folk_L, Italian_L, German_H, Alpine, Italian_H, D-Folk_H, French, Scottish.



2.7 Bellows Detune

(Off, Low, Standard, High, Default setting: Standard) This parameter further adds to the realism of the sounds emulated by your FR-7/FR-5. Here, you can specify how strongly the pitch of the simulated Treble reed(s) changes when you open or close the bellows faster than usual.



If the "Standard" setting seems too mild, try "High". If it is too strong, use "Low". If you don't want any detuning effect, select "Off". The most convincing setting usually depends on the selected instrument(s) (see "2.1 Reed Type").

2.8 Reverb Send, 2.9 Chorus Send, 2.10 Delay Send

(0~127 for all three) Use these parameters to set the Reverb, Chorus or Delay send level (how much effect should be applied to the Treble section). The higher the value you set, the more the Treble section is processed by the effect in question.



It works much the same way as a cathedral: the louder you sing, the more reverb (chorus or delay) you hear. In the case of the cathedral, singing louder means that you increase the effect send level, i.e. the level of the signal (your voice) that will be processed by the acoustic environment.

The other sections (Bass, Free Bass, etc.) have the same parameters, so that you can create a sound image with various "levels" (foreground, background).

The effects themselves can be edited on separate pages (see p. 56).

2.11 Aftertouch Pitch

(Off, 1/4 Down, 1/2 Down, 1/4 Up, 1/2 Up, Default setting: Off) As stated earlier, the FR-7/FR-5's Treble keyboard also generates aftertouch messages.



"Aftertouch" refers to the fact that you press a key even further down after playing a note. This effect allows you to bend the pitch down (temporarily lower the note) by a quarter ("1/4 Down") or a semi-tone ("1/2 Down"). Select "1/4 Up" or "1/2 Up" to bend the notes up a quarter or a semi-tone. Select "Off" to switch off the Treble section's aftertouch recognition.

Note: This aftertouch effect applies to all notes that are sounding simultaneously. If you play a chord and then only press down one key of the chord's constituent notes, all notes are bent by the same amount. (MIDI buffs call this "channel aftertouch".)

2.12 Bass Link

Here are two parameters that allow you specify which Bass and/or Orchestra Bass register/sound are selected whenever you press the Treble register you

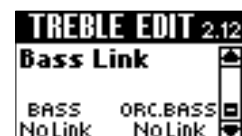

are currently editing. That way, you only need to press one register instead of at least two (one Treble, one Bass). There is yet another parameter that allows you to associate a Treble Orchestra sound with the currently selected accordion register (see below).

The options for these parameters are:

- BASS: No Link, Bass 1~7, Free 1~7
- ORC.BASS: No Link, Acoustic, Bowed, Fingered, Fretless, Picked, Tuba, Tuba Mix

If you define a "Free" register, the Bass section automatically switches to Free Bass mode when you press the Treble register while the Bass Link function is active. (If you define a "Bass" register, the Bass section switches from Free Bass to Bass mode, if necessary.)

If you also define an ORC.BASS sound (other than "No Link"), the Bass section automatically activates the Orchestra Bass part when you press the Treble register while the Bass Link function is active.

Select "No Link" if there should be no connection between the currently selected Treble register and the Bass or Orchestra Bass section.

Note that this automatic link is not activated when you define it on this page – it is merely enabled and "pre-set". To activate the Bass Link function, press and hold down the [ORCHESTRA] register and press [9]:



Note: Be aware that the Link function can be dangerous if you edited the currently selected Bass, Free Bass or Orchestra Bass register without saving it. Selecting another register automatically (via the Link function) indeed means that the changes for the previously selected register are lost. Consider using the WRITE function (page 77) before activating the link – even if it's only to check whether the settings have indeed been saved.

Note: Simply activating the link does nothing at all (i.e. the Bass/Free Bass/Orchestra Bass register does not change right away). You need to select another Treble register whose Bass Link function is on for the link to work.

Repeat this procedure to defeat the Bass Link function if you no longer need it.

On the Main page, links are indicated as follows:



Note: You can specify that this function should be activated automatically each time you switch the FR-7/FR-5 on. See "8.9 Startup" on p. 63.

2.13 Orchestra Link

This function allows you to associate an orchestral sound with the Treble register you are currently editing and to specify which mode should be used. See also "Selecting the Orchestra mode" on p. 25 for an explanation of the available modes.



The options for these parameters are:

- REGISTER: No Link, 1A Trombone, 1B Trumpet, 2A TenorSax, 2B AltoSax, 3A Clarinet, 3B Oboe, 4A Harmonica, 4B MuteHarm, 5A Violin, 5B Pizzicato, 6A Flute, 6B PanFlute, 7A HighLand, 7B Zampogna, 8A PercOrgan, 8B JazzOrgan, 9A RotOrgan, 9B TremOrg, 10 ScatVoice, 11 Mandolin, 12 AcGuitar, 13 AcPiano

- MODE: ----, Solo, Dual, High, Low
Select "No Link" if there should be no connection between the currently selected Treble register and the Orchestra Treble section.

"--" means that the currently selected mode does not change. So if LOW mode is selected when you press this register, the Orchestra sound you select here can be played in LOW mode.

Note that this automatic link is not activated when you define it on this page – it is merely enabled and "pre-set". To activate the Orchestra Link function, you need to press and hold down the [ORCHESTRA] register and press [10]:



Note: Be aware that the Link function can be dangerous if you edited the currently selected Orchestra sound without saving it. Selecting another Orchestra sound automatically (via the Link function) indeed means that the changes for the previously selected sound are lost. Consider using the WRITE function (page 77) before activating the link – even if it's only to check whether the settings have indeed been saved.

Note: Simply activating the link does nothing at all (i.e. the Orchestra sound does not change right away). You need to select another Treble register whose Orchestra Link function is on for the link to work.

Repeat this procedure to defeat the Orchestra Link function if you no longer need it (or assign "CANCEL" to another Treble register and press it).

On the main page, links are indicated as follows:



Note: You can specify that this function should be activated automatically each time you switch the FR-7/FR-5 on. See "8.9 Startup" on p. 63.

2.14 Treble MIDI TX

This page contains a series of MIDI parameters for the selected register you need to set one by one. See page 72 for details about the MIDI parameters.

These parameters are saved along with all other Set parameters, which allows you to use different MIDI settings for each Set – and even each register within a Set.



BASS EDIT parameters



The parameters of the BASS EDIT group apply to the Bass section (bass and chord notes) and are saved to the selected Set. They allow you to build your own (virtual) accordion. After setting these parameters, you probably also need to adjust the TREBLE EDIT or FREE BS EDIT parameters (which are also saved to the Set). See pages 35 and 37 for how to select and adjust the parameters.

Press **UP** and **DOWN** simultaneously to select the value that is indicated as "Default setting". See also "Introduction" on p. 40 for some general hints.

Important note

All changes you make here apply to the last Bass register you selected. So be sure to press the register whose settings you wish to change before selecting and editing any of the BASS EDIT parameters. You can, however, decide to save your settings to a different register (see below) if you realize that you've been editing the wrong one.

Saving your changes

Any changes you make can be saved even without using the WRITE function (see p. 78). To avoid losing your changes, it would be a good idea to take advantage of the following automatic routine.

Whenever you press **EXIT/JUMP** after editing a Menu parameter, the FR-7/FR-5 asks you whether you want to save your changes:

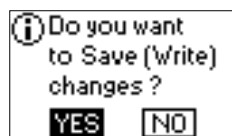

"YES" is selected by default. If you want to save your changes, proceed as described below. (If you don't, turn the **DATA/ENTER** knob to select "NO", then press the **DATA/ENTER** knob.)

Note: You can save your changes later using the WRITE function (see p. 77). But be sure to do so before selecting another Bass register or Set – and before switching the FR-7/FR-5 off.

To save your changes:

- (1) Press the **DATA/ENTER** knob. The display now responds with:



- (2) If necessary, change the name of the Bass register you have just edited (you may want to enter the name of the "Reed Type" you selected). See "Entering names" on p. 40.
- (3) Press the **MENU/WRITE** button to jump to the following page:

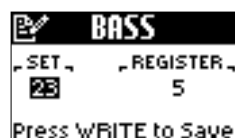

- (4) If necessary, select another Set and another register than the ones you are currently using. Press the **DATA/ENTER** knob to select "SET" or "REGISTER", then turn it to select the number (1~40 for SET, 1~7 for REGISTER).
- (5) Press the **MENU/WRITE** button to save your changes. The display now briefly confirms that your settings have been stored:



Note: You can only edit one Bass register at a time. If you select another register before saving the changes for the previously selected register (by selecting "NO"), those changes are erased. Do not switch to Free Bass or Orchestra Bass mode before deciding whether or not you want to save your changes.

Similarly, do not switch off the FR-7/FR-5 or select another Set before saving settings you want to keep: save them first.

3.1 Reed Type

This parameter allows you to transform the selected register into a different instrument and assign different sounds to each reed the register plays. See "2.1 Reed Type" on p. 41 for a discussion of the possibilities and the aspects you need to pay attention to. Bear in mind, however, that the parameter on this page applies to the selected Bass register.



- If necessary, press the **DATA/ENTER** knob to select the "FOOT" parameter, then rotate the **DATA/ENTER** knob to select the reed you wish to assign another sound to.

The options are: ALL, 16, 8, 8-4, 4, 2

- Press the **DATA/ENTER** knob to select the "TYPE" parameter, then rotate the **DATA/ENTER** knob to select a type ("instrument").

The TYPE options are: Bandoneon, I-Folk, I-Folk2, Classic, Cajun, Jazz, F-Folk, D-Folk, Organetto, F-Folk2, Classic2, Studio, Tradition, Steierische, Trikitixa

To save time while changing the TYPE of one or several reeds, you could proceed as follows: suppose all reeds are currently set to the wrong TYPE and you want to use 16', 8' and 4' as "Bandoneon". In that case, set FOOT to "ALL" and TYPE to "Bandoneon". Next, use STATUS on the "3.2 Register" page to switch off the reeds you do not need.

3.2 Register

The parameters on this page are used in combination with the parameters above. Here, you decide which reeds should be audible and how they should be played. It is therefore on this page that you specify whether the sounds you selected above will be used.



- If necessary, press the **[DATA/ENTER]** knob to select the "FOOT" parameter, then rotate the **[DATA/ENTER]** knob to select the desired reed. The options are: 16, 8, 8-4, 4, 2
- Press the **[DATA/ENTER]** knob to select the "STATUS" parameter, then rotate the **[DATA/ENTER]** knob to specify whether the selected reed should sound and whether you can or cannot use it to play chords. The STATUS options are: Off, Bass, Chord, Bass&Chord. The available options depend on the selected footage, however:

	16	8	8-4	4	2
Off	yes	yes	yes	yes	yes
Chord	no	no	yes	yes	yes
Bass	yes	yes	no	no	no
Bass&Chord	no	no	yes	yes	yes

Note: This setting partially applies to all reeds. You cannot assign "Bass&Chord" to "8-4", for instance, and "Chord" to "2". All reeds (16 & 8 for the bass, 8-4, 4 & 2 for the chords) must use the same assignment. If you select "Bass&Chord" for "4" and then set "2" to "Chord", "4" automatically switches to "Chord" (the last selection you make is adopted by all reeds of the same "yes" group). You can, however, select "Off" for each reed individually.

Note: Whenever you select "ALL" and set a different reed type, the "3.4 Button Noise" and "3.5 Reed Growl" settings are automatically adapted to the reed type you select here. You may have to change those settings afterwards if you wish to use different noise type.

3.3 Reed Volume

(Off, -30~"Std"~30, Default setting: Std) This is the last parameter that can be set for each reed individually. It allows you to create the desired "mix" (volume balance) for the active reeds (see the "3.2 Register" page).



This is a relative parameter, which means that its value is added to or subtracted from the standard value ("Std"). As a rule, it would be wise to decide which reed is most important and set its Volume parameter to "Std". Then reduce or increase the volume of the "ancillary" reeds to create the desired balance.

Note: The overall volume of the Bass section (all registers) can be changed using the **[BALANCE]** knob.

3.4 Button Noise

The bass section of almost all accordion instruments can be played via buttons. Such buttons produce a typical noise when pressed. On this page, you can specify the instrument whose button noises should be used when you select this register while playing. (Note that other Bass registers can be assigned different noises.)



There is only one TYPE for the entire register (i.e. all 5 reeds). The options are: Bandoneon, I-Folk, I-Folk2, Classic, Cajun, Jazz, F-Folk, D-Folk, Organetto, F-Folk2, Classic2, Studio, Tradition, Steierische, Trikitixa.

Use the LEVEL parameter to specify how prominent the noise should be (-30~"Std"~30, Default setting: Std).

Note: Whenever you select "ALL" for "3.1 Reed Type" and set a different reed type, this noise setting is automatically adapted to the reed type. It would therefore be a good idea to first select the reed type and only then change the noise type.

3.5 Reed Growl

This parameter allows you to simulate the typical noise a bass reed makes just before it stops vibrating altogether (a kind of "musical flatulence" if you will).



Each instrument of the accordion family produces its own typical growl. The growl that matches the sound selected with "3.1 Reed Type" probably yields the most realistic effect – but feel free to select another one if you like it better.

- If necessary, press the **[DATA/ENTER]** knob to select the "TYPE" parameter, then rotate the **[DATA/ENTER]** knob to select one of the available instrument types: Bandoneon, I-Folk, I-Folk2, Classic, Cajun, Jazz, F-Folk, D-Folk, Organetto, F-Folk2, Classic2, Studio, Tradition, Steierische, Trikitixa
- Press the **[DATA/ENTER]** knob to select the "LEVEL" parameter, then rotate the **[DATA/ENTER]** knob to set the volume of the Reed Growl sound (-30~"Std"~30). **Note:** Whenever you select "ALL" for "3.1 Reed Type" and set a different reed type, this growl setting is automatically adapted to the reed type. It would therefore be a good idea to first select the reed type and only then change the growl type.

3.6 Bellows Detune

(Off, Low, Standard, High, Default setting: Standard) This parameter further adds to the realism of the sounds emulated by your FR-7/FR-5. Here, you can specify how strongly the pitch of the simulated Bass reed(s) changes when you open or close the bellows faster than usual.

If the "Standard" setting seems too mild, try "High". If it is too strong, use "Low". If you do not want any detuning effect, select "Off". The most convincing setting usually depends on the selected instrument(s) (see "3.1 Reed Type").



3.7 Reverb Send, 3.8 Chorus Send, 3.9 Delay Send

(0~127 for all three) Use these parameters to set the Reverb, Chorus or Delay send level (how much effect should be applied to the Bass section).

The higher the value you set, the more the Bass section will be processed by the effect in question.

The other sections (Treble, Free Bass, etc.) have the same parameters, so that you can create a sound image with various "levels" (foreground, background).

The effects themselves can be edited on separate pages (see p. 56).



3.10 Bass MIDI TX, 3.11 Chord MIDI TX

These pages contain a series of MIDI parameters for the selected register you need to set one by one. One page allows you to specify which MIDI messages the bass notes (i.e. the two or three button rows closest to the bellows) should transmit, the other does the same for the chords (the remaining buttons in the Bass section). See page 72 for details about the MIDI parameters. These parameters are saved along with all other Set parameters, which allows you to use different MIDI settings for each Set – and even each register within a Set.



FREE BASS EDIT parameters



The parameters of the FREE BS EDIT group apply to the Bass section when it is used in Free Bass mode (see p. 23) and are saved to the selected Set. They allow you to build your own (virtual) accordion. After settings these parameters, you probably also need to adjust the TREBLE EDIT parameters (which are also saved to a Set). See pages 35 and 37 for how to select and adjust the parameters.

Press **[UP]** and **[DOWN]** simultaneously to select the value that is indicated as "Default setting". See also "Introduction" on p. 40 for some general hints.

Important notes

- All changes you make here apply to the last Free Bass register you selected. So be sure to press the register whose settings you wish to change before selecting and editing any of the FREE BS EDIT parameters. You can, however, decide to save your settings to a different register (see below) if you realize that you've been editing the wrong one.
- See page 62 for how to select the note system for Free Bass mode. That setting is shared by all Sets.

Saving your changes

Any changes you make can be saved even without using the WRITE function (see p. 77). To avoid losing your changes, it would be a good idea to take advantage of the following automatic routine.

Whenever you press **[EXIT/JUMP]** after editing a Menu parameter, the FR-7/FR-5 asks you whether you want to save your changes:

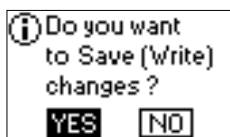

"YES" is selected by default. If you want to save your changes, proceed as described below. (If you don't, turn the **[DATA/ENTER]** knob to select "NO", then press the **[DATA/ENTER]** knob.)

Note: You can save your changes later using the WRITE function (see p. 77). But be sure to do so before selecting another Free Bass register or Set – and before switching the FR-7/FR-5 off.

To save your changes:

- (1) Press the **[DATA/ENTER]** knob. The display now responds with:



- (2) If necessary, change the name of the Free Bass register you have just edited (you may want to enter the name of the "Reed Type" you selected). See "Entering names" on p. 40.

- (3) Press the **[MENU/WRITE]** button to jump to the following page:



- (4) If necessary, select another Set and another register than the ones you are currently using. Press the **[DATA/ENTER]** knob to select "SET" or "REGISTER", then turn it to select the number (1~40 for SET, 1~7 for REGISTER).

- (5) Press the **[MENU/WRITE]** button to save your changes. The display now briefly confirms that your settings have been stored:



Note: You can only edit one Free Bass register at a time. If you select another register before saving the changes for the previously selected register (by selecting "NO"), those changes are erased. Do not switch to Bass or Orchestra Bass mode before deciding whether or not you want to save your changes. Similarly, do not switch off the FR-7/FR-5 or select another Set before saving settings you want to keep: save them first.

4.1 Reed Type

This parameter allows you to transform the selected register into a different instrument and assign different sounds to each footage the register plays.



Note: You will notice that there are fewer options here than for the Bass section. That's because you cannot play chords in Free Bass mode.

- If necessary, press the **[DATA/ENTER]** knob to select the "FOOT" parameter, then rotate the **[DATA/ENTER]** knob to select the reed you wish to assign another sound to. The options are: ALL, 16, 8
- Press the **[DATA/ENTER]** knob to select the "TYPE" parameter, then rotate the **[DATA/ENTER]** knob to select a type ("instrument").

The TYPE options are: Bandoneon, I-Folk, I-Folk2, Classic, Cajun, Jazz, F-Folk, D-Folk, Organetto, F-Folk2, Classic2, Studio, Tradition, Steierische, Trikitixa

Note: Whenever you select "ALL" and set a different reed type, the "4.4 Button Noise" and "4.5 Reed Growl" settings are automatically adapted to the reed type you select here. You may have to change those settings afterwards if you wish to use different noise type.

4.2 Register

The parameters on this page are used in combination with the parameters above. Here, you decide which reeds should be audible and how they should be played. It is therefore on this page that you specify whether the sounds you selected above will be used.



- If necessary, press the **[DATA/ENTER]** knob to select the "FOOT" parameter, then rotate the **[DATA/ENTER]** knob to select the reed you wish to assign another sound to. The options are: ALL, 16, 8
- Press the **[DATA/ENTER]** knob to select the "STATUS" parameter, then rotate the **[DATA/ENTER]** knob to specify whether the selected reed should sound and which buttons can be used to play it. The STATUS options are: Off (no sound), Low (the lower half), High (upper half), Whole (all buttons). These options allow you to program what keyboard players would call a "split". You can create several nifty combinations, like "High" for 8' and "Low" for 16' (or vice versa) or "Whole" for 16' (all buttons) and "High" for 8' (only the upper three rows).

Note: Assigning the same partial STATUS ("High" or "Low") to both reeds is a bit odd, because it leaves you with only half the number of active bass buttons. But it is possible...

4.3 Reed Volume

(Off, -30~"Std"~30, Default setting: Std) This is the last parameter that can be set for each reed individually. It allows you to create the desired "mix" (volume balance) for the active reeds.



This is a relative parameter, which means that its value is added to or subtracted from the standard value ("Std"). As a rule, it would be wise to decide which reed is most important and set its Volume parameter to "Std". Then reduce or increase the volume of the "ancillary" reed to create the desired balance.

Note: The overall volume of the Free Bass section (all registers) can be changed using the **[BALANCE]** knob.

4.4 Button Noise

The bass section of almost all accordion instruments can be played via buttons. Such buttons produce a typical noise when pressed. On this page, you can select the instrument whose button noises should be used when you select this register. (Note that other Free Bass registers can be assigned different noises.)



Notice that there is only one TYPE for the entire register. The options are: Bandoneon, I-Folk, I-Folk2, Classic, Cajun, Jazz, F-Folk, D-Folk, Organetto, F-Folk2, Classic2, Studio, Tradition, Steierische, Trikitixa

Use the LEVEL parameter to specify how prominent the noise should be (-30~"Std"~30, Default setting: Std).

Note: Whenever you select "ALL" for "4.1 Reed Type" and set a different reed type, this noise setting is automatically adapted to the reed type. It would therefore be a good idea to first select the reed type and only then change the noise type.

4.5 Reed Growl

This parameter allows you to simulate the typical noise a bass reed makes just before it stops vibrating altogether. Each instrument of the accordion family produces its own typical growl. The growl that matches the sound selected with "4.1 Reed Type" probably yields the most realistic effect – but feel free to select another one if you like it better.



- If necessary, press the **[DATA/ENTER]** knob to select the "TYPE" parameter, then rotate the **[DATA/ENTER]** knob to select one of the available instrument types: Bandoneon, I-Folk, I-Folk2, Classic, Cajun, Jazz, F-Folk, D-Folk, Organetto, F-Folk2, Classic2, Studio, Tradition, Steierische, Trikitixa
- Press the **[DATA/ENTER]** knob to select the "LEVEL" parameter, then rotate the **[DATA/ENTER]** knob to set the volume of the Reed Growl parameter (-30~"Std"~30).

Note: Whenever you select "ALL" for "4.1 Reed Type" and set a different reed type, this growl setting is automatically adapted to the reed type. It would therefore be a good idea to first select the reed type and only then change the growl type.

4.6 Bellows Detune

(Off, Low, Standard, High, Default setting: Standard) This parameter further adds to the realism of the sounds emulated by your FR-7/FR-5. Here, you can specify how strongly the pitch of the simulated Free Bass reed(s) changes when you open or close the bellows faster than usual.



If the "Standard" setting seems too mild, try "High". If it is too strong, use "Low". If you do not want any detuning effect, select "Off". The most convincing setting usually depends on the selected instrument(s) (see "4.1 Reed Type").

4.7 Reverb Send, 4.8 Chorus Send, 4.9 Delay Send

(0~127 for all three) Use these parameters to set the Reverb, Chorus or Delay send level (how much effect should be applied to the Free Bass section). The higher the value you set, the more the Free Bass section will be processed by the effect in question. The other sections (Treble, Bass, etc.) have the same parameters, so that you can create a sound image with various "levels" (foreground, background).



The effects themselves can be edited on separate pages (see p. 56).

4.10 Free Bass MIDI TX

This page contains a series of MIDI parameters for the selected register you need to set one by one.



See page 72 for details about the MIDI parameters. These parameters are saved along with all other Set parameters, which allows you to use different MIDI settings for each Set – and even each register within a Set.

ORC.BASS EDIT parameters



The parameters of the ORC.BASS EDIT group allow you to edit the Orchestra Bass section. See page 27 for details about the Orchestra Bass section. See pages 35 and 37 for how to select and adjust the parameters.

Press **[UP]** and **[DOWN]** simultaneously to select the value that is indicated as "Default setting".

Important note

The selection of Orchestra Bass sounds can be automated on the "2.12 Bass Link" page (page 42) – for each Treble register.

Saving your changes

Any changes you make can be saved even without using the WRITE function (see p. 77). To avoid losing your changes, it would be a good idea to take advantage of the following automatic routine.

Whenever you press **[EXIT/JUMP]** after editing a Menu parameter, the FR-7/FR-5 asks you whether you want to save your changes:

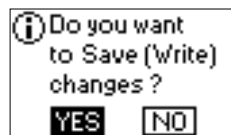

"YES" is selected by default. If you want to save your changes, proceed as described below. (If you don't, turn the **[DATA/ENTER]** knob to select "NO", then press the **[DATA/ENTER]** knob.)

Note: You can save your changes later using the WRITE function (see p. 77). But be sure to do so before selecting another Set – and before switching the FR-7/FR-5 off.

To save your changes:

- (1) Press the **[DATA/ENTER]** knob. The display now responds with:



- (2) If necessary, select another Set than the one you are currently using.
- (3) Press the **[WRITE]** button to save your changes. The display now briefly confirms that your settings have been stored:



Note: Do not switch off the FR-7/FR-5 or select another Set before saving settings you want to keep: save them first.

5.1 Lowest Note

This parameter allows you to specify the lowest note the selected sound can play. If you have ever worked with a Roland arranger module, you may be familiar with the term "Wrap". That is precisely what this parameter does.



The Orchestra Bass sounds (like the Orchestra sounds of the Treble section) are PCM waveforms (samples) of acoustic instruments. Each acoustic instrument has a set range: it cannot sound notes below or above that range. A normally tuned 4-string bass guitar allows you to play a low E, but not the D below it, for instance:



Samples (PCM waveforms), on the other hand, can lower the pitch of a recorded sound almost indefinitely. But that doesn't sound very natural. The "Lowest Note" parameter allows you to specify the lowest pitch the sample can use. If you nevertheless play a lower note on the button keyboard, it will be sounded one octave above the corresponding pitch – and sound natural. Here is an example:

If this is what you play on the button keyboard...



...after choosing... Lowest Note = E (28)

...these notes are transposed 1 octave up.



The Orchestra Bass sound therefore sometimes changes octaves. For some songs, the default setting (E 28) may yield odd results, especially if you need to play walking bass lines, etc. In that case, you can change the "Lowest Note" setting to achieve a satisfactory result.

The options are: E 28, F 29, F# 30, G 31, A♭ 32, A 33, B♭ 34, B 35, C 36; Default setting: E 28. (The figures refer to the MIDI note numbers – each MIDI note has its own "address".)

5.2 Orc Bass Release Time

(0~63, Default setting: 0) This parameter allows you change the way in which a note stops when you release the corresponding button. Though all Orchestra Bass sounds have been prepared in such a way as to decay naturally when a button is released, there may be situations where the end of the notes is too sudden for comfort.

In that case, you can increase this value. "0" means that you agree with the preprogrammed Release value. All other values cause the notes to linger increasingly longer.



5.3 Orc Bass Volume

(Off, -30~"Std"~30, Default setting: Std) This parameter allows you to set the level of the Orchestra Bass part. See also page 27.



5.4 Reverb Send, 5.5 Chorus Send, 5.6 Delay Send

(0~127 for all three) Use these parameters to set the Reverb, Chorus or Delay send level (how much effect should be applied to the Orchestra Bass section). The higher the value you set, the more the Orchestra Bass section will be processed by the effect in question.

The other sections (Treble, Bass, etc.) have the same parameters, so that you can create a sound image with various "levels" (foreground, background). Do note, however, that reverb or delay effects are hardly ever used for bass sounds.

The effects themselves can be edited on separate pages (see p. 56).



5.7 Orc Bass MIDI TX

This page contains a series of MIDI parameters for the Orchestra Bass part you need to set one by one.

See page 72 for details about the MIDI parameters. These parameters are saved along with all other Set parameters, which allows you to use different MIDI settings for each Set.



ORCH. EDIT parameters



The parameters of the ORCH. EDIT group apply to the Treble Orchestra section. See page 24 for details about the Orchestra section. You may remember that it contains 22 sounds (because some registers provide access to an "A" and a "B" sound). See pages 35 and 37 for how to select and adjust the parameters.

Press **UP** and **DOWN** simultaneously to select the value that is indicated as "Default setting".

Important note

The selection of Orchestra sounds and modes can be automated using the "2.13 Orchestra Link" parameter (page 43) – for each Treble register.

Saving your changes

Any changes you make can be saved even without using the WRITE function (see p. 77). To avoid losing your changes, it would be a good idea to take advantage of the following automatic routine.

Whenever you press **EXIT/JUMP** after editing a Menu parameter, the FR-7/FR-5 asks you whether you want to save your changes:

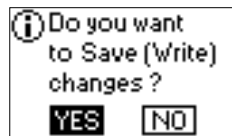

"YES" is selected by default. If you want to save your changes, proceed as described below. (If you don't, turn the **DATA/ENTER** knob to select "NO", then press the **DATA/ENTER** knob.)

Note: You can save your changes later using the WRITE function (see p. 77). But be sure to do so before selecting another Set – and before switching the FR-7/FR-5 off.

To save your changes:

- (1) Press the **DATA/ENTER** knob. The display now responds with:

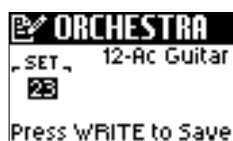

- (2) If necessary, select another Set than the one you are currently using.
- (3) Press the **MENU/WRITE** button to save your changes. The display now briefly confirms that your settings have been stored:



Note: Do not switch off the FR-7/FR-5 or select another Set before saving settings you want to keep: save them first.

6.1 Orchestra Octave

(-1~0~1, Default setting: 0) This parameter allows you to transpose the Orchestra section (i.e. the currently selected orchestral sound) up or down.



This can be interesting when you are using the Orchestra part in Dual mode (page 25) and want it to sound above or below the selected Treble accordion register.

6.2 Orchestra Volume

(Off, -30~"Std"~30, Default setting: Std) This parameter allows you to create the desired "mix" (volume balance) between the Treble accordion and the Orchestra section.



This is a relative parameter, which means that its value is added to or subtracted from the standard value ("Std").

6.3 Bellows Detune

(Off, Low, Standard, High, Default setting: Standard) This parameter allows you to specify how strongly the Orchestra sound's pitch should be influenced by opening and closing the bellows faster than usual. This may further add to the realism of sounds like 1A~4B, 6A, 6B and 10~12.



If the "Standard" setting seems too mild, try "High". If it is too strong, use "Low". If you do not want any detuning effect, select "Off". The most convincing setting usually depends on the selected sound.

6.4 Reverb Send, 6.5 Chorus Send, 6.6 Delay Send

(0~127 for all three) Use these parameters to set the Reverb, Chorus or Delay send level (how much effect should be applied to the Orchestra section). The higher the value you set, the more the Orchestra section will be processed by the effect in question.

It works much the same way as a cathedral: the louder you sing, the more reverb (chorus or delay) you hear. In the case of the cathedral, singing louder means that you increase the effect send level, i.e. the level of the signal (your voice) that will be processed by the acoustic environment.

The other sections (Bass, Free Bass, etc.) have the same parameters, so that you can create a sound image with various "levels" (foreground, background).

The effects themselves can be edited on separate pages (see p. 56).



6.7 Aftertouch Pitch

(Off, 1/4 Down, 1/2 Down, 1/4 Up, 1/2 Up, Default setting: Off)

The FR-7/FR-5's Treble keyboard generates aftertouch messages.

"Aftertouch" refers to the fact that you press a key even further down after playing a note. This effect allows you to bend the pitch down (temporarily lower the note) by a quarter ("1/4 Down") or a semi-tone ("1/2 Down"). Select "1/4 Up" or "1/2 Up" to bend the notes up a quarter or a semi-tone. Select "Off" to switch off the Orchestra section's aftertouch recognition.

The Treble section also contains this parameter. You are thus free to decide whether both the accordion and the orchestral sounds should be affected by aftertouch messages or only one of them.

Note: This aftertouch effect applies to all Orchestra notes that are sounding simultaneously. If you play a chord and then only press down one key of the chord's constituent notes, all notes are bent by the same amount. (MIDI buffs call this "channel aftertouch".)

Note: For organ sounds (8A PercOrgan, 8B JazzOrgan, 9A RotOrgan and 9B Trem Org), aftertouch allows you to alternate between the fast and slow speeds of the Rotary effect. (That effect is automatically assigned to an organ sound when you select it.) The speed switching function cannot be deactivated. You can, however, also add pitch control to this switching function, and so control two functions via the aftertouch.



6.8 Orchestra MIDI TX

This page contains a series of MIDI parameters for the Orchestra section you need to set one by one. See page 72 for details about the MIDI parameters.

These parameters are saved along with all other Set parameters, which allows you to use different MIDI settings for each Set.



SET COMMON parameters



The SET COMMON group contains parameters that apply to all sections, but only within the framework of the currently selected Set, most notably the parameters that specify the sound/character of the Reverb, Chorus and Delay effects.

Important note

Never switch off the FR-7/FR-5 or select another Set before saving the settings you wish to keep, because doing so will erase your changes.

Be aware that the save function explained below *only saves the SET COMMON parameters*. It does not save the settings of the various sections and/or registers.

Saving your changes

Any changes you make can be saved even without using the WRITE function (see p. 77). To avoid losing your changes, it would be a good idea to take advantage of the following automatic routine.

Whenever you press **EXIT/JUMP** after editing a Menu parameter, the FR-7/FR-5 asks you whether you want to save your changes:

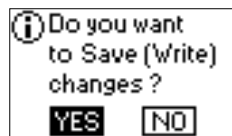

"YES" is selected by default. If you want to save your changes, proceed as described below. (If you don't, turn the **DATA/ENTER** knob to select "NO", then press the **DATA/ENTER** knob.)

Note: You can save your changes later using the WRITE function (see p. 77). But be sure to do so before selecting another Set – and before switching the FR-7/FR-5 off.

To save your changes:

- Press the **DATA/ENTER** knob. The display now responds with:



- If necessary, select another Set by turning the **DATA/ENTER** knob.
For your reference (and to avoid overwriting the wrong SET COMMON settings), the display also shows the name of the target Set memory (below the arrow).
- Press the **MENU/WRITE** button to save your changes. The display now briefly confirms that your settings have been stored:



About the effects parameters

The settings you perform here apply to all sections that use the effect in question. Especially for the Reverb and Chorus effects, it is therefore wise to work with universally usable settings. Try to consider these two as "general" effects that will be used by several parts at once.

The Delay effect, on the other hand, is probably only useful when applied to one part (because too many repeated sounds clutter up the sound image).

The connection of the sections with the effects processors is as follows:

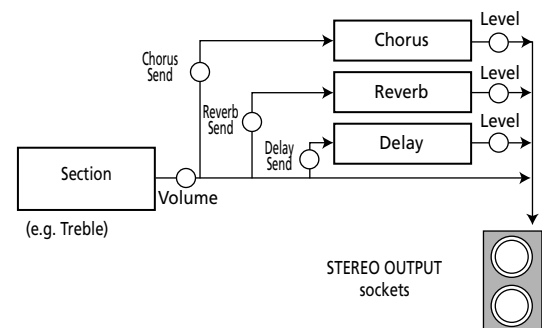

7.1 Reverb Macro Type

This is where you can specify what kind of effect the Reverb processor should generate and how loud it should be.



Note: You can also copy the Reverb (or even all effects) settings from another Set. See page 64.

- If necessary, press the **DATA/ENTER** knob to select the "TYPE" parameter, then rotate the **DATA/ENTER** knob to select an effect type.
The TYPE parameter on this page is a "Macro" function, i.e. it recalls suitable preset values for all Reverb parameters (Pre-LPF~RevPre DlyTm) on the "7.2 Reverb Parameters" page. The Macro therefore also selects a "Character". In many instances, editing only the parameters on this page is enough.

The available options are:

Room1, Room2, Room3	These Reverbs simulate the reverberation of a room. They provide a well-defined spacious reverberation.
Hall1, Hall2	These Reverbs simulate the reverberation of a concert hall with a deeper reverberation than the Room Reverbs.
Plate	This effect type simulates a plate Reverb (a studio device using a metal plate to simulate natural Reverb).

Delay	This is a conventional Delay that produces echo effects.
Panning Dly	This is a special Delay in which the delayed sounds move left and right. It is effective when you are listening in stereo.

Note: Seeing that a delay effect usually only works for one part, we recommend using the dedicated Delay processor for echo effects. That way, the reverb effect can be used to "deepen" the sound field.

- Press the **[DATA/ENTER]** knob to select the "LEVEL" parameter, then rotate the **[DATA/ENTER]** knob to set the Reverb processor's output volume (0~127). The important thing to remember here is that the overall reverb volume depends on three things: the Send level of the various sections, the output level of the Reverb processor and the setting of the **[REVERB]** knob.

If one of them is set to "0", there will be no reverb. If the Send level of a section (Orchestra, for example) is set to "0", only the selected sound will have no reverb. Other sections (whose Send value is different from "0"), however, can still be processed by the Reverb effect. If the LEVEL parameter on this page is set to "0", the Reverb processor is effectively off for all sections.

7.2 Reverb Parameters

This page contains several parameters that need to be selected using the TYPE entry. Be sure to *first* select the parameter you want to change and *then* set its value.



- If necessary, press the **[DATA/ENTER]** knob to select the "TYPE" parameter, then rotate the **[DATA/ENTER]** knob to select a parameter.

■ **Character (0~7)**—*Character* only specifies the Reverb type you need (see the table above). It does not load preset values for the Pre-LPF~RevPreDlyTm parameters. Selecting another Character thus does not reset the other parameter values to their factory settings. A Macro, on the other hand, calls up a Reverb type *and* suitable settings for that effect.

■ **Pre-LPF (0~7)**—A low-pass filter can be applied to the high-frequency range before the signals coming from the various sections are processed by the reverb. Higher values make the Send signals darker, which results in a mellower reverberation. Note that this parameter only applies to the signals that are sent to the Reverb processor. It does not alter the sound of the active sections.

■ **Time (0~127)**—This parameter sets the duration of the reverb effect. Higher values result in longer reverberation.

■ **Level (0~127)**—This parameter sets the output volume of the Reverb processor. It is linked to its namesake on the "7.1 Reverb Macro Type" page. Higher values result in louder reverberation.

■ **Dly Fback (0~127)**—This parameter is only available when you set Character to "6" or "7". It specifies the number of echoes: higher values result in more repetitions.

■ **Pre-Dly T. (0~127)**—This parameter sets the time interval between the original ("dry") signal and the onset of the selected reverb effect. Higher values result in a longer pre-delay time, simulating a larger reverberant space.

- Press the **[DATA/ENTER]** knob to select the "VALUE" parameter, then rotate the **[DATA/ENTER]** knob to set the parameter value (see the indications between brackets).

If you change one of the above parameter values, an "(E)" appears next to the "TYPE" name to signal that you are no longer using the presets of the macro in question.



If you then select another TYPE, however, your changes are lost and replaced by the settings of the newly selected macro.

Note: Simultaneously press the **[UP]** and **[DOWN]** buttons to recall the factory setting for the currently active parameter.

7.3 Chorus Macro Type

Chorus broadens the spatial image of the sound, adding richness. You can choose from 8 types of chorus. The "Macro" label still does what its name implies. Be aware, however, that there is no "Character" parameter on page "7.4".



Note: You can also copy the Chorus (or even all effects) settings from another Set. See page 64.

- If necessary, press the **[DATA/ENTER]** knob to select the "TYPE" parameter, then rotate the **[DATA/ENTER]** knob to select an effect type. The TYPE parameter on this page is a "Macro" function, i.e. it recalls suitable preset values for all Chorus parameters on the "7.4 Chorus Parameters" page. In many instances, editing only the parameters on this page is enough.

The available options are:

Chorus 1~4	These are conventional Chorus effects that add spaciousness and depth to the sound.
FBack Chr	This is a Chorus with a Flanger-like effect and a soft sound.
Flanger	This is an effect that sounds somewhat like a jet airplane taking off or landing.
Short Delay	This is a delay with a short Delay time.
ShortDly FB	This is a short delay with many repeats.

Note: Seeing that a delay effect usually only works for one part, we recommend using the dedicated Delay processor for echo effects. That way, the chorus effect can be used to widen the stereo image.

- Press the **[DATA/ENTER]** knob to select the "LEVEL" parameter, then rotate the **[DATA/ENTER]** knob to set the Chorus processor's output volume (0~127).

The important thing to remember here is that the overall chorus volume depends on three things: the Send level of the various sections, the output level of the Chorus processor and the setting of the **[CHORUS]** knob.

If one of them is set to "0", there will be no chorus. If the Send level of a section (the BASS section, for example) is set to "0", only that section will have no chorus. Other sections (whose Send value is different from "0"), however, can still be processed by the Chorus effect. If the LEVEL parameter on this page is set to "0", the Chorus processor is effectively off for all sections.

7.4 Chorus Parameters

This page contains several parameters that need to be selected using the TYPE entry.

Be sure to *first* select the parameter you want to change and *then* set its value.



- (1) If necessary, press the **[DATA/ENTER]** knob to select the "TYPE" parameter, then rotate the **[DATA/ENTER]** knob to select a parameter.

- **Pre-LPF (0~7)**—A low-pass filter can be applied to the high-frequency range before the signals coming from the various sections are processed by the chorus. Higher values make the Send signals darker, resulting in a mellower chorus sound. Note that this parameter only applies to the signals that are sent to the Chorus processor. It does not alter the sound of the active sections.

- **Level (0~127)**—This parameter sets the output volume of the Chorus processor. It is linked to its namesake on the "7.3 Chorus Macro Type" page. Higher values result in a more prominent Chorus effect.

- **Feedback (0~127)**—This parameter sets the level at which the Chorus sound is re-input (fed back) into the Chorus. By using Feedback, a denser Chorus sound can be created. Higher values result in a greater feedback level.

- **Delay (0~127)**—This parameter sets the delay of the Chorus effect. Higher values will cause greater deviation in pitch of the chorus sound.

- **Rate (0~127)**—This parameter sets the speed (frequency) at which the chorus sound is modulated. Higher values result in faster modulation.

- **Depth (0~127)**—This parameter sets the depth at which the chorus sound is modulated. Higher values result in a more pronounced modulation.

- **Chr ▶ Rev (0~127)**—This parameter sets the amount of chorus sound that is sent to the Reverb processor. The value "127" effectively allows you to connect the Chorus

and Reverb effects in series (Chorus before Reverb). If you do not want the chorus signal to be processed by the Reverb effect, set this value to "0".

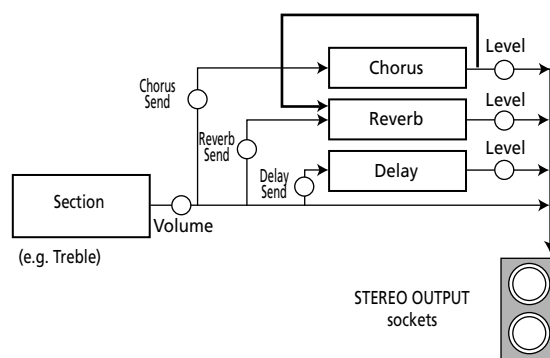

- **Chr ▶ Dly (0~127)**—This parameter sets the amount of chorus sound that is sent to the Delay processor. Higher values result in more sound being sent. The value "127" effectively allows you to connect the Chorus and Delay effects in series (Chorus before Delay). If you do not want the chorus signal to be processed by the Delay effect, set this value to "0".

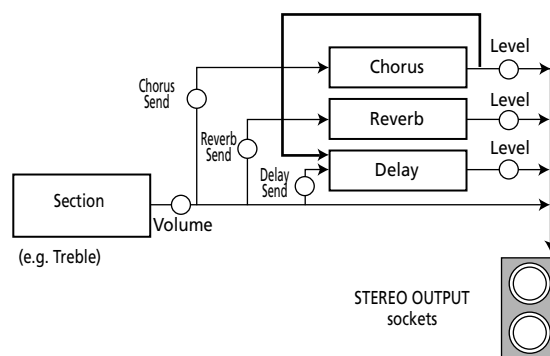

- (2) Press the **[DATA/ENTER]** knob to select the "VALUE" parameter, then rotate the **[DATA/ENTER]** knob to set the value (see the indications between brackets above).

If you change one of the above parameter values, an "(E)" appears next to the "TYPE" name to signal that you are no longer using the presets of the macro in question.

If you then select another TYPE, however, your changes are lost and replaced by the settings of the newly selected macro.

Note: Simultaneously press the **[UP]** and **[DOWN]** buttons to recall the factory setting for the currently active parameter.

7.5 Delay Macro Type

A delay effect creates echoes. It can also broaden a sound by adding a slightly delayed copy to the original sound (a technique often used for rock-'n'-roll songs and in Karaoke bars). The "Macro" label still does what its name implies. Be aware, however, that there is no "Character" parameter on page "7.6".



Note: You can also copy the Delay (or even all effects) settings from another Set. See page 64.

- (1) If necessary, press the **[DATA/ENTER]** knob to select the "TYPE" parameter, then rotate the **[DATA/ENTER]** knob to select an effect type.

The TYPE parameter on this page is a "Macro" function, i.e. it recalls suitable preset values for all Delay parameters on the "7.6 Delay Parameters" page. In many instances, editing only the parameters on this page is enough.

The available options are:

Delay 1~3	These are conventional Delays. 1, 2 and 3 have progressively longer delay times.
Delay 4	This is an effect with a rather short delay time (a kind of "slap back" effect).
Pan Delay 1~3	The repetitions move between left and right. This is effective when listening in stereo. 1, 2 and 3 have progressively longer delay times.
Pan Delay 4	This is a rather short delay with the echoes moving between left and right. It is effective when listening in stereo (a kind of stereo "slap back" effect).
Delay ▶ Rev	Reverb is added to the Delay sound which moves between left and right. It is effective when listening in stereo.
Pan Repeat	The delay signal moves between the left and right channels, yet the stereo position is different from the effects listed above. It is effective when listening in stereo.

- (2) Press the **[DATA/ENTER]** knob to select the "LEVEL" parameter, then rotate the **[DATA/ENTER]** knob to set the Delay processor's output volume (0~127). The overall delay volume depends on three things: the Send level of the various sections, the output level of the Delay processor and the setting of the **[DELAY]** knob.

If one of them is set to "0", there will be no delay effect. If the Send level of a section (the Treble section, for example) is set to "0", the sound of that section is not repeated. Other sections (whose Send value is different from "0"), however, can still be processed by the Delay effect. If the LEVEL parameter on this page is set to "0", the Delay processor is effectively off for all sections. This parameter is connected to the **[DELAY]** knob.

7.6 Delay Parameters

This page contains several parameters that need to be selected using the TYPE entry. Be sure to *first* select the parameter you want to change and *then* set its value.



- (1) If necessary, press the **[DATA/ENTER]** knob to select the "TYPE" parameter, then rotate the **[DATA/ENTER]** knob to select a parameter.

■ **Pre-LPF (0~7)**—A low-pass filter can be applied to the high-frequency range before the signals coming from the various sections are processed by the Delay processor. Higher values make the Send signals darker, resulting in a mellower delay sound. Note that this parameter only applies to the signals that are sent to the Delay processor. It does not alter the sound of the active sections.

■ **Level (0~127)**—This parameter sets the overall volume of the three delay lines (center, left and right). Higher values result in a louder delay effect.

■ **Time C (0.1~1000)**—The Delay effect of the FR-7/FR-5 allows you to set three delay times: center (C), left (L) and right (R). "Time C" sets the delay time of the Delay located at the center.

■ **Time L/R (4%~500%)**—These parameters sets the delay time of the left- or right-channel delay line as a percentage of the central Delay. The value "100%" means that the left or right delay repeats at the same speed as the center delay (see above).

■ **Level C/L/R (0~127)**—These parameters set the volume of the central, left and right delays individually, allowing you to create the desired "mix".

■ **Feedback (-64~0~+63)**—This parameter specifies the number of times the delay will repeat. If you select "0", the delay will not repeat. Higher values result in more repetitions. With negative (-) values, the center delay will be fed back with inverted phase. This is especially effective for small "Time C" values.

■ **Dly ▶ Rev (0~127)**—This parameter sets the amount of delay sound that is sent to the Reverb. Higher values mean that the echoes will be more prominent in the reverb signal. Be careful not to overdo this effect because it tends to blur the sound image.

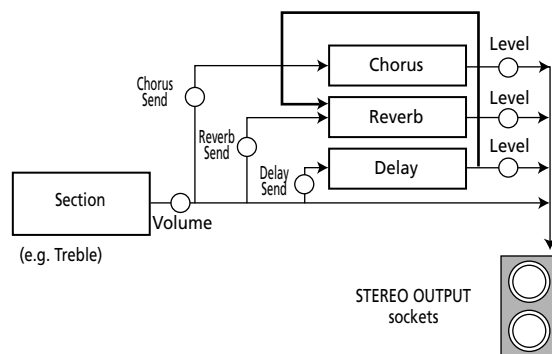

If you change one of the above parameter values, an "(E)" appears next to the "TYPE" name to signal that you are no longer using the presets of the macro in question.

If you then select another TYPE, however, your changes are lost and replaced by the settings of the newly selected macro.

7.7 Name

This function allows you to name the selected Set (8 characters). It would be a good idea to use the name of the instrument you "built" using the TREBLE, BASS, FREE BASS, etc., group parameters – or the name of the Song you wish to use this Set for.



- (1) Select the character position (indicated by a dark square) by pressing **UP** (previous character), **DOWN** (next character) or the **DATA/ENTER** knob (next character).
- (2) Turn the **DATA/ENTER** knob to select the desired character.
 - Press **UP** and **DOWN** simultaneously to erase the currently selected character (it will become a space). Example: To replace the period (".") in "Fr.Folk" with a space ("Fr Folk"), position the cursor on the "." and simultaneously press **UP/DOWN**.
 - To insert a space before the currently selected character and push all subsequent characters one position to the right, select the character that should follow the space, then press and hold **UP**. Example: To insert a space after the "." in "Fr.Folk" (creating the name "Fr. Folk"), position the cursor on the second "F" and hold down **UP** for a while.

Note: If the name already contains 8 characters ("Bandoneo"), the last character is erased (example: "Band one").

- To delete the character indicated by the cursor and move subsequent characters one position to the left, select it (example: "Fr.Folk") and press and hold **DOWN** ("FrFolk").

7.8 Master Bar Recall

This parameter allows you to choose the Treble register (1~14) that can be activated by pressing the Master bar. Note that this is only possible while the Treble section is in Solo mode (page 25) or while the Orchestra part is set to "CANCEL".



In all other cases (Dual, High, Low modes), the Master bar is indeed used to mute the Orchestra part. And in Solo mode, the first press allows you to return from the Orchestra (if it's on) to the Treble section.

7.9 Icon

This parameter allows you to assign an icon to your Set, which is displayed above its name on the Main page. In most cases, you will probably choose a picture that somehow illustrates the contents of your settings, but that is entirely up to you. The FR-7/FR-5 contains 40 preset icons (stored in its internal memory).



SYSTEM parameters



The **SYSTEM** group contains parameters that are related to all Sets and all sections: they apply to the FR-7/FR-5 as a whole. See pages 35 and 37 for how to select and adjust the parameters.

Press **UP** and **DOWN** simultaneously to select the value that is indicated as "Default setting".

Saving your changes

Any changes you make can be saved even without using the WRITE function (see p. 77). To avoid losing your changes, it would be a good idea to take advantage of the following automatic routine.

Whenever you press **EXIT/JUMP** after editing a Menu parameter, the FR-7/FR-5 asks you whether you want to save your changes:

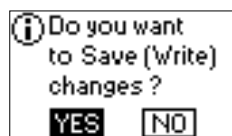

"YES" is selected by default. If you want to save your changes, proceed as described below. (If you don't, turn the **DATA/ENTER** knob to select "NO", then press the **DATA/ENTER** knob.)

To save your changes:

- (1) Press the **DATA/ENTER** knob. The display now responds with:



Note: The GLOBAL page shows all parameters that can be saved to the Global memory (there is only one such memory): the Master Tune and Scale Tune parameters of the TUNING group (the Transpose setting is never saved) as well as the SYSTEM and MIDI groups.

- (2) Press the **WRITE** button to save your changes. The display briefly shows a confirmation:



Note: If you selected "NO", the edited Global settings will be used until you switch off the FR-7/FR-5 (or change them again).

8.1 LCD Contrast

(1~7, Default setting: 4) The information in the LCD display may be difficult to view after turning on your FR-7/FR-5 or after extended use. Your viewing angle and the current lighting conditions can also affect the appearance of the display.

In such cases, use this parameter to adjust the contrast. The smaller the value, the darker the "background" becomes.



8.2 Parameter Access

This function was already discussed on page 18: it allows you to specify how many MENU parameters should be accessible. "Full" mode is ideal for in-depth programming of your FR-7/FR-5. "Easy" mode appears a sensible choice for quick adjustments during a concert, performance, etc.

Note that the FR-7/FR-5 also provides functions you can set without even entering its MENU structure (see p. 28). They have the advantage that you do not need to specify whether or not to save them (so that you won't have to keep your audience waiting). If you do want to save those settings, press the **WRITE** button.



8.3 Bellows Curve

(Fixed Low, Fixed Med, Fixed High, X-Light, Light, Standard, Heavy, X-Heavy) This parameter allows you to specify how the FR-7/FR-5 should react to the bellows' movements. You may remember that there are several functions that can be controlled via the strength/speed with which you push or pull the bellows (2.7 Bellows Detune, 3.6 Bellows Detune, 3.5 Reed Growl, 4.6 Bellows Detune, 6.3 Bellows Detune).

If you think those parameters do not respond the way you would like them to, try another curve that better "translates" your movements.

There are three "Fixed" curves that always use the same value, no matter how hard or lightly you push/pull the bellows (no dynamic control). "Low" means that a low value is used, "Med" represents a medium value and "High" a high value.

The remaining settings do depend on the strength with which you push/pull the bellows, but in different ways: "Light" means that you do not need to push/pull hard to achieve a meaningful effect. "X-Light" requires even less strength (the "X" stands for "extra"). "Standard" refers to a normal response (or so we believe). "Heavy" provides a greater variety of nuances and "X-Heavy" is even more detailed. It would be a good idea to select each curve without the "Fixed" addition, play a few notes, select the next curve, etc. until you find the response that feels just right.



8.4 Pedal Controller

This page allows you to assign functions to the FBC-7's footswitches. As you will notice below, there are also functions for remotely controlling external instruments, like a DisCover 5M, an arranger module or any other sequencer that understands the messages transmitted by the FBC-7.

Note: The assignments you program here are only meaningful if you connect the FR-7/FR-5 to the supplied FBC-7.

- (1) If necessary, press the **DATA/ENTER** knob to select the "SWITCH" parameter, then rotate the **DATA/ENTER** knob to select the footswitch on the FBC-7 whose function you wish you define.



- (2) Press the **DATA/ENTER** knob to select the "ASSIGN" parameter, then rotate the **DATA/ENTER** knob to select one of the following functions:

- **Set Up/Set Down**—The footswitch allows you to select the next (Down) or previous (Up) Set memory. After selecting Set 01 (or 40), pressing the footswitch again takes you to Set 40 (or 01). These are the default functions of footswitches [1] and [2].

Note: There is also a function that allows you to assign a specific Set number to a footswitch (see "Set 1~40" below).

- **Regist Up/Regist Dwn**—The selected footswitch allows you to select the next (Down) or previous (Up) Treble register. If you combine this with the "2.12 Bass Link" and "2.13 Orchestra Link" parameters, this allows you to reconfigure almost all sections simply by pressing this footswitch.

Note: There is also a function that allows you to assign a specific register number to a footswitch (see "Register 1~14" below).

- **Treble Sust**—The footswitch can be used to hold the Treble notes (accordion) transmitted via MIDI whose keys you are holding down when you press the footswitch. You can then release the keys – the notes go on sounding until you release the footswitch. This is for MIDI control only.

- **Bass Sust**—The footswitch can be used to hold the bass notes of the Bass section transmitted via MIDI (but not the chords). This is for MIDI control only.

- **Chord Sust**—The footswitch can be used to hold the chord notes of the Bass section transmitted via MIDI (but not the bass notes). This is for MIDI control only.

- **Orch Sust**—The footswitch can be used to hold the Orchestra notes of the Treble section. This also applies to the note messages transmitted via MIDI. At the same time, the internal Orchestra notes are held (if that section is on).

- **Orch Bs Sust**—The footswitch can be used to hold the Orchestra notes of the Bass section transmitted via MIDI. This is for MIDI control only.

- **Orch On/Off**—The footswitch can be used to switch the Orchestra Treble section on and off. This has no effect on the Orchestra's mode setting, nor can you specify which Orchestral sound should be used. (You can, however, use "2.13 Orchestra Link" for that.)

■ **Start/Stop**—This setting only makes sense if you connect the FBC-7's MIDI OUT socket to the MIDI IN socket of an external sequencer, arranger module, drum machine or DisCover 5M. Pressing the footswitch once will cause the external device to start playback. Obviously, you need to load the desired song, select a Music Style, etc., beforehand. Press the footswitch again to stop playback.

■ **Intro**—This setting only makes sense if you connect the FBC-7's MIDI OUT socket to the MIDI IN socket of an arranger module. In this case, the footswitch can be used to select the "Intro" pattern of the active Music Style.

Note: Arranger instruments of other manufacturers may not understand this message. If in doubt, see their MIDI implementation section for details. The MIDI message transmitted by this footswitch is PC83 (program change) on MIDI channel 10.

■ **Fill Up**—This setting only makes sense if you connect the FBC-7's MIDI OUT socket to the MIDI IN socket of an arranger module. In this case, the footswitch can be used to select a fill-in pattern of the active Music Style that selects a more richly orchestrated accompaniment pattern upon completion.

Depending on the arranger instrument you're controlling, you could use this footswitch up to three times to jump to the most complex level. If you then press the footswitch again, however, nothing happens. You thus cannot cycle back to the lowest level (which is called "Original" on older Roland arranger instruments).

Note: Some arranger instruments provide only two accompaniment levels.

Note: Arranger instruments of other manufacturers may not understand this message. The MIDI message transmitted by this footswitch is PC81 (program change) on MIDI channel 10.

■ **Fill Down**—This setting only makes sense if you connect the FBC-7's MIDI OUT socket to the MIDI IN socket of an arranger module. In this case, the footswitch can be used to select a fill-in pattern of the active Music Style that selects a more scarcely orchestrated accompaniment pattern upon completion.

Certain arranger instruments provide four accompaniment levels, so that you could use this footswitch up to three times to return to the most fundamental level (please see the manual of the arranger instrument you're controlling to find out how many levels it provides). If you then press

the footswitch again, however, nothing happens. You thus cannot cycle back to the highest level (which is called "Variation" on older Roland arranger instruments).

Note: Some arranger instruments provide only two accompaniment levels.

Note: Arranger instruments of other manufacturers may not understand this message. The MIDI message transmitted by this footswitch is PC82 (program change) on MIDI channel 10.

■ **Ending**—This setting only makes sense if you connect the FBC-7's MIDI OUT socket to the MIDI IN socket of an arranger module. The footswitch can be used to select the "Ending" pattern of the active Music Style.

Note: Arranger instruments of other manufacturers may not understand this message. If in doubt, see their MIDI implementation section for details. The MIDI message transmitted by this footswitch is PC84 (program change) on MIDI channel 10.

■ **Set 1~40**—The selected footswitch can be used to recall the specified Set (i.e. the Set whose number you choose). Consider using "Set Up/Set Down" if you prefer to cycle through all available Sets.

■ **Register 1~14**—The footswitch can be used to recall the selected Treble register. That is why you must specify a number here. Consider using "Regist Up/Regist Dwn" if you prefer to cycle through all available registers.

8.5 Bass & Chord Mode

(Default setting: 2 Bass Rows)

This parameter allows you to specify the number of button rows for playing bass notes. The default is 2 bass rows and 4 chord rows. By selecting "3 Bass Rows", you thus gain 20 bass buttons (an entire row) and lose the "dim" chord buttons – but that may just be more convenient for you. See also the illustration below.



Note: The FR-7/FR-5 is supplied with several reference caps designed to help you locate the bass and chord buttons without looking at them. See also page 22.

8.5 Bass & Chord Mode

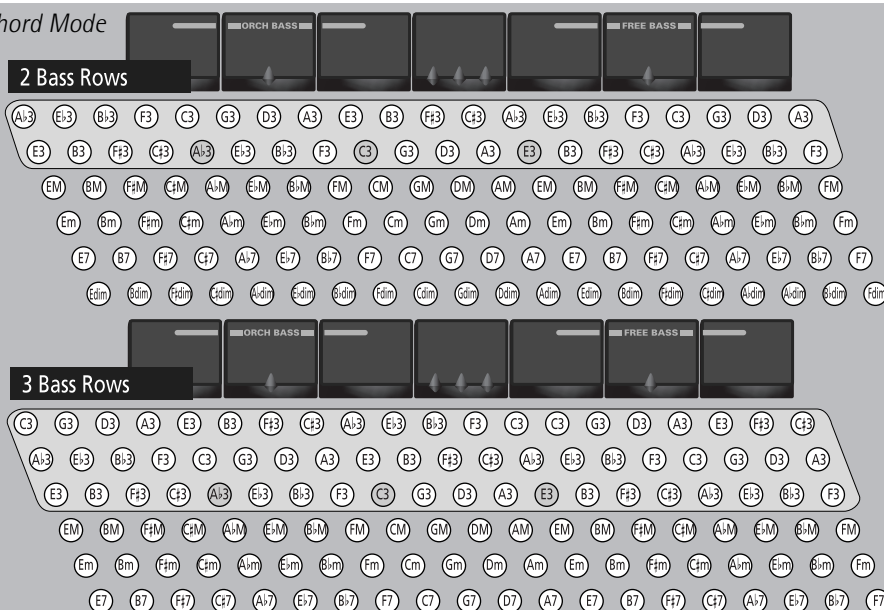

8.6 Free Bass Mode

Minor 3rd

Bajon

5th

N. Europe

(C3= note number 48)

Note: The note names on the bass buttons correspond to the MIDI note numbers. The note range of the Bass part is 1 octave.

Note: The actual sound range depends on the type of reed and footage.

8.6 Free Bass Mode

(Default setting: Minor 3rd) This parameter allows you to choose the note system used in Free Bass mode. We already mentioned that there are a vast number of accordion varieties. The same is true of Free Bass systems.

Your FR-7/FR-5 contains the most popular ones. Be aware that the system you select here is only used when you activate the FR-7/FR-5's Free Bass mode. It is of no consequence for the "regular" Bass mode. See the illustration on the next page for the note assignments.

Note: The FR-7/FR-5 is supplied with several reference caps designed to help you locate the bass buttons without looking at them. See also page 22.

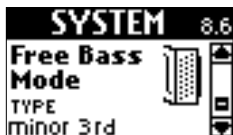

8.7 Stereo Width

(Full, -1~-63, Default setting: -15) As stated on p. 14, much care has been taken to provide a natural stereo image for the accordion sounds. If you think the stereo image is too wide for comfort (or if you prefer to set the Pan controls on your mixing console differently), you can use this parameter to reduce the stereo image.

"Full" means that the original stereo image is used, while "-63" corresponds to an extremely narrow stereo image. All other values represent slight (or increasingly drastic) reductions of the stereo width.



8.8 Auto Power OFF

(Disabled, 10 min, 15 min, 20 min, Default setting: 10 min)
This parameter allows you to specify how long the FR-7/FR-5 should wait before deciding that



you won't be using it for a while. If you have ever worked with a computer, you may remember that a similar function is called "sleep", "energy saver" or the like.

Obviously, this is meant to preserve battery power and so this function only applies when the FR-7/FR-5 is not connected to the FBC-7. To "wake" the FR-7/FR-5 after it has fallen asleep, press its **[POWER]** button. Select "Disabled" to switch this function off.

Note: See p. 32 for how to recharge the battery.

8.9 Startup

This page contains several parameters that allow you to specify what the FR-7/FR-5 should do when you switch it on.



Be sure to *first* select the parameter you want to change and *then* set its value.

- If necessary, press the **[DATA/ENTER]** knob to select "TYPE", then rotate the **[DATA/ENTER]** knob to choose the parameter you want to set. The possibilities are:

Parameter	Settings	Meaning
Set	1~40	Allows you to specify which Set should be loaded at power-on.
Orchestral Link	On, Off	Allow you to specify which Link function (see p. 42) should be activated at power-on: Orchestral Link, Bass Link, both (both "On") or neither (both "Off").
Bass Link	On, Off	

- Press the **[DATA/ENTER]** knob to select the "ASSIGN" parameter, then rotate the **[DATA/ENTER]** knob to select the desired setting.

8.10 Startup Name

Here comes a parameter that may prove invaluable if you regularly play with other V-Accordion users. It allows you to enter a short message (your name, for example) that is displayed each time you switch the FR-7/FR-5 on. If you also own a cell phone, this parameter probably sounds familiar.



See "Entering names" on p. 40 for details. You can enter up to 8 characters.

Here is what your message could look like (it is displayed during ±2 seconds each time the FR-7/FR-5 is switched on):



8.11 Orch. Bass Touch

(Off, Low, Medium, High, Bellows, Default setting: Medium)

This parameter allows you to specify the velocity sensitivity of the bass buttons. As the name implies, this setting is only used by the following Orchestra Bass sounds: "1 Acoustic", "3 Fingered", "4 Fretless", "5 Picked", "7 Tuba Mix".



Select "Off" if you do not wish to play the selected sound dynamically. "Low" means that even relatively light button presses already allow you to play loud notes. "High" represents the most responsive velocity curve that requires a considerable amount of strength for fortissimo notes, but it also provides more expressive options.

"Bellows" means that the selected Orchestra Bass sound is controlled by the bellows movements – i.e. not the velocity values generated by the bass buttons.

UTILITY parameters



The **UTILITY** group contains three kinds of parameters: those that keep you informed (to check the battery status), several parameters that allow you to copy settings and three parameters for archiving your settings via MIDI. See pages 35 and 37 for how to select and adjust the parameters.

9.1 Battery Status

The FR-7 comes with a Ni-Mh battery that allows you to use it without connecting it to the supplied FBC-7. The FR-5 provides the same battery compartment as the FR-7, but the battery is an option. (As long as you do not purchase such a battery, you need to connect the FR-5 to the supplied FBC-7.)



Note: There is no "EDIT" page here, because there is no parameter you can set.

Depending on how the FR-7/FR-5 is powered, the display shows one of the following messages:

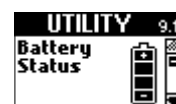

This message means that the FR-7/FR-5 is powered by the battery in its compartment. The battery icon shows how much power is left.

It would be a good idea, however, to stop by this page before you go on stage or start playing, because what you see then might just convince you to use the FBC-7.



This message means that the battery is being recharged by the FBC-7. This is not something that is performed automatically. You need to connect the FR-7/FR-5's "TO FBC-7" socket to the

"TO FR-7/FR-5 V-ACCORDION" socket on the FBC-7 and press the BATTERY CHARGER button (so that it lights). The battery icon indicates the amount of energy already available.

When the battery is fully charged, the display briefly shows a "Recharge Complete" message.

While the FR-7/FR-5 is connected to the FBC-7, the latter supplies the power to your V-Accordion (the battery in the FR-7/FR-5's compartment is therefore bypassed). However, while the BATTERY CHARGER button lights, the FR-7/FR-5 cannot be used, because the FBC-7 "concentrates" on recharging the FR-7/FR-5's battery.



This message means that the FR-7/FR-5 contains a battery, which is not used, because the FR-7/FR-5 is connected to the FBC-7. The FBC-7

therefore supplies the power to your V-Accordion. The battery icon nevertheless informs you about the battery's current charge.



This message means that the FR-7/FR-5 contains no battery. It is connected to the FBC-7, however (otherwise you would not be able to switch it on). In the case of an FR-5 without an optional battery, this is the only message you'll ever see.

9.2 Copy ALL Effects

This parameter allows you to copy the settings of all three effects processors from one Set to another. This may help you save time, because the effects processors contain an impressive number of parameters. **Careful:** there are also parameters that allow you to copy just the Reverb, Chorus or Delay settings. Do not use this parameter if you only wish to reuse the Reverb settings of another Set, for example.



- (1) After selecting this page, press the **DATA/ENTER** knob until the following page appears:



- (2) Use the **DATA/ENTER** knob to select the Set whose effects settings you wish to copy to the current Set.

You can also select another memory for "TO" if you want to copy the settings to another Set than the one that is currently selected.

- (3) Press **MENU/WRITE** to copy the settings. The display confirms this operation:



9.3 Copy Reverb, 9.4 Copy Chorus, 9.5 Copy Delay

These three parameters allow you to copy the Reverb, Chorus or Delay settings of another Set to the currently selected Set. Unlike the "9.2 Copy ALL Effects" parameter, which copies all effects settings, these three parameters only import the selected processor's settings. That way, you can use the Reverb settings of Set 1, the Chorus settings of Set 10 and the Delay settings of Set 28 in Set 5.

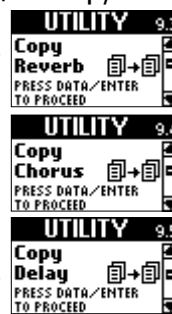

- (1) After selecting the page that corresponds to the effects processor whose settings you wish to copy, press the **DATA/ENTER** knob until the relevant page appears:



- (2) Use the **DATA/ENTER** knob to select the Set whose effects settings you wish to copy to the current Set.

You can also select another memory for "TO" if you want to copy the settings to another Set than the one that is currently selected.

- (3) Press **MENU/WRITE** to copy the settings. The display confirms this operation:



9.6 Copy SET

This parameter allows you to copy the settings of one Set to another Set memory. It copies everything related to a Set: the Common parameters (including the effects) as well as the parameters of the various sections (Treble, Orchestra, Bass, etc.).



Warning: All settings of the target memory are overwritten. It might be a good idea to archive the target Set using "9.8 Bulk Dump SET" before proceeding.

- (1) On the page shown above, press the **DATA/ENTER** button.

The display now changes to:



- (2) Press the **[DATA/ENTER]** knob to select the "FROM" parameter, then turn it to select the Set whose settings you wish to copy.
By default, the FR-7/FR-5 selects the number of the Set you are currently using.
- (3) Press the **[DATA/ENTER]** knob to select the "TO" parameter, then turn it to select the Set memory to which the settings should be copied.
Carefully check whether you have selected the correct Set memories, then...
- (4) Press **[MENU/WRITE]** to copy the settings.
The display confirms this operation:



9.7 Bulk Dump ALL, 9.8 Bulk Dump SET

These two functions allows you to transmit all of the FR-7/FR-5's settings or just the settings of the currently selected Set to an external MIDI device (which could be a second FR-7/FR-5). See page 75 for details.

9.9 Restore SET

This function allows you to load the settings of one of the pre-programmed Sets into the currently selected Set memory.



Warning: This command overwrites all settings of the current Set, i.e. the parameters of the following sections: 2. Treble Edit, 3. Bass Edit, 4. Free Bass Edit, 5. ORC Bass Edit, 6. Orchestra Edit and 7. Set Common.

It can come in handy, though, if you want to return to one of the factory Sets and use it as is or as a starting point for new edits.

- (1) On the page shown above, press the **[DATA/ENTER]** button.

The display now changes to:



- (2) Rotate the **[DATA/ENTER]** knob to select the factory Set you want to load.
- (3) Press **[MENU/WRITE]** to load the settings.
The display confirms this operation:



7. MIDI functions

Your FR-7/FR-5 also transmits and receives MIDI data. In this chapter we'll look at what MIDI is and does and which MIDI functions are available on the FR-7/FR-5.

IMPORTANT REMARK: To take advantage of the FR-7/FR-5's MIDI functions, you must connect it to the supplied FBC-7, because the FR-7/FR-5 itself has no MIDI sockets.

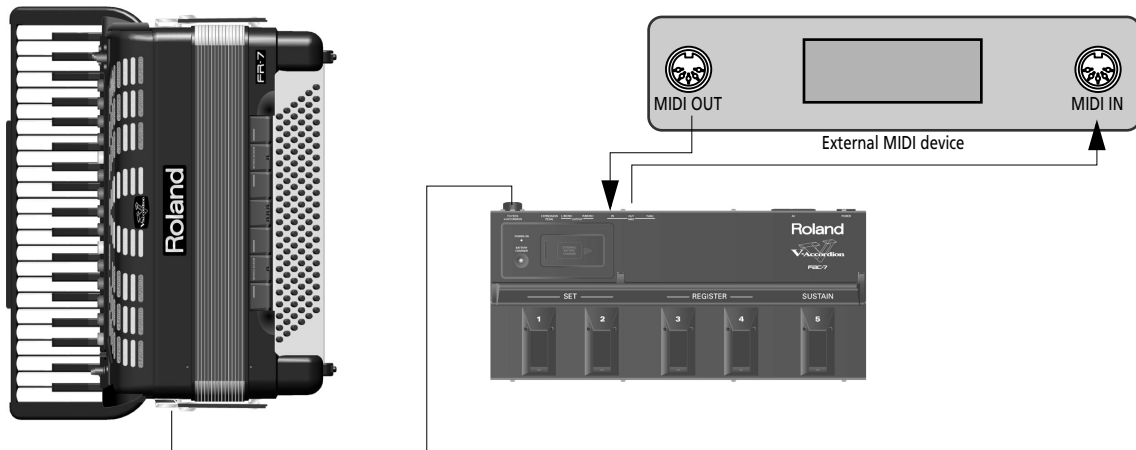

About MIDI

Even though your FR-7/FR-5 is already a remarkably flexible instrument (quite unlike any other accordion available today), you may also want to use it with other MIDI-compatible instruments, sequencers and computers to record your performances in the same way as keyboard players, drummers, guitarists, etc. have been doing for a while.

Another important application for the FR-7/FR-5's MIDI functions is controlling an arranger or DisCover 5M module that supplies the accompaniment. "Arranger modules" (like the Roland RA-800) use short accompaniment patterns that can be selected in realtime and whose key depends on the note information they receive. You can select those patterns by assigning the corresponding MIDI messages to the FBC-7's footswitches (see p. 60), so that you do not have to stand or sit next to your arranger module.

The DisCover 5M, on the other hand, works with Standard MIDI Files. By programming Song Chains on the DisCover 5M, you can prepare your entire set list.

Both module types (and all MIDI-compatible sound sources) also allow you to use the FR-7/FR-5's Treble and Bass keyboards for playing sounds the FR-7/FR-5 does not provide.

This is possible thanks to a common language for musical applications, which is called "**Musical Instrument Digital Interface**" or "**MIDI**" for short. MIDI has a lot in common with the internet: you can link one or several instruments to one another via a cable (but you don't need a telephone line).

You can also use the FR-7/FR-5 as "master keyboard", i.e. an instrument that transmits MIDI messages to a device (or software program) that can record MIDI messages. Such a device or program is called a "sequencer". To take advantage of the FR-7/FR-5's MIDI functions, you must connect the FBC-7 as follows:

MIDI OUT: This socket transmits messages describing actions (such as playing on a keyboard) to the MIDI IN jack on the external device. The receiving MIDI device executes the incoming MIDI messages and plays notes, selects other sounds, etc.

MIDI IN: This socket receives the MIDI messages transmitted by an external MIDI device.

MIDI THRU: This socket retransmits the MIDI messages received via the FBC-7's MIDI IN port. You can connect it to the MIDI IN port of another MIDI device.

Note: The MIDI THRU port does not transmit the MIDI messages generated by the FR-7/FR-5. Those messages are only sent to the FBC-7's MIDI OUT port.

MIDI can simultaneously transmit and receive messages on 16 channels, so that up to 16 instruments (or parts of a module or synthesizer) can be controlled. Nowadays, most instruments –like your FR-7/FR-5– are multitimbral, which means that they can play several musical parts with different sounds. This requires the use of several MIDI channels. The FR-7/FR-5, for instance, has a Treble, a Bass, an Orchestra Treble and an Orchestra Bass section that can be played simultaneously. They can transmit and receive on different channels.

The FR-7/FR-5's sections use the following MIDI channels:

Part	Channel
Treble	1
Bass/Free Bass	2
Chord	3
Orchestra (Treble)	4
Orchestra Bass	5
Basic channel (for selecting Sets)	13

As you see, there are separate channels for the chord and bass buttons, even though they both belong to the Bass section. That separation may look distracting at first, but it actually makes sense. It allows you to use the bass buttons for controlling an external bass sound, while the chord buttons could control a piano sound, for example. If they used the same MIDI channel, the bass line would have to be played by a piano or the chords would be played by a bass sound (unless you own a MIDI instrument that allows you to program MIDI note ranges for incoming MIDI messages).

Working with a sequencer and other tone generators

The FR-7/FR-5 can be used as "input device" for recording your music. In the case of a keyboard instrument, such a device is usually called a "master keyboard". For other kinds of MIDI input sources, the term "controller" is used. There are actually two kinds of master keyboards: those that only transmit MIDI data and contain no tone generator, and those that can also be used for playing back music (synthesizers, digital pianos, organs, etc.).

Sequencers do not record the audio of the notes you play. They only register "events" whose position and distance specify when the notes are to be played. The sequencer as such usually cannot sound what you record – you need an instrument with a tone generator for that. A sequencer must therefore be connected to an electronic sound source, like your FR-7/FR-5, for example.

The FR-7/FR-5 can be used for two things: to "input" new parts (i.e. MIDI events) and to play them back.

When you play on the FR-7/FR-5's keyboards, it sends MIDI data to the FBC-7's MIDI OUT socket. That socket must be connected to the sequencer's MIDI IN port. MIDI data always go from OUT to IN:

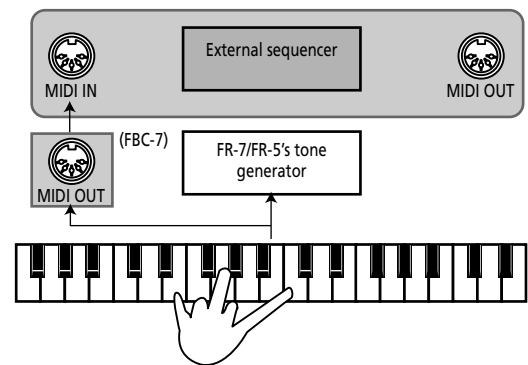

If the FR-7/FR-5 is used as tone generator for an external sequencer, you must connect the sequencer's MIDI OUT socket to the FBC-7's MIDI IN port (because MIDI data always go from OUT to IN).

Though you can also play the FR-7/FR-5 from another MIDI instrument, we do not really recommend doing so, because your V-Accordion has far more versatile performance functions than any other MIDI controller available today: the FR-7/FR-5 translates all known accordion techniques and physical effects into MIDI messages to precisely reproduce the natural behavior of an acoustic accordion. Conversely, it might be interesting to try out the FR-7/FR-5 with a Roland Fantom-XR module (or a DisCover 5M), because the FR-7/FR-5's countless expressive "gizmos" are bound to further enhance the stunning realism of the module's sounds. If you use the FR-7/FR-5 as a MIDI controller while recording a sequence, all actions you perform on the FR-7/FR-5 (including the bellows pressure strength) are included in the recorded part. They can therefore be sent back to the FR-7/FR-5 (by the sequencer) – and then, all expression details are preserved. Be aware, however, that you also need a versatile sound source (like the FR-7/FR-5's) to use the recorded MIDI events to their full potential.

A "sequencer" can also be a software program running on a computer. Most computers do not have MIDI sockets to which you can connect the FBC-7's MIDI IN and OUT sockets. You therefore also need one of the following:

- A sound card with a joystick port to which you can connect MIDI cables;
- A card called a "MIDI interface" that is installed in your computer;
- An external device to which you connect the MIDI cables coming from the FBC-7 at one end and whose other end is connected to the computer's USB port (companies like Edirol, www.edirol.com, offer several models with a varying number of inputs and outputs).

You also need a software program that allows you to record and play back your music. Such programs are available from companies like Cakewalk. Please ask your

Roland dealer for details. And finally, you may need to install applications called "drivers" on your computer to ensure that it can talk and listen to the MIDI interface.

Final note regarding sequencers

If you use the FR-7/FR-5 as MIDI controller for recording new songs, there is one more thing you need to be aware of. Always ask yourself which MIDI sound source should play back the part you are recording.

- If the FR-7/FR-5's tone generator is **not** used for the part you are recording, you need to connect the external module's MIDI IN socket to the sequencer's MIDI OUT port and activate the sequencer's "MIDI Soft Thru" function:

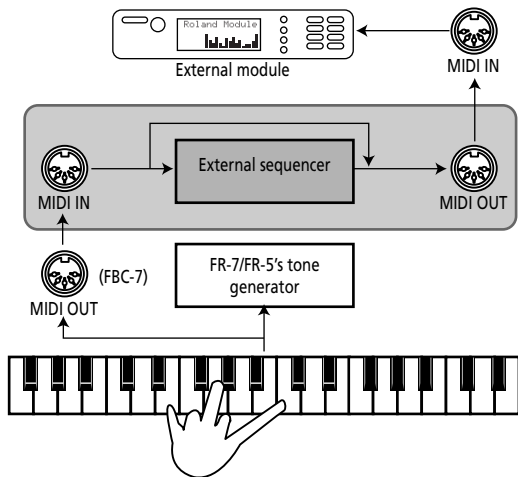

Note that this is only necessary for recording new material. You do not have to worry about them during playback.

The FR-7/FR-5, for its part can only either *transmit* MIDI messages or *receive* them (but not both simultaneously). There is thus nothing special you need to do and that needs to be changed back later. It only receives messages if the "Ext" function is on (see page 70).

Global MIDI parameters

The parameters discussed here are part of a separate mode (called "MIDI"). Their settings, however, are saved to the FR-7/FR-5's Global memory (there is no separate MIDI memory). Let us first look at the parameters that apply to all Sets. See page 72 for the parameters that can be set for each section individually and saved to a Set.

MIDI channel numbers (10.1 RealTime RX-TX)

The table on page 67 specifies the default MIDI channel assignments the FR-7/FR-5 uses. Those choices are based on how most accordion players prefer (or are allowed) to use their instrument. You can, however, change the MIDI channel assignments. An obvious candidate for such a change would be the Treble section if you want it to conform to a generally accepted (i.e. standardized) usage, whereby the melody part transmits on MIDI channel 4.

There is indeed a format called "General MIDI" that requires you to use MIDI channel 4 for the melody. General MIDI-compatible musical instruments use that channel for the most important part of a song, so it may be a good idea to assign it to the Treble section.

The table on page 67 states that channel 4 is already used by the (Treble) ORCHESTRA section. That is not really a problem as long as you don't use that section. If you use it alongside the Treble section, changing the Treble's MIDI channel to 4 would mean that both sections transmit on the same MIDI channel. And that would be a problem – or rather one of two problems:

- In Dual mode (page 25), each note you played would be transmitted twice and recorded like that (or played back by the external tone generator).
- In High or Low mode, the "accompaniment" and "solo line" would control the same sound on an external module, which may not correspond to what you had in mind.

In such cases, either assign a different MIDI channel to the ORCHESTRA section – or select "Off" (no transmission).

Note that such changes are only necessary when you want to add the sound of an external tone generator to the Treble section's accordion sound. If you are working with an arranger module or DisCover 5M whose sole function is to provide an accompaniment, you may have to select "Off" for all of the FR-7/FR-5's sections. And even that is only necessary if you use the FBC-7's switches to remotely control the external instrument (page 60) and therefore connected the FBC-7's MIDI OUT socket to the module's MIDI IN port.

Also bear in mind that **the channel assignments set here apply both to the transmission ("TX") and reception ("RX")** of MIDI data.

And finally: in DUAL, HIGH and LOW modes (page 25), the Treble keyboard transmits on two channels simultaneously – the Treble and Orchestra channels. If you add the Orchestra Bass part to the Bass or Free Bass section, the same applies to the bass notes. As stated earlier, the chord buttons of the Bass keyboard use a separate MIDI channel.

- (1) Press and hold the **[EXIT/JUMP]** button until the display looks as follows:



- (2) Press register **[10]** to specify the function group. The MIDI channels can be set via a parameter of the "10. MIDI" group, which is why you need to select that group.
- (3) Press register **[1]** to select the following page:



- (4) Press the **[DATA/ENTER]** knob to select "PART" (left entry), then turn it to select the part whose MIDI channel you want to set. The entries you can select are: "Treble", "Orchestra", "Bass/Free", "Chord", "OrcBass" and "Basic Ch". The "Basic Ch" (default setting "13") can be used for selecting Sets from an external MIDI device (using program change numbers 1~40). If your external source sends Bank Select messages along with the program change number, CC00 and CC32 must both be set to "0".
- (5) Press the **[DATA/ENTER]** knob to select "CHANNEL" (right entry), then turn it to select a MIDI channel. The options are: "Off" and 1~16. Select "Off" if the part in question should neither receive nor transmit MIDI data. Though it is perfectly possible to assign the same MIDI channel to several sections, the result is usually disappointing and may lead to a lot of confusion.
- (6) If necessary, repeat steps (4) and (5) to assign different MIDI channels to the remaining parts.
- (7) Press **[EXIT/JUMP]** to return to the Main page.

The FR-7/FR-5 now asks you whether you want to save your changes:

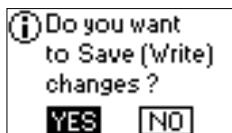

"YES" is selected by default. If you want to save your changes, proceed as described below. (If you don't, turn the **[DATA/ENTER]** knob to select "NO", then press the **[DATA/ENTER]** knob.)

Note: By performing the following steps, you also save other settings you may have changed without saving them. This MIDI parameter indeed belongs to the "Global" group.

- (8) Press the **[DATA/ENTER]** knob. The display now responds with:



- (9) Press the **[WRITE]** button to save your changes. The display briefly shows a confirmation:



Note: If you selected "NO", the edited Global settings will be used until you switch off the FR-7/FR-5 (or change them again).

Preventing sections from sending MIDI data (10.2 Ext. Seq. Playback)

There may be situations where you use a MIDI sequence as accompaniment for your accordion solo. If such a sequence already contains the bass part (for example), you may not want to play it again, yet not doing anything with your left hand may feel a little strange. By selecting "On" for a section, you switch off its connection with the internal tone generator *and* to the FBC-7's MIDI OUT port. The section therefore no longer transmits data (which would allow you to pretend you are playing while you're not). But it now *receives* MIDI data from a sequencer or other instrument you connect to the FBC-7's MIDI IN port.

- (1) Press and hold the **[EXIT/JUMP]** button until the display looks as follows:

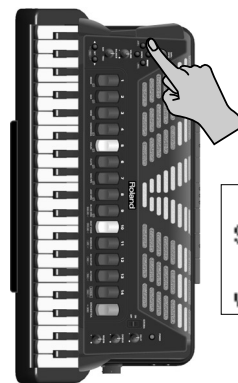

- (2) Press register **[10]** to specify the function group. The "Ext. Seq. Playback" parameters can be set via a parameter of the "10. MIDI" group, which is why you need to select that group.
 (3) Press register **[2]** to select the following page:



- (4) Press the **[DATA/ENTER]** knob to select "PART" (left entry), then turn it to select the part whose setting you want to change. The parts you can select here are: "Treble", "Orchestra" (Treble keyboard) and "Bass-Chord".
 (5) Press the **[DATA/ENTER]** knob to select "VALUE" (right entry), then turn it to select "On" (disconnect the part from the internal tone generator and MIDI OUT socket) or "Off" (normal operation). A part you disconnect from its keyboard and the MIDI OUT socket is flagged as "EXT. MIDI" on the Main page:

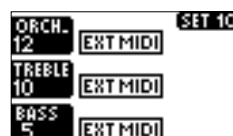

(In this example, all sections are disconnected from the FR-7/FR-5's tone generator, which is probably a highly unlikely configuration.)

- (6) Press **[EXIT/JUMP]** to return to the Main page. The FR-7/FR-5 now asks you whether you want to save your changes:

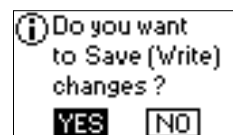

"YES" is selected by default. If you want to save your changes, proceed as described below. (If you don't, turn the **[DATA/ENTER]** knob to select "NO", then press the **[DATA/ENTER]** knob.)

Note: By performing the following steps, you also save other settings you may have changed without saving them. This MIDI parameter indeed belongs to the "Global" group.

- (7) Press the **[DATA/ENTER]** knob. The display now responds with:



- (8) Press the **[WRITE]** button to save your changes. The display briefly shows a confirmation:



Note: If you selected "NO", the edited Global settings will be used until you switch off the FR-7/FR-5 (or change them again).

Solving MIDI buffer problems (10.3 Bellows TX Resolution)

This parameter allows you to specify how many data the FR-7/FR-5's bellows may transmit for expression purposes (see also "Expression" on p. 74). As long as the external sequencer you work with does not display a "MIDI buffer overflow" message, you can leave its setting at "High". If, however, the bellows' data amount is too much for the receiving sequencer (because such data are transmitted on five channels simultaneously), select a different setting. In that case, the amount of data will be reduced. This leads to a coarser resolution, and maybe even audible steps, but at least, your sequencer will be able to record the data. If "Medium" still generates too many data, select "Low".

"TX" means that this parameter only applies to data sent by the FR-7/FR-5. It's own MIDI buffer is big enough to receive high-resolution data.

- (1) Press and hold the **[EXIT/JUMP]** button until the display looks as follows:

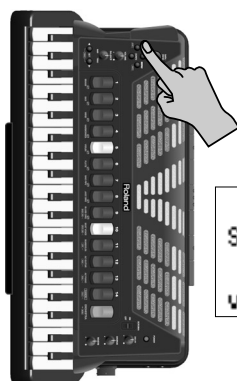

JUMP TO?
Select page MENU
[EXIT/JUMP]
via Treble Register

- (2) Press register **[10]** to specify the function group. The "Ext. Seq. Playback" parameters can be set via a parameter of the "10. MIDI" group, which is why you need to select that group.

- (3) Press register **[3]** to select the following page:



- (4) Rotate the **[DATA/ENTER]** knob to select "High" (high resolution), "Medium", or "Low" (low resolution).
(5) Press **[EXIT/JUMP]** to return to the Main page. The FR-7/FR-5 now asks you whether you want to save your changes:

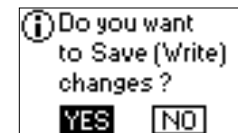

"YES" is selected by default. If you want to save your changes, proceed as described below. (If you don't, turn the **[DATA/ENTER]** knob to select "NO", then press the **[DATA/ENTER]** knob.)

Note: By performing the following steps, you also save other settings you may have changed without saving them. This MIDI parameter indeed belongs to the "Global" group.

- (6) Press the **[DATA/ENTER]** knob. The display now responds with:



- (7) Press the **[WRITE]** button to save your changes. The display briefly shows a confirmation:



Note: If you selected "NO", the edited Global settings will be used until you switch off the FR-7/FR-5 (or change them again).

MIDI parameters for the various sections/parts

The MIDI parameters discussed below belong to separate groups and are saved for the corresponding sections. This means that each Set can use different MIDI settings and thus control external MIDI devices in various ways. If you are serious about using the FR-7/FR-5's MIDI potential, carefully read the following before editing the available parameters.

Important remarks

The parameters discussed below apply to the transmission of MIDI data ("TX") and therefore only to MIDI messages that are generated when you yourself play on the FR-7/FR-5.

Furthermore, these messages are *only transmitted* by sections whose "10.2 Ext. Seq. Playback" parameter is set to "Off" (see above).

Bear in mind that the MIDI messages discussed below are only executed by an external tone generator if its MIDI receive ("RX") channel is set to the number you assigned to the section in question (page 69).

Sections

The parameters discussed here are available in the following sections: Treble, Bass (and Chord, which is considered a separate section on the MIDI level), Free Bass, Orchestra and Orchestra Bass.

The reason why they are included in the section parameters rather than the MIDI group is that the MIDI group applies to the entire FR-7/FR-5 (all sections, all Sets), while the parameters below can vary from Set to Set. If you combine this functionality with the "9.6 Copy SET" function (page 64), you can change the way external MIDI devices are controlled simply by selecting another Set – and still use exactly the same internal sounds: after setting the various section parameters (and saving them), copy the Set to a different memory and only change the MIDI parameters.

Procedure for setting these parameters

To access the parameters discussed below, proceed as follows:

- (1) Select the parameter group of the section you wish to edit.
Either press the **MENU/WRITE** button and select the parameter group with the **DATA/ENTER** knob or use the JUMP TO function (press and hold the **EXIT/JUMP** button, then enter the parameter address using the Treble registers, see p. 35).

- (2) Select the parameter.
(If you used the JUMP TO function above, the parameter is already selected.) Press the **MENU/WRITE** button and select the parameter with the **DATA/ENTER** knob.

The following are MIDI functions:

- 2.14 Treble MIDI TX
- 3.10 Bass MIDI TX
- 3.11 Chord MIDI TX
- 4.10 Free Bass MIDI TX
- 5.7 Orc Bass MIDI TX
- 6.8 Orchestra MIDI TX

- (3) Press the **DATA/ENTER** knob to select "MESSAGE" (left entry), then turn it to select the parameter you want to set.
The parameters are explained below.
- (4) Press the **DATA/ENTER** knob to select "VALUE" (right entry), then turn it to set the desired value. (Press **DATA/ENTER** again, select another parameter and edit its value.)
- (5) Press **EXIT/JUMP** to return to the Main page.
The FR-7/FR-5 now asks you whether you want to save your changes:

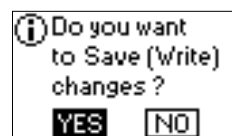

"YES" is selected by default. If you want to save your changes, proceed as described below. (If you don't, turn the **DATA/ENTER** knob to select "NO", then press the **DATA/ENTER** knob.)

- (6) Press the **DATA/ENTER** knob.
- (7) Press the **WRITE** button to save your changes. The display briefly shows a confirmation:



Note: If you selected "NO", your changes will be used until you switch off the FR-7/FR-5, select another Register or change them again.

Parameters

Here are the MIDI parameters that can be set for each register of a section separately. Remember that they only apply to MIDI messages the FR-7/FR-5 sends to external devices. *Do not forget to select the register whose MIDI parameters you wish to edit before actually changing them.*

■ Note

(On, Off, Default setting: On) The MIDI standard translates almost all actions performed on a musical instrument into commands that can be sent to another instrument. The result of such a transmission is that your actions are either recorded by a sequencer or faithfully replicated by the receiving instrument.

The most fundamental information that travels across a MIDI cable is related to the notes you are playing. That information is conveyed using so-called Note-on messages. (Each note has a unique MIDI number.)

Set this parameter to "Off" if the external instrument should not double the notes you are playing on the Treble or Bass keyboard.

■ Octave

(-3~0~3) Here is a parameter that allows you to transpose the Note-on messages transmitted by the section in question (if "Note" is set to "On") up to three octaves up or down.

This can be used for songs where an accordion register of the Treble section (for example) should be doubled by a piccolo flute played by an external module whose notes would be far too low if they were used as is. As stated above, each MIDI note has a unique number. This parameter allows you to add (or subtract) 12 ("1" octave), 24 ("2" octaves) or 36 ("3" octaves) to (from) the note numbers generated by your playing.

Another application for this parameter could be to use the bass notes you play on the FR-7/FR-5 both as (accordion) bass and counter-melody played by a digital piano, for example. In this case, you probably need to transpose the Bass register 3 octaves up.

■ CC00, CC32, PC

(Off, 0~127 for CC00 & CC32; Off, 1~128 for PC) Here are three messages that belong together. The "oldest" message is called "program change" or "PC" for short. It has been around since the inception of the MIDI standard. It is used to select sounds or memories on the receiving instrument simply by recalling another sound (or memory) on the transmitting instrument.

What you set here is transmitted to the FBC-7's MIDI OUT port whenever you select the register you are currently editing. (You can set separate addresses for each register.) This allows you to cause an external module to select the sounds that match the accordion, etc., sounds you defined.

Select "Off" if a register should not send CC00, CC32 and/or PC messages.

Why are there three messages? When the MIDI standard was developed, some 20 years ago, 128 memories seemed a lot, which is why it was decided to use a dedicated message type (program change) for selecting memories on an external device.

The entire MIDI standard evolves around the magic number "128". Given that there is no way of expanding that number, so-called Bank Select messages were later added to accommodate the growing number of memories (modules with more than 2,000 sounds are quite common these days).

At the time, neither CC00, nor CC32 had dedicated functions and so these two control change messages were picked for bank selection.

Two bank addresses ("MSB" and "LSB") with 128 possibilities each, plus 128 Program Change numbers provide 128 x 128 x 128 values= 2,097,152 possible memories.

Transmitting only Bank Select messages does nothing at all, while working only with program change messages means that you are limited to the 128 memories of the currently active memory bank.

To switch banks and select a memory on the external module you need to transmit:

- A value for control change CC00 (MSB)
- A value for control number CC32 (LSB)
- A program change number

See the manual of the receiving MIDI instrument for the MSB and LSB values it supports.

Be aware that this system allows you to send program change numbers to an external instrument that lie outside the range of the FR-7/FR-5's registers (1~14 for Treble, 1~7 for Bass/Free Bass/Orch. Bass, 1~22 for Orchestra). Such "excess" program numbers are ignored by the FR-7/FR-5 when you transmit them back (from a sequencer, for example). Example: if you select PC= 49 and transmit that value to a sequencer (to select a strings sound on an external module, for instance), the external module behaves as you expect when the sequencer track transmits that value. If you then decide to use the FR-7/FR-5's ORCHESTRA section for your string part, that section will not switch sounds (because it only recognizes program numbers 1~22).

Note: If PC is set to "Off", the CC00 and CC32 values are not transmitted (CC00/CC32 must always be followed by a program change number).

■ Volume

(Off, 0~127, Default: 100) This parameter allows you to specify the volume value (CC07) to be transmitted by the register whenever you select it while playing. That way, the MIDI instrument you are controlling is automatically set to the desired level. Remember that selecting "0" silences the receiving MIDI instrument. Select "Off" if the register should not transmit this message. Note that the FR-7/FR-5 does not execute this message if it is returned to the FR-7/FR-5 via the external device's "Soft Thru" function.

■ Panpot

(Off, 0~127, Default: 64) This parameter allows you to specify the Pan value (CC10) to be transmitted by the register whenever you select it while playing. That way, the MIDI instrument you are controlling automatically selects the desired stereo position. "0" correspond to hard left, "64" to dead center, and "127" to hard right. Note that the FR-7/FR-5 does not execute this message if it is returned to the FR-7/FR-5 via the external device's "Soft Thru" function. Select "Off" if the register should not transmit this message.

■ Reverb

(Off, 0~127, Default: 40) This parameter allows you to specify the Reverb Send Level value (CC91) to be transmitted by the register part whenever you select it. Selecting "0" will set the receiving MIDI instrument

to "dry" (no Reverb), while "127" represents the maximum Reverb Send level. Select "Off" if the register should not transmit this message.

Note: If there is no audible change, you may have to check the Reverb effect settings on the receiving MIDI instrument.

Note: Not all MIDI instruments have a reverb effect and even if they do, they may not support this control change number (this is especially true of older instruments).

■ Chorus

(Off, 0~127, Default: 0) This parameter allows you to specify the Chorus Send Level value (CC93) to be transmitted by the register whenever you select it. "0" will set the receiving MIDI instrument to "dry" (no Chorus), while "127" represents the maximum Chorus Send level. Select "Off" if the register should not transmit this message.

Note: If there is no audible change, you may have to check the Chorus effect settings on the receiving MIDI instrument.

Note: Not all MIDI instruments have a chorus effect and even if they do, they may not support this control change number (this is especially true of older instruments).

■ Velocity

(On, 1~127) Your FR-7/FR-5 is velocity sensitive. That is a very learned term for the fact that the volume and brightness of the notes you play on the Treble or button keyboard depend on how hard (or fast) you press the keys/buttons. The accordion sounds do not respond to these playing dynamics, but the Orchestra (Treble and Bass) sounds do and so do most MIDI-compatible sound modules.

Even though the MIDI standard recognizes 128 different velocity values, only 127 can actually be used for expression purposes. That explains why the setting range is 1~127. Value "0" is usually used to signal the end of a note (i.e. when you release a key or button).

This parameter allows you to specify whether the velocity values corresponding to the strength with which you press a key/button should be transmitted ("On") or whether your playing dynamics should not be translated as such. In the latter case, you need to select a value (1~127) that will be applied to all notes that are transmitted via MIDI. "64" is still relatively soft, so even lower values are probably not what you want in most cases. Fixed velocity values can be useful for playing organ sounds on an external module.

Note that the setting you select here has no effect when the "Note" parameter is set to "Off", because note numbers are always transmitted along with a velocity value (any value different from "0" also means "start playing this note"). Sending only a velocity value without specifying the note to which it applies doesn't make sense.

■ Expression

(Off, Bellows, Pedal) You probably know that the strength/speed with which the bellows is pressed or pulled influences the sound – which corresponds to an acoustic accordion's response.

This effect can be translated into a MIDI message most external instruments understand. The MIDI standard provides a message ("control change") for remotely controlling the volume of an external instrument: CC11. It is chiefly used for expression purposes (similar to the way in which a guitarist or organ player uses a volume pedal).

If you want to use the bellows for expressive purposes, set this parameter to "Bellows".

If you don't (because the external instrument is too sensitive and therefore changes its volume too often), select "Off".

If you purchased an optional EV-5 expression pedal, which you connected to the FBC-7's EXPRESSION PEDAL socket, you can also control the relative volume by foot. In that case, set this parameter to "Pedal".

■ AfterT (only for the Treble and Orchestra sections)

The Treble keyboard also generates aftertouch messages. Aftertouch is usually used for temporary changes to a sound's volume, timbre or pitch (this needs to be set on the receiving instrument). Used right, it can be a very powerful expressive tool.

The downside is, however, that aftertouch messages usually represent a massive amount of data, which makes it a lot harder to find the MIDI messages you want to edit on an external sequencer, not to mention the fact that your song files become a lot heavier than they need to be.

Besides, many sounds/parts on external MIDI instruments are set to ignore these messages by default, so that you would end up sending a lot of information for nothing. That is why we recommend setting this parameter to "Off" and only select "On" if you really mean to take advantage of the Treble keyboard's aftertouch capability.



Archiving your settings via MIDI (Bulk Dump)

MIDI can also be used for transmitting parameter and memory settings from the FR-7/FR-5 to an external MIDI device and back.

Archiving your settings with a sequencer

The Bulk Dump parameters allow you to transmit the contents of one or all Set memories to a second FR-7 or FR-5, an external sequencer, computer or data filer. Sending these data to other instruments (a digital piano, synthesizer, etc.) does nothing at all. That's because the setting data are special MIDI messages only one model (or model family) understands. They are called "system exclusive messages" – or "SysEx" for short. By transmitting them to a second FR-7/FR-5, however, you can "copy" the settings of your V-Accordion to that of a friend, colleague or student.

Even a sequencer or data filer does not know what the messages mean and so does not use them in any way. It merely records them. Afterwards, you only need to start playback on your sequencer or data filer to transmit the settings back to the FR-7/FR-5.

- (1) Connect the FBC-7's MIDI OUT socket to the sequencer's/computer's MIDI IN socket.
See page 66 for a connection diagram. Obviously, you also need to connect the FR-7/FR-5 to the FBC-7.
Note: Your computer needs to be equipped with (or connected to) an appropriate MIDI interface.
- (2) If you are working with a computer, launch the sequencer program.
- (3) Create or select an empty song.
- (4) Create (or select) an empty track.
The track's MIDI channel is of no importance here. You need to ensure, however, that the sequencer/program accepts SysEx data. If necessary, switch off the MIDI filter in question (see the manual of your sequencer or software).
- (5) Switch off the sequencer's MIDI Echo (or Soft Thru) function.
If that's too tedious, disconnect the MIDI cable from the sequencer's/computer's MIDI OUT socket. This is to ensure that the sequencer doesn't transmit the SysEx data back to the FR-7/FR-5 right away, which might cause problems.
- (6) Activate the record-ready mode of the track you selected/created.
Note: It would be wise not to change the tempo on your sequencer/in the software. By default, most sequencers/programs use the tempo value ♩ = 120. Leave it that way (or else do whatever is necessary to ensure that the new tempo value is stored along with the data).
- (7) If you want to archive the settings of just one Set (9.8 Bulk Dump SET), select it on the FR-7/FR-5 using the SET   buttons.

- (8) On the FR-7/FR-5, press and hold the **EXIT/JUMP** button, then press register **9**.

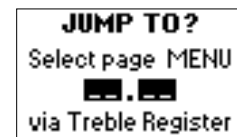

Depending on whether you want to archive all Sets or just the settings of one Set, either press register **7** (9.7 Bulk Dump ALL) or **8** (9.8 Bulk Dump SET). The display now responds with:

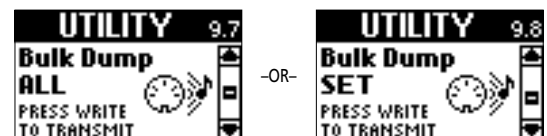

Before going on tour, etc., select "ALL" to make a backup copy of your Sets. Select "SET" to transmit only the settings that are actually needed for the song in question. This transmits the settings of the Set you are currently using.

- (9) Start recording on your sequencer/computer. Wait until the count-in (one or two measures) is finished, then...
- (10) Press **MENU/WRITE** on the FR-7/FR-5 to start the transmission of the bulk data.
The display now responds with:

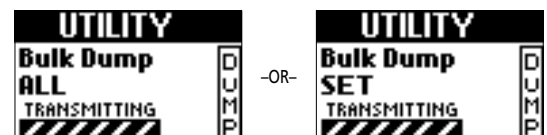

Press **EXIT/JUMP** if you do not want to transmit your settings after all.

- (11) Wait until the following message appears, then stop recording on your sequencer.



- (12) Name the "song" (it may only contain data so far) and save it to hard or floppy disk.
To transmit the settings back to the FR-7/FR-5 at a later stage, see below.

Sending Bulk data (back) to the FR-7/FR-5

The FR-7/FR-5 not only sends SysEx data to external devices (see above), it also receives them. In fact, the FR-7/FR-5 accepts several kinds of Bulk data:

- Entire Sets that overwrite the contents of all internal Set memories. If you don't want to lose the settings that currently reside in the FR-7/FR-5's internal memories, archive them first using the procedure described on page 75.
- One Set: in this case, you can choose where to save the received Set data.

- (1) Connect the FBC-7's MIDI IN socket to the sequencer's/computer's MIDI OUT socket. See page 66 for a connection diagram. Obviously, you also need to connect the FR-7/FR-5 to the FBC-7.

Note: Your computer needs to be equipped with (or connected to) an appropriate MIDI interface.

- (2) If you are working with a computer, launch the sequencer program.
- (3) Load the song that contains the data you want to transmit.
- (4) On your sequencer, perform all necessary actions to ensure that it transmits SysEx data. See its manual for details.

Note: If you are about to transmit a group of 40 Sets ("ALL") to the FR-7/FR-5, ask yourself whether you have archived the Set data that currently reside in the internal memories or whether it is OK to overwrite them. Be aware that by proceeding with an "ALL DATA" file, you replace all internal settings.

- (5) Start playback of the data file or song on your sequencer, etc.

The display now responds with:

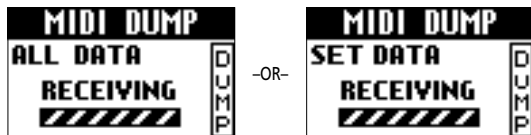

Note: When transmitting an "ALL DATA" file to the FR-7/FR-5, wait until the "WRITE COMPLETE" message appears before stopping playback on your sequencer. Failure to do so will render your FR-7/FR-5 inoperable. If that happens, you need to initialize it (see "Restoring the factory defaults" on p. 78).

- (6) Stop playback of your sequencer. If you transmitted one Set to the FR-7/FR-5, the display now responds with:

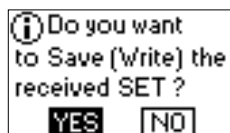

This message means that the corresponding data currently reside in the FR-7/FR-5's temporary memory but that you need to save them if the FR-7/FR-5 should remember them. A Set received in this way can be used until you select another (internal) Set. If you think you'll need the Set at a later stage, be sure to save it. If you only need it temporarily, you can select "NO". The FR-7/FR-5 will then use the

sound (and MIDI) settings received from the computer, but they will be "forgotten" when you switch the FR-7/FR-5 off or select another Set.

"YES" is selected by default. If you want to save your changes, proceed as described below. (If you don't, turn the **DATA/ENTER** knob to select "NO", then press the **DATA/ENTER** knob.)

To save the Set data:

- (7) Press the **DATA/ENTER** knob. The display now responds with:

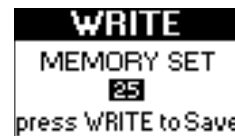

- (8) Rotate the **DATA/ENTER** knob to select the target memory for the received Set (1~40). Be aware that the data in the memory you select here will be overwritten.
- (9) Press the **WRITE** button to save your changes. The display briefly shows a confirmation:



In some cases, the display may show the following message. It means that the SysEx data were incomplete or that the checksum was missing or wrong.



Press **EXIT/JUMP** to return to the Main page, reduce the speed at which the data are transmitted by your sequencer, and try again. If that does not help, check the data file you are transmitting.

8. Miscellaneous functions

Saving settings using the WRITE function

While editing the MENU functions, you are usually asked whether you want to save the changes you have just made. You may remember that you also have the option ("NO") to ignore that message, which may be useful if you are not sure yet whether the new version is actually better than the previous one.

Important remarks

- The WRITE function on the display page shown below **only applies to the registers that you are currently using**. If you decided not to save the settings of the last Treble register you edited (for example), do not select another Treble register until you have made up your mind. Otherwise, your changes are lost (in which case the "Treble" field on the "WRITE" page shown below no longer has an "E" flag). In other words: you cannot edit register [1], not save it, then edit register [2], not save it, etc. In this example, the changes made to register [1] are lost as soon as you select register [2] (i.e. even before actually start editing it). The same applies to the Bass, Free Bass, Orchestra and Orchestra Bass sections.
- Bear in mind that Bass/Free Bass/Orchestra/Orchestra Bass registers are selected automatically when the Link function is on (page 42). Such a switch also erases changes to the previously selected registers if you decided not to save them when the FR-7/FR-5 suggested doing so.
- The Bass and Free Bass sections cannot be used simultaneously. Switching to the other mode before saving the changes you may have made for the register of the previous mode (Bass or Free Bass) also leads to those changes being lost.

Using WRITE

- (1) Press and hold the **[MENU/WRITE]** button until the following page appears:

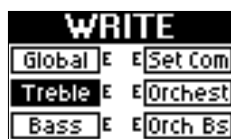

On this page, sections whose settings you changed without saving them are flagged with an "E" (for "edited"). The "E" flag only applies to the currently selected register (Treble, Bass/Free Bass, Orchestra or Orchestra Bass).

The section whose MENU parameter you changed last before selecting this page is already selected. In the above example, all sections have changed, while the last parameter you edited belongs to the TREBLE group.

Note: If there are no "E" flags, there is nothing that needs to be saved. Consequently, you can leave this page by pressing **[EXIT/JUMP]** again.

Note: To save the Global settings, skip to step (7), for the Orchestra, Orchestra Bass and Set Common parameters, skip to step (6).

- (2) Rotate the **[DATA/ENTER]** knob to select the section whose settings you want to save.

The possibilities are:

- Global—The 1. Tuning, 8. System and 10. MIDI settings.
- Treble—The settings of the selected Treble register, i.e. the 2. Treble Edit group.
- Bass—The 3. Bass Edit or 4. Free Bass Edit settings.
- Set Com—The 7. Set Common settings.
- Orchest—The 6. Orchestra Edit settings.
- Orch Bs—The 5. ORC Bass Edit settings.

- (3) Press the **[DATA/ENTER]** knob to jump to a page where you can name your settings.

This functionality is only available for the following parameter groups: 2. Treble Edit, 3. Bass Edit and 4. Free Bass Edit. (See "7.7 Name" on p. 59 for how to name a Set.)



(*) Only one of these pages can be displayed. This depends on whether you are currently in Bass or Free Bass mode.

- (4) If necessary, change the name of the register you have just edited. (This is only possible on the three pages shown above.)

See "Entering names" on p. 40 for details.

- (5) Press the **MENU/WRITE** button to jump to one of the following pages (not available when you are saving the Global settings):



- (6) If necessary, select another Set and/or another register than the ones you are currently using. (You can only select a different Set for the Orchestra, Orchestra Bass and Set Common settings.)

Press the **DATA/ENTER** knob to select "SET" or "REGISTER", then turn it to select the number ("1~40" for SET, "1~14" for REGISTER).

- (7) Press the **MENU/WRITE** button to save your changes.



Note: Never switch off the FR-7/FR-5 while the above message is displayed to avoid scrambling the internal memory. See also "At power-on, the FR-7/FR-5 displays the following message" on p. 80 for what to do in such a case.

The display now briefly confirms that your settings have been stored:



The display returns to the Main page.

- (8) Proceed with step (1) above.

Restoring the factory defaults

You can reset the FR-7/FR-5 to its factory settings, which means that your own Sets and Global settings are replaced by the settings the FR-7/FR-5 contained when you first got it. You may wish to archive your settings before initializing the FR-7/FR-5 (see p. 75).

- (1) Switch on the FR-7/FR-5 while holding down the **MENU/WRITE** button. The display changes to:



- (2) Press the **DATA/ENTER** knob to initialize the FR-7/FR-5 ("YES" is selected by default). If you decide against initializing the FR-7/FR-5, rotate the **DATA/ENTER** knob to select "NO", then press it.

If you selected "YES" and pressed the **DATA/ENTER** knob, the display now briefly confirms that your V-Accordion has been initialized:



The FR-7/FR-5 now sounds and behaves like when you first bought it.

Troubleshooting

This section provides an overview of points to check and actions to take when the FR-7/FR-5 does not function as you expect. Feel free to contact your Roland dealer if your issue remains unsolved after reading through this section.

The screen is difficult or impossible to read

If you have trouble reading the information in the display, change the "8.1 LCD Contrast" setting (page 60).

No sound

■ Did you turn the **VOLUME** knob all the way to the small dot?

Set it to a higher value.

■ Did you turn the **BALANCE** knob all the way to one side?

Change its setting and try again.

■ Are you moving the bellows while triggering accordion sounds?

The Treble and Bass/Free Bass sections only produce sound if you move the bellows while playing notes (like on an acoustic accordion).

■ Did you connect the FR-5 to an external amplifier?

The FR-5 doesn't contain internal speakers and therefore needs to be connected to an external amplification system. Alternatively, you can use a pair of headphones.

■ Did you connect the audio cables to the correct sockets?

If so, check whether the external amplifier, mixing console, etc., is switched on. Also check the cables for possible damage.

No power

■ Did you remove the supplied (FR-7) battery?

Be sure to install it again. Alternatively, connect the FR-7 to the supplied FBC-7.

■ Did you install the cover of the FR-7/FR-5's battery compartment?

You need to install it before you can switch on the FR-7/FR-5 (page 34). Be sure to tighten the screws all the way.

■ Did you connect the FR-5 to the FBC-7?

If you did not purchase an optional battery, the FR-5 needs to be powered by the FBC-7.

The FR-7/FR-5 does not respond to your playing

■ You may have selected "Ext. Seq. Playback" mode for one or all sections.

Those sections therefore only respond to MIDI messages received from other instruments. Switch off the "Ext. Seq. Playback" function (page 70).

■ Are you moving the bellows while triggering accordion sounds?

The Treble and Bass/Free Bass sections only produce sound if you move the bellows while playing notes (like on an acoustic accordion).

Certain parameters cannot be selected

■ Is the FR-7/FR-5 currently in "Easy" mode?

In that mode, only a basic set of parameters is available. Switch to "Full" mode (page 18).

■ Does the FR-7/FR-5 display a message to inform you that a parameter or section is not available?

If so, the section is off, which is why its parameters cannot be edited. Switch the section on and try again.

One section sounds off (flat)

Did you set "1.5 Scale Assign" to just one section? Set it to "ALL" and try again (page 39).

Issues related to the bass buttons

■ Why do the bass buttons only provide three chord rows?

Because you set the "8.5 Bass & Chord Mode" parameter to "3 Bass Rows" (page 61). Set it to "2 Bass Rows".

■ Why can't I play diminished chords using the bass buttons?

Because you set the "8.5 Bass & Chord Mode" parameter to "3 Bass Rows" (page 61). Set it to "2 Bass Rows".

■ In Free Bass mode, the bass buttons play the wrong notes.

You may have changed the "8.6 Free Bass Mode" setting. Be sure to select the system that best suits your playing style (page 62).

■ In Free Bass mode, only half the buttons play notes.

That's because the "STATUS" entry of the "4.2 Register" parameter uses the same ("High" or "Low") setting for both reeds (or "Off" for one of them and "High"/"Low" for the other). Choose complementary settings ("High" for one, "Low" for the other) or set at least one to "Whole" (page 49).

Why does the Orchestra mode change when I press a given Treble register?

Because you established a Link with the Treble section and also specified a mode using the "MODE" entry of the "2.13 Orchestra Link" parameter. Set it to "---" (page 43).

My settings have changed

■ Did you ignore the message that suggested writing your settings?

If so, you probably switched to a different mode (e.g. Free Bass instead of Bass) or another register. The changes you made before doing so have been erased. You can only edit one register at a time. If you select another register before saving the changes for the previously selected register (by selecting "NO"), those

changes are erased. Similarly, do not switch off the FR-7/FR-5 or select another Set before saving settings you want to keep: save them first.

■ **Did you establish a "Link"?**

If you change the Bass, Free Bass, and/or Orchestra settings without saving them, and then select another Treble register while the Link function is on, the FR-7/FR-5 selects different settings for the linked sections. Your changes are therefore lost.

■ **Did you save the "SET COMMON" parameters?**

Doing so only saves the general Set parameters, not the settings of the various registers.

■ **Did a "Noise" setting change?**

Whenever you select "ALL" for "2.1 Reed Type", and set a different reed type, the "2.5 Valve Noise" setting is automatically adapted to that reed type. You may have to change it afterwards if you wish to use a different noise type.

Whenever you select "ALL" for "3.1 Reed Type" and set a different reed type, the "3.5 Reed Growl" setting is automatically adapted to that reed type. It would therefore be a good idea to first select the reed type and only then change the growl type. The same applies to "4.4 Button Noise" and "4.1 Reed Type".

■ **Did the effects parameters change unexpectedly?**

Each effects processor (Reverb, Chorus, Delay) has a "Macro" parameter (pages 56 and 58) that not only recalls a different effect type, but also appropriate settings for that type. If you select another Macro, the settings for the previous effect type are lost.

MIDI-related issues

■ **I selected the "Ext. Seq. Playback" mode, yet the section in question does not respond to MIDI messages.**

Does the section's MIDI channel correspond to the transmit channel of the external device (page 69)? Do not select "Off" for a section that should receive MIDI messages.

■ **What MIDI channels does the FR-7/FR-5 use by default?**

See the table on page 67.

■ **The MIDI channel setting is correct, yet the section in question does not transmit notes.**

You probably set its "Note" parameter to "Off" (page 72).

■ **The FR-7/FR-5 does not change sounds when my sequencer transmits program change numbers, even though I used the FR-7/FR-5 to send those numbers to the sequencer.**

You can send program change numbers to an external instrument that lie outside the range of the FR-7/FR-5's registers (1~14 for Treble, 1~7 for Bass/Free Bass/Orch. Bass, 1~22 for Orchestra). Such "excess" program numbers are ignored by the FR-7/FR-5 when you transmit them back (from a sequencer, for example).

■ **I cannot find the MIDI sockets on my FR-7/FR-5.**

The FR-7/FR-5 does not have MIDI sockets. You need to connect it to the FBC-7 using the supplied 19-pin cable (page 66).

■ **The FR-7/FR-5 does not receive the MIDI messages I recorded for it.**

That's because the "Ext. Seq. Playback" parameter of the sections in question is set to "Off". You need to activate it if you wish to use the FR-7/FR-5 as MIDI tone generator (page 70).

■ **All the FR-7/FR-5's settings have changed.**

You probably transmitted a "Bulk" file containing 40 Sets ("ALL") to the FR-7/FR-5. The settings of that file have replaced your own settings. We regret that your settings cannot be restored. Be sure to archive the internal settings before transmitting bulk data to the FR-7/FR-5 (page 75).

■ **The external sequencer keeps displaying a "MIDI buffer overflow" message**

The bellows sends too many data at once (its data are transmitted on five channels simultaneously). Select a different setting ("Medium" or "Low"). This leads to a coarser resolution, and maybe to audible steps, but at least, your sequencer will be able to record the data. See "Solving MIDI buffer problems" on p. 71.

While saving data, the FR-7/FR-5 displays the following message



It means that the data could not be saved in the FR-7/FR-5's internal memory. Press [\[EXIT/JUMP\]](#) to leave this page. **WARNING:** this will take you to the Main page. **Do not** select other registers or Sets. First try to save your settings using the WRITE function (page 77). If the above message appears again, contact your Roland dealer to have your FR-7/FR-5's memory checked.

At power-on, the FR-7/FR-5 displays the following message



The FR-7/FR-5 was switched off while it was saving data (possibly because the battery was depleted, or because of a power failure). When you switch it on again, it attempts to recover everything it can. It may, however, also load the data of the corresponding factory set. In any case, you will have to program some or all settings again.

Specifications

■ Keyboards

Right hand: 41 keys, piano-type with velocity and after-touch

Left hand: 120 velocity-sensitive bass buttons,
Modes: Standard, Free Bass, Orch.Bass

■ Bellows

Real pneumatic detection of bellows pressure (high-resolution pressure sensor)

■ Sound source

Max polyphony: 128 voices

Wave ROM: 32MB of waveforms

Tones: 40 user programmable accordion Sets, each one including: 14 Treble registers, 7 Bass registers, 7 Free Bass registers, 7 Orchestra Bass registers, 22 Orchestral sounds

Treble reed footages: 7

Bass reed footages: 5

Chord reed footages: 3

Free Bass footages: 2

■ PBM (Physical Behavior Modeling)

Noises: stopping-reed growl, closing valve noise, left button noise

Individual reed simulation: hysteresis threshold, Expression curve, pressure-variant filter, pressure-variant pitch deviation

Reed sound wave switching: by bellows acceleration, by note repetition speed

■ Musette tuning

Micro tuning presets: 16 (Off, Dry, Classic, F-Folk, American L/H, North Europe, German L/H, D-Folk L/H, Alpine, Italian L/H, French, Scottish)

■ Effects

Reverb: 8 types, Chorus: 8 types,

Delay: 10 types, Rotary for Orchestra organ sounds (slow/fast)

"Cassotto" and "Sordina" simulation

■ Panel controls

Knobs: Volume, Treble/Bass balance, Reverb, Chorus, Delay,
Encoder: DATA/ENTER

Panel Switches: 14 Treble registers + Master + Orchestra,
7 Bass registers

Navigation switches: UP/DOWN, MENU/WRITE, EXIT/JUMP

Other switches: SET UP/DOWN, SORDINA ON/OFF, POWER

■ Display

48 x 84 graphic, backlit LCD

■ Rated power output (FR-7)

2 x 25W RMS

■ Speakers (FR-7)

2 x 10cm speakers (neodymium transducer magnets), 2 tweeters

■ Others

Connectors on instrument: HEADPHONE socket (stereo), OUTPUT sockets (stereo), multi-connector (towards external FBC-7 power supply/footswitch unit/battery charger)

Power Supply: rechargeable Ni-Mh battery pack (24V-4500mAh) (optional for FR-5)

External FBC-7 power supply/battery charger: AC 117 V, AC 230 V, AC 240 V (50/60 Hz), AC 220 V (60 Hz)

Power consumption: 96W

Dimensions (mm): 423 (H) x 528 (W) x 275 (D) mm

Weight: FR-7: 11.7kg, FR-5: 9.5kg

■ Supplied accessories

External FBC-7 power supply/battery charger: 5 programmable foot switches (SET UP/DOWN, REGISTER UP/DOWN, SUSTAIN), multi-core connector cable (towards accordion), expression pedal socket, MIDI IN/OUT/THRU sockets, OUTPUT sockets (L/Mono, R), connector for charging a battery, AC inlet

Owner's Manual

Power cable

Reference caps for the bass buttons

19-pin multicore cable

Accordion cloth

Straps

Battery (FR-7)

■ Options

Accordion soft bag

Battery (for FR-5, spare part for FR-7)

Pedal Board Soft Bag

Parameter list

VOLUME AND EFFECT		
BALANCE		The default value corresponds to the current physical position of potentiometer. The central position is 0. The values range from 0 to 64 regardless of whether the arrow symbol indicates BASS or TREBLE.
REVERB		The default value corresponds to the current physical position of potentiometer. Range: 0~127
CHORUS		The default value corresponds to the current physical position of potentiometer. Range: 0~127
DELAY		The default value corresponds to the current physical position of potentiometer. Range: 0~127
FULL MODE MENU (all parameters)		
1. TUNING		
1.1 Master Tune*	Value	415.3Hz~440.0Hz~466.2Hz
1.2 Transpose	Value	F# -6, G -5, Ab -4, A -3, Bb -2, B -1, C 0, C#1, D2, Eb3, E4, F5
1.3 Scale*	Type	Equal (Off), User 1, User 2, User 3, Arabic1, Arabic2, Just Major, Just Minor, Pythagorean, Mean-Tone, Werckmeister, Kirnberger
	Key	C, C#, D, Eb, E, F, F#, G, Ab, A, Bb, B
1.4 Scale Edit*	Type	User 1, User 2, User 3
	Tune Note	C, C#, D, Eb, E, F, F#, G, Ab, A, Bb, B
	Tune Value	-64~0~63 for each note
1.5 Scale Assign*	Part	Treble, Orchestra, Treb&Orch, Bass&Chord, ALL
2. TREBLE EDIT		
2.1 Reed Type	Foot	ALL, 16', 8', 8'-, 8'+, 4', 5-1/3', 2-2/3'
	Type	Bandoneon, I-Folk, I-Folk2, Classic, Cajun, Jazz, F-Folk, D-Folk, Organetto, F-Folk2, Classic2, Studio, Tradition, Steierische, OldItaly, TexMex, Trikitixa
2.2 Register	Foot	16', 8', 8'-, 8'+, 4', 5-1/3', 2-2/3'
	Status	Off, On, On-Cassotto
2.3 Reed Volume	Value	16', 8', 8'-, 8'+, 4', 5-1/3', 2-2/3'
	Level	Off, -30~Std~30
2.4 Treble Octave	Value	-1, 0, 1
2.5 Valve Noise	Type	Bandoneon, I-Folk, I-Folk2, Classic, Cajun, Jazz, F-Folk, D-Folk, Organetto, F-Folk2, Classic2, Studio, Tradition, Steierische, OldItaly, TexMex, Trikitixa
	Level	Off, -30~Std~30
2.6 Musette Detune	Type	Off, Dry, Classic, F-Folk, American_L, American_H, North_Eur, German_L, D-Folk_L, Italian_L, German_H, Alpine, Italian_H, D-Folk_H, French, Scottish
2.7 Bellows Detune	Type	Off, Low, Standard, High
2.8 Reverb Send	Level	0~127
2.9 Chorus Send	Level	0~127
2.10 Delay Send	Level	0~127
2.11 Aftertouch Pitch	Mode	Off, 1/4 Down, 1/2 Down, 1/4 Up, 1/2 Up Pitch
2.12 Bass Link	Bass	No Link, Bass 1~Bass 7, Free 1~Free 7
	Orc.Bass	No Link, Acoustic, Bowed, Fingered, Fretless, Picked, Tuba, TubaMix
2.13 Orchestra Link	Register	No Link, 1A Trombone, 1B Trumpet, 2A TenorSax, 2B AltoSax, 3A Clarinet, 3B Oboe, 4A Harmonica, 4B MuteHarm, 5A Violin, 5B Pizzicato, 6A Flute, 6B PanFlute, 7A HighLand, 7B Zampogna, 8A PercOrgan, 8B JazzOrgan, 9A RotOrgan, 9B TremOrg, 10 ScatVoice, 11 Mandolin, 12AcGuitar, 13 AcPiano
	Mode	----, Solo, Dual, Low, High
2.14 Treble MIDI TX	Message & value	Note [On,Off], Octave [-3~0~3], CC 00 [Off, 0~127], CC 32 [Off, 0~127], PC [Off, 1~128], Volume [Off, 0~127], Panpot [Off, 0~127], Reverb [Off, 0~127], Chorus [Off, 0~127], Velocity [On, 1~127], Express [Off, Bellows, Pedal], AfterT. [On,Off]
3. BASS EDIT		
3.1 Reed Type	Foot	ALL, 16', 8', 8'-4', 4', 2'
	Type	Bandoneon, I-Folk, I-Folk2, Classic, Cajun, Jazz, F-Folk, D-Folk, Organetto, F-Folk2, Classic2, Studio, Tradition, Steierische, Trikitixa

3.2 Register	Foot	16', 8', 8'-4', 4', 2'
	Status	Off, Bass, Chord, Bass&Chord <i>Note:</i> With the 16' and 8' feet selected the "Status" can only be either "Off" or "Bass". With the 8'-4', 4' and 2' feet selected the "Status" can only be "Off", "Chord" or "Bass&Chord".
3.3 Reed Volume	Value	16', 8', 8'-4', 4', 2'
	Level	Off, -30~Std~30
3.4 Button Noise	Type	Bandoneon, I-Folk, I-Folk2, Classic, Cajun, Jazz, F-Folk, D-Folk, Organetto, F-Folk2, Classic2, Studio, Tradition, Steierische, Trikitixa
	Level	Off, -30~Std~30
3.5 Reed Growl	Type	Bandoneon, I-Folk, I-Folk2, Classic, Cajun, Jazz, F-Folk, D-Folk, Organetto, F-Folk2, Classic2, Studio, Tradition, Steierische, Trikitixa
	Level	Off, -30~Std~30
3.6 Bellows Detune	Type	Off, Low, Standard, High
3.7 Reverb Send	Level	0~127
3.8 Chorus Send	Level	0~127
3.9 Delay Send	Level	0~127
3.10 Bass MIDI TX	Message & value	Note [On,Off], Octave [-3~0~3], CC 00 [Off, 0~127], CC 32 [Off, 0~127], PC [Off, 1~128], Volume [Off, 0~127], Panpot [Off, 0~127], Reverb [Off, 0~127], Chorus [Off, 0~127], Velocity [On, 1~127], Express [Off, Bellows, Pedal]
3.11 Chord MIDI TX	Message & value	Note [On,Off], Octave [-3~0~3], CC 00 [Off, 0~127], CC 32 [Off, 0~127], PC [Off, 1~128], Volume [Off, 0~127], Panpot [Off, 0~127], Reverb [Off, 0~127], Chorus [Off, 0~127], Velocity [On, 1~127], Express [Off, Bellows, Pedal]
4. FREE BASS EDIT		
4.1 Reed Type	Foot	ALL, 16', 8'
	Type	Bandoneon, I-Folk, I-Folk2, Classic, Cajun, Jazz, F-Folk, D-Folk, Organetto, F-Folk2, Classic2, Studio, Tradition, Steierische, Trikitixa
4.2 Register	Foot	16', 8'
	Status	Off, Low, High, Whole
4.3 Reed Volume	Foot	16', 8'
	Level	Off, -30~"Std"~30
4.4 Button Noise	Type	Bandoneon, I-Folk, I-Folk2, Classic, Cajun, Jazz, F-Folk, D-Folk, Organetto, F-Folk2, Classic2, Studio, Tradition, Steierische, Trikitixa
	Level	Off, -30~Std~30
4.5 Reed Growl	Type	Bandoneon, I-Folk, I-Folk2, Classic, Cajun, Jazz, F-Folk, D-Folk, Organetto, F-Folk2, Classic2, Studio, Tradition, Steierische, Trikitixa
	Level	Off, -30~Std~30
4.6 Bellows Detune	Type	Off, Low, Standard, High
4.7 Reverb Send	Level	0~127
4.8 Chorus Send	Level	0~127
4.9 Delay Send	Level	0~127
4.10 Free Bass MIDI TX	Message & value	Note [On,Off], Octave [-3~0~3], CC 00 [Off, 0~127], CC 32 [Off, 0~127], PC [Off, 1~128], Volume [Off, 0~127], Panpot [Off, 0~127], Reverb [Off, 0~127], Chorus [Off, 0~127], Velocity [On, 1~127], Express [Off, Bellows, Pedal]
5. ORC BASS EDIT		
5.1 Lowest Note	Lowest Note	E=28, F=29, F#=30, G=31, Ab=32, A=33, Bb=34, B=35, C=36
5.2 Orc Bass Release Time	Release Time	0~63
5.3 Orc Bass Volume	Level	Off, -30~Std~30
5.4 Reverb Send	Level	0~127
5.5 Chorus Send	Level	0~127
5.6 Delay Send	Level	0~127
5.7 Orc Bass MIDI TX	Message & value	Note [On,Off], Octave [-3~0~3], CC 00 [Off, 0~127], CC 32 [Off, 0~127], PC [Off, 1~128], Volume [Off, 0~127], Panpot [Off, 0~127], Reverb [Off, 0~127], Chorus [Off, 0~127], Velocity [On, 1~127], Express [Off, Bellows, Pedal]
6. ORCHESTRA EDIT		
6.1 Orchestra Octave	Value	-1~0~1
6.2 Orchestra Volume	Level	Off, -30~Std~30

6.3 Bellows Detune	Type	Off, Low, Standard, High
6.4 Reverb Send	Level	0~127
6.5 Chorus Send	Level	0~127
6.6 Delay Send	Level	0~127
6.7 Aftertouch Pitch	Mode	Off, 1/4 Down, 1/2 Down, 1/4 Up, 1/2 Up
6.8 Orchestra MIDI TX	Message & value	Note [On,Off], Octave [-3~0~3], CC 00 [Off, 0~127], CC 32 [Off, 0~127], PC [Off, 1~128], Volume [Off, 0~127], Panpot [Off, 0~127], Reverb [Off, 0~127], Chorus [Off, 0~127], Velocity [On, 1~127], Express [Off, Bellows, Pedal], AfterT. [On,Off]

7. SET COMMON

7.1 Reverb Macro Type	Type	Room1, Room2, Room3, Hall1, Hall2, Plate, Delay, Panning Dly
	Level	0~127
7.2 Reverb Parameters	Parameters	Character [0~7], Pre-LPF [0~7], Time [0~127], Level [0~127], DlyFback [0~127], Pre-DlyT. [0~127]
7.3 Chorus Macro Type	Macro Type	Chorus1, Chorus2, Chorus3, Chorus4, FBackChr, Flanger, ShortDelay, ShortDlyFB
7.4 Chorus Parameters	Parameters	Pre-LPF [0~7], Level [0~127], Feedback [0~127], Delay [0~127], Rate [0~127], Depth [0~127], Chr>Rev [0~127], Chr>Dly [0~127]
7.5 Delay Macro Type	Type	Delay1, Delay2, Delay3, Delay4, PanDelay1, PanDelay2, PanDelay3, PanDelay4, Delay>Rev, PanRepeat
7.6 Delay Parameters	Parameters	Pre-LPF [0~7], Level [0~127], Time L(%) [4%~500%], Time C(ms/s) [0.1~1000], Time R(%) [4%~500%], Level L [0~127], Level C [0~127], Level R [0~127], Feedback [-64~0~63], Dly>Rev [0~127]
7.7 Name	Characters	See the character table below.
7.8 Master Bar Recall	Register	1~14
7.9 Icon	Bitmap	1~40 Preset

8. SYSTEM

8.1 LCD Contrast*	Value	1~7 (Default setting: 5)
8.2 Parameter Access	Mode	Easy, Full
8.3 Bellows Curve*	Type	Fixed Low, Fixed Med, Fixed High, X-Light, Light, Standard, Heavy, X-Heavy
8.4 Pedal Controller*	Switch	1~5
	Assign	Set Up, Set Down, Regist Up, Regist Dwn, Treble Sust, Bass Sust, Chord Sust, Orch.Sust, OrchBs Sust, Orch.On/Off, Start/Stop, Intro, Fill Up, Fill Down, Ending, Set 1~40, Register 1~14 independent for each switch
8.5 Bass & Chord Mode*	Type	2 Bass Rows, 3 Bass Rows
8.6 Free Bass Mode*	Type	minor 3rd, Bajan, Fifth, N.Europe
8.7 Stereo Width*	Type	-1~63, Full
8.8 Auto Power OFF*	Type	Disabled, 10 min., 15 min., 20 min.
8.9 Startup*	Type	Set [1~40], Bass Link [On/Off], Orch Link [On/Off],
	Assign	1~40 only for Set type, On/Off
8.10 Startup Name*	Name	8 characters [_____ default]
8.11 Orch. Bass Touch	Value	Off, Low, Medium, High, Bellows

9. UTILITY

9.1 Battery Status	Adapter, Recharging, NO BATTERY	
9.2 Copy ALL Effects	From	Set 1~40
	To	Set 1~40
9.3 Copy Reverb	From	Set 1~40
	To	Set 1~40
9.4 Copy Chorus	From	Set 1~40
	To	Set 1~40
9.5 Copy Delay	From	Set 1~40
	To	Set 1~40
9.6 Copy SET	From	Set 1~40
	To	Set 1~40
9.7 Bulk Dump ALL	Press WRITE to transmit	
9.8 Bulk Dump SET	Press WRITE to transmit	
9.9 Restore SET	Factory Set 1~40	

Character table									
16'	8'	8' -4'	4'	2'	(Only for Bass and Free Bass)				
	!	"	#	\$	%	&	()	*
+	-	.	/	0	1	2	3	4	5
6	7	8	9	:	;	<	=	>	?
@	A	B	C	D	E	F	G	H	I
J	K	L	M	N	O	P	Q	R	S
T	U	V	W	X	Y	Z	[\]
^	`	a	b	c	d	e	f	g	h
i	j	k	l	m	n	o	p	q	r
s	t	u	v	w	x	y	z		

10. MIDI		
10.1 RealTime RX-TX	Part	Treble (1), Bass/Free (2), Chord (3), Orchestra (4), OrcBass (5), Basic Ch (13)
	RX-TX *	Off, 1~16 (can be set for each part)
10.2 Ext. Seq. Playback*	Part	Treble, Bass-Chord, Orchestra
	Value	On, Off (can be set for each part)
10.3 Bellows TX Resolution*	Value	High, Medium, Low

(*) are Global parameters

Factory Sets

01 CONCERTO	11 CAJUN	21 SCOTTISH	31 EMPTY
02 CLASSIC	12 TEX MEX	22 IRISH	32 EMPTY
03 JAZZ	13 OldPARIS	23 CELTIC	33 EMPTY
04 "I" FOLK (Italian Folk)	14 CiaoROME	24 XLowReed	34 EMPTY
05 "D" FOLK (German Folk)	15 DiatFOLK	25 HalfVALV	35 EMPTY
06 "F" FOLK (French Folk)	16 STUDIO	26 FUTURE	36 EMPTY
07 "SP" FOLK (Spanish Folk)	17 TRDITION	27 MUSETTE	37 EMPTY
08 BallROOM	18 BAROQUE	28 BASSOON	38 EMPTY
09 BANDNEON	19 ROMANTIC	29 MASTER	39 EMPTY
10 ALPINE	20 CONCERTN	30 EXAMPLES	40 V-Set

Demo Songs

#	DISPLAYED NAME*	SONG TITLE	PERFORMED BY
01	OldPARIS	Walking in old Paris by S. Scappini	Sergio Scappini
02	"I" FOLK	Carnival in Venice - Traditional	Sergio Scappini
03	BANDNEON	Passionate Red Rose by S. Scappini	Sergio Scappini
04	"D" FOLK	Bezaubernder Sinaklia by S. Scappini	Sergio Scappini
05	NAPLES	O Sole Mio - Traditional	Sergio Scappini
06	CLASSIC	Sonata in C Maj by D. Scarlatti	Sergio Scappini
07	ALPINE	Edelweiss by S. Scappini	Sergio Scappini
08	TEX MEX	Mexican Hat Dance - Traditional	Luigi Bruti
09	BAROQUE	Smells from Toccata by J. S. Bach	Sergio Scappini
10	CAPRICCIO	Capriccio 13 by N. Paganini	Sergio Scappini
11	GarageTNGO	Salvador by L. Bruti	Luigi Bruti
12	JAZZ	Scattered Jazz by S. Scappini	Sergio Scappini
13	BellwSHAKE	Figaro by G. Rossini	Sergio Scappini
14	CELTIC	Trinity Knots by L. Bruti	Luigi Bruti
15	MUSETTE	Rêve d'amour by L. Bruti	Luigi Bruti
16	CAJUN	Sugar cane by L. Bruti	Luigi Bruti
17	DiatFOLK	To my beloved teacher by S. Scappini	Sergio Scappini
18	9th Bossa	9th Bossa by Yoshiaki Sato	Yoshiaki Sato
19	Sng FarEast	Song from Far East by Yoshiaki Sato	Yoshiaki Sato
20	ZakZak Funk	Zak-Zak Funk by Yoshiaki Sato	Yoshiaki Sato
21	O&B 4Beat	O&B 4Beat by Yoshiaki Sato	Yoshiaki Sato

[*] Note: #1~17 Copyright ©2004 Roland Europe Spa. All rights reserved.

#18~21: Copyright ©2004 febbre. All rights reserved.

Unauthorized use of the demo songs for purposes other than private enjoyment is a violation of applicable laws.

Note: The performance data of the demo songs are not transmitted to the MIDI OUT socket.

9. MIDI implementation

1. Received data

■ Channel Voice Messages

● Note off

Status	2nd byte	3rd byte
8nH	kkH	vvH
n = MIDI channel number:	0H-FH (Ch.1~16)	
kk = note number:	00H-7FH (0~127)	
vv = note off velocity:	00H-7FH (0~127)	

● Note on

Status	2nd byte	3rd byte
9nH	kkH	vvH
n = MIDI channel number:	0H-FH (Ch.1~16)	
kk = note number:	00H-7FH (0~127)	
vv = note on velocity:	01H-7FH (1~127)	

● Control Change

- The value specified by a Control Change message is not reset by a Program Change, etc.

○ Bank Select (Controller number 0, 32)

Status	2nd byte	3rd byte
BnH	00H	mmH
BnH	20H	llH
n = MIDI channel number:	0H-FH (Ch.1~16)	
mm = Bank number MSB:	00H-7FH	
ll = Bank number LSB:	00H-7FH	

- Only for Free Bass.

○ Expression (Controller number 11)

Status	2nd byte	3rd byte
BnH	0BH	vvH
n = MIDI channel number:	0H-FH (Ch.1~16)	
vv = Expression:	00H-7FH (0~127)	

- This adjusts the volume of a Part. It can be used independently from Volume (CC07) messages. Expression messages are used for musical expression within a performance, e.g., expression pedal movements, crescendo and decrescendo.

○ Hold 1 (Controller number 64)

Status	2nd byte	3rd byte
BnH	40H	vvH
n = MIDI channel number:	0H-FH (Ch.1~16)	
vv = Control value:	00H-7FH (0~127)	00H-63H= Off/64H-7FH= On

○ Program Change

Status	2nd byte	3rd byte
CnH	ppH	
n = MIDI channel number:	0H-FH (Ch.1~16)	
pp = Program number:	00H-0DH: Treble Register 1~14	
	00H-15H: Orchestra Register 1~22	
	00H-06H: Bass/FreeBass/Orch.Bass Register 1~7	
	00H-27H: Set 1~40	

○ Channel Pressure

Status	2nd byte	3rd byte
DnH	vvH	
n = MIDI channel number:	0H-FH (Ch.1~16)	
vv = Channel Pressure:	00H-7FH (0~127)	

■ System Realtime Messages

○ Active Sensing

Status
FEH
When Active Sensing is received, the FR-7/FR-5 starts monitoring the intervals of all further messages. While monitoring, if the interval between messages exceeds 420 ms, the same processing will be carried out as when All Sounds Off, All Notes Off and Reset All Controllers are received, and message interval monitoring will be halted.

○ Start

Status
FAH
When an FA message is received from an external MIDI device such as sequencer, the FR-7/FR-5 sends all necessary MIDI information for a song header setup: Treble, Orchestra, Bass/Free, Orchestra Bass, sound setup.

■ System Exclusive Messages

Status	Data byte	Status
F0H	iiH, ddH,, eeH	F7H
F0H:	System Exclusive Message status	
ii = ID number:	An ID number (manufacturer ID) to indicate the manufacturer whose Exclusive message this is. Roland's manufacturer ID is 41H.	
dd, ..., ee = data:	00H-7FH (0~127)	
F7H:	EOX (End Of Exclusive)	

The System Exclusive Messages received by the FR-7/FR-5 are messages related to Data Set (DT).

● Data Set 1 DT1 (12H)

Status	Data byte	Status
F0H	41H, dev, 42H, 12H, aaH, bbH, ccH, ddH, ... eeH, ffH, sum	F7H
Byte	Explanation	
F0H	Exclusive status	
41H	ID number (Roland)	
10H	Device ID	
00H	Model ID #1 (FR-7/FR-5 V-Accordion)	
7CH	Model ID #2 (FR-7/FR-5 V-Accordion)	
12H	Command ID (DT1)	
aaH	Address MSB: upper byte of the starting address of the data to be sent	
bbH	Address: upper middle byte of the starting address of the data to be sent	
ccH	Address: lower middle byte of the starting address of the data to be sent	
ddH	Address LSB: lower byte of the starting address of the data to be sent	
eeH	Data: the actual data to be sent. Multiple bytes of data are transmitted in order starting from the address.	
::	::	
ffH	Data	
sum	Checksum	
F7H	EOX (End of Exclusive)	

- The amount of data that can be received at one time depends on the type of data, and data will be transmitted from the specified starting address and size.
- Data larger than 256 bytes must be divided into packets of 256 bytes or less, and each packet must be sent at an interval of about 20ms.

2. Transmitted data

■ Channel Voice Messages

● Note off

Status	2nd byte	3rd byte
8nH	kkH	vvH
n = MIDI channel number:	0H-FH (Ch.1~16)	
kk = note number:	00H-7FH (0~127)	
vv = note off velocity:	00H-7FH (0~127)	

● Note on

Status	2nd byte	3rd byte
9nH	kkH	vvH
n = MIDI channel number:	0H-FH (Ch.1~16)	
kk = note number:	00H-7FH (0~127)	
vv = note on velocity:	01H-7FH (1~127)	

● Control Change

○ Bank Select (Controller number 0, 32)

Status	2nd byte	3rd byte
BnH	00H	mmH
BnH	20H	llH
n = MIDI channel number:	0H-FH (Ch.1~16)	
mm = Bank number MSB:	00H-7FH	
ll = Bank number LSB:	00H-7FH	

○ Volume (Controller number 7)

Status	2nd byte	3rd byte
BnH	07H	vvH
n = MIDI channel number:	0H-FH (Ch.1~16)	
vv = Volume:	00H-7FH (0~127), Initial value = 64H (100)	

- Volume messages are used to adjust the volume balance of each Part.

○ Pan (Controller number 10)

Status	2nd byte	3rd byte
BnH	0AH	vvH
n = MIDI channel number:	0H~FH (Ch.1~16)	
vv = pan:	00H~40H~7FH (Left~Center~Right), Initial value = 40H (Center)	

○ Expression (Controller number 11)

Status	2nd byte	3rd byte
BnH	0BH	vvH
n = MIDI channel number:	0H~FH (Ch.1~16)	
vv = Expression:	00H~7FH (0~127)	
• This adjusts the volume of a Part. Expression messages are used for musical expression within a performance, e.g., expression pedal movements, crescendo and decrescendo.		

○ Hold 1 (Controller number 64)

Status	2nd byte	3rd byte
BnH	40H	vvH
n = MIDI channel number:	0H~FH (Ch.1~16)	
vv = Control value:	00H~7FH (0~127) 00H~63H= Off/64H~7FH= On	

○ Effect 1 (Reverb Send Level) (Controller number 91)

Status	2nd byte	3rd byte
BnH	5BH	vvH
n = MIDI channel number:	0H~FH (Ch.1~16)	
vv = Reverb Send Level:	00H~7FH (0~127), Initial value = 28H (40)	
• This message adjusts the Reverb Send Level of each Part.		

○ Effect 3 (Chorus Send Level) (Controller number 93)

Status	2nd byte	3rd byte
BnH	5DH	vvH
n = MIDI channel number:	0H~FH (Ch.1~16)	
vv = Chorus Send Level:	00H~7FH (0~127), Initial value = 00H (0)	

○ Program Change

Status	2nd byte
CnH	ppH
n = MIDI channel number:	0H~FH (Ch.1~16)
pp = Program number:	00H~7FH: program no. 1~128

○ Channel Pressure

Status	2nd byte
DnH	vvH
n = MIDI channel number:	0H~FH (Ch.1~16)
vv = Channel Pressure:	00H~7FH (0~127)

■ System Realtime Messages

○ Active Sensing

Status	Data
FEH	Transmitted about every 250ms.

○ Start

Status	Data
FAH	This message is transmitted when a footswitch of FBC-7 Pedal, programmed as Start/Stop, is pressed.

○ Stop

Status	Data
FCH	This message is transmitted when a footswitch of FBC-7 Pedal, programmed as Start/Stop, is pressed.

■ System Exclusive Messages

Status	Data byte	Status
F0H	iiH, ddH,,eeH	F7H
F0H:	System Exclusive Message status	
ii = ID number:	An ID number (manufacturer ID) to indicate the manufacturer whose Exclusive message this is. Roland's manufacturer ID is 41H.	
dd, ..., ee= data:	00H~7FH (0~127)	
F7H:	EOX (End Of Exclusive)	

The System Exclusive Messages transmitted by the FR-7/FR-5 are messages related to Data Set (DT).

● Data Set 1 DT1 (12H)

Status	Data byte	Status
F0H	41H, dev, 42H, 12H, aaH, bbH, ccH, ddH, ... eeH, ffH, sum	F7H
Byte	Explanation	
F0H	Exclusive status	
41H	ID number (Roland)	
10H	Device ID	
00H	Model ID #1 (FR-7/FR-5 V-Accordion)	
7CH	Model ID #2 (FR-7/FR-5 V-Accordion)	
12H	Command ID (DT1)	
aaH	Address MSB: upper byte of the starting address of the data to be sent	

Status	Data byte	Status
bbH	Address: upper middle byte of the starting address of the data to be sent	
ccH	Address: lower middle byte of the starting address of the data to be sent	
ddH	Address LSB: lower byte of the starting address of the data to be sent	
eeH	Data: the actual data to be sent. Multiple bytes of data are transmitted in order starting from the address.	
::	::	
ffH	Data	
sum	Checksum	
F7H	EOX (End of Exclusive)	

- The amount of data that can be transmitted at one time depends on the type of data, and data will be transmitted from the specified starting address and size.
- Data larger than 256 bytes will be divided into packets of 256 bytes or less, and each packet will be sent at an interval of about 20ms.

3. Bulk Dump

Bulk Dump allows you to transmit a large amount of data at once, and is convenient for storing settings for the entire unit on a computer or sequencer. The FR-7/FR-5 is able to transmit and receive a SET.

4. Program change messages

BANK SELECT		PROGRAM CHANGE		REGISTER	SET RX (PC)	
MSB CC00	LSB CC32					
TREBLE REGISTER RX						
--	--	1	Bassoon	1	CONCERTO	
--	--	2	Bandon	2	CLASSIC	
--	--	3	Cello	3	JAZZ	
--	--	4	Harmon	4	"I" FOLK	
--	--	5	Organ	5	"D" FOLK	
--	--	6	Accord	6	"F" FOLK	
--	--	7	Violin	7	"SP" FOLK	
--	--	8	Master	8	BallROOM	
--	--	9	Musette	9	BANDNEON	
--	--	10	Celeste	10	ALPINE	
--	--	11	Tremolo	11	CAJUN	
--	--	12	Clarinet	12	TEX MEX	
--	--	13	Oboe	13	OldPARIS	
--	--	14	Piccolo	14	CiaoROME	
ORCHESTRA REGISTER RX						
--	--	1	Trombone	15	DiatFOLK	
--	--	2	Trumpet	16	STUDIO	
--	--	3	Tenor Sax	17	TRDITION	
--	--	4	Alto Sax	18	BAROQUE	
--	--	5	Clarinet	19	ROMANTIC	
--	--	6	Oboe	20	CONCERTN	
--	--	7	Harmonica	21	SCOTTISH	
--	--	8	Mute Harm	22	IRISH	
--	--	9	Violin	23	CELTIC	
--	--	10	Pizzicato	24	XLowReed	
--	--	11	Flute	25	HalfVALV	
--	--	12	Pan Flute	26	FUTURE	
--	--	13	HighLand	27	MUSETTE	
--	--	14	Zampogna	28	BASSOON	
--	--	15	PercOrgan	29	MASTER	
--	--	16	JazzOrgan	30	EXAMPLES	
--	--	17	RotOrgan	31	EMPTY	
--	--	18	TremOrg	32	EMPTY	
--	--	19	ScatVoice	33	EMPTY	
--	--	20	Mandolin	34	EMPTY	
--	--	21	AcGuitar	35	EMPTY	
--	--	22	AcPiano	36	EMPTY	
BASS REGISTER RX						
--	0	1	2'	37	EMPTY	
--	0	2	4'	38	EMPTY	
--	0	3	8-4'	39	EMPTY	
--	0	4	16'/8'-4'/4'/2'	40	EMPTY	
--	0	5	8'/4'/2'			
--	0	6	16'/8'-4'			
--	0	7	16'/2'			
FREE BASS REGISTER RX						
--	1	1	low			
--	1	2	high			
--	1	3	low+high			
--	1	4	lw+hglow			
--	1	5	lw/low+hi			
--	1	6	highlw+h			
--	1	7	lowhigh			
ORCH BASS REGISTER RX						
--	--	1	Acoustic			
--	--	2	Bowed			
--	--	3	Fingered			
--	--	4	Fretless			
--	--	5	Picked			
--	--	6	Tuba			
--	--	7	Tuba Mix			

MIDI Implementation Chart

[V-Accordion]

Model: FR-7/FR-5

Date: January 2004

Version: 1.00

Function...		Transmitted	Recognized	Remarks
Basic Channel	Default Changed	1~16 1~16, Off	1~16 1~16, Off	5 parts: 1= Treble, 2= Bass/ Free Bass, 3= Chord, 5= Orchestra Bass, 4= Orchestra 1 logical part: 13= Basic Ch for Set change
Mode	Default Message Altered	Mode 3 ***** *****	Mode 3 *****	
Note Number	True Voice	0~127 *****	*1 0~127 0~127	
Velocity	Note ON Note OFF	O O	*1 O O	
After Touch	Key's Ch's	X O	*1 X O	
Pitch Bend		X	X	
Control Change		0,32 7 10 11 64 91 93	O *1 O *1 O *1 O *1 X *1 X	Bank Select Volume Panpot Expression Hold 1 Reverb Send Chorus Send
Program Change	True #	O 0~127	*1 O 0~39	Program Number 1~128 transmitted Recognized: 1~40: 1~14: Treble Registers 1~7 Bass 1~7 Free Bass 1~7 Orchestra Bass 1~22 Orchestra 1~40 Sets
System Exclusive		O	O *3	
System Common	Song Position Pointer Song Sel Tune	X X X	X X X	
System Real Time	Clock Commands	X X	*1 X O *4	
Aux Messages	All Sounds Off Reset All Controllers Local On/Off All Notes Off Active Sense Reset	X X X X O X	X X X X O X	
Notes		*1 O X is selectable *2 Recognized as M=1 even if M≠1 *3 SysEx used for Bulk Dump only *4 Received Start (FA) sends current sound setup		

Mode 1: OMNI ON, POLY
Mode 3: OMNI OFF, POLY

Mode 2: OMNI ON, MONO
Mode 4: OMNI OFF, MONO

O: Yes
X: No

10. Information

When you need repair service, call your nearest Roland Service Center or authorized Roland distributor in your country as shown below.

AFRICA

EGYPT

Al Fanny Trading Office
9, EBN Hagar A1 Askalany Street,
ARD El Golf, Heliopolis,
Cairo 11341, EGYPT
TEL: 20-2-417-1828

REUNION

Maison FO - YAM Marcel
25 Rue Jules Hermann,
Chaudron - BP79 97 491
Ste Clotilde Cedex,
REUNION ISLAND
TEL: (0262) 218-429

SOUTH AFRICA

Tha Other Music Shop(PTY)Ltd.
11 Melle St., Braamfontein,
Johannesburg,
SOUTH AFRICA
TEL: (011) 403 4105
FAX: (011) 403 1234

Paul Bothner(PTY)Ltd.
17 Werdmuller Centre,
Main Road, Claremont 7708
SOUTH AFRICA
TEL: (021) 674 4030

ASIA

CHINA

Roland Shanghai Electronics Co.,Ltd.
5F, No.1500 Pingliang Road
Shanghai 200090, CHINA
TEL: (021) 5580-0800

Roland Shanghai Electronics Co.,Ltd.
(BEIJING OFFICE)
10F, No.18 3 Section Anhuaxili
Chaoyang District Beijing
100011 CHINA
TEL: (010) 6426-5050

Roland Shanghai Electronics Co.,Ltd.
(GUANGZHOU OFFICE)
2/F, No.30 Si You Nan Er Jie
Yi Xiang, Wu Yang Xin Cheng,
Guangzhou 510600, CHINA
TEL: (020) 8736-0428

HONG KONG
Tom Lee Music Co., Ltd.
Service Division
22-32 Pun Shan Street, Tsuen
Wan, New Territories,
HONG KONG
TEL: 2415 0911

Parsons Music Ltd.
8th Floor, Railway Plaza, 39
Chatham Road South, T.S.T,
Kowloon, HONG KONG
TEL: 2333 1863

INDIA

Rivera Digitec (India) Pvt. Ltd.
409, Nirman Kendra
Mahalaxmi Flats Compound
Off. Dr. Edwin Moses Road,
Mumbai-400011, INDIA
TEL: (022) 2493 9051

INDONESIA

PT Citra IntiRama
Jl. Cideng Timur No. 15J-150
Jakarta Pusat
INDONESIA
TEL: (021) 6324170

KOREA

Cosmos Corporation
1461-9, Seocho-Dong,
Seocho Ku, Seoul, KOREA
TEL: (02) 3486-8855

MALAYSIA

Roland Asia Pacific Sdn. Bhd.
45-1, Block C2, Jalan PPU 1/39,
Dataran Prima, 47301 Petaling
Jaya, Selangor, MALAYSIA
TEL: (03) 7805-3263

PHILIPPINES

G.A. Yupangco & Co. Inc.
339 Gil J. Puyat Avenue
Makati, Metro Manila 1200,
PHILIPPINES
TEL: (02) 899 9801

SINGAPORE

CRISTOFORI MUSIC PTE LTD
Blk 3014, Bedok Industrial Park E,
#02-2148, SINGAPORE 489980
TEL: 6243-9555

TAIWAN

ROLAND TAIWAN ENTERPRISE CO., LTD.
Room 5, 9th, No. 112 Chung
Shan N.Road Sec.2, Taipei,
TAIWAN, R.O.C.
TEL: (02) 2561 3339

THAILAND

Theera Music Co., Ltd.
330 Verg NakornKasem, Soi 2,
Bangkok 10100, THAILAND
TEL: (02) 2248821

VIETNAM

Saigon Music
Suite D1-8
40 Ba Huyen Thanh Quan Street
Hochiminh City, VIETNAM
TEL: (08) 930-1969

AUSTRALIA/ NEW ZEALAND

AUSTRALIA/ NEW ZEALAND

Roland Corporation Australia Pty., Ltd.
38 Campbell Avenue
Dee Why West, NSW 2099
AUSTRALIA

For Australia
Tel: (02) 9982 8266
For New Zealand
Tel: (09) 3098 715

CENTRAL/LATIN AMERICA

ARGENTINA

Instrumentos Musicales S.A.
Av.Santa Fe 2055
(1123) Buenos Aires
ARGENTINA
TEL: (011) 4508-2700

BARBADOS

A&B Music Supplies LTD
12 Webster Industrial Park
Wildely, StMichael, Barbados
TEL: (246)430-1100

BRAZIL

Roland Brasil Ltda.
Rua San Jose, 780 Sala B
Parque Industrial San Jose
Coia - Sao Paulo - SP, BRAZIL
TEL: (011) 4615 5666

CHILE

Comercial Fancy II S.A.
Rut: 96 919 420-1
Nataziel Cox #739, 4th Floor
Santiago - Centro, CHILE
TEL: (02) 688-9540

COLOMBIA

Centro Musical Ltda.
Cra 43 B No 25 A 41 Bododega 9
Medellin, Colombia
TEL: (574)3812529

COSTA RICA

JUAN Bansbach Instrumentos Musicales
Ave.1, Calle 11, Apartado 10237,
San Jose, COSTA RICA
TEL: 258-0211

CURACAO

Zeelandia Music Center Inc.
Orionweg 30
Curacao, Netherland Antilles
TEL:(305)5926866

DOMINICAN REPUBLIC

Instrumentos Fernando Giraldez
Calle Proyecto Central No.3
Ens.La Esperilla
Santo Domingo,
Dominican Republic
TEL:(809) 683 0305

ECUADOR

Mas Musica
Rumichaca 822 y Zaruma
Guayaquil - Ecuador
TEL:(593-4)2302364

EL SALVADOR

OMNI MUSIC
75 Avenida Norte y Final
Alameda Juan Pablo II,
Edificio No.4010 San Salvador,
EL SALVADOR
TEL: 262-0788

GUATEMALA

Casa Instrumental
Calzada Roosevelt 34-01,zona 11
Ciudad de Guatemala
Guatemala
TEL:(502) 599-2888

HONDURAS

Almaen Pajaro Azul S.A. de C.V.
BO.Paz Barahona
3 Ave.11 Calle S/O
San Pedro Sula, Honduras
TEL: (504) 553-2029

MARTINIQUE

Musique & Son
Z.I.Les Mangle
97232 Le Lamantin
Martinique F.W.I.
TEL: 596 596 426860

Gigamusic SARRL

10 Rte De La Folie
97200 Fort De France
Martinique F.W.I.
TEL: 596 596 715222

MEXICO

Casa Veerkamp, s.a. de cv.
Av. Toluca No. 323, Col. Olivar
de los Padres 01780 Mexico
D.F. MEXICO
TEL: (55) 5668-6699

NICARAGUA

Bansbach Instrumentos Musicales Nicaragua
Altamira D'Este Calle Principal
de la Farmacia 5ta Avenida
1 Cuadra al Lago #503
Managua, Nicaragua
TEL: (505)277-2557

PANAMA

SUPRO MUNDIAL, S.A.
Boulevard Andrews, Albrook,
Panama City, REP. DE
PANAMA
TEL: 315-0101

PARAGUAY

Distribuidora De Instrumentos Musicales
J.E. Olear y ESQ. Manduvira
Asuncion PARAGUAY
TEL: (595) 21 492147

PERU

Audionet
Distribuciones Musicales SAC
Juan Fanning 530
Miraflores
Lima - Peru
TEL: (511) 4461388

TRINIDAD

AMR Ltd
Ground Floor
Maritime Plaza
Barataria Trinidad W.I.
TEL: (868)638 6385

URUGUAY

Todo Musica S.A.
Francisco Acuna de Figueroa
1771
C.P.: 11.800
Montevideo, URUGUAY
TEL: (02) 924-2335

VENEZUELA

Instrumentos Musicales Allegro,C.A.
Av.las industrias edf.Guitar
import
#7 zona Industrial de Turumo
Caracas, Venezuela
TEL: (212) 244-1122

EUROPE

AUSTRIA

Roland Elektronische Musikinstrumente HmbH.
Austrian Office
Eduard-Bodem-Gasse 8,
A-6020 Innsbruck, AUSTRIA
TEL: (0512) 26 44 260

BELGIUM/FRANCE/ HOLLAND/ LUXEMBOURG

Roland Central Europe N.V.
Houtstraat 3, B-2260, Oevel
(Westerlo) BELGIUM
TEL: (014) 575811

CZECH REP.

K-AUDIO
Kardasovska 626,
CZ-198 00 Praha 9,
CZECH REP.
TEL: (2) 666 10529

DENMARK

Roland Scandinavia A/S
Nordhavnsvej 7, Postbox 880,
DK-2100 Copenhagen
DENMARK
TEL: 3916 6200

FINLAND

Roland Scandinavia As, Filial Finland
Elannonitie 5
FIN-01510 Vantaa, FINLAND
TEL: (09) 68 24 020

GERMANY

Roland Elektronische Musikinstrumente HmbH.
Oststrasse 96, 22844
Norderstedt, GERMANY
TEL: (040) 52 60090

GREECE

STOLLAS S.A.
Music Sound Light
155, New National Road
Patras 26442, GREECE
TEL: 2610 435400

HUNGARY

Roland East Europe Ltd.
Warehouse Area 'DEPO' Pf.83
H-2046 Torokbalint,
HUNGARY
TEL: (23) 511011

IRELAND

Roland Ireland
G2 Calmout Park, Calmout
Avenue, Dublin 12
Republic of IRELAND
TEL: (01) 4294444

ITALY

Roland Italy S. p. a.
Viale delle Industrie 8,
20020 Arese, Milano, ITALY
TEL: (02) 937-78300

NORWAY

Roland Scandinavia Avd.
Kontor Norge
Lilleakerveien 2 Postboks 95
Lilleaker N-0216 Oslo
NORWAY
TEL: 2273 0074

POLAND

MX MUSIC SP.Z.O.O.
UL. Gibraltarska 4.
PL-03664 Warszawa POLAND
TEL: (022) 679 44 19

PORTUGAL

Roland Iberia, S.L.
Portugal Office
Cais das Pedras, 8/9-1 Dto
4050-465, Porto, PORTUGAL
TEL: 22 608 00 60

ROMANIA

FBS LINES
Piata Libertatii 1,
535500 Gheorgheni,
ROMANIA
TEL: (266) 364 609

RUSSIA

MuTek
3-Bogatyrskaya Str. 1.k.1
107 564 Moscow, RUSSIA
TEL: (095) 169 5043

SPAIN

Roland Iberia, S.L.
Paseo Garcia Faria, 33-35
08005 Barcelona SPAIN
TEL: 93 495 91 00

SWEDEN

Roland Scandinavia A/S
SWEDISH SALES OFFICE
Danvik Center 28, 2 tr.
S-131 30 Nacka SWEDEN
TEL: (08) 702 00 20

SWITZERLAND

Roland (Switzerland) AG
Landstrasse 5, Postfach,
CH-4452 Itingen,
SWITZERLAND
TEL: (061) 927-8383

UKRAINE

TIC-TAC
Mira Str. 19/108
P.O. Box 180
295400 Munkachevo,
UKRAINE
TEL: (03131) 414-40

UNITED KINGDOM

Roland (U.K.) Ltd.
Atlantic Close, Swansea
Enterprise Park, SWANSEA
SA7 9JF,
UNITED KINGDOM
TEL: (01792) 702701

MIDDLE EAST

BAHRAIN

Moon Stores
No.16, Bab Al Bahrain Avenue,
P.O.Box 247, Manama 304,
State of BAHRAIN
TEL: 17 211 005

CYPRUS

Radex Sound Equipment Ltd.
17, Diagorou Street, Nicosia,
CYPRUS
TEL: (022) 66-9426

IRAN

MOCO INC.
No.41 Nike St., Dr.Shariyati Ave.,
Roberoye Cerahe Mirdamad
Tehran, IRAN
TEL: (021) 285-4169

ISRAEL

Halilit P. Greenspoon & Sons Ltd.
8 Retzif Ha'aliya Hashnya St.
Tel-Aviv-Yafo ISRAEL
TEL: (03) 6823666

KUWAIT

EASA HUSAIN AL-YOUSIFI & SONS CO.
Abdullah Salem Street,
Safat, KUWAIT
TEL: 243-6399

LEBANON

Chahine S.A.L.
Gerge Zeidan St., Chahine
Bldg., Achrafieh, P.O.Box: 16-
5857
Beirut, LEBANON
TEL: (01) 20-1441

OMAN

TALENTZ CENTRE L.L.C.
P.O. BOX 37, MUSCAT,
POSTAL CODE 113
TEL: 931-3705

QATAR

Al Emadi Co. (Badie Studio & Stores)
P.O. Box 62, Doha, QATAR
TEL: 4423-554

SAUDI ARABIA

aDawiah Universal Electronics APL
Corniche Road, Aldossary
Bldg., 1st Floor, Alkhobar,
SAUDI ARABIA

P.O.Box 2154, Alkhobar 31952
SAUDI ARABIA
TEL: (03) 898 2081

SYRIA

Technical Light & Sound Center
Rawda, Abdul Qader Jazairi St.
Bldg. No. 21, P.O.BOX 13520,
Damascus, SYRIA
TEL: (011) 223-5384

TURKEY

Ant Muzik Aletleri Ithalat Ve Ihracat Ltd Sti
Siraselviler Caddesi
Siraselviler Pasaji No:74/20
Taksim - Istanbul, TURKEY
TEL: (0212) 2449624

U.A.E.

Zak Electronics & Musical Instruments Co. L.L.C.
Zabeel Road, Al Sherooq Bldg.,
No. 14, Grand Floor, Dubai,
U.A.E.
TEL: (04) 3360715

NORTH AMERICA

CANADA

Roland Canada Music Ltd.
(Head Office)
5480 Parkwood Way
Richmond B. C., V6V 2M4
CANADA
TEL: (604) 270 6626

Roland Canada Music Ltd.

(Toronto Office)
170 Admiral Boulevard
Mississauga On L5T 2N6
CANADA
TEL: (905) 362 9707

U. S. A.

Roland Corporation U.S.
5100 S. Eastern Avenue
Los Angeles, CA 90040-2938,
U. S. A.
TEL: (323) 890 3700

11. Index

- A**
- AfterT.....74
 - Aftertouch25
 - PitchDown.....42, 54
 - Alpine29, 42
 - American.....29, 42
 - Arabic29
 - Auto Power OFF.....62
- B**
- Bagpipe sounds.....25
 - Balance20, 22
 - Bandoneon.....41, 42, 45, 46, 48, 49
 - Bass
 - & Chord Mode.....61
 - Edit.....45
 - Link.....42
 - MIDI TX.....47
 - Orchestra.....27
 - Panel functions.....12
 - Sust.....60
 - Touch.....63
 - Using.....22
 - Battery.....9, 32
 - Status.....63
 - Battery Charger.....32
 - Bellows
 - Curve.....60
 - Detune.....42, 47, 49, 53
 - TX Resolution.....71
 - Bend.....54
 - Bending notes.....42
 - Bulk
 - Dump.....75
 - Reception.....76
 - Button.....30
 - Level.....30
 - Noise.....46, 49
- C**
- Cajun.....41, 42, 45, 46, 48, 49
 - Cancel.....24, 27
 - Cassotto.....20, 41
 - CC00.....73
 - CC32.....73
 - Character.....56
 - Charging.....32
 - Chord.....22, 61, 67
 - MIDI TX.....47
 - Chord Sust.....60
 - Chorus.....21, 64
 - Macro Type.....56
 - MIDI.....74
 - Parameters.....57
 - Send.....42, 47, 49, 52, 54
 - Classic.....29, 41, 42, 45, 46, 48, 49
 - Classic2.....41, 42, 45, 46, 48, 49
 - Common.....55
 - Connections.....14
 - Contrast.....60
- D**
- Copy
 - All Effects.....64
 - Chorus.....64
 - Delay.....64
 - Reverb.....64
 - Set.....64
 - Copying.....64
 - Copying settings.....64
 - Curve.....60
- D**
- Data.....26
 - Data Write Error.....80
 - Delay.....21, 56, 57, 64
 - Fback.....56
 - Macro Type.....58
 - Parameters.....58
 - Send.....42, 47, 49, 52, 54
 - Demo songs.....16
 - Detune.....28, 42, 47, 49, 53
 - D-Folk.....29, 41, 42, 45, 46, 48, 49
 - Display.....18, 60
 - Drone.....25
 - Dry.....29, 42
 - Dual.....25
 - Dynamics.....25
- E**
- Easy.....18
 - Echo.....21, 58
 - Editing.....35
 - Effect
 - Chorus.....21
 - Copying.....64
 - Delay.....21
 - Level.....21
 - Reverb.....21
 - Ending.....61
 - Enter.....26
 - Equal.....29
 - Expression.....74
 - Pedal.....31
 - Ext. Seq. Playback.....70
 - External Battery Charger.....32, 33
- F**
- Factory Setup.....78
 - FBC-7.....31
 - Connecting.....14
 - Footswitch functions.....60
 - MIDI.....67
 - Feedback.....58
 - F-Folk.....29, 41, 42, 45, 46, 48, 49
 - F-Folk2.....41, 42, 45, 46, 48, 49
 - Fill.....61
 - Flanger.....56
 - Foot.....41, 48
 - Footswitches.....31, 60
- Free Bass**.....23
 - Edit.....48
 - MIDI TX.....50
 - Mode.....62
 - Panel functions.....12
- French**.....29, 42
- Full**.....18
- G**
- German.....29, 42
 - Growl.....46, 49
- H**
- Hall.....55
 - Headphones.....13, 14
 - High.....25, 49
 - HighLand.....25
 - Hold.....60
- I**
- Icon.....59
 - I-Folk.....41, 42, 45, 46, 48, 49
 - Initialize.....78
 - Intro.....61
 - Italian.....29, 42
- J**
- Jazz.....41, 42, 45, 46, 48, 49
 - Jump.....35
 - Just.....29
- K**
- Key.....28, 29
 - Keyboard icon.....24
 - Kirnberger.....29
- L**
- LCD Contrast.....60
 - Level.....30, 42
 - Button Noise.....49
 - Gowl.....46
 - Reverb.....56
 - Link.....42, 43
 - Low.....26, 49
 - Lowest Note.....51
- M**
- Macro.....55, 56, 58
 - Main page.....19
 - Master bar.....26
 - Master Bar Recall.....59
 - Master Tune.....38
 - Mean-Tone.....29
 - Memory Error.....80
 - Menu.....35, 36

MIDI		Treble	11
Channels	67, 69	Edit	40
Implementation	86	MIDI TX	44
Parts	72	Octave	42
Remote control	60	Orchestra	24
Sections	72	Panel functions	11
TX	44, 47, 50, 52, 54	Sust	60
Mode	25, 43	Using	20
Module	67	Trikitixa	41, 42, 45, 46, 48, 49
Musette Detune	28, 42	Tuning	29, 38
		Tuning system	38
N		Type	38, 41
Name	59, 63	Reed	45, 48
No Link	43		
Noise	42, 49	U	
Edit	30	User 1~3	29
North Eur	29, 42		
Note	72	V	
		Valve	30
O		Level	30
Octave	42, 53, 73	Noise	42
OldItaly	41, 42	Velocity	25, 74
Orc Bass		Velocity sensitivity	25
MIDI TX	52	Volume	20, 22, 30, 73
Release Time	52	Effects	21
Volume	27, 52	Orchestra	26, 30, 53
ORC.BASS	51	Orchestra Bass	27, 52
ORCH	24	Swells	31
EDIT	53		
Orch		W	
Bs Sust	60	Warning	80
On/Off	60	Werckmeister	29
Sust	60	Whole	49
Orchestra	24	Wrap	51
Bass	27	Write	77
Edit	53		
Link	43	Z	
MIDI TX	54	Zampogna	25
Mode	25		
Octave	53		
Volume	26, 53		
Orchestra Bass	51		
Organetto	41, 42, 45, 46, 48, 49		
Output	14		
P			
Pan	14		
Delay	56, 58		
Dlay	58		
Panel functions	11		
Panpot	73		
Parameter Access	60		
PBM	40		
Pedal Controller	60		
Personalizing	63		
PHONES	13		
Physical Behavior Modeling	40		
Pitch	28		
Plate	55		
Pre-Dly T	56		
Pre-LPF	56		
Pythagorean	29		
R			
RealTime RX-TX	69		
Recharging	32		
Recovering Data	80		
Reed			
Growl	46, 49		
Type	41, 45, 48		
Volume	42, 46, 49		
Register			
Bass	12, 46		
Footswitches	31		
Free Bass	49		
Treble	11, 41		
Release Time	52		
Resetting	78		
Resolution	71		
Restore SET	65		
Reverb	21, 64		
Macro Type	55		
MIDI	73		
Parameters	56		
Send	42, 47, 49, 52, 54		
Room	55		
Root note	29		
S			
Saving settings	77		
Scale	29, 38		
Assign	39		
Edit	38		
Scottish	29, 42		
Send	42, 47, 49, 52, 54		
Sequencer	67, 70		
Remarks	68		
Set	64		
Common	55		
Description	17		
Footswitches	31		
Name	59		
Program change	69		
Restore	65		
Selecting	21		
Solo	25		
Sordina	21		
Specifications	81		
Start/Stop	61		
Startup	63		
Name	63		
Status	41, 46, 49		
Std	26, 27, 30		
Steierische	41, 42, 45, 46, 48, 49		
Stereo			
Position	14		
Width	62		
Studio	41, 42, 45, 46, 48, 49		
Sustain	31, 60		
Switching on/off	15		
System	59		
T			
TexMex	41, 42		
Time	56		
TO FBC-7	13		
Tone Generator	67		
Touch	63		
Tradition	41, 42, 45, 46, 48, 49		
Transpose	28, 38		



This product complies with the requirements of European Directives EMC 89/336/EEC and LVD 73/23/EEC.

For EU Countries

FEDERAL COMMUNICATIONS COMMISSION RADIO FREQUENCY INTERFERENCE STATEMENT

For the USA

This equipment has been tested and found to comply with the limits for a Class B digital device, pursuant to Part 15 of the FCC Rules. These limits are designed to provide reasonable protection against harmful interference in a residential installation. This equipment generates, uses, and can radiate radio frequency energy and, if not installed and used in accordance with the instructions, may cause harmful interference to radio communications. However, there is no guarantee that interference will not occur in a particular installation. If this equipment does cause harmful interference to radio or television reception, which can be determined by turning the equipment off and on, the user is encouraged to try to correct the interference by one or more of the following measures:

- Reorient or relocate the receiving antenna.
- Increase the separation between the equipment and receiver.
- Connect the equipment into an outlet on a circuit different from that to which the receiver is connected.
- Consult the dealer or an experienced radio/TV technician for help.

This device complies with Part 15 of the FCC Rules. Operation is subject to the following two conditions:

- (1) This device may not cause harmful interference, and
- (2) This device must accept any interference received, including interference that may cause undesired operation.

Unauthorized changes or modification to this system can void the users authority to operate this equipment.
This equipment requires shielded interface cables in order to meet FCC class B Limit.

For Canada

NOTICE

This Class B digital apparatus meets all requirements of the Canadian Interference-Causing Equipment Regulations.

AVIS

Cet appareil numérique de la classe B respecte toutes les exigences du Règlement sur le matériel brouilleur du Canada.

Free Manuals Download Website

<http://myh66.com>

<http://usermanuals.us>

<http://www.somanuals.com>

<http://www.4manuals.cc>

<http://www.manual-lib.com>

<http://www.404manual.com>

<http://www.luxmanual.com>

<http://aubethermostatmanual.com>

Golf course search by state

<http://golfingnear.com>

Email search by domain

<http://emailbydomain.com>

Auto manuals search

<http://auto.somanuals.com>

TV manuals search

<http://tv.somanuals.com>