

PEDAL KEYBOARD PK-25A

Owner's Manual

Before using this unit, carefully read the sections entitled: "USING THE UNIT SAFELY" (p. 2, 3) and "Important Notes" (p. 4). These sections provide important information concerning the proper operation of the unit. Additionally, in order to feel assured that you have gained a good grasp of every feature provided by your new unit, this Owner's Manual should be read in its entirety. The manual should be saved and kept on hand as a convenient reference.

Thank you, and congratulations on your choice of the Roland PK-25A Pedal Keyboard. In addition to the pedal keyboard, which greatly enhances enjoyment in playing the organ, the PK-25A MIDI pedal keyboard unit also features an expression pedal that lends precise and dynamic volume expression to performances, a foot switch that enables pedal control over a variety of Roland VK-88/VK-8 combo organ functions, and a hold pedal for sustaining notes.

Features

- **Twenty five-note pedal keyboard and removable expression pedal**

The PK-25A features a twenty five-note pedal keyboard for maximum enjoyment of organ playing. The built-in expression pedal can be removed from the pedal keyboard unit to make the unit more compact for transportation.

- **Foot switches for controlling the VK-88/VK-8**

Two foot switches are built into the expression pedal. When the PK-25A is connected to a Roland VK-88 or VK-8 combo organ, you can then switch settings of the Roland VK-88 or VK-8 as you perform without removing your foot from the expression pedal or your hands from the keyboard.

- **Hold pedal**

A Hold pedal is provided. You can easily operate for additional expressive possibilities when playing sustain-type sounds.

- **Single-cable connection to the VK-88**

When connecting the PK-25A to the VK-88, the PK cable is the only connection required—no need for MIDI cables, analog cables, or an AC adaptor. This makes setup quick and easy.

- **Switching MIDI Channels and Octave Shift**

The PK-25A also features a MIDI channel switching knob that allows you to match the MIDI channel settings with other equipment when the PK-25A is connected to an external MIDI device other than a Roland combo organ (VK Series). Furthermore, you can use Octave Shift to change the pitch in octave increments.

Conventions used in this manual

Pages in this manual where you can find additional information are indicated like this: (p. **).



For the U.K.

IMPORTANT: THE WIRES IN THIS MAINS LEAD ARE COLOURED IN ACCORDANCE WITH THE FOLLOWING CODE.



BLUE: NEUTRAL
BROWN: LIVE

As the colours of the wires in the mains lead of this apparatus may not correspond with the coloured markings identifying the terminals in your plug, proceed as follows:
The wire which is coloured BLUE must be connected to the terminal which is marked with the letter N or coloured BLACK.
The wire which is coloured BROWN must be connected to the terminal which is marked with the letter L or coloured RED.
Under no circumstances must either of the above wires be connected to the earth terminal of a three pin plug.







USING THE UNIT SAFELY

INSTRUCTIONS FOR THE PREVENTION OF FIRE, ELECTRIC SHOCK, OR INJURY TO PERSONS

About  WARNING and  CAUTION Notices





 WARNING	Used for instructions intended to alert the user to the risk of death or severe injury should the unit be used improperly.
 CAUTION	Used for instructions intended to alert the user to the risk of injury or material damage should the unit be used improperly. * Material damage refers to damage or other adverse effects caused with respect to the home and all its furnishings, as well to domestic animals or pets.

About the Symbols





	The  symbol alerts the user to important instructions or warnings. The specific meaning of the symbol is determined by the design contained within the triangle. In the case of the symbol at left, it is used for general cautions, warnings, or alerts to danger.
	The  symbol alerts the user to items that must never be carried out (are forbidden). The specific thing that must not be done is indicated by the design contained within the circle. In the case of the symbol at left, it means that the unit must never be disassembled.
	The  symbol alerts the user to things that must be carried out. The specific thing that must be done is indicated by the design contained within the circle. In the case of the symbol at left, it means that the power-cord plug must be unplugged from the outlet.

ALWAYS OBSERVE THE FOLLOWING

WARNING

- Before using this unit, make sure to read the instructions below, and the Owner's Manual. 
- Do not open (or modify in any way) the unit or its AC adaptor. 
- Do not attempt to repair the unit, or replace parts within it (except when this manual provides specific instructions directing you to do so). Refer all servicing to your retailer, the nearest Roland Service Center, or an authorized Roland distributor, as listed on the "Information" page. 
- Never use or store the unit in places that are:
 - Subject to temperature extremes (e.g., direct sunlight in an enclosed vehicle, near a heating duct, on top of heat-generating equipment); or are 
 - Damp (e.g., baths, washrooms, on wet floors); or are 
 - Humid; or are
 - Exposed to rain; or are
 - Dusty; or are
 - Subject to high levels of vibration.

WARNING

- Make sure you always have the unit placed so it is level and sure to remain stable. Never place it on stands that could wobble, or on inclined surfaces. 
- Be sure to use only the AC adaptor supplied with the unit. Also, make sure the line voltage at the installation matches the input voltage specified on the AC adaptor's body. Other AC adaptors may use a different polarity, or be designed for a different voltage, so their use could result in damage, malfunction, or electric shock. 
- Do not excessively twist or bend the power cord, nor place heavy objects on it. Doing so can damage the cord, producing severed elements and short circuits. Damaged cords are fire and shock hazards! 
- Do not allow any objects (e.g., flammable material, coins, pins); or liquids of any kind (water, soft drinks, etc.) to penetrate the unit. 

⚠ WARNING

- Immediately turn the power off, remove the AC adaptor from the outlet, and request servicing by your retailer, the nearest Roland Service Center, or an authorized Roland distributor, as listed on the "Information" page when:
 - The AC adaptor or the power-supply cord has been damaged; or
 - If smoke or unusual odor occurs
 - Objects have fallen into, or liquid has been spilled onto the unit; or
 - The unit has been exposed to rain (or otherwise has become wet); or
 - The unit does not appear to operate normally or exhibits a marked change in performance.
- In households with small children, an adult should provide supervision until the child is capable of following all the rules essential for the safe operation of the unit.
- Protect the unit from strong impact. (Do not drop it!)
- Do not force the unit's power-supply cord to share an outlet with an unreasonable number of other devices. Be especially careful when using extension cords—the total power used by all devices you have connected to the extension cord's outlet must never exceed the power rating (watts/amperes) for the extension cord. Excessive loads can cause the insulation on the cord to heat up and eventually melt through.
- Before using the unit in a foreign country, consult with your retailer, the nearest Roland Service Center, or an authorized Roland distributor, as listed on the "Information" page.

⚠ CAUTION

- The unit and the AC adaptor should be located so their location or position does not interfere with their proper ventilation.
- Always grasp only the output plug or the body of the AC adaptor when plugging into, or unplugging from, this unit or an outlet.

⚠ CAUTION

- At regular intervals, you should unplug the AC adaptor and clean it by using a dry cloth to wipe all dust and other accumulations away from its prongs. Also, disconnect the power plug from the power outlet whenever the unit is to remain unused for an extended period of time. Any accumulation of dust between the power plug and the power outlet can result in poor insulation and lead to fire.
- Try to prevent cords and cables from becoming entangled. Also, all cords and cables should be placed so they are out of the reach of children.
- Never climb on top of, nor place heavy objects on the unit.
- Never handle the AC adaptor body, or its output plugs, with wet hands when plugging into, or unplugging from, an outlet or this unit.
- Before moving the unit, disconnect the AC adaptor and all cords coming from external devices.
- Before cleaning the unit, turn off the power and unplug the AC adaptor from the outlet (p. 7).
- Whenever you suspect the possibility of lightning in your area, disconnect the AC adaptor from the outlet.
- Keep the included knob bolts in a safe place out of children's reach, so there is no chance of them being swallowed accidentally.

Important Notes

In addition to the items listed under “USING THE UNIT SAFELY” on page 2 and 3, please read and observe the following:

Power Supply

- Do not connect this unit to same electrical outlet that is being used by an electrical appliance that is controlled by an inverter (such as a refrigerator, washing machine, microwave oven, or air conditioner), or that contains a motor. Depending on the way in which the electrical appliance is used, power supply noise may cause this unit to malfunction. If it is not practical to use a separate electrical outlet, connect a power supply noise filter between this unit and the electrical outlet.
- The AC adaptor will begin to generate heat after long hours of consecutive use. This is normal, and is not a cause for concern.
- Before connecting this unit to other devices, turn off the power to all units. This will help prevent malfunctions and/or damage to speakers or other devices.

Placement

- This device may interfere with radio and television reception. Do not use this device in the vicinity of such receivers.
- Noise may be produced if wireless communications devices, such as cell phones, are operated in the vicinity of this unit. Such noise could occur when receiving or initiating a call, or while conversing. Should you experience such problems, you should relocate such wireless devices so they are at a greater distance from this unit, or switch them off.
- Do not expose the unit to direct sunlight, place it near devices that radiate heat, leave it inside an enclosed vehicle, or otherwise subject it to temperature extremes. Also, do not allow lighting devices that normally are used while their light source is very close to the unit (such as a piano light), or powerful spotlights to shine upon the same area of the unit for extended periods of time. Excessive heat can deform or discolor the unit.
- When moved from one location to another where the temperature and/or humidity is very different, water droplets (condensation) may form inside the unit. Damage or malfunction may result if you attempt to use the unit in this condition. Therefore, before using the unit, you must allow it to stand for several hours, until the condensation has completely evaporated.
- Do not allow rubber, vinyl, or similar materials to remain on the unit for long periods of time. Such objects can discolor or otherwise harmfully affect the finish.
- Do not allow objects to remain on top of the keyboard or pedal board. This can be the cause of malfunction, such as keys ceasing to produce sound.
- Do not paste stickers, decals, or the like to this instrument. Peeling such matter off the instrument may damage the exterior finish.

- Depending on the material and temperature of the surface on which you place the unit, its rubber feet may discolor or mar the surface.
You can place a piece of felt or cloth under the rubber feet to prevent this from happening. If you do so, please make sure that the unit will not slip or move accidentally.

Maintenance

- To clean the unit, use a dry, soft cloth; or one that is slightly dampened. Try to wipe the entire surface using an equal amount of strength, moving the cloth along with the grain of the wood. Rubbing too hard in the same area can damage the finish.
- Never use benzine, thinners, alcohol or solvents of any kind, to avoid the possibility of discoloration and/or deformation.

Additional Precautions

- Use a reasonable amount of care when using the unit's buttons, sliders, or other controls; and when using its jacks and connectors. Rough handling can lead to malfunctions.
- When connecting / disconnecting all cables, grasp the connector itself—never pull on the cable. This way you will avoid causing shorts, or damage to the cable's internal elements.
- To avoid disturbing your neighbors, try to keep the unit's volume at reasonable levels (especially when it is late at night).
- When you need to transport the unit, package it in the box (including padding) that it came in, if possible. Otherwise, you will need to use equivalent packaging materials.



This product must be disposed of separately at your local waste recycling centre. Do not dispose of in household waste bin.

Index

USING THE UNIT SAFELY.....	2
Important Notes.....	4
Names and Functions	6
Connections	8
Attaching the Expression Pedal.....	8
Connecting to the VK-88.....	9
Connecting to the VK-8.....	10
Connecting to External MIDI Devices Other than the VK-88/VK-8....	11
Setting the MIDI Channel.....	12
Changing the Pitch (Octave Shift).....	12
Troubleshooting.....	13
Error Messages	13
Specifications	14
MIDI Implementation	15
MIDI Implementation Chart	16

Names and Functions

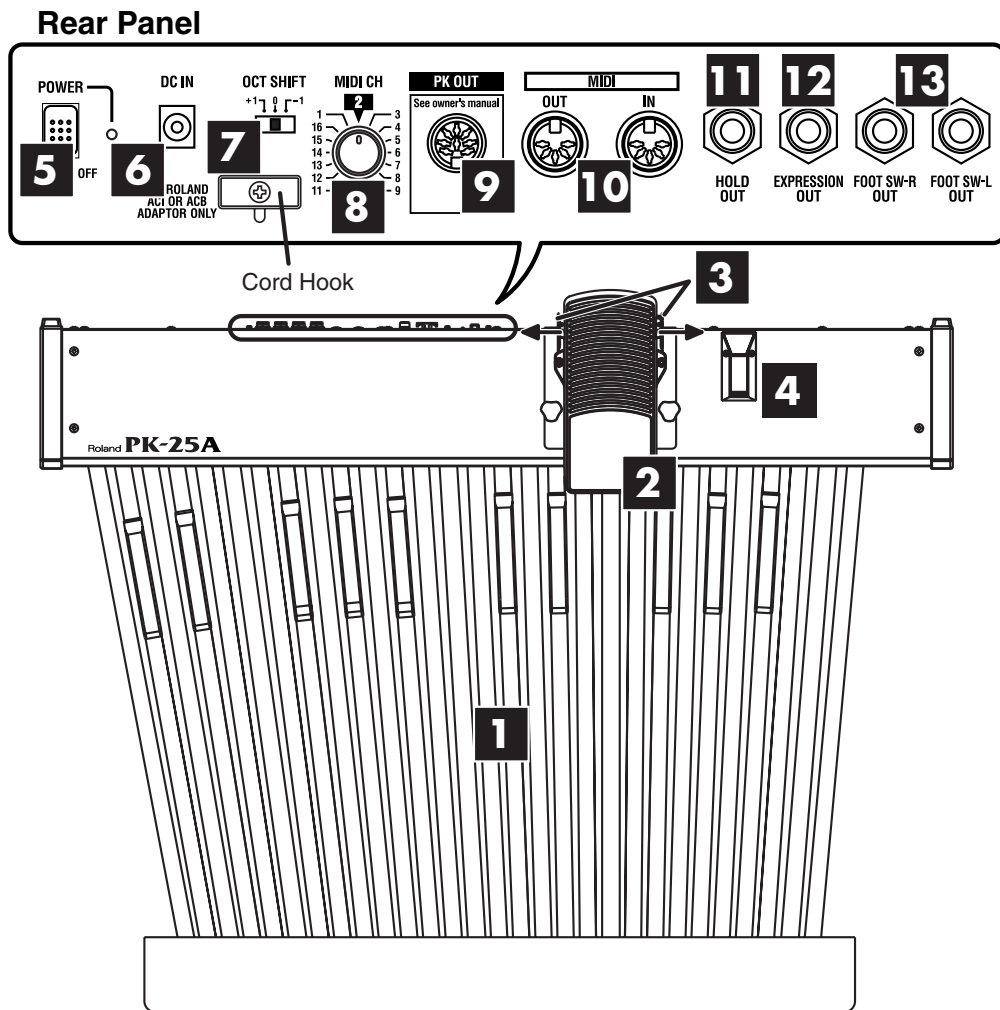

1. Pedal Keyboard

The PK-25A features a 25-note pedal keyboard that is ideal for organ performance.

2. Expression Pedal

Advancing the pedal will increase the volume, and returning the pedal toward yourself will decrease the volume. For instructions on connecting it, refer to page 8.

3. Foot Switches

Two foot switches are built on the sides of the expression pedal. You can control the connected devices by pressing the foot switch.



For more information on the foot switch functions when the PK-25A is connected to a VK-88 or VK-8, refer to "Connecting to the VK-88" (p. 9) or "Connecting to the VK-8" (p. 10).

4. Hold Pedal

Pressing down on the Hold pedal holds (sustains) the sound from the connected device.



For more information on the foot switch functions when the PK-25A is connected to a VK-88 or VK-8, refer to "Connecting to the VK-88" (p. 9) or "Connecting to the VK-8" (p. 10).

5. POWER Switch

This turns the power of the PK-25A on/off.



If the PK cable is used to connect the PK-25A to the VK-88, the PK-25A will turn on/off in tandem with the VK-88. The power switch of the PK-25A need not be switched on/off.

6. DC IN Jack

Connect the supplied AC adaptor to this jack.

To prevent the inadvertent disruption of power to your unit (should the plug be pulled out accidentally), and to avoid applying undue stress to the AC adaptor jack, anchor the power cord using the cord hook, as shown in the illustration.

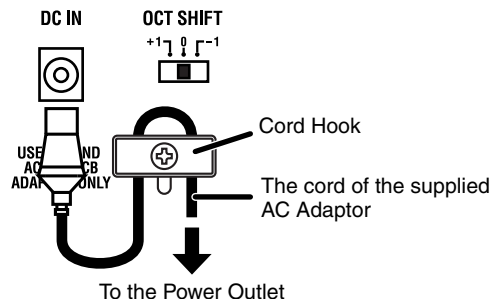

7. OCT SHIFT (Octave Shift) Switch

When the PK-25A is connected to an external MIDI device other than a VK-88 or VK-8, this switch allows you to transpose the pitch in octave units to match that of the connected device (p. 12).

8. MIDI CH (MIDI Channel Switching) Knob

This knob allows you to match the MIDI channel settings with other equipment when the PK-25A is connected to an external MIDI device other than a VK-88 or VK-8 (p. 12).

9. PK OUT Connector

Use the PK cable that is supplied with the VK-88 to connect this connector to the VK-88. After connecting to the VK-88, make sure to set the PEDAL KEYBOARD [SELECT] switch on the VK-88's rear panel to PK IN (VK-88 Owner's Manual, p. 22).

NOTE

Do not attempt to use any cable other than the PK cable, since this will cause malfunctions. This connector cannot be used with the VK-8.

10. MIDI Connectors

Connect a VK-8 or external MIDI device here.

Use a MIDI cable (sold separately) to make the connections.

11. HOLD OUT (Hold Pedal output) Jack

This jack outputs the on/off data from the hold pedal.

Use a monaural cable (phone-phone) (sold separately) to make the connections.

NOTE

If a cable is connected to this jack, Hold data will not be sent from the PK OUT connector or the MIDI OUT connector.

12. EXPRESSION OUT (Expression pedal output) Jack

This jack outputs the data from the expression pedal.

Use a stereo cable (phone-phone) (sold separately) to make the connections.

NOTE

The expression pedal is designed only for Roland/Boss products. Connecting it to products made by manufacturers other than Roland or Boss may cause malfunctions.

NOTE

If a cable is connected to this jack, Expression data will not be output from the PK OUT connector or MIDI OUT connector.

13. FOOT SW-L OUT/FOOT SW-R OUT (Foot switch L output /Foot switch R output) Jacks

These jacks output on/off data from the foot switches.

Use a monaural cable (phone-phone) (sold separately) to make the connections.

NOTE

If a cable is connected to these jacks, on/off data from the foot switches will not be output from the PK OUT connector or the MIDI OUT connector.

Attaching the Expression Pedal

The PK-25A is shipped with the expression pedal detached. Before connecting the PK-25A to another device, please attach the expression pedal.

NOTE

When attaching or detaching the expression pedal, be careful not to step on a knob bolt. When removing the knob bolts, place them out of the reach of children. If a knob bolt is accidentally swallowed, consult a doctor immediately.

To prevent malfunction and/or damage to speakers or other devices, always turn down the volume, and turn off the power on all devices before making any connections.

- 1. Connect the expression pedal cable to the connector in the upper part of the PK-25A.**

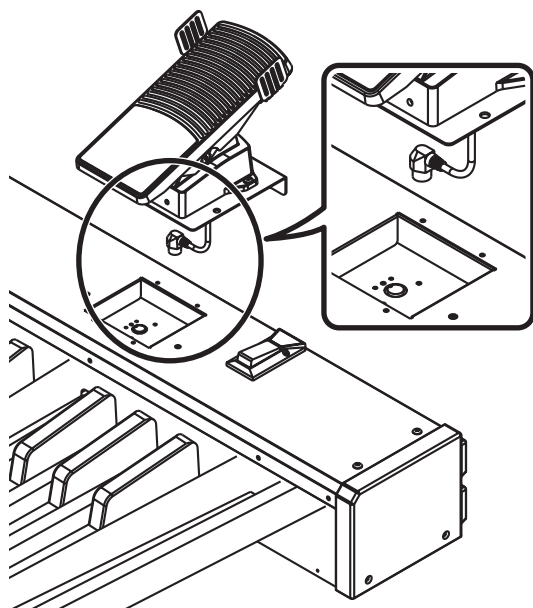

- 2. While being careful not to pinch the cable, place the expression pedal on the PK-25A.**

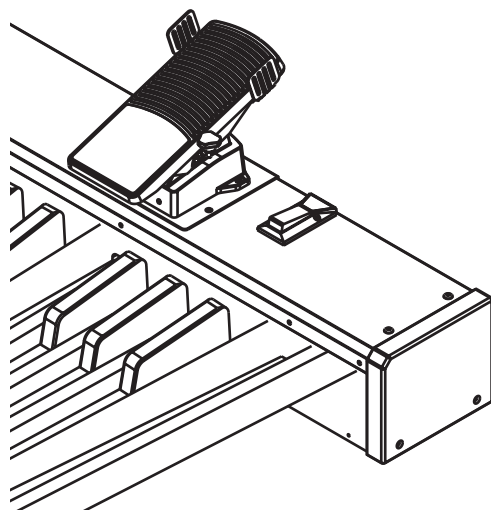

- 3. Use the three supplied knob bolts to fasten the expression pedal, making sure that the bolt holes are aligned.**

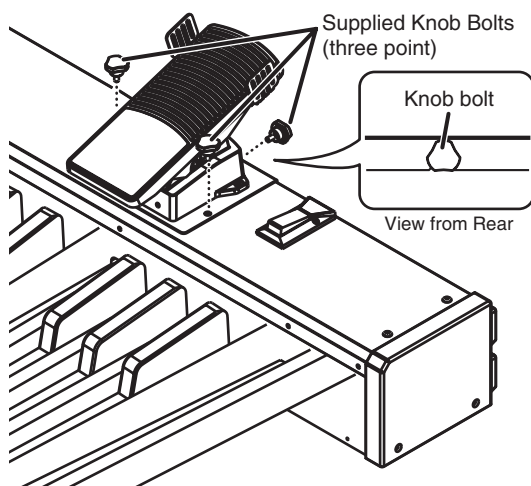

NOTE

The connector in the upper part of the PK-25A is only for connecting the supplied expression pedal. Connecting this to any device other than the PK-25A's own expression pedal could result in malfunction.

Connecting to the VK-88

Use the PK cable that is supplied with the VK-88 to connect the VK-88 and PK-25A.



The supplied AC adaptor is not used. The PK-25A will be turned on/off by the power switch of the VK-88, regardless of the position of the PK-25A's own power switch.

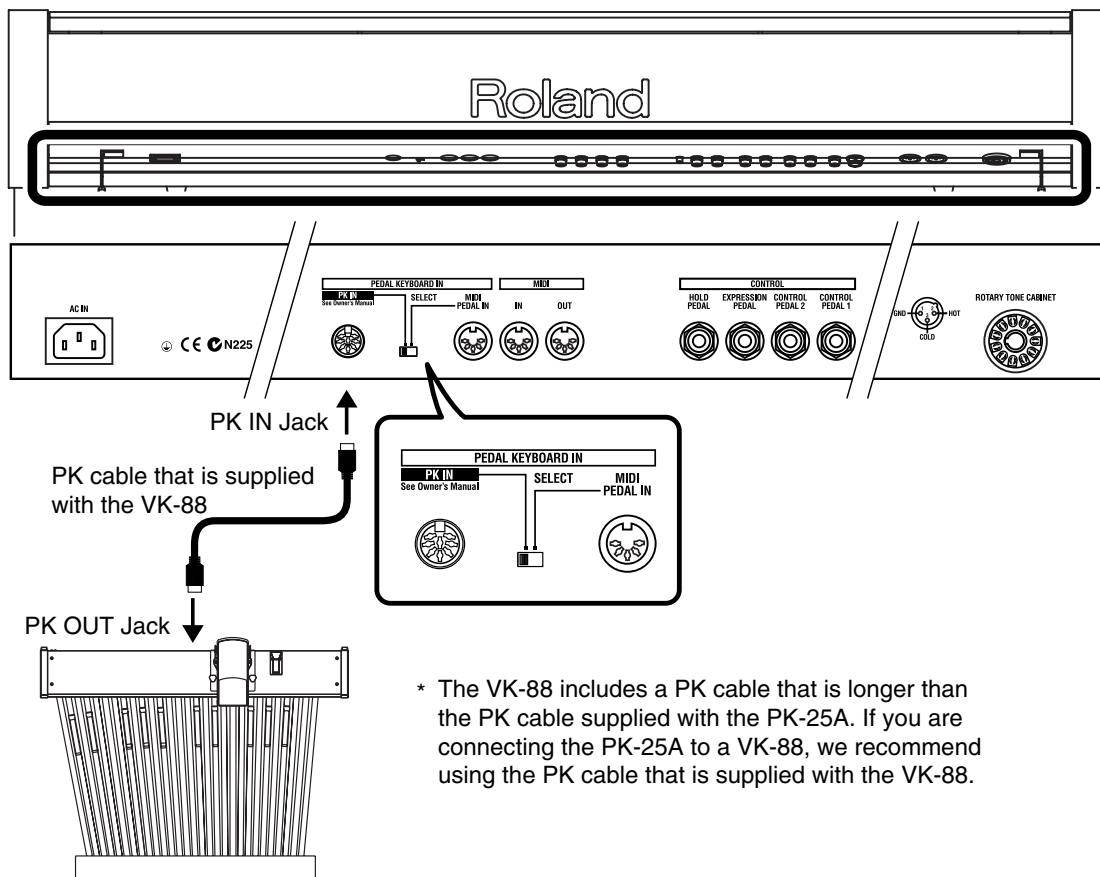

1. Make sure that the VK-88's power is turned off.
2. Set the PEDAL KEYBOARD [SELECT] switch (located on the rear panel of the VK-88) to the PK IN position.
3. Use the PK cable that is supplied with the VK-88 to connect the VK-88's PK IN connector to the PK-25A's PK OUT connector.



Once the connections have been completed, turn on power to your various devices in the order specified. By turning on devices in the wrong order, you risk causing malfunction and/or damage to speakers and other devices.

4. As explained on the VK-88 Owner's Manual, turn on the power of the VK-88.
5. Make sure that the indicator on the rear panel of the PK-25A is lit.
6. Play the pedal keyboard. If you hear the pedal part of the VK-88, connections are complete.



This unit is equipped with a protection circuit. A brief interval (a few seconds) after power up is required before the unit will operate normally.



If connecting the PK-25A to a VK-88, set the OCT SHIFT (Octave Shift) switch to the "0" position.



You can select the part that will be sustained when you press the Hold pedal.

→ HOLD PEDAL ASSIGN (VK-88 Owner's Manual, p. 80)



A variety of functions can be assigned to each foot switch (L/R).

→ PK FOOT L ASSIGN (VK-88 Owner's Manual, p. 68)

→ PK FOOT R ASSIGN (VK-88 Owner's Manual, p. 68)

Connecting to the VK-8

Use a MIDI cable to connect the VK-8 and PK-25A.

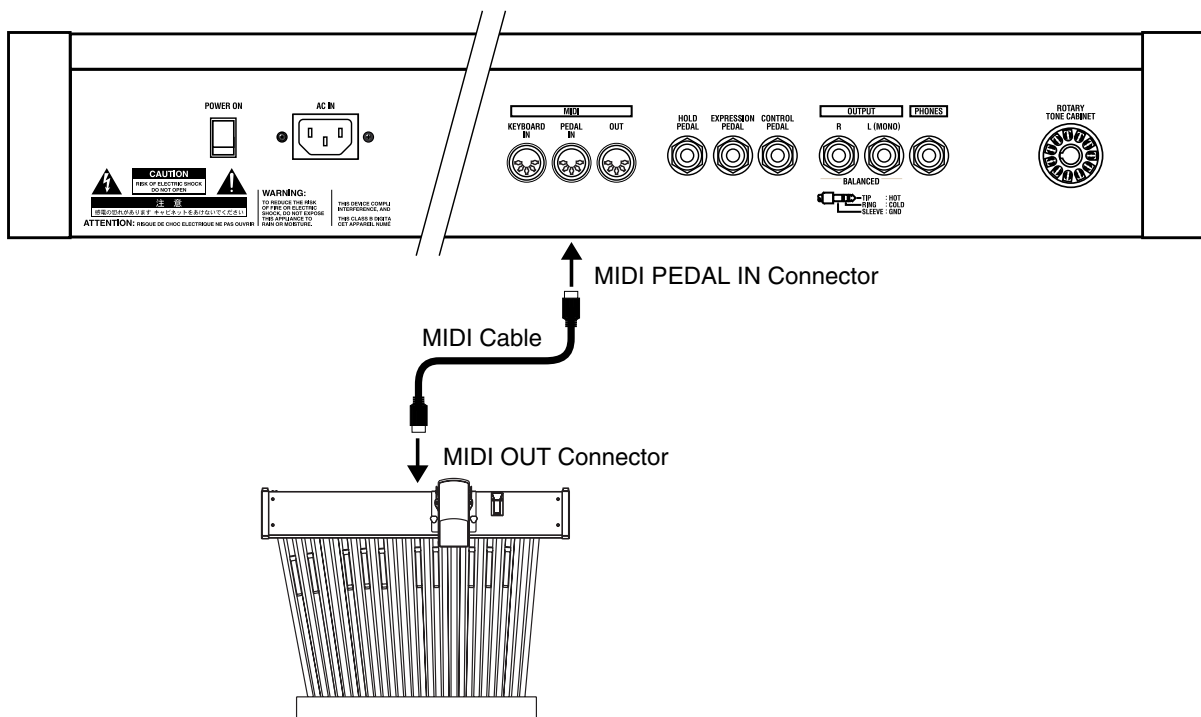

- 1.** Make sure that the power of the VK-8 and PK-25A is turned off.
- 2.** Use a MIDI cable to connect the VK-8's MIDI PEDAL IN connector to the PK-25A's MIDI OUT connector.
- 3.** Connect the appropriate end of the AC adaptor to the DC IN jack. Then connect the other end to a standard AC outlet.

NOTE

Once the connections have been completed, turn on power to your various devices in the order specified. By turning on devices in the wrong order, you risk causing malfunction and/or damage to speakers and other devices.

- 4.** Turn on the power of the PK-25A, and make sure that the indicator on the PK-25A's rear panel is lit.
- 5.** As described in the VK-8 Owner's Manual, turn on the power of the VK-8.
- 6.** Make sure that the Sub-Keyboard Function is on (VK-8 Owner's Manual p. 58).

7. Play the pedal keyboard. If the pedal part is heard from the VK-8, connections are complete.



This unit is equipped with a protection circuit. A brief interval (a few seconds) after power up is required before the unit will operate normally.

Once you have made connections as described above, you can use the switches and pedals to control the following functions.

- Expression pedal: Control the volume of all parts of the Organ, and the Other Tones.
- Foot switch L: Switch the rotary effect between slow/fast.
- Foot switch R: Turn the rotary effect brake on/off.
- Hold pedal: Hold (sustain) the sound of the Organ voice and Other Tones.



If connecting the PK-25A to a VK-8, set the OCT SHIFT (Octave Shift) switch to the "0" position.



When the PK-25A's FOOT SW-L OUT/FOOT SW-R OUT/HOLD OUT jack is connected to the VK-8's CONTROL PEDAL jack, you can assign a variety of functions to the foot switch. Use a mono cable (phone-phone) to make connections.

→ Assigning a Function to the Control Pedal (VK-8 Owner's Manual, p. 40)



When the PK-25A's EXPRESSION OUT jack is connected to the VK-8's EXPRESSION PEDAL jack, you can use the expression pedal to simultaneously control the volume of all parts of the Organ and the Other Tones. Use a stereo cable (phone-phone) to make connections.

→ Using the Expression Pedal (VK-8 Owner's Manual, p. 39)



When the PK-25A's HOLD OUT jack is connected to the VK-8's HOLD PEDAL jack, you can play can sustain the sound by pressing the pedal. Use a monaural cable (phone-phone) to make connections.

→ Using the Hold Pedal to Sustain the Sound (VK-8 Owner's Manual, p. 42)



The PK-25A provides a "MIDI Merge" feature, which allows you to have the MIDI messages received at MIDI IN be combined with the MIDI messages produced by playing the PK-25A itself. The resulting merged data stream is then transmitted from the MIDI OUT connector.



Turn off the power of the PK-25A after turning off the power of VK-8.

Connecting to External MIDI Devices Other than the VK-88/VK-8

Use a MIDI cable to connect external MIDI devices to the PK-25A.



The PK-25A provides a "MIDI Merge" feature, which allows you to have the MIDI messages received at MIDI IN be combined with the MIDI messages produced by playing the PK-25A itself. The resulting merged data stream is then transmitted from the MIDI OUT connector.

1. Make sure that the power of the external device and PK-25A is turned off.
2. Use a MIDI cable to connect the external device's MIDI IN connector to the PK-25A's MIDI OUT connector.



If necessary, connect the FOOT SW-L OUT, FOOT SW-R OUT, and/or HOLD OUT jacks to the corresponding connectors on the external MIDI device.

NOTE

Once the connections have been completed, turn on power to your various devices in the order specified. By turning on devices in the wrong order, you risk causing malfunction and/or damage to speakers and other devices.

- 3. Turn on the power of the PK-25A, and make sure that the indicator on the PK-25A's rear panel is lit.**
- 4. Turn on the power to the external MIDI device according to the instructions in the owner's manual for the device.**
- 5. Set the PK-25A's MIDI channel.**
→ "Setting the MIDI Channel" (Next section)
- 6. Set the MIDI channel on the external MIDI device to match the channel set for the PK-25A.**
- 7. Play the pedal keyboard. If the pedal part is heard from the VK-8, connections are complete.**

NOTE

Turn off the power of the PK-25A after turning off the power of the external MIDI device.

Setting the MIDI Channel

When connecting the PK-25A to external MIDI devices other than the VK-88 or VK-8, set the PK-25A's MIDI channel and the MIDI channel on the external MIDI device to the same channel.

- 1. Turn the MIDI CH (MIDI Channel Switching) knob on the PK-25A's rear panel to switch the MIDI channel.**



Setting the MIDI channel is unnecessary when the PK-25A is connected to a VK-88 or VK-8.

Changing the Pitch (Octave Shift)

You can change the pitch in octave increments, allowing you to match the pitch to that of the connected device.

- 1. Switch the Octave Shift setting with the OCT SHIFT (Octave Shift) switch on the PK-25A's rear panel.**

Set the switch to the "+1" position to raise the pitch one octave or to the "-1" position to lower the pitch one octave.



If connecting the PK-25A to a VK-88 or VK-8, set the OCT SHIFT (Octave Shift) switch to the "0" position.

Troubleshooting

If the PK-25A does not function as you expect, please check the following points first. If this does not resolve the problem, contact your dealer or a nearby Roland service center.

- The power (indicator) does not come on when I turn on the power switch.
 - ◆ If the PK-25A is connected to a device that cannot use the PK cable (such as the VK-8), the supplied AC adaptor must be used. After connecting the AC adaptor correctly, turn the power switch on.
- The power (indicator) does not turn on/off when I turn the PK-25A's power switch on/off.
 - ◆ The PK-25A's power is switched on/off in tandem with the VK-88 when it is connected to the VK-88 using the PK cable that is supplied with the VK-88. Make sure that the VK-88's power is turned on and the PK cable is connected correctly.
- The foot switch, hold pedal, and/or expression pedal do not operate correctly.
 - ◆ Make sure that the expression pedal cable is correctly connected to the connector on the upper part of the PK-25A (p. 7).
 - ◆ If the PK cable is used to connect the PK-25A to the VK-88
 - Make sure that the cable is connected correctly (p. 7).
 - Check the settings of the switches or pedals.
Foot switch: VK-88 Owner's Manual, p. 68 (PK FOOT L ASSIGN/PK FOOT R ASSIGN)
Hold pedal: VK-88 Owner's Manual, p. 80 (HOLD PEDAL ASSIGN)
Expression pedal: VK-88 Owner's Manual, p. 82 (ORCHESTRAL TONES EXPRESSION)
 - ◆ If a MIDI cable is used to connect the PK-25A to the VK-88
 - Check that the MIDI cable is connected correctly (p. 8).
 - If you wish to use the expression pedal to control the volume of the Other Tones, use a stereo cable (phone-phone) to connect the PK-25A's EXPRESSION OUT jack to the VK-8's EXPRESSION PEDAL jack, or the PK-25A's EXPRESSION OUT jack to the VK-8's CONTROL PEDAL jack. (VK-8 Owner's Manual, p. 40-41)
- ◆ If MIDI and analog cables are used to connect the PK-25A to the VK-8
 - Make sure that the polarity of the VK-8's CONTROL PEDAL jack is set to "Standard." (VK-8 Owner's Manual, p. 56)
 - Make sure that a function is assigned to the VK-8's CONTROL PEDAL jack. (VK-8 Owner's Manual, p. 40-41)
 - Use a stereo cable (phone-phone) when connecting the PK-25A's EXPRESSION OUT jack to the VK-8's EXPRESSION PEDAL jack, or the PK-25A's EXPRESSION OUT jack to the VK-8's CONTROL PEDAL jack.
- Cannot assign a function to the foot switch.
 - ◆ When the PK-25A is connected to the VK-8 without using analog cables, functions other than Rotary Slow/Fast (foot pedal L) and Rotary Brake (foot pedal R) cannot be assigned.
- No sound plays.
 - ◆ When connecting to any external MIDI device other than the VK-88 or VK-8, you must match the PK-25A's MIDI channel to the MIDI channel set for the connected device.
 - ◆ If connecting the PK-25A to a VK-8, switch the Sub-Keyboard Function to ON. (VK-8 Owner's Manual, p. 56)
- Sounds are not playing correctly.
 - ◆ Confirm whether or not the Octave Shift switch is set correctly. If the PK-25A is connected to a VK-88 or VK-8, set the Octave Shift switch to the "0" position.

Error Messages

In the following situations, the indicator of the rear panel of PK-25A will blink for several seconds.

Situation 1: It is possible that the MIDI cable has been disconnected or is damaged.

Action 1: Check the MIDI cable connections.

Situation 1: MIDI data could not be received correctly.

Action 1: If the indicator continues blinking for an extended period of time, there is a problem with the content of the MIDI data.

Specifications

- Pedalboard: 25 keys
- Control: Expression Pedal
Foot Switch (L, R)
Damper (Hold) Switch
MIDI CH (MIDI Channel Switching) Knob
OCT SHIFT (Octave Shift) Switch
Power Switch
 - Connectors: PK OUT Jack
MIDI Connectors (IN, OUT)
HOLD OUT Jack
EXPRESSION OUT Jack
FOOT SW-R OUT Jack
FOOT SW-L OUT Jack
DC IN Jack
 - Power: DC 9 V: AC adaptor, or supplied from VK-88 via PK cable
 - Current Draw: 120 mA (DC 9 V)
 - Dimensions: 1068 (W) x 885 (D) x 283 (H) mm
42-1/16 (W) x 34-7/8 (D) x 11-3/16 (H) inches
 - Weight: 29.0 kg / 63 lbs 15 oz
 - Accessories: Owner's Manual
AC Adaptor
PK cable
 - Options: MIDI Cable, Analog Cable (Stereo, Monaural)
- * In the interest of product improvement, the specifications and/or appearance of this unit are subject to change without prior notice.

MIDI Implementation

Model: PK-25A (MIDI Pedal Keyboard)
Date: Oct. 20, 2005
Version: 1.00

1. Recognized Receive Data

■System Realtime Messages

Status
FEH

* By receiving an Active Sensing message, this unit enters the mode timing the interval between incoming MIDI messages. If the interval exceeds 500 ms, this unit transmits Note Off messages corresponding to the transmitted notes being On, and returns from this mode.

2. Transmitted Data

■Channel Voice Messages

●Note off

<u>Status</u>	<u>2nd byte</u>	<u>3rd byte</u>
8nH	kkH	40H

n = MIDI channel: 0H - FH (ch.1 - 16)
kk = note number: 18H - 48H (24 - 72)

●Note on

<u>Status</u>	<u>2nd byte</u>	<u>3rd byte</u>
9nH	kkH	78H

n = MIDI channel: 0H - FH (ch.1 - 16)
kk = note number: 18H - 48H (24 - 72)

●Control Change

○Expression (Controller number 11)

<u>Status</u>	<u>2nd byte</u>	<u>3rd byte</u>
BnH	0BH	vvH

n = MIDI channel: 0H - FH (ch.1 - 16)
vv = expression: 00H - 7FH (0 - 127)

* If the EXPRESSION OUT jack on the rear panel is in use, this unit doesn't send Expression message via MIDI.

○General Purpose Controller 3 (Controller number 18)

<u>Status</u>	<u>2nd byte</u>	<u>3rd byte</u>
BnH	12H	vvH

n = MIDI channel: 0H - FH (ch.1 - 16)
vv = control value: 00H, 7FH (0, 127)

* This message will be sent by operating a foot switch locating left side of the expression pedal.

* If a FOOT SW-L OUT jack on the rear panel is in use, the unit doesn't send this message via MIDI.

○General Purpose Controller 4 (Controller number 19)

<u>Status</u>	<u>2nd byte</u>	<u>3rd byte</u>
BnH	13H	vvH

n = MIDI channel: 0H - FH (ch.1 - 16)
vv = control value: 00H, 7FH (0, 127)

* This message will be sent by operating a foot switch locating right side of the expression pedal.

* If a FOOT SW-R OUT jack on the rear panel is in use, the unit doesn't send this message via MIDI.

○Hold 1 (Controller number 64)

<u>Status</u>	<u>2nd byte</u>	<u>3rd byte</u>
BnH	40H	vvH

n = MIDI channel: 0H - FH (ch.1 - 16)
vv = control value: 00H, 7FH (0, 127)

* If a HOLD OUT jack on the rear panel is in use, the unit doesn't send Hold 1 message via MIDI.

■System Realtime Message

●Active sensing

Status
FEH

* This will be transmitted constantly at intervals of approximately 250 ms.

■System Exclusive Messages

"Data Set 1 (DT1)" to control VK-8/7 is the only System Exclusive messages transmitted by PK-25A.

●Data Set1 DT1

<u>Status</u>	<u>Data byte</u>	<u>Status</u>
F0H	41H, 10H, 00H, 08H, 12H, aaH, bbH, ccH, ddH, eeH, sum	F7H

<u>Byte</u>	<u>Remarks</u>
F0H	Exclusive status
41H	ID number (Roland)
10H	device ID
00H	model ID
08H	model ID (VK-7)
12H	command ID (DT1)
aaH	address MSB: The most significant byte of the address
bbH	address
ccH	address
ddH	address LSB: The least significant byte of the address
eeH	data: The actual data to be transmitted.
sum	checksum
F7H	EOX (End Of Exclusive)

* This unit sends the following messages to control ROTARY SOUND of the VK-8/7.

F0 41 10 00 08 12 02 00 10 3D ... F7
(Rotary Speed: Transmit by FOOT SW-L)

F0 41 10 00 08 12 02 00 10 3E ... F7
(Rotary Rotation: Transmit by FOOT SW-R)

MIDI Implementation Chart

Function...		Transmitted	Recognized	Remarks
Basic Channel	Default Changed	1 – 16 1 – 16	x x	
Mode	Default Messages Altered	Mode 3 x *****	x x	
Note Number :	True Voice	24 – 72 *****	x x	
Velocity	Note ON Note OFF	O (9n, v=120) O (8n, v=64)	x x	
After Touch	Key's Ch's	x x	x x	
Pitch Bend		x	x	
Control Change	11 18 19 64	O O O O	x x x x	Expression General Purpose 3 General Purpose 4 Hold 1
Prog Change	: True #	x *****	x x	
System Exclusive		O *1	x	
System Common	SongPos SongSel Tune	x x x	x x x	
System Real Time	Clock Commands	x x	x x	
Aux Message	All Sound OFF Reset All Controllers Local ON/OFF All Notes OFF Active Sensing Reset	x x x x O x	x x x x O x	
Notes	*1 For controlling Rotary Sound of the VK-8/7			

Mode 1 : OMNI ON, POLY Mode 2 : OMNI ON, MONO O : Yes
 Mode 3 : OMNI OFF, POLY Mode 4 : OMNI OFF, MONO x : No

Information

When you need repair service, call your nearest Roland Service Center or authorized Roland distributor in your country as shown below.

AFRICA

EGYPT

Al Fanny Trading Office
9, EBN Hagar A1 Askalany Street,
ARD E1 Golf, Heliopolis,
Cairo 11341, EGYPT
TEL: 20-2-417-1828

REUNION

Maison FO - YAM Marcel
25 Rue Jules Hermann,
Chaudron - BP79 97 491
Ste Clotilde Cedex,
REUNION ISLAND
TEL: (0262) 218-429

SOUTH AFRICA

That Other Music Shop(PTY)Ltd.
11 Melle St., Braamfontein,
Johannesbourg,
SOUTH AFRICA
TEL: (011) 403 4105
FAX: (011) 403 1234

Paul Bothner(PTY)Ltd.

Royal Cape Park, Unit 24
Londonderry Road, Ottery 7800
Cape Town, SOUTH AFRICA
TEL: (021) 799 4900

ASIA

CHINA

Roland Shanghai Electronics Co.,Ltd.
5F. No.1500 Pingliang Road
Shanghai 200090, CHINA
TEL: (021) 5580-0800

Roland Shanghai Electronics Co.,Ltd.

(BEIJING OFFICE)
10F. No.18 3 Section Anhuaxili
Chaoyang District Beijing
100011 CHINA
TEL: (010) 6426-5050

Roland Shanghai Electronics Co.,Ltd.

(GUANGZHOU OFFICE)
2/F., No.30 Si You Nan Er Jie
Yi Xiang, Wu Yang Xin Cheng,
Guangzhou 510600, CHINA
TEL: (020) 8736-0428

HONG KONG

Tom Lee Music Co., Ltd.
Service Division
22-32 Pun Shan Street, Tsuen
Wan, New Territories,
HONG KONG
TEL: 2415 0911

Parsons Music Ltd.

8th Floor, Railway Plaza, 39
Chatham Road South, T.S.T,
Kowloon, HONG KONG
TEL: 2333 1863

INDIA

Rivera Digitec (India) Pvt. Ltd.
409, Nirman Kendra
Mahalaxmi Flats Compound
Off. Dr. Edwin Moses Road,
Mumbai-400011, INDIA
TEL: (022) 2493 9051

INDONESIA

PT Citra IntiRama
Jl. Cideng Timur No. 15J-150
Jakarta Pusat
INDONESIA
TEL: (021) 6324170

KOREA

Cosmos Corporation
1461-9, Seocho-Dong,
Seocho Ku, Seoul, KOREA
TEL: (02) 3486-8855

MALAYSIA

Roland Asia Pacific Sdn. Bhd.
45-1, Block C2, Jalan PJU 1/39,
Dataran Prima, 47301 Petaling
Jaya, Selangor, MALAYSIA
TEL: (03) 7805-3263

PHILIPPINES

G.A. Yupango & Co. Inc.
339 Gil J. Puyat Avenue
Makati, Metro Manila 1200,
PHILIPPINES
TEL: (02) 899 9801

SINGAPORE

SWEET LEE MUSIC COMPANY PTE. LTD.
150 Sims Drive,
SINGAPORE 387381
TEL: 6846-3676

TAIWAN

ROLAND TAIWAN ENTERPRISE CO., LTD.
Room 5, 9fl. No. 112 Chung
Shan N.Road Sec.2, Taipei,
TAIWAN, R.O.C.
TEL: (02) 2561 3339

THAILAND

Theera Music Co., Ltd.
330 Soi Verng NakornKasem,
New Road, Sumpantawongse,
Bangkok 10100, THAILAND
TEL: (02) 224-8821

VIETNAM

SAIGON MUSIC DISTRIBUTOR (TAN DINH MUSIC)
138 Tran Quang Khai Street
Dist. 1, Ho Chi Minh City
VIETNAM
TEL: (08) 848-4068

AUSTRALIA/NEW ZEALAND

AUSTRALIA/NEW ZEALAND

Roland Corporation Australia Pty.,Ltd.
38 Campbell Avenue
Dee Why West. NSW 2099
AUSTRALIA

For Australia
Tel: (02) 9982 8266
For New Zealand
Tel: (09) 3098 715

CENTRAL/LATIN AMERICA

ARGENTINA

Instrumentos Musicales S.A.
Av.Santa Fe 2055
(1123) Buenos Aires
ARGENTINA
TEL: (011) 4508-2700

BARBADOS

A&B Music Supplies LTD
12 Webster Industrial Park
Wildely, St.Michael, Barbados
TEL: (246)430-1100

BRAZIL

Roland Brasil Ltda.
Rua San Jose, 780 Sala B
Parque Industrial San Jose
Cotia - Sao Paulo - SP, BRAZIL
TEL: (011) 4615 5666

CHILE

Comercial Fancy II S.A.
Rut.: 96.919.420-1
Nataaniel Cox #739, 4th Floor
Santiago - Centro, CHILE
TEL: (02) 688-9540

COLOMBIA

Centro Musical Ltda.
Cra 43 B No 25 A 41 Bododega 9
Medellin, Colombia
TEL: (574)3812529

COSTA RICA

JUAN Bansbach Instrumentos Musicales
Ave.1. Calle 11, Apartado 10237,
San Jose, COSTA RICA
TEL: 258-0211

CURACAO

Zeelandia Music Center Inc.
Orionweg 30
Curacao, Netherland Antilles
TEL:(305)5926866

DOMINICAN REPUBLIC

Instrumentos Fernando Giraldez
Calle Proyecto Central No.3
Ens.La Esperilla
Santo Domingo,
Dominican Republic
TEL:(809) 683 0305

ECUADOR

Mas Musica
Rumichaca 822 y Zaruma
Guayaquil - Ecuador
TEL:(593-4)2302364

EL SALVADOR

OMNI MUSIC
75 Avenida Norte y Final
Alameda Juan Pablo II,
Edificio No.4010 San Salvador,
EL SALVADOR
TEL: 262-0788

GUATEMALA

Casa Instrumental
Calzada Roosevelt 34-01,zona 11
Ciudad de Guatemala
Guatemala
TEL:(502) 599-2888

HONDURAS

Almacen Pajaro Azul S.A. de C.V.
BO.Paz Barahona
3 Ave.11 Calle S.O
San Pedro Sula, Honduras
TEL: (504) 553-2029

MARTINIQUE

Musique & Son
Z.I.Les Mangle
97232 Le Lamantin
Martinique F.W.I.
TEL: 596 596 426860

Gigamus SARL

10 Rte De La Folie
97200 Fort De France
Martinique F.W.I.
TEL: 596 596 715222

MEXICO

Casa Veerkamp, s.a. de c.v.
Av. Toluca No. 323, Col. Olivar
de los Padres 01780 Mexico
D.F. MEXICO
TEL: (55) 5668-6699

NICARAGUA

Bansbach Instrumentos Musicales Nicaragua
Altamira D'Este Calle Principal
de la Farmacia 5ta.Avenida
1 Cuadra al Lago.#503
Managua, Nicaragua
TEL: (505)277-2557

PANAMA

SUPRO MUNDIAL, S.A.
Boulevard Andrews, Albrook,
Panama City, REP. DE
PANAMA
TEL: 315-0101

PARAGUAY

Distribuidora De Instrumentos Musicales
J.E. Olear y ESQ. Manduvira
Asuncion PARAGUAY
TEL: (595) 21 492147

PERU

Audionet
Distribuciones Musicales SAC
Juan Fanning 530
Miraflores
Lima - Peru
TEL: (511) 4461388

TRINIDAD

AMR Ltd
Ground Floor
Maritime Plaza
Barataria Trinidad W.L.
TEL: (868) 638 6385

URUGUAY

Todo Musica S.A.
Francisco Acuna de Figueroa
1771
C.P.: 11.800
Montevideo, URUGUAY
TEL: (02) 924-2335

VENEZUELA

Instrumentos Musicales Allegro,C.A.
Av.las industrias edf.Guitar
import
#7 zona Industrial de Turumo
Caracas, Venezuela
TEL: (212) 244-1122

EUROPE

AUSTRIA

Roland Elektronische Musikinstrumente HmbH.
Austrian Office
Eduard-Bodem-Gasse 8,
A-6020 Innsbruck, AUSTRIA
TEL: (0512) 26 44 260

BELGIUM/FRANCE/

HOLLAND/

LUXEMBOURG

Roland Central Europe N.V.
Houtstraat 3, B-2260, Oevel
(Westerlo) BELGIUM
TEL: (014) 575811

CZECH REP.

K-AUDIO
Kardasovska 626,
CZ-198 00 Praha 9,
CZECH REP.
TEL: (2) 666 10529

DENMARK

Roland Scandinavia A/S
Nordhavnsvej 7, Postbox 880,
DK-2100 Copenhagen
DENMARK
TEL: 3916 6200

FINLAND

Roland Scandinavia As, Filial Finland
Elannontie 5
FIN-01510 Vantaa, FINLAND
TEL: (09) 68 24 020

GERMANY

Roland Elektronische Musikinstrumente HmbH.
Oststrasse 96, 22844
Norderstedt, GERMANY
TEL: (040) 52 60090

GREECE

STOLLAS S.A.
Music Sound Light
155, New National Road
Patras 26442, GREECE
TEL: 2610 435400

HUNGARY

Roland East Europe Ltd.
Warehouse Area 'DEPO' Pf.83
H-2046 Torokbalint,
HUNGARY
TEL: (23) 511011

IRELAND

Roland Ireland
G2 Calmount Park, Calmount
Avenue, Dublin 12
Republic of IRELAND
TEL: (01) 4294444

ITALY

Roland Italy S. p. A.
Viale delle Industrie 8,
20020 Arese, Milano, ITALY
TEL: (02) 937-78300

NORWAY

Roland Scandinavia Advd.
Kontor Norge
Lilleakerveien 2 Postboks 95
Lilleaker N-0216 Oslo
NORWAY
TEL: 2273 0074

POLAND

MX MUSIC SP.Z.O.O.
UL. Gibraltarska 4,
PL-03664 Warszawa POLAND
TEL: (022) 679 44 19

PORTUGAL

Roland Iberia, S.L.
Portugal Office
Cais das Pedras, 8/9-1 Dto
4050-465, Porto, PORTUGAL
TEL: 22 608 00 60

ROMANIA

FBS LINES
Piata Libertatii 1,
535500 Cheorgheni,
ROMANIA
TEL: (266) 364 609

RUSSIA

MuTek
Dorozhnaya ul.3,korp.6
117 545 Moscow, RUSSIA
TEL: (095) 981-4967

SPAIN

Roland Iberia, S.L.
Paseo Garcia Faria, 33-35
08005 Barcelona SPAIN
TEL: 93 493 91 00

SWEDEN

Roland Scandinavia A/S
SWEDISH SALES OFFICE
Danvik Center 28, 2 tr.
S-131 30 Nacka SWEDEN
TEL: (08) 702 00 20

SWITZERLAND

Roland (Switzerland) AG
Landstrasse 5, Postfach,
CH-4452 Ittingen,
SWITZERLAND
TEL: (061) 927-8383

UKRAINE

TIC-TAC
Mira Str. 19/108
P.O. Box 180
295400 Munkachevo,
UKRAINE
TEL: (03131) 414-40

UNITED KINGDOM

Roland (U.K.) Ltd.
Atlantic Close, Swansea
Enterprise Park, SWANSEA
SA7 9FJ,
UNITED KINGDOM
TEL: (01792) 702701

MIDDLE EAST

BAHRAIN

Moon Stores
No.16, Bab Al Bahrain Avenue,
P.O.Box 247, Manama 304,
State of BAHRAIN
TEL: 17 211 005

CYPRUS

Radex Sound Equipment Ltd.
17, Diagorou Street, Nicosia,
CYPRUS
TEL: (022) 66-9426

IRAN

MOCO INC.
No.41 Nike St., Dr.Shariyati Av.,
Roberoye Cerahe Mirdamad
Tehran, IRAN
TEL: (021) 285-4169

ISRAEL

Halilit P. Greenspan & Sons Ltd.
8 Retzif Ha'aliya Hashnya St.
Tel-Aviv-Yafo ISRAEL
TEL: (03) 6823666

JORDAN

MUSIC HOUSE CO. LTD.
FREDDY FOR MUSIC
P. O. Box 922846
Amman 11192 JORDAN
TEL: (06) 5692696

KUWAIT

EASA HUSAIN AL-YOUSIFI & SONS CO.
Abdullah Salem Street,
Safat, KUWAIT
TEL: 243-6399

LEBANON

Chahine S.A.L.
Gerge Zeidan St., Chahine
Bldg., Achrafieh, P.O.Box: 16-
5857
Beirut, LEBANON
TEL: (01) 20-1441

OMAN

TALENTZ CENTRE L.L.C.
Malatan House No.1
Al Noor Street, Ruwi
SULTANATE OF OMAN
TEL: 2478 3443

QATAR

Al Emadi Co. (Badie Studio & Stores)
P.O. Box 62, Doha, QATAR
TEL: 4423-554

SAUDI ARABIA

aDawlah Universal Electronics APL
Corniche Road, Aldossary
Bldg., 1st Floor, Alkhobar,
SAUDI ARABIA

P.O.Box 2154, Alkhobar 31952
SAUDI ARABIA
TEL: (03) 898 2081

SYRIA

Technical Light & Sound Center
Rawda, Abdul Qader Jazairi St.
Bldg. No. 21, P.O.BOX 13520,
Damascus, SYRIA
TEL: (011) 223-5384

TURKEY

ZUHAIL DIS TICARET A.S.
Galip Dede Cad. No.37
Beyoglu - Istanbul / TURKEY
TEL: (0212) 249 85 10

U.A.E.

Zak Electronics & Musical Instruments Co. L.L.C.
Zabeel Road, Al Sherooq Bldg.,
No. 14, Grand Floor, Dubai,
U.A.E.
TEL: (04) 3360715

NORTH AMERICA

CANADA

Roland Canada Music Ltd.
(Head Office)
5480 Parkwood Way
Richmond B. C., V6V 2M4
CANADA
TEL: (604) 270 6626

Roland Canada Music Ltd.

(Toronto Office)
170 Admiral Boulevard
Mississauga On L5T 2N6
CANADA
TEL: (905) 362 9707

U. S. A.

Roland Corporation U.S.
5100 S. Eastern Avenue
Los Angeles, CA 90040-2938,
U. S. A.
TEL: (323) 890 3700

For EU Countries



This product complies with the requirements of European Directive 89/336/EEC.

For the USA

FEDERAL COMMUNICATIONS COMMISSION RADIO FREQUENCY INTERFERENCE STATEMENT

This equipment has been tested and found to comply with the limits for a Class B digital device, pursuant to Part 15 of the FCC Rules. These limits are designed to provide reasonable protection against harmful interference in a residential installation. This equipment generates, uses, and can radiate radio frequency energy and, if not installed and used in accordance with the instructions, may cause harmful interference to radio communications. However, there is no guarantee that interference will not occur in a particular installation. If this equipment does cause harmful interference to radio or television reception, which can be determined by turning the equipment off and on, the user is encouraged to try to correct the interference by one or more of the following measures:

- Reorient or relocate the receiving antenna.
- Increase the separation between the equipment and receiver.
- Connect the equipment into an outlet on a circuit different from that to which the receiver is connected.
- Consult the dealer or an experienced radio/TV technician for help.

This device complies with Part 15 of the FCC Rules. Operation is subject to the following two conditions:

- (1) This device may not cause harmful interference, and
- (2) This device must accept any interference received, including interference that may cause undesired operation.

Unauthorized changes or modification to this system can void the users authority to operate this equipment.
This equipment requires shielded interface cables in order to meet FCC class B Limit.

For Canada

NOTICE

This Class B digital apparatus meets all requirements of the Canadian Interference-Causing Equipment Regulations.

AVIS

Cet appareil numérique de la classe B respecte toutes les exigences du Règlement sur le matériel brouilleur du Canada.

Free Manuals Download Website

<http://myh66.com>

<http://usermanuals.us>

<http://www.somanuals.com>

<http://www.4manuals.cc>

<http://www.manual-lib.com>

<http://www.404manual.com>

<http://www.luxmanual.com>

<http://aubethermostatmanual.com>

Golf course search by state

<http://golfingnear.com>

Email search by domain

<http://emailbydomain.com>

Auto manuals search

<http://auto.somanuals.com>

TV manuals search

<http://tv.somanuals.com>