

# MicroComposer

## MC-4

— OPERATION MANUAL —

 Roland®



## TABLE OF CONTENTS

	Page
<b>CHAPTER ONE:</b> BASIC CONCEPTS PROGRAMMING A SINGLE VOICE EXAMPLE	2
<b>CHAPTER TWO:</b> CASSETTE OPERATION SAVING, VERIFYING AND LOADING	16
<b>CHAPTER THREE:</b> ADVANCED CONCEPTS PROGRAMMING A MULTI-VOICE EXAMPLE USING A PROGRAM SHEET	21
<b>CHAPTER FOUR:</b> LIVE KEYBOARD ENTRY SINGLE VOICE EXAMPLE MULTI-VOICE EXAMPLE ADVANCED CONCEPTS	42
<b>CHAPTER FIVE:</b> TAPE SYNCHRONIZATION USAGE IN A STUDIO MULTI-TRACK RECORDING	61
<b>APPENDIX A:</b> FUNDAMENTAL AND EXTENDED COMMAND SUMMARY TIMEBASE CHART	67
<b>APPENDIX B:</b> DETAILED HOOKUP DIAGRAMS	82
<b>APPENDIX C:</b> USEFUL PROGRAMMING HINTS USING EXTENDED FUNCTIONS	86
<b>APPENDIX D:</b> DIGITAL CASSETTE OPERATION	91
<b>APPENDIX E:</b> MC-4 TECHNICAL SPECIFICATIONS	99





# The ROLAND MC-4 MICROCOMPOSER [tm] OPERATING MANUAL

## INTRODUCTION

The **ROLAND MC-4** is a programmable, **multi-channel sequencer** which allows the musician to create synthesizer performances previously unattainable by conventional playing methods.

The MC-4 may be programmed with the **calculator keyboard** (10 key), or with a conventional **synthesizer keyboard** utilising the keyboards control voltage and gate outputs.

The MC-4 was created by a **musician** to enable musicians and composers to put the **majority** of their efforts into **creativity** rather than merely perfecting technique on an instrument. Musical expressions, such as **PHRASING and DYNAMICS**, usually difficult to master, are simple keystroke functions on the MC-4.

By numbering the notes on the piano keyboard, all of the pitches over the entire musical range may be specified. By assigning number values for duration, phrasing, dynamics, timbre and tempo, all of the subtle nuances required of a **real "HUMAN" performance** are easily programmed into the MC-4's computer memory.

If your main interest in using the MC-4 is with **LIVE KEYBOARD ENTRY**, then skip the first chapters and proceed directly to the chapter on live keyboard programming.

# CHAPTER ONE

## CALCULATOR KEYBOARD PROGRAMMING

### 1A: HOOK UP

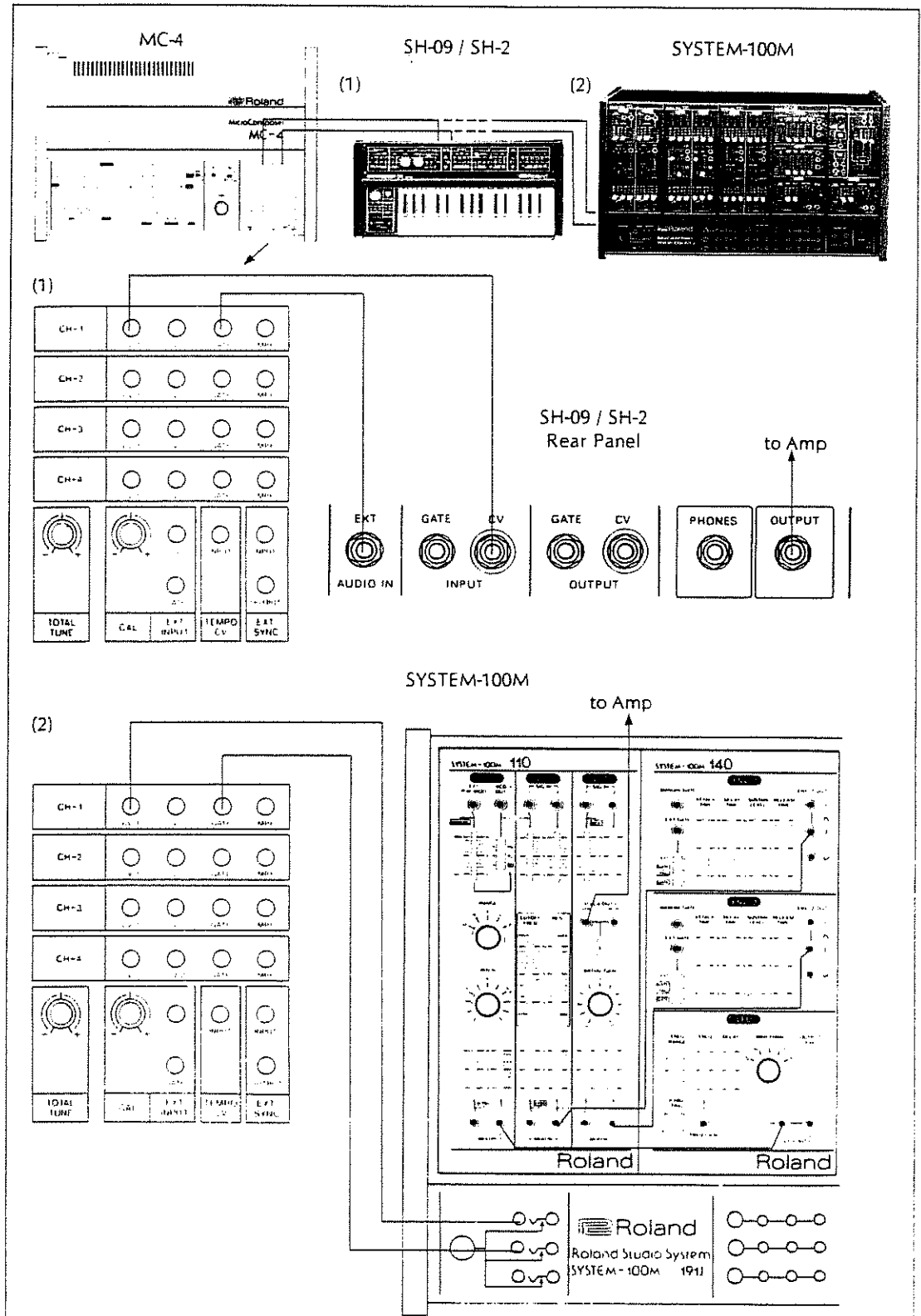
The following diagrams show the recommended hook up (or patching) of the MC-4 to a conventional **voltage controlled synthesizer**. These will apply to any synthesizer with **external control voltage (CV)** and **GATE** inputs. Referring to the fold out hook up **diagram 1A-1**, follow these easy, step by step instructions....

#### PATCH CORDS

The MC-4 uses 3.5mm. **mini phone jacks** which will patch directly to ROLAND SYSTEM 100 & 100M synthesizers. Other ROLAND synths require **1/4 inch phone adapters**. Be sure that you have the proper patch cords and adapters for your particular system. Once this is looked after, proceed as follows:

On the right hand side of the MC-4, you will notice an output patch bay. In this chapter, we will be programming a single-voice musical example and will patch **CHANNEL 1** of the MC-4 to a single-voice synthesizer.

DIAGRAM 1A-1:



**First, turn on the power switch on the rear of the MC-4!**

- 1: Patch **control voltage 1 (CV-1), channel 1**, to the **VCO CV INPUT** on the synthesizer.
- 2: Patch **Channel 1 GATE** output to the **envelope generator (ADSR) GATE INPUT, external mode**, on the synthesizer.
- 3: Insure that the **ENV. GEN.** on the synthesizer is patched to the **VCA**.
- 4: Insure that the **VCF** is **open** on the synthesizer.
- 5: Insure that the **synth** is hooked up to an **amplifier**.
- 6: Adjust the **ENV. GEN.** to produce a **sustained** envelope.
- 7: To verify that you are getting a result from the MC-4, **hold down the blue SHIFT key** on the MC-4, and press **#9** on the calculator keyboard. You should hear a tone, and that is the **tuning key**. Tune the **VCO** to **A 440Hz**.
- 8: To turn the **tone off**, press **any key**.

This is the basic hook up procedure for a **single voice** synthesizer. For **multi-voice** systems, follow the **same procedure** with **channel 2** for the second voice, **channel 3** for the third voice etc....



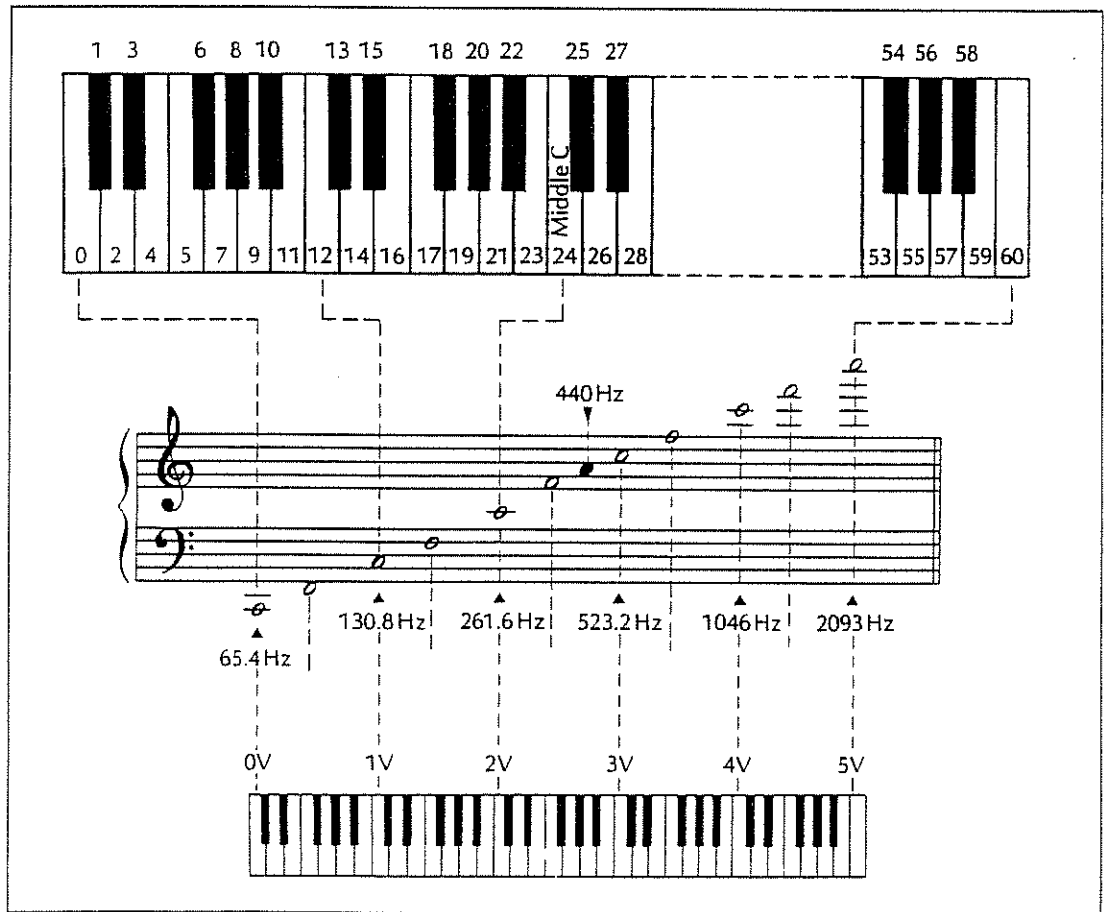
## 1B: CONCEPTS IN PROGRAMMING

Before going into the programming functions on the MC-4, there are a few concepts to discuss. As mentioned in the introduction, **numerical values** may be assigned to control the functions on the MC-4.

The **first set** of number values will control **itches**. We have set up a very simple system of **encoding musical notes** with numbers, by simply **counting up the notes** on the piano keyboard. The MC-4 translates these numbers into very precise **control voltages**.

These voltages set the **voltage controlled oscillators (VCOs)** to very accurate **itches** in semitones.

DIAGRAM 1B-1:



Now that we can see how **pitches** are programmed into the MC-4, the second concept to deal with is that of **time values**.

When we first turn the power on, the display on the MC-4 will read:

TB 120 30 15

**TB** refers to **time base**, or the number of divisions per beat.

The number **30** refers to **STEP TIME**, and the number **15** refers to **GATE TIME**. These values which appear on the display when the computer is turned on, are called **DEFAULT VALUES**. There are many different default **values** and default **functions** in the MC-4. Any value not entered or changed is then **automatically selected by default**.

The **STEP TIME** value determines the **time interval between each note (time value)**, and the **GATE TIME** refers to the **actual sounded value**.

I.E; whether the **PHRASING** is legato, staccato, semi-detached etc.

**TABLE 1B-1:**

STEP TIME values if TIMEBASE = 120 divisions/beat in 4/4 time.		
WHOLE NOTE	480	(4 x 120)
HALF NOTE	240	(2 x 120)
1/4 NOTE	120	(TIMEBASE value)
1/8 NOTE	60	(120 divided by 2)
1/16 NOTE	30	(120 divided by 4)

The **TIME BASE, STEP TIME, GATE TIME** relationship will become more apparent as you go through the step by step programming.

Refer to **APPENDIX A-3**.

## 1C: BASIC KEY FUNCTIONS

You will now take a short walk through the MC-4's key functions, to become familiar with the keys before learning to program.

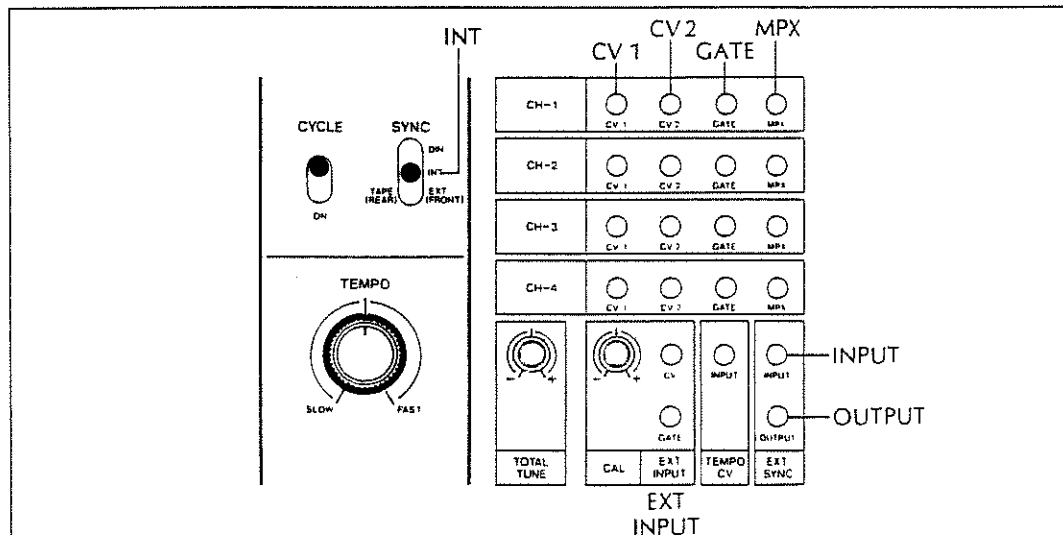
You have already seen the **OUTPUT** section when the MC-4 was **patched** to the synthesizer. Notice that there are outputs for **CV-1, CV-2, GATE,** and **MPX** (multiplex), for all **four channels** on the MC-4.

When entering data in the **CV-1** memory, that data goes to the **OUTPUT CV-1** when playing the program. It is important to note that **CV-1** is usually used for controlling the **pitch** information. The data entered in **CV-2**, can be used for controlling the **VCF**, the **VCA**, or any other **voltage controlled** function on the synthesizer. The **GATE** output is always patched to the **ENV. GEN.**, and the data entered in the **GATE** mode are the values used for the **gate times**.

The **MPX** is another gate output, used for triggering other functions on the synthesizer. See **APPENDIX C**.

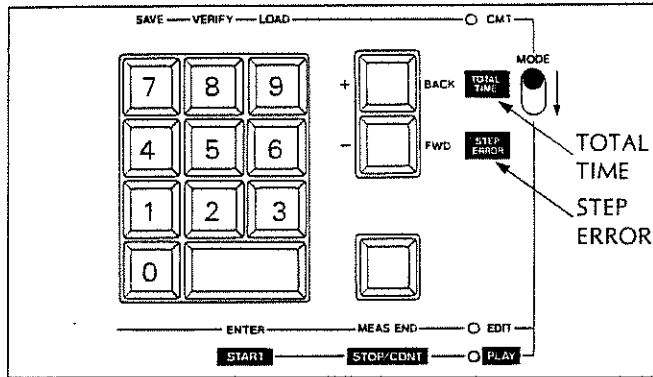
To the left of the **OUTPUT** section, there are two switches: **CYCLE**, (which allows the program to repeat continuously when in the **ON** position in the **PLAY** mode) and **SYNC**, (which should always be in the **INT** position, except when synchronizing to tape or other **ROLAND** products). See **CHAPTER 5**.

**DIAGRAM 1C-1:**



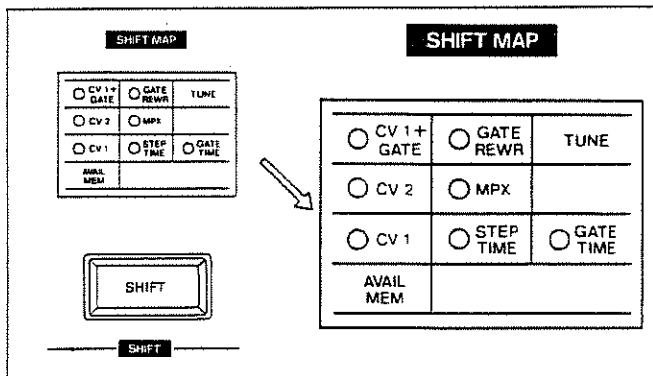
In the center, is the **CALCULATOR KEYBOARD** section, which has a numbered keypad, with the **ENTER** key below, and two blue keys to the right (**BACK/FORWARD**), and the **MEASURE END** key below them.

**DIAGRAM 1C-2:**



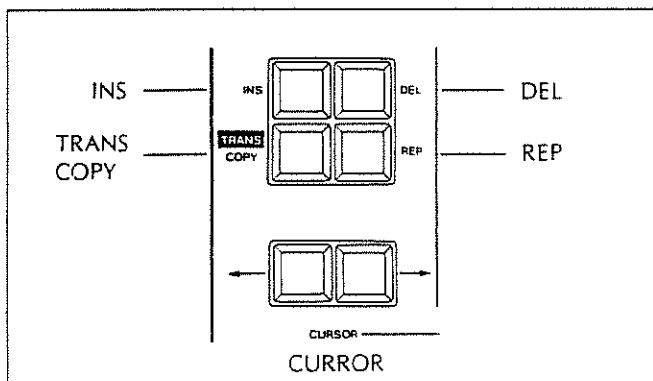
To the left of the keypad, is the **SHIFT MAP**, and a blue **SHIFT** key below it.

**DIAGRAM 1C-3:**



On the very left of the machine, are the editing keys; **INSERT**, **DELETE**, **COPY (TRANSPose)**, & **REPEAT**.

**DIAGRAM 1C-4:**



At this time, refer to **TABLE 1C-1**, and try the **key functions** to become familiar with them.

Take careful notice of the **display** read out after each entry, and also notice the **status indicators**.

The MC-4 has several **status indicators**, which are small red lights (LEDs) on the front panel. To the left of the **calculator keyboard**, there is a group of LEDs arranged in the same order as the keyboard. This is called the **SHIFT MAP** and shows us the current memory being used. When the MC-4 is **powered on**, the **SHIFT MAP LED** indicates that CV 1 is active. This is a **default function**.

**TABLE 1C-1:**

	<u>COMMAND</u>	<u>DISPLAY</u>	<u>STATUS (leds)</u>
1:	<b>POWER ON</b>	TB 120 30 15	EDIT, CV1.
2:	<b>SHIFT 2</b>	(no change)	STEP TIME.
3:	<b>SHIFT 3</b>		GATE TIME.
4:	<b>SHIFT 4</b>		CV2.
5:	<b>SHIFT 5</b>		MPX.
6:	<b>SHIFT 6</b>		See APPENDIX A-6.
7:	<b>SHIFT 7</b>		CV1 + GATE.
8:	<b>SHIFT 8</b>		GATE REWRITE.
9:	<b>SHIFT 9</b>	CV1=33	Tune to A 440Hz.
10:	<b>SHIFT 0</b>	100.0%	Memory remaining.
11:	<b>SHIFT 1</b>		CV1 (default).
12:	<b>CURSOR &gt;</b>	TEMPO 100 L	default tempo.
13:	<b>CURSOR &gt;</b>	-	cursor symbol.
14:	<b>CURSOR &gt; 3X</b>	1 1 1 -	ready for data.
15:	<b>CURSOR &lt; 5X</b>	TB 120 30 15	back to beginning.
16:	<b>MODE DOWN</b>	1 1 1 PLAYL	PLAY mode.
17:	<b>MODE DOWN</b>	A-CMT MODE	AUDIO CASSETTE mode.
18:	<b>MODE DOWN</b>	1 1 1 -	EDIT mode (data entry).

Here are some of the **basic functions** which will be used for the **first programming example**.

**TABLE 1C-2:**

1:	TUNING.....	SHIFT 9
2:	Selecting EDIT MODE	
3:	Changing TEMPO	
4:	Entering PITCHES.....	CV-1
5:	Entering TIME VALUES.....	STEP TIME
6:	Entering PHRASING .....	GATE TIME
7:	Stepping BACK and FORWARD through the program	
8:	PLAYING the program	

## 1D: PROGRAMMING THE MC-4

You are now ready to enter the first single voice musical example into the MC-4. It is important to follow each instruction very carefully. Notice the **display** read out after each entry, and also notice **which status indicators are lit**.

### 1: POWER ON

**DISPLAY READS:** TB 120 30 15

The default timebase value will be used, so press either **cursor right '>'**, or **MEAS END**.


**DISPLAY READS:** TEMPO 100 

### 2: Change the default TEMPO value. Type 120 ENTER. (120 beats/minute).

**DISPLAY READS:** 

### 3: Enter the PITCH values for CV1, CHAN. 1: Type the ENTER key 3 times.

After pressing the **ENTER** key, the MC-4 will go to the last **initial command level**, which is the **CHANNEL, MEASURE, STEP** selection.

The  shape is the **cursor**. This is an indicator which shows the current position in this **command level**. At this point, the legends under the display are in effect.

The MC-4 is pre-programmed with **default channel, measure, and step** locations, and these are **CHANNEL 1, MEASURE 1, STEP 1**. To select these values, simply press any of the three keys; **CURSOR RIGHT, ENTER, or MEASURE END**. Press the key 3 times and after each key press, the display will show 1, then another 1, and yet another 1 followed by a dash. "—". The "—" indicates that the MC-4 is waiting for **PITCH** values in CV 1.

**DISPLAY READS:** 1 1 1 —

TABLE 1D-1: Pitch values for CHAN 1, CV 1.

	COMMAND	DISPLAY				DISPLAY			
		(key down)				(key up)			
1:	Type 24 ENTER	1	1	1	24	1	1	2	-
2:	28 ENTER	1	1	2	28	1	1	3	-
3:	31 ENTER	1	1	3	31	1	1	4	-
4:	28 ENTER	1	1	4	28	1	1	5	-
5:	31 MEAS END	1	1	5	31	1	2	1	-
6:	29 ENTER	1	2	1	29	1	2	2	-
7:	31 ENTER	1	2	2	31	1	2	3	-
8:	33 ENTER	1	2	3	33	1	2	4	-
9:	35 ENTER	1	2	4	35	1	2	5	-
10:	36 ENTER	1	2	5	36	1	2	6	-
11:	31 ENTER	1	2	6	31	1	2	7	-
12:	28 ENTER	1	2	7	28	1	2	8	-
13:	26 MEAS END	1	2	8	26	1	3	1	-
14:	24 ENTER	1	3	1	24	1	3	2	-
15:	28 ENTER	1	3	2	28	1	3	3	-
16:	31 ENTER	1	3	3	31	1	3	4	-
17:	28 ENTER	1	3	4	28	1	3	5	-
18:	31 MEAS END	1	3	5	31	1	4	1	-
19:	29 ENTER	1	4	1	29	1	4	2	-
20:	28 ENTER	1	4	2	28	1	4	3	-
21:	26 ENTER	1	4	3	26	1	4	4	-
22:	31 ENTER	1	4	4	31	1	4	5	-
23:	24 MEAS END	1	4	5	24	1	5	1	-

(end)

MUSICAL EXAMPLE

By Barry Creamer



**NOTE:**

**a:** When the **ENTER** key is **held down**, the note will **sound** and the **display** will show the **current measure, step** and **data**. When **released**, the sound will **stop**, and the **display** will **advance** to the next step.

**b:** If the **MEASURE END** key is used, then the same thing occurs except the **meas will advance** and the **step will reset to 1**.

If a **MEAS END** is **missed**, the use **BACK** or **FWD** keys to find **starting** note of the supposed **measure**, then press **SHIFT MEAS END**. This will **insert a MEASURE END**. Use **BACK & FWD** keys to **verify the measure & step count**.

**c:** If a **wrong entry** is made, then **press SHIFT 0** to **clear** the bad entry. The **display** will show **memory remaining** as a percentage, then when **SHIFT 0** is released, the entry is **cleared**. (This must be done **prior to pressing ENTER** or **MEAS END**). The correct data may then be typed.

If data is **already entered**, then **BACK** step and **type correct data**, then **ENTER**.

**d:** The **display** will show the data on the **left** side of the data column **before pressing ENTER** or **MEAS END**, and **while holding ENTER** or **MEAS END down**, the **stored data** will show on the **right** hand data column. When **released**, the display will **advance to the next step**.

**e:** If you are not familiar with entering notes as CV data by using the **calculator keyboard**, you may use the **synthesizer keyboard**. This method is a **very useful** function of the MC-4. For details, see **CHAPTER FOUR [4B: 4C: and 4F]**.

To enter **measure lines**, press **SHIFT ME** instead of just pressing **ME**. For details, see **APPENDIX A-6**.

**4: ENTER the STEP TIME VALUES for ST.**

These are all of the **pitch values** for the four bar example. Before entering the **step time** values, go to the beginning of the program. The easiest way to do this is to press the **FWD** key to the right of the **calculator keyboard**.

**DISPLAY READS: CHAN. 1, MEAS. 1, STEP 1, 24.**

**NOTE:**

Experiment with the **BACK** and **FWD** keys. These will allow you to change notes or correct minor errors in entering data and will also single step through the melody.

In **all memories other than CV 1**, the **last entry** will **not advance**, but will **beep** instead to indicate the **end of CV entries!**

These are all of the **step time** values for the four bars. Notice that **MEASURE ENDS were not used**. The **MEASURE END** command is required in **CV-1 only**.

Also, if the number value of the **STEP TIME** does not need to change, it is not necessary to retype these numbers. Simply **press the FWD key**.



**TABLE 1D-2: Step Time values for CHAN 1.**

COMMAND		DISPLAY				DISPLAY			
		(key down)				(key up)			
	Type SHIFT 2	1	1	1	30	(same)			
1:	120 ENTER	1	1	1	120	1	1	2	30
2:	ENTER	1	1	2	120	1	1	3	30
3:	ENTER	1	1	3	120	1	1	4	30
4:	60 ENTER	1	1	4	60	1	1	5	30
5:	ENTER	1	1	5	60	1	2	1	30
(MEAS. +1)									
6:	ENTER	1	2	1	60	1	2	2	30
7:	ENTER	1	2	2	60	1	2	3	30
8:	ENTER	1	2	3	60	1	2	4	30
9:	ENTER	1	2	4	60	1	2	5	30
10:	ENTER	1	2	5	60	1	2	6	30
11:	ENTER	1	2	6	60	1	2	7	30
12:	ENTER	1	2	7	60	1	2	8	30
13:	ENTER	1	2	8	60	1	3	1	30
(MEAS. +1)									
14:	120 ENTER	1	3	1	120	1	3	2	30
15:	ENTER	1	3	2	120	1	3	3	30
16:	ENTER	1	3	3	120	1	3	4	30
17:	60 ENTER	1	3	4	60	1	3	5	30
18:	ENTER	1	3	5	60	1	4	1	30
(MEAS. +1)									
19:	ENTER	1	4	1	60	1	4	2	30
20:	ENTER	1	4	2	60	1	4	3	30
21:	ENTER	1	4	3	60	1	4	4	30
22:	ENTER	1	4	4	60	1	4	5	30
23:	240 ENTER	1	4	5	240	1	4	5	240
(beep)									

**5: ENTER the GATE TIME VALUES for GT:**

Before entering the GATE TIME values, go to the beginning of the program again, by pressing the FWD key.

DISPLAY READS: 1 1 1 120

TABLE 1D-3: Gate Time values for CHAN 1.

COMMAND	DISPLAY				DISPLAY			
	(key down)				(key up)			
Type SHIFT 3	1	1	1	15	1	1	1	15
					(default)			
1: 50 ENTER	1	1	1	50	1	1	2	15
2: ENTER	1	1	2	50	1	1	3	15
3: 100 ENTER	1	1	3	100	1	1	4	15
4: 25 ENTER	1	1	4	25	1	1	5	15
5: ENTER	1	1	5	25	1	2	1	15
					(MEAS. +1)			
6: 50 ENTER	1	2	1	50	1	2	2	15
7: 25 ENTER	1	2	2	25	1	2	3	15
8: ENTER	1	2	3	25	1	2	4	15
9: ENTER	1	2	4	25	1	2	5	15
10: 50 ENTER	1	2	5	50	1	2	6	15
11: 25 ENTER	1	2	6	25	1	2	7	15
12: ENTER	1	2	7	25	1	2	8	15
13: 50 ENTER	1	2	8	50	1	3	1	15
					(MEAS. +1)			
14: ENTER	1	3	1	50	1	3	2	15
15: ENTER	1	3	2	50	1	3	3	15
16: 100 ENTER	1	3	3	100	1	3	4	15
17: 25 ENTER	1	3	4	25	1	3	5	15
18: ENTER	1	3	5	25	1	4	1	15
					(MEAS. +1)			
19: 50 ENTER	1	4	1	50	1	4	2	15
20: 25 ENTER	1	4	2	25	1	4	3	15
21: ENTER	1	4	3	25	1	4	4	15
22: ENTER	1	4	4	25	1	4	5	15
23: 200 ENTER	1	4	5	200	1	4	5	200
					(beep)			

You have now entered all of the **pitch** values in CV-1, all of the **time** values of the notes in STEP TIME memory, and the **phrasing** values for the notes in the GATE TIME memory.

Press **SHIFT 1** to return to CV 1, then press **FWD** two times to loop to the **beginning**.

DISPLAY SHOWS: 1 1 1 24

## 1E: PLAYING THE PROGRAM

Having executed these commands step by step, you should now be able to hear the musical example by putting the MC-4 into the **Play** mode. To go into the **PLAY** mode, simply push the **MODE** switch to the right of the calculator keypad down.

**DISPLAY READS:**      1    1    1 PLAY

The status indicator will also read **PLAY** (below the **MEAS END** key).

When in the **PLAY** mode, the **ENTER** and **MEASURE END** keys become **START** and **STOP/CONTINUE** keys respectively. Note the color coding here. To play the program, simply press the **START (ENTER)** key, and the piece will play to the end. Try this again, but press the **STOP/CONT (ME)** key half way through the example. The program will **STOP**. By pressing the **STOP/CONT** key, again, the program will **play from the stopping point**.

Push the **CYCLE** switch to the **ON** position. The program will continue to repeat until the **STOP/CONT** key is pressed.

## 1F: SUMMARY OF CHAPTER ONE

To reinforce what you have learned in Chapter one, repeat all of the keystrokes in the Single Voice example. These should become second nature after several times through, so that you will be prepared for the following chapters.

Pick out a **simple** tune of your own and convert the **itches** to CV 1 numbers, then do the same for **STEP & GATE TIMES**. Enter these numbers, using the same procedure as in the **single voice example**, and try **playing** the program.

If you have any problems, then **double check** all of the entries against the values chosen for the tune. This is the **best way** to reinforce the commands used in **CHAPTER ONE**.

See **APPENDIX A** for the **complete command summary**.

Because the MC-4 **loses** its **memory** when the power is turned off, the MC-4 is equipped with a **very reliable cassette storage system**. This will allow you to **SAVE & LOAD programs** with **ease and convenience**.

This is the subject of the **next chapter**.

## CHAPTER TWO

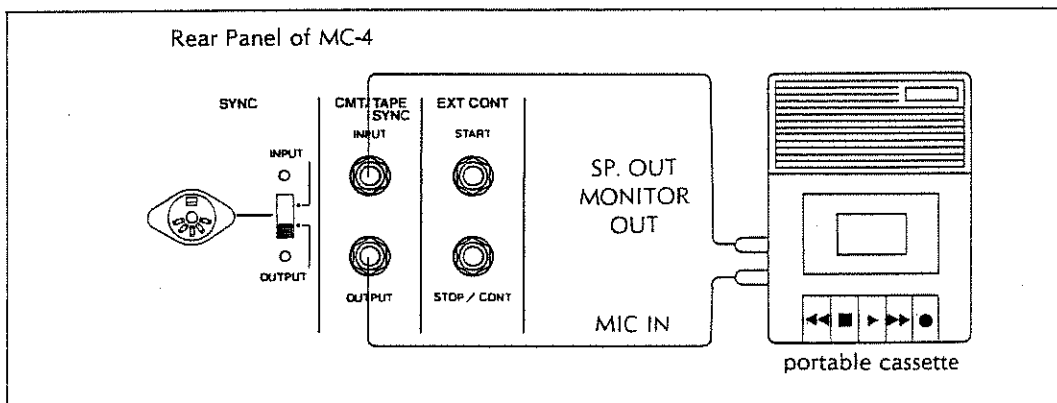
### CASSETTE OPERATION

#### 2A: SAVING A PROGRAM HOOK UP

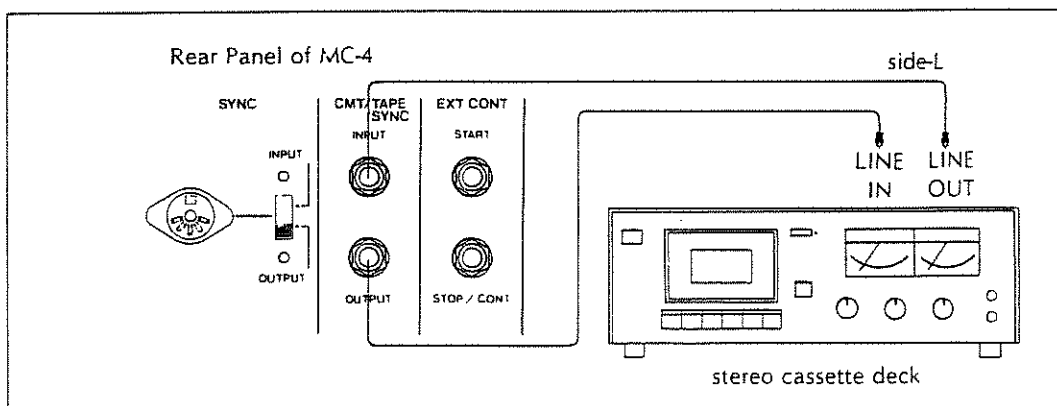
The following diagrams illustrate the normal cassette patching for two types of recorders; **Diagram 2A-1** refers to a portable inexpensive recorder with an **auxiliary input** (high level), and an earphone output (high level). **Diagram 2A-2** refers to a standard stereo cassette deck with line inputs, (high level) and line outputs (low level).

For **DIGITAL CASSETTE** users, refer to **APPENDIX D** for complete details.

**DIAGRAM 2A-1:** portable cassette



**DIAGRAM 2A-2:** stereo cassette deck



## 2B: PROPER INPUT AND OUTPUT LEVELS

When using a **portable cassette** with AVC (automatic volume control), the recorded signal from the MC-4 will be adjusted in level automatically by the AVC on the cassette recorder. This should present no problems, but if the input to the recorder is being **overloaded**, then see **Diagram 2B-1** for details on attenuating the output signal from the MC-4.

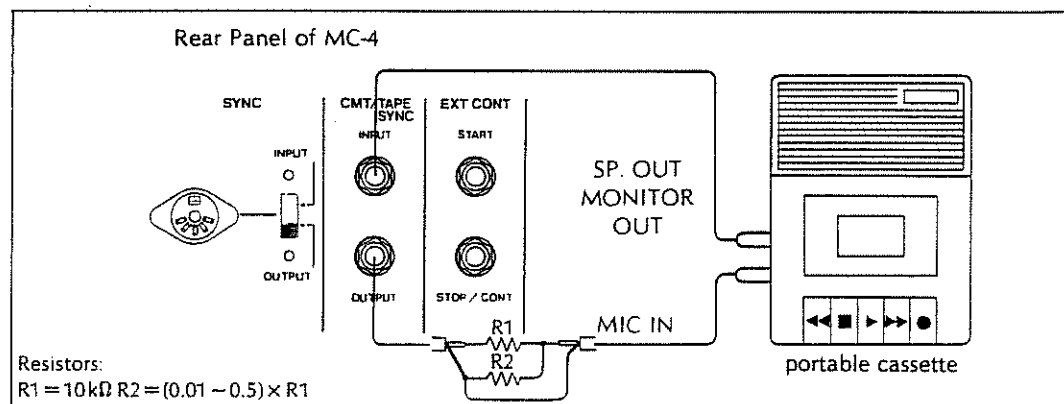
The output level from the recorder is adjustable with the VOLUME control and is best determined by trial and error. This will be discussed in the section on **verifying** the program.

When using a **stereo cassette deck**, the recorded signal from the MC-4 will have to be adjusted with the **line input** level control on the cassette deck. This should be set to **0 db** on the VU meter.

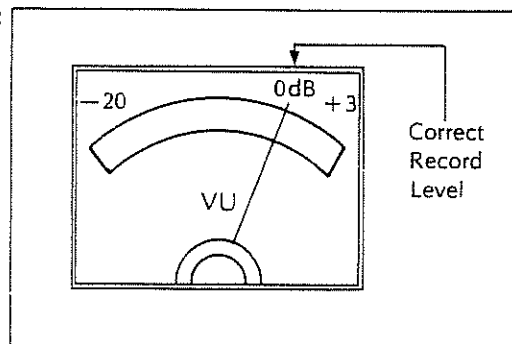
On some recorders, the **output** level is not adjustable when using the **line** outputs. If this presents a **problem** when **verifying** or **loading**, then use the **headphone output**, which is usually adjustable.

The MC-4 has a fairly wide tolerance to various playback levels, but ideally the output from the recorder should be at a **medium** setting of the **output** and **tone** (if available) controls. The recommended recorder output level is **1 volt pp.** (peak to peak).

**DIAGRAM 2B-1:**



**DIAGRAM 2B-2:**



## 2C: COMMANDS OF CMT MODE

The **cassette memory transfer (CMT)** mode is selected by pressing the **MODE** switch to the right of the calculator keyboard two times. The first time the MC-4 will be in the **PLAY** mode and pressing the **MODE** switch a second time will put the MC-4 into the **CMT** mode.

The **DISPLAY** will show:       A-CMT MODE

indicating that it is in the **audio cassette memory transfer** mode and is waiting for a command.

The **key functions** in the **CMT** mode are:

'7' key is the **SAVE** key.

'8' key is the **VERIFY** key.

'9' key is the **LOAD** key.

For test purposes, you will save **single voice example** program which should still be in the MC-4 memory. If it isn't, then re-enter the program in **CHAPTER ONE**.

## 2D: The SAVE function (FILE NUMBERS)

Programs saved using the **SAVE** function may be **identified** by giving the program a **file number** of up to **ten digits** in length. The '+' and '-' keys may be used as **separators** or **punctuation** within the **file number**. This way, programs may be **loaded** by **file number**, allowing the user to keep a record and organized file system of programs. This is a very handy feature of the MC-4.

The **SAVE** procedure is as follows:

1:     **Press '7' (save)**                   SU \_ (waiting for File number)

2:     **Press '1' (name)**               SU 1\_

3:     **At this point, START the recorder in RECORD!**

4:     **Press MEAS END**               SU 1       :1

5: The MC-4 will **beep** several times indicating that it is **SAVING** the program. The **channel** being **saved** will be displayed at the right hand side of the display.

When it is finished **saving**, the display will show:

  END1       :1

At this point, the recorder should be stopped and rewound to the beginning of the program. Listen to the sound of the data on the tape; it should sound like a heavily modulated tone. If this is not the case, then repeat steps 1 thru 5.

## 2E: VERIFYING THE SAVED PROGRAM

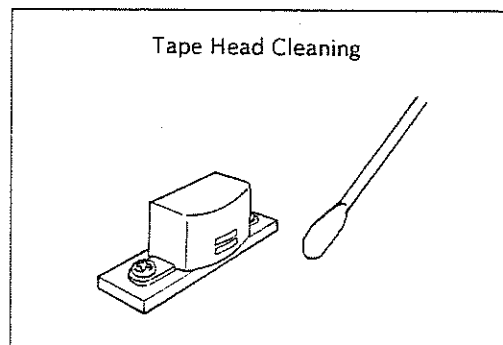
The **VERIFY** function is used to compare the data on tape to the data in the memory of the MC-4. While still in the **CMT** mode, proceed as follows:

	COMMAND	DISPLAY	
1:	Press '8'	UF L	(VERIFY function)
2:	Press '1'	UF 1L	(file number)
3:	At this point, make sure the recorder is rewound to the start of the program and that the level is at a medium setting.		
4:	<b>Start the recorder in PLAY.</b>		
5:	Press MEAS END	FN :1	(MC-4 is VERIFYING program)
6:	If the data is OK, then the display will show:		
		OK 1 :1	
	If the display shows:		
		ERR1 :1	

Then rewind the tape and set to a **higher** level and repeat steps 1 to 6. This may have to be repeated several times, with **higher** and **lower levels** until the best output level is obtained from the recorder.

### NOTE:

If the **verify** function still reads **ERR** then check the tape recorder for dirt on the heads and clean if necessary. If this doesn't help, then change brands of tape, using a good quality brand. If this fails, try another recorder. These are worst case options and should not prove necessary.



## 2F: LOADING THE PROGRAM

Now that a properly verified program has been saved on tape, the tape may be stored indefinitely for future use. To **LOAD** the program back into the MC-4, the tape **level** and **tone** settings should be the same as used for **verifying** the program. **When the MC-4 is turned off, the program in memory disappears.** The procedure for loading the program is as follows:

	COMMAND	DISPLAY
1:	Power on	TB 120 30 15
2:	MODE 2X	A-CMT MODE
3:	Press '9'	LD L
4:	Press '1'	LD 1L (file number)

5: The tape should be positioned to the beginning of the data for program #1 and the **level** and **tone** should be the same as in the **VERIFY** mode.

6: Start the recorder

7: Press MEAS END

The MC-4 will BEEP and show: FN 1 : 1

to indicate that it has found the data and when loading is done, the display will show:

END1 : 1

If the display shows: ERR1 : 1

then use the same procedures as in the **VERIFY** section.

## 2G: SUMMARY OF CHAPTER TWO

This completes the basic **cassette (CMT)** operations. For a detailed description of the more advanced CMT functions, see **APPENDIX A-8**.



# CHAPTER THREE

## BASIC EDITING FUNCTIONS

### PROGRAMMING A MULTI-VOICE EXAMPLE

#### 3A: INTRODUCTION

In this chapter, we will introduce the basic editing functions, as they are used in a four-voice musical example.

The programming procedures for multi-voice operation are the same as were outlined in **CHAPTER 1**, so familiarize yourself with the key functions in chapter 1 before proceeding.

As the editing functions are introduced, you will begin to see the beauty of the MC-4's operating system.

#### 3B: BASIC EDITING COMMANDS

Refer to **APPENDIX A** for detailed key strokes of **editing commands**.

- 1: **BACK/FORWARD** (refer to Chapter 1)
- 2: **INSERT**
- 3: **DELETE**
- 4: **COPY**
- 5: **TRANSPOSE**
- 6: **COPY with TRANSPOSE**
- 7: **REPEAT**
- 8: **COPY CHANNEL to CHANNEL**
- 9: **COPY STEP to GATE less fixed value**

The above list of commands will be used in one form or another in the programming of the following multi-voice example.

First of all, the MC-4 should be patched as in the next set of instructions.

### 3C: MULTI-VOICE HOOK-UP

The hookup for a multi-voice system is basically the same as for the single voice patch except that a larger synthesizer system is required, preferably one that is capable of producing 4 independent voices with individual control over **dynamics**.

If such a system is not available, then a smaller system, one that is capable of producing at least 2 independent voices will be adequate for illustrating the examples in this chapter.

The basic 'voice' should consist of:

- 1 VCO
- 1 VCF
- 1 (or 2) ADSRs
- 1 (or 2) VCAs

A simple mixer will be necessary to combine the signals, and as many patch cords as are available will be required. The hookup is the same as that used in **CHAPTER ONE**, with a couple of additions.

#### CHANNEL 1:

CV 1 — VCO 1  
CV 2 — VCA 1  
GATE — ENV GEN 1

#### CHANNEL 2:

CV 1 — VCO 2  
CV 2 — VCA 2  
GATE — ENV GEN 2

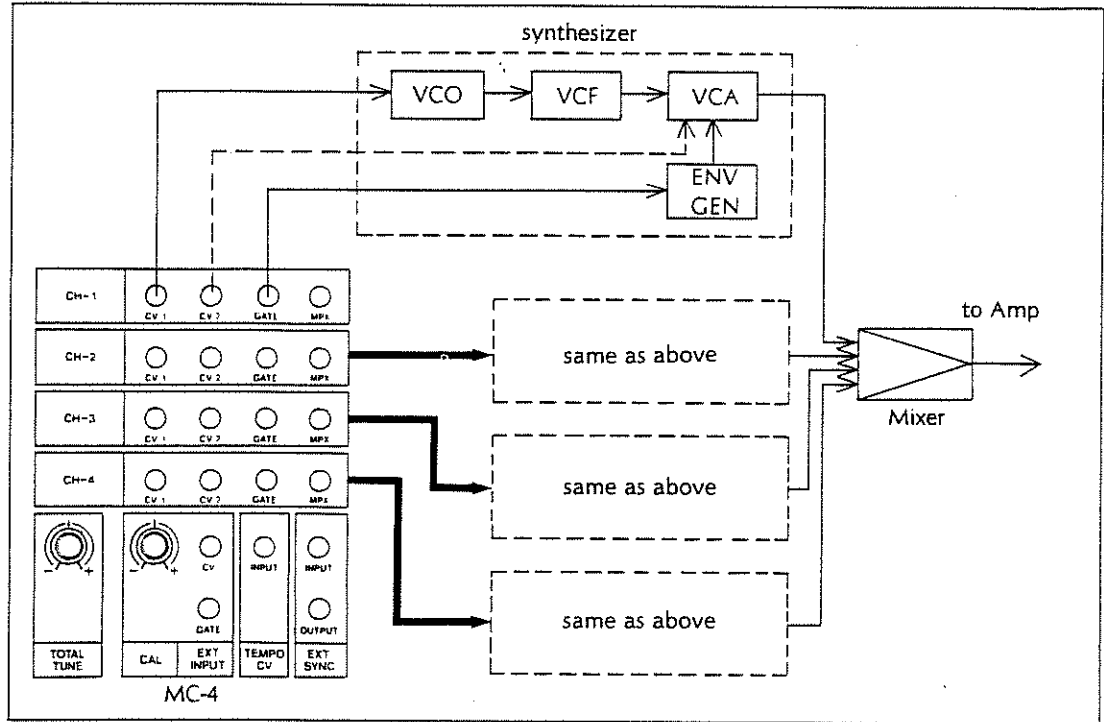
#### CHANNEL 3:

CV 1 — VCO 3  
CV 2 — VCA 3  
GATE — ENV GEN 3

#### CHANNEL 4:

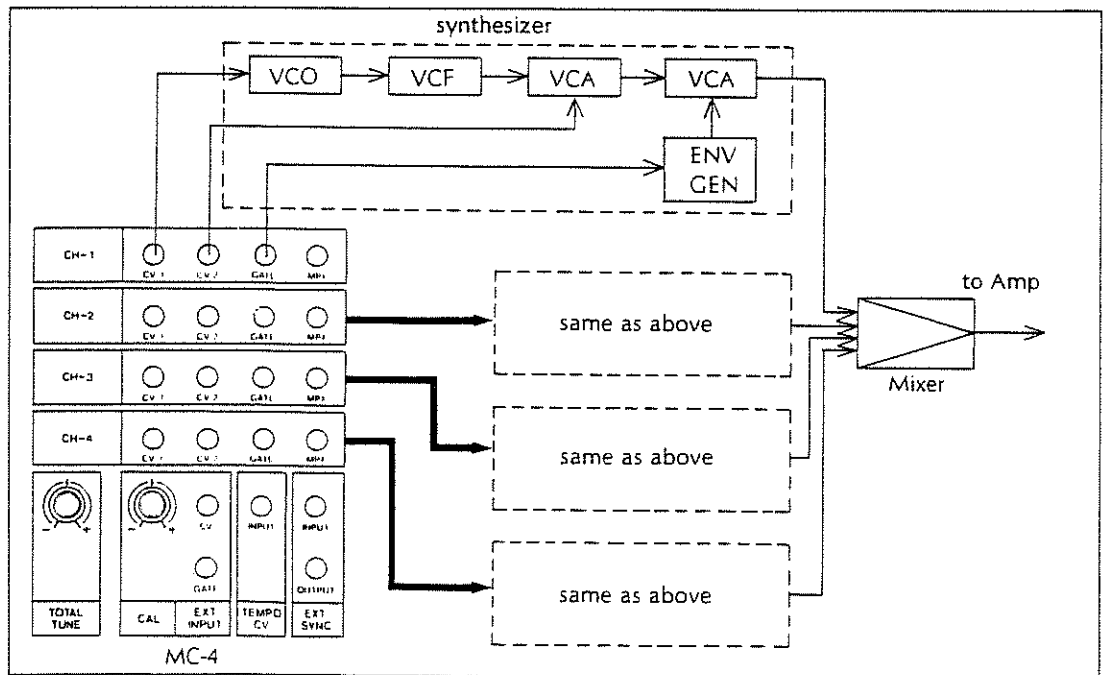
CV 1 — VCO 4  
CV 2 — VCA 4  
GATE — ENV GEN 4

**DIAGRAM 3C-1:**



If 2 VCAs per channel are available, then use the hookup in **DIAGRAM 3C-2**, as this is the preferred patch. Otherwise, use the patch in **DIAGRAM 3C-1**. See **APPENDIX B**.

**DIAGRAM 3C-2:**



### 3D: PROGRAMMING A MULTI-VOICE EXAMPLE

TABLE 3D-1 shows a list of the **keystroke commands** in full followed by a 2 character **short form code** which will be used to **simplyfy** the entries in the remaining chapters. These **short form codes** are used as **memory aids** to reduce the clutter when filling out **program sheets**.

TABLE 3D-1: COMMAND ABBREVIATIONS

FUNCTION	KEY LEGEND	SHORT FORM
TIMEBASE	POWER ON or CURSOR <—	TB
TEMPO	KNOB or CURSOR <— —>	TP
CHANNEL	CURSOR <— —>	CH
MEASURE	CURSOR " "	MES
STEP	CURSOR " "	STP
EDIT	CURSOR —> or MODE	ED
INSERT	INS	IN
DELETE	DEL	DL
COPY	COPY	CP
REPEAT	REP	RP
SHIFT	SHIFT	SH
CURSOR RIGHT	CURSOR —>	>
CURSOR LEFT	CURSOR <—	<
STEP BACK	BACK	BK
STEP FORWARD	FWD	FW
ENTER	ENTER	EN or ,
MEASURE END	MEAS END	ME
MODE	MODE	MD
CYCLE	CYCLE	CY
SYNC	SYNC	SY

TABLE 3D-1: (continued)

The following are <b>extended multi-key functions</b> . These are selected with the <b>SHIFT</b> key.		
CONTROL VOLTAGE 1	SHIFT 1	CV 1
CONTROL VOLTAGE 2	SHIFT 4	CV 2
STEP TIME	SHIFT 2	ST
GATE TIME	SHIFT 3	GT
MULTIPLEX	SHIFT 5	MX
CV 1 PLUS GATE	SHIFT 7	CG
GATE REWRITE	SHIFT 8	GR
TUNE	SHIFT 9	TU
STEP and GATE	SHIFT 6 in (GATE ONLY)	SG
AVAILABLE MEMORY	SHIFT 0	AM
add a value	+(BACK)	+
subtract a value	--(FWD)	-
The following also use the <b>SHIFT</b> function but will be shown as <b>two functions</b> for clarity.		
transpose	SHIFT COPY	SHCP
increment channel #	SHIFT FWD	SHFW
decrement channel #	SHIFT BACK	SHBK
set/reset place marker	SHIFT ENTER	SHEN
insert MEAS END	SHIFT MEAS END	SHME
The following are used in <b>PLAY mode</b> . (mode down to PLAY)		
TOTAL TIME	TOTAL TIME (BACK)	TT
STEP ERROR	STEP ERROR (FWD)	SE
The following are used in <b>CASSETTE MEMORY TRANSFER mode</b> . (mode down to CMT)		
SAVE program	SAVE (7)	SV
VERIFY program	VERIFY (8)	VF
LOAD program	LOAD (9)	LD

### 3E: THE MC-4 PROGRAM SHEET

At this point, we will introduce the MC-4 **program sheet**. Until you have **total** familiarity with the programming of the MC-4, it will be necessary to keep track of the list of entries on a properly structured **program sheet**. The **program sheets** which are supplied by ROLAND are laid out as follows:

#### PROGRAM SHEET LAYOUT

- 1: It is ruled out in columns, from top to bottom.
- 2: The two left columns indicate **measure #**, and **step #**.
- 3: There are four **channel** columns, from left to right.
- 4: There are four columns under each **channel** heading:

CV1 CV2 ST GT

- 5: There is a blank space at the first line of each measure, which will sometimes have **BOLD PRINT**, as used in **chan 1 meas 1**.

TB 48 ME > > > > .

We call this a **command line**. This is used to indicate **editing commands**, as well as changing **default** values.

- 6: At the end of each measure, there is a horizontal line across the page, which indicates **MEASURE END**. This is followed by the next **measure #** in the left hand column.

- 7: The numbers indicated under each channel heading, are the values to be entered on the MC-4 keyboard.

I.E; In CHAN 1, CV 1, at MEAS 1, STEP 1, type 33 ENTER.

- 8: At the **last entry** of each measure, in the CV 1 column, type the number value followed by the **MEASURE END ME** key. The **ME** key is used instead of the **ENTER EN** key to tell the MC-4 to advance to the next measure.

If the data in the CV 1 column does not extend down to the **measure end line**, a **ME** appears under the last entry as a reminder to hit **ME** instead of **EN**. (As in **chan 1 meas 1 step 2**). **go directly to the NEXT MEASURE**.

- 9: If the data at the current step is the **same** as that of the previous step, **just hit** the **EN** key.  
I.E; Instead of typing **12 ENTER, 12 ENTER, 12 ENTER**, you can type **12 EN, EN, EN**. This is indicated by a **'** under the previous step. **REMEMBER:** The short form for **ENTER** may be written 2 ways; **EN** or **'** (comma).

- 10: The **'** has another meaning too. I.E; In CHAN 3, the **command line** reads:

2 CP , , , ME.

The MC-4 is pre-programmed with many **default values**. These are available to **simplify** the entry of **commonly used** or **obvious values**. In this example, we wish to **COPY** a part from **beginning** to **end**. Instead of entering the **begin** and **end** measures to be copied, or the **number of times** these are copied, use the ENTER '/' key to select the **default** values of the **COPY** function as follows:

In CHAN 3, COPY CHAN 2 from **beginning** 1st '/' to **end** 2nd '/' **one** time 3rd '/' **MEASURE**  
**END**.

### MUSICAL EXAMPLE FORMAT

- 1: **CHANNEL 1** is the melody line.
- 2: **CHANNELS 2 and 3** are the counterpoint lines.
- 3: **CHANNEL 4** is the bass line.
- 4: **For all four channels:**
  - CV 1** is **PITCH** information.
  - CV 2** is **DYNAMIC** information.
  - ST** is **TIME** value of the note.
  - GT** is the **SOUNDED** value of the note (phrasing).

### 3F: TIES and RESTS

**TIES** and **RESTS** are programmed in the **GATE TIME** memory.

The **STEP TIME** memory value determines the **time interval between notes**, while the **GATE TIME** memory value determines the actual **sounded duration** of the **note**, within the step time value.

A musical phrase may contain, for example, a series of 1/4 **notes**, each of which might have a **different phrasing** value. If the note is **staccato**, its **GATE TIME** value will be a **smaller** fraction of the step time value, than if the note's phrasing were **legato**, even though the **STEP TIMES** are **equal**.

MUSICAL EXAMPLE 3F-1:

TIME BASE J=48  
TEMPO=100-120

By Ralph Dyck

1 2 3

REPEAT 1, 2X

3 4

COPY 1, 2, 1X, = 4

5 6

COPY 5, 5, 1X, = 2

Continue to Next Page



7 COPY 6, 6, 1X, -2 8

Handwritten musical notation on four staves. The first staff has a treble clef and contains the text "COPY 6, 6, 1X, -2". The second and third staves have treble clefs and contain musical notation with slurs and accents. The fourth staff has a bass clef and contains musical notation with slurs, accents, and the text "REPEAT 3X".

**a: A TIE within a measure (EX. 3F-1a)**

is programmed by **adding up** the **STEP TIMES** of the notes contained within the **tie** and entering that value in the **STEP TIME** memory. The **GATE TIME** value is determined by the **sounded duration** of the notes within the tie.

This keeps the gate signal to the ADSR turned on for each tied note until the last note in the tie, when the normal duration value is in effect.

**b: A REST (EX. 3F-1b)**

is programmed by entering a value of '0' in the **GATE TIME** memory.

This turns off the gate signal to the ADSR.

**c: A series of RESTS within a measure (EX. 3F-1c)**

is programmed by **adding up** the **step time** values of the **note before** the **first rest** as well as the **rest's actual step time** value up to the **next sounded note**. This value is entered in the **STEP TIME** memory. The **GATE TIME** is determined by the **actual sounded duration** of the **note before the first rest**.



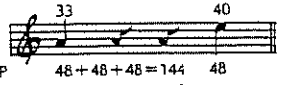
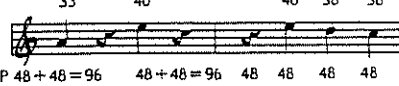
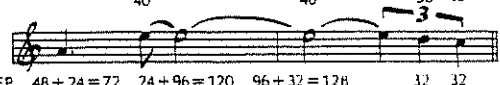
This causes the gate signal to turn on the ADSR for the sounded value, then turn off the ADSR for the remainder of the STEP TIMES till the next sounded note.

**d: When a REST ends a measure and begins the next measure (EX. 3F-1d),**

the **ending rest** is treated as normal, by giving the **GATE TIME** a value of '0' for the **ending rest**, and for the **rest beginning the next measure**.

**e: A TIE over a measure line (EX. 3F-1e)**

is programmed by entering the **same value** in the **GATE TIME** as was used in the **STEP TIME**. The following **GATE TIME** is the **normal sounded value** of the **remainder** of the **note in the next measure**.

<p><b>EX. 3F-1a</b> Tie within a Measure</p>	 <table border="0"> <tr> <td>STEP</td> <td>72</td> <td>24 + 96 = 120</td> </tr> <tr> <td>GATE</td> <td>70</td> <td>24 + 90 = 114</td> </tr> </table>	STEP	72	24 + 96 = 120	GATE	70	24 + 90 = 114	<p><b>EX. 3F-1b</b> Rest in a Measure</p>	 <table border="0"> <tr> <td>STEP</td> <td>48 + 24 = 72</td> <td>24 + 96 = 120</td> </tr> <tr> <td>GATE</td> <td>48 + 0 = 48</td> <td>24 + 90 = 114</td> </tr> </table>	STEP	48 + 24 = 72	24 + 96 = 120	GATE	48 + 0 = 48	24 + 90 = 114		
STEP	72	24 + 96 = 120															
GATE	70	24 + 90 = 114															
STEP	48 + 24 = 72	24 + 96 = 120															
GATE	48 + 0 = 48	24 + 90 = 114															
<p><b>EX. 3F-1c</b> Series of Rests in a Measure</p>	 <table border="0"> <tr> <td>STEP</td> <td>48 + 48 + 48 = 144</td> <td>48</td> </tr> <tr> <td>GATE</td> <td>48 + 0 + 0 = 48</td> <td>40</td> </tr> </table>	STEP	48 + 48 + 48 = 144	48	GATE	48 + 0 + 0 = 48	40										
STEP	48 + 48 + 48 = 144	48															
GATE	48 + 0 + 0 = 48	40															
<p><b>EX. 3F-1d</b> Rest ends a Measure &amp; Begins Next Measure</p>	 <table border="0"> <tr> <td>STEP</td> <td>48 + 48 = 96</td> <td>48 + 48 = 96</td> <td>48</td> <td>48</td> <td>48</td> <td>48</td> </tr> <tr> <td>GATE</td> <td>48 + 0 = 48</td> <td>48 + 0 = 48</td> <td>0</td> <td>40</td> <td>40</td> <td>40</td> </tr> </table>	STEP	48 + 48 = 96	48 + 48 = 96	48	48	48	48	GATE	48 + 0 = 48	48 + 0 = 48	0	40	40	40		
STEP	48 + 48 = 96	48 + 48 = 96	48	48	48	48											
GATE	48 + 0 = 48	48 + 0 = 48	0	40	40	40											
<p><b>EX. 3F-1e</b> A Tie over a Measure Line</p>	 <table border="0"> <tr> <td>STEP</td> <td>48 + 24 = 72</td> <td>24 + 96 = 120</td> <td>96 + 32 = 128</td> <td>32</td> <td>32</td> </tr> <tr> <td>GATE</td> <td>70</td> <td>24 + 96 = 120</td> <td>96 + 30 = 126</td> <td>30</td> <td>30</td> </tr> </table>	STEP	48 + 24 = 72	24 + 96 = 120	96 + 32 = 128	32	32	GATE	70	24 + 96 = 120	96 + 30 = 126	30	30				
STEP	48 + 24 = 72	24 + 96 = 120	96 + 32 = 128	32	32												
GATE	70	24 + 96 = 120	96 + 30 = 126	30	30												

### MC-4 PROGRAM SHEET

		CHAN 1				CHAN 2				CHAN 3				CHAN 4			
MES	STP	CV1	CV2	ST	GT	CV1	CV2	ST	GT	CV1	CV2	ST	GT	CV1	CV2	ST	GT
1		<b>TB</b>	<b>48</b>	<b>ME</b>		<b>RP,</b>				<b>2</b>	<b>CP</b>	<b>1,2</b>	<b>ME</b>				
	1	33	80	72	70	33	90	12	<b>SHCP</b>	29				7	90	36	32
	2	40	90	120	120	35	70		<b>SHCP</b>	31					80		
	3	(ME)				33	80			29					100	48	12
	4					35	70		<b>, , -2</b>	31				17	90	24	6
	5					36	80		<b>ME</b>	33	change				80	12	10
	6					38	90			35	CV 1 data			19	90	36	6
	7					36	80			33	only			(ME)			
	8					35	70			31							
	9					33	80			29							
	10					35	70			31							
	11					33	80			29							
	12					35	90			31							
	13					36	100			33							
	14					35	90			31							
	15					33	80			29							
16					31	70			28								
2	1			128		<b>RP SH2 SH1</b>								7	90	36	32
	2	38	70	32	30	<b>RP FW FW</b>									80		
	3	36	80			<b>SH4</b>									100	72	12
	4	(ME)				<b>FW</b>								8	70	24	
	5					<b>FW</b>								10	80		
3	1	34	90	72	70	<b>CP , , , -4 ME</b>				<b>CP , , , -4 ME</b>				<b>CP 1, 1, , 8 ME</b>			
	2	41	100	120	120												
	3	(ME)															
	4																
	5																
	6																
4	1	(ME)		192	188									15	90	36	32
	2														80		
	3														100	72	12
	4													10	80	12	
	5													12	70		
	6													13	80		
	7													15	90		10

5	1	33 90 72 70	33 90 12	2 CP 5,5 ME	19 90 36 32
	2	40 100 120 118	35 70 ,	29	, 80 , ,
	3	(ME)	33 80 ,	31	, 100 48 12
	4	FW FW FW SH1	35 70 ,	29 change	5 90 24 6
	5	SH4 SH2 SH3 FW	36 80 ,	31 CV1 data	, 80 12 10
	6		38 90 ,	33 only	7 90 36 6
	7		36 80 ,	35	(ME)
	8		35 70 ,	33	
	9		33 80 ,	31	
	10		35 70 ,	29	
	11		33 80 ,	31	
	12		35 90 ,	29	
	13		36 100 ,	31	
	14		35 90 ,	33	
	15		33 80 ,	31	
	16		32 70 ,	29	
			28		
6	1	CP 5,5, ,-2 ME	CP 5,5, ,-2 ME	CP 5,5, ,-2 ME	17 90 36 32
	2				12 80 , ,
	3				5 100 120 12
7	1	CP 6,6, ,-2 ME	CP 6,6, ,-2 ME	CP 6,6, ,-2 ME	15 90 36 32
	2				, 80 , ,
	3				, 100 48 12
	4				, 90 12 10
	5				10 80 , ,
	6				13 90 , ,
	7				15 100 36 6
8	1	28 80 192 176	31 90 12	2 CP 8,8 ME	RP,
	2	(ME)	30 70 ,	28	14 100 12 10
	3		28 80 ,	26	, 90 24 6
	4		30 70 ,	24	12 80 12 10
	5		31 80 ,	26 change	
	6		33 90 ,	28 CV1 data	RP
	7		31 80 ,	30 only	RP
	8		33 70 ,	28	3, use FW and
	9		35 80 ,	30	SH# keys
	10		36 70 ,	31	
	11		35 80 ,	33	14 90 48 36
	12		36 90 ,	31	(ME)
	13		38 100 48 [32]	33	
			35		

### 3G: PROGRAMMING INSTRUCTIONS for CHANNEL 1

COMMAND	DISPLAY
1: Power on.	TB 120 30 15
2: Change TB value to 48.	TB 48 <sub>L</sub>
3: Press ME.	TEMPO 100 <sub>L</sub>
4: CURSOR RIGHT 4X > > > >	1 1 1 <sub>L</sub>

Having typed the first **command line** from the **program sheet**, the display on the MC-4 shows:

**CHAN 1, MEASURE 1, STEP 1, —**

The '—' indicates that the MC-4 is waiting for an entry in the CV 1 mode. (See **SHIFT MAP**.)

5: From the <b>program sheet</b> , enter CV 1 data for <b>measures 1 to 5</b> . The display should now show:	1 6 1 —
---	---------

Before entering CV 1 values in **measure 6**, enter CV 2 values for **meas 1 to 5**.

6: Press <b>FW</b> (loop to beginning).	1 1 1 33
7: <b>SH4</b> (for CV 2 entry).	1 1 1 50
8: Enter CV 2 data for MES 1 to 5. (MC-4 will <b>beep</b> !)	
9: Press <b>FW</b> ( <b>beep</b> ).	1 1 1 80
10: Press <b>SH2</b> .	1 1 1 30
11: Enter <b>ST</b> data for MES 1 to 5 ( <b>beep</b> ).	
12: Press <b>FW</b> ( <b>beep</b> ).	1 1 1 72
13: Press <b>SH3</b> .	1 1 1 15
14: Enter <b>GT</b> data for MES 1 to 5 ( <b>beep</b> ).	

With all of the information successfully entered in the first five measures, you are now ready for the first **editing command**.

15: At this point press <b>SH1</b> , then <b>FW</b> . The CV 1 LED will be ON.	1 6 1 —
---	---------

16: <b>COPY with transpose</b> . At MES 6, the <b>command line</b> reads: This means: <b>COPY MES 5</b> from <b>beginning</b> to <b>end one</b> time and <b>transpose down two semi-tones</b> .	CP 5, 5,, —2 ME
---	-----------------

CP 5 EN 5 EN EN —2. Then <b>ME</b> .	05,5,,—2 <sub>L</sub> 1 7 1 —
---	----------------------------------

17: Now, repeat the process at MES 7 STP 1.

CP 6 EN 6 EN EN -2.  
ME.

06.6.1.-2L  
1 8 1 -

The **copy and transpose** command copied all of the data in MES 6, and transposed the pitch down two semi-tones. In MES 7, the pitch will be four semi-tones lower than in MES 5, because it transposed down from MES 6.

18: Now, to finish with the **CHAN 1** entries, enter the data for MES 8.

Enter **CV1** data for MES 8.

1 9 1 -

19: Step **BK** to MES 8 STP 1.

1 8 1 28

20: **SH4** and enter **CV2** data for MES 8.

1 8 1 80

21: **SH2** and enter **ST** data for MES 8.

1 8 1 192

22: **SH3** and enter **GT** data for MES 8.

1 8 1 176

### 3H: PROGRAMMING INSTRUCTIONS for CHANNEL 2

	<u>COMMAND</u>	<u>DISPLAY</u>
1:	Press <b>RP EN</b> . This is the <b>opening repeat marker</b> .	2 1 1 ( (key down) 2 1 2 - (key up)
2:	Enter <b>CV 1</b> data for MES 1.	
3:	Press <b>RP RP EN</b> .	2 2 1 ) 2 (key down)
	This is the <b>closing repeat marker</b> , which will <b>repeat mes 1</b> a <b>default</b> value of <b>two times</b> .	2 3 1 - (key up)
	This means that the MC-4 will play <b>measure 1 twice</b> , so the next data should be entered for <b>measure 3</b> , not for <b>measure 2</b> .	
4:	Press <b>SH4</b> (beep) <b>FW</b> (beep) <b>FW</b> . These commands change the assignment to <b>CV 2</b> , then to <b>MES 1 STP 1</b> , by <b>skipping</b> over the <b>repeat markers</b> .	2 1 1 50
5:	Enter <b>CV 2</b> data for MES 1.	
6:	Press <b>SH2</b> then <b>FW FW</b> .	2 1 1 30
7:	Enter <b>ST</b> data for MES 1.	
8:	Press <b>SH1</b> then <b>FW</b> .	2 3 1 -
9:	Press <b>CP EN EN EN -4</b> . <b>ME</b> .	0,,-4 2 5 1 -
	This function <b>copied all</b> of <b>MES 1 including repeats</b> . Note that <b>GATE TIMES</b> are <b>not entered</b> at this time!	
10:	Enter <b>CV 1</b> data for MES 5.	
11:	Step <b>BACK</b> to MES 5 STP 1.	2 5 1 33
12:	Press <b>SH4</b> .	2 5 1 50
13:	Enter <b>CV 2</b> data for MES 5.	
14:	Step <b>BACK</b> to MES 5 STP 1.	2 5 1 90
15:	Press <b>SH2</b> .	2 5 1 30
16:	Enter <b>ST</b> data for MES 5.	
17:	Press <b>SH1</b> then <b>FW</b> .	2 6 1 -
18:	Press <b>CP 5 EN 5 EN EN -2</b> . <b>ME</b> .	05,5,,,-2 2 7 1 -
19:	Press <b>CP 6 EN 6 EN EN -2</b> . <b>ME</b> .	06,6,,,-2 2 8 1 -
20:	Enter <b>CV 1</b> data for MES 8.	

21:	Step <b>BACK</b> to MES 8 STP 1.	2	8	1	31
22:	Press <b>SH4</b> .	2	8	1	50
23:	Enter <b>CV 2</b> data for MES 8.				
24:	Step <b>BACK</b> to MES 8 STP 1.	2	8	1	90
25:	Press <b>SH2</b> .	2	8	1	30
26:	Enter <b>ST</b> data for MES 8.				
27:	Press <b>FW FW</b> .	2	1	1	12
28:	Press <b>SH3</b> .	2	1	1	12

At this time, notice the instructions in the **GT column**. These will **COPY** the **ST** data for the **entire** piece **less** a value of **TWO**. This is an **easy** way of programming **GATE TIMES** with only **one** type of **phrasing**. (in this case, **legato**)

29:	Press <b>SHCP SHCP EN EN — 2</b> .	TT,,-2			
	<b>ME</b> .	2	8	13	46
30:	Press <b>32 EN</b> .	2	8	13	32

This completes the entries for **channel 2**. Go to the **PLAY** mode and **listen** to the **two parts**, and **correct any errors** by returning to the **EDIT** mode.



### 3I: PROGRAMMING INSTRUCTIONS for CHANNEL 3

1:	Return to the <b>EDIT</b> mode and <b>SHFW</b> to select CH 3. The display will <b>default</b> to CV 1.	3	1	1	-	
2:	Press 2 <b>CP 1 EN 2 EN ME</b> . These commands <b>copied</b> the data from CH 2, MES 1 & 2.	3	3	1	-	
3:	Press <b>FW FW</b> and enter CV 1 data for CH 3 MES 1.					
4:	Press <b>EN</b> or <b>FW</b> to skip repeats.	3	3	1	-	
5:	Press <b>CP EN EN EN — 4</b> . <b>ME</b> .	C...-4	3	5	1	-
6:	Press 2 <b>CP 5 EN 5</b> . <b>ME</b> .	C5,5	3	6	1	-
7:	Step <b>BACK</b> to MES 5 STP 1.	3	5	1	33	
8:	Enter CV 1 data for MES 5.					
9:	Press <b>CP 5 EN 5 EN EN — 2</b> . <b>ME</b> .	C5,5...-2	3	7	1	-
10:	Press <b>CP 6 EN 6 EN EN — 2</b> . <b>ME</b> .	C6,6...-2	3	8	1	-
11:	Press 2 <b>CP 8 EN 8</b> . <b>ME</b> .	2C8,8	3	9	1	-
12:	Step <b>BACK</b> to MES 8 STP 1.	3	8	1	31	
13:	Enter CV 1 data for MES 8.	3	9	1	-	

Steps 3 to 13 are using a variety of **time saving commands** which **simplify** programming.

See **APPENDIX A-6** for details.

### 3J): PROGRAMMING INSTRUCTIONS for CHANNEL 4

- 1: Press **SHFW** and **display shows:** 4 1 1 -
- 2: Enter **CV 1** data for MES 1 to 2.
- 3: Using the functions described in the previous sections, enter **CV 2, ST & GT** data for MES 1 & 2.
- 4: Select **CV 1 MES 3 STP 1** and enter **command line** from the **program sheet**.
- 5: Enter **data** for **CV 1, CV 2, ST & GT** for MES 4 to 7. By now, the **pattern of keystroke commands** should be **obvious**.

If **problems** arise, **clear the channel** by **cursoring left 2 times ' < < '**, and **press DL EN EN ME**. Sometimes it is easier to start all over than to fix up a series of errors.

**Verify each entry** with the **program sheet!** If all is OK to here, then proceed to step 6.

- 6: In **CV 1**, press **RP EN** and enter **data** for **STEPS 1 to 3**.
- 7: Press **RP RP 3 EN**.  
This will **repeat a phrase** within the measure.
- 8: Enter **CV 1** data for **STP 10** and **ME**.
- 9: Enter **CV 2, ST & GT** data for **MES 8**.

**Remember to step BACK** and use the **EN** or **FW** keys to **skip over repeat makers!**

### 3K: EDITING and PLAYING THE MULTI-VOICE PROGRAM

Before going into the **PLAY** mode, take a few minutes to check your entries to those in the **program sheet**. While still in the **EDIT** mode, use the **BACK (BK)** and **FWD (FW)** keys to step through the data. While doing this, it will be necessary to make use of the **channel change modes**, (**SHFW** to go 1, 2, 3, 4) and (**SHBK** to go 4, 3, 2, 1). If you detect an error in any of the **CV 1**, **CV 2**, **ST**, or **GT** functions, then make use of the following additional **editing** keys on the MC-4.

#### The **INSERT** and **DELETE** keys

**a:** In the case of a **missed entry**, use the **INSERT** key. Use the **BK** or **FW** keys to **position** the MC-4 **mes** and **stp** display to the **STEP after** the missed entry. The **INSERT** function will **push** a key value between the **previous step** and the **current step**. Use the following example as guide:

**Missing step in CHAN 2, MES 5, STP 4, CV 1.**

Using the **BK** or **FW** keys, step to the 4th entry in **CV 1**. If the missing entry is, for example **CV 1** value '35', then the next value in the list would show up instead: **CV 1 = '36'**.

Press **INSERT (IN)**, '35', **EN**. This will **insert** the new correct value for **CV 1** into **STP 4, MES 5**.

**b:** The **DELETE** key is used in a similar way, but with the opposite function. If **MES 5, STP 4** of **CHAN 2** was accidentally entered twice, then that measure would have one **extra** note, (**17** instead of **16**). Step to the entry to be deleted in **CV 1** and press **DELETE (DL)** **EN**. This will remove the extra note and take up the slack in that measure, giving it the correct number of steps: (**16**).

**c:** In the case of a **missing MEASURE END**, find the note that is supposed to be the start of the measure, (in **CV 1** mode), and press **INSERT** then **ME**, or **SHIFT ME**.

**These problems should really make themselves known at the time of entering the data the first time through!**

It pays to observe the readouts and **verify** the data being entered against the data on the **program sheet**.

#### **NOTE:**

The **INSERT** or **DELETE** keys are used for **CV 1 editing only**. If **INSERT** or **DELETE** is attempted in any other function memory, the MC-4 will ignore the command and beep to indicate an illegal function.

Because CV 1 is the **master** and the **other function memories** are the **slaved**, their positions will open up to allow you to fill them in with the correct value by simply **stepping back**, changing to the other modes on the **SHIFT MAP** and entering the correct values.

The **other function memories** will temporarily be filled with **default values**, such as '50' for CV 2, '30' for ST, and '15' for GT. This clever bit of programming, built into the MC-4, was carefully thought out to cover such a possibility.

## STEP TIME ERRORS

Assuming all is OK and all of the data is in order, then press the **MODE** key once to enter the **PLAY** mode.

Set the **TEMPO** control to halfway and press **ENTER** which is now the **START** key. Listen carefully for any obvious **pitch errors** and correct them by returning to the **EDIT** mode with the **MODE** key. Also to correct a **STEP** or **GATE** or CV 2 error, go back to the **EDIT** mode and find the wrong value and simply change it.

**Step time errors** are easy to detect if there is a **large error**, but are very subtle if they are small. Press **ME** to **STOP** the MC-4 and check each channel for **step time errors** by pressing the **STEP ERROR** key, which is the third function for the **FWD** key (while still in the **PLAY** mode).

The display will show the **error channel** and **measure** and the amount of **error** as '+' or '-' **value**, to make it easier to find the wrong step time value. If a step error is found in channel 4 by pressing the **STEP ERROR** key, then you can go back to the **EDIT** mode **directly**, and the display channel will change to channel 4, allowing correction of the error value.

### NOTE:

If there is a step error in **channel 1**, and other channel data are correct in the same measure, step errors may be detected in **channels 2, 3, 4**.

By now the **4 voice example** should be playing perfectly and will be ready to save on tape, so that it may be **loaded** in at any time in the future.

### 3L: SAVING and VERIFYING the MULTI-VOICE EXAMPLE

Follow the same procedures as in **CHAPTER TWO** for **saving, verifying** and **loading**.

Try **saving** the program with different **file names** and also try **saving** 1 or 2 channels **only** by following the file name with **EN** and any combination of 1—2—3—4: E.G;

**SV 123,24 ME.**

This will **SAVE** the program as **file name 123** and **channels 2** and **4 only**.

### 3M: SUMMARY OF CHAPTER THREE

By this time, you should be getting quite used to the functions and keystrokes on the MC-4, but the only way to gain real expertise and confidence is to **practice carefully**, just as a music teacher would have you do, because the basic fact about the MC-4 is that it is a **musical instrument**.

The next chapter deals with **live keyboard entry** and the following chapters explore the **key functions** in detail.

The **APPENDIXES** are used as reference for the functions which are too lengthy and involved to explain in the opening chapters.

## CHAPTER FOUR

# LIVE KEYBOARD PROGRAMMING

### 4A: INTRODUCTION

This chapter is for those of you who wish to program the MC-4 in **real time**, with a **synthesizer keyboard**.

The pre-programmed values [**DEFAULT VALUES**] make this a very simple process. With just a few keystrokes, you are ready to enter your musical masterpieces into the MC-4's memory.

Before continuing with this chapter, examine the **fold out keyboard layout** of the MC-4 front panel. Familiarize yourself with the **keyboard layout** and the **keystrokes** used in this chapter which are as follows:

- 1: **CURSOR RIGHT (>)**
- 2: **CURSOR LEFT (<)**
  
- 3: **SHIFT MAP FUNCTIONS**
  - a) **SHIFT 7** = **CV 1 + GATE** (LIVE ENTRY mode)
  - b) **SHIFT 8** = **GATE REWRITE** (LIVE ENTRY mode)
  - c) **SHIFT 1** = **CV 1 MODE** (EDIT mode)
  - d) **SHIFT + or -** = (change channels)
  
- 4: **ENTER key** = **also START in PLAY mode**
- 5: **MEASURE END key** = **also STOP/CONT in PLAY mode**
- 6: **BACK/FORWARD STEP key** = **also + or -**
  
- 7: **MODE switch** = **EDIT & PLAY**

When using any of the **SHIFT** functions, hold down the **SHIFT** key, then press the **number** on the **calculator keyboard** at the same time.

## DEFAULT VALUES

The **default values** are pre-programmed into the MC-4's memory to simplify the operating procedure. The **default values** and **default functions** used in this chapter are;

### 1: TIME BASE, STEP TIME and GATE TIME

The **default time base** values are discussed in **CHAPTER 1**, and detailed in **APPENDIX A**. It is not necessary to explain them at this time. At **power on**, the **DISPLAY SHOWS**:

```
TE 120 30 15
```

### 2: CV 1 LED ON (small red light on SHIFT MAP display)

This indicates that the MC-4 is in CV 1 mode which is a **default** function. The MC-4 will **always** be in this mode when first **powered on**.

### 3: EDIT MODE (LED under calculator keypad)

This LED indicates that the MC-4 is in the **EDIT** mode and is ready to accept **entries** from the **synthesizer keyboard** or the **calculator keyboard**.

### 4: CHAN 1 MEASURE 1 STEP 1

Press **CURSOR RIGHT** five times > > > > > after **power on**, and the **display** will advance to **CHAN 1, MEAS 1, STEP 1**, automatically, and **show**:

```
1 1 1 -
```

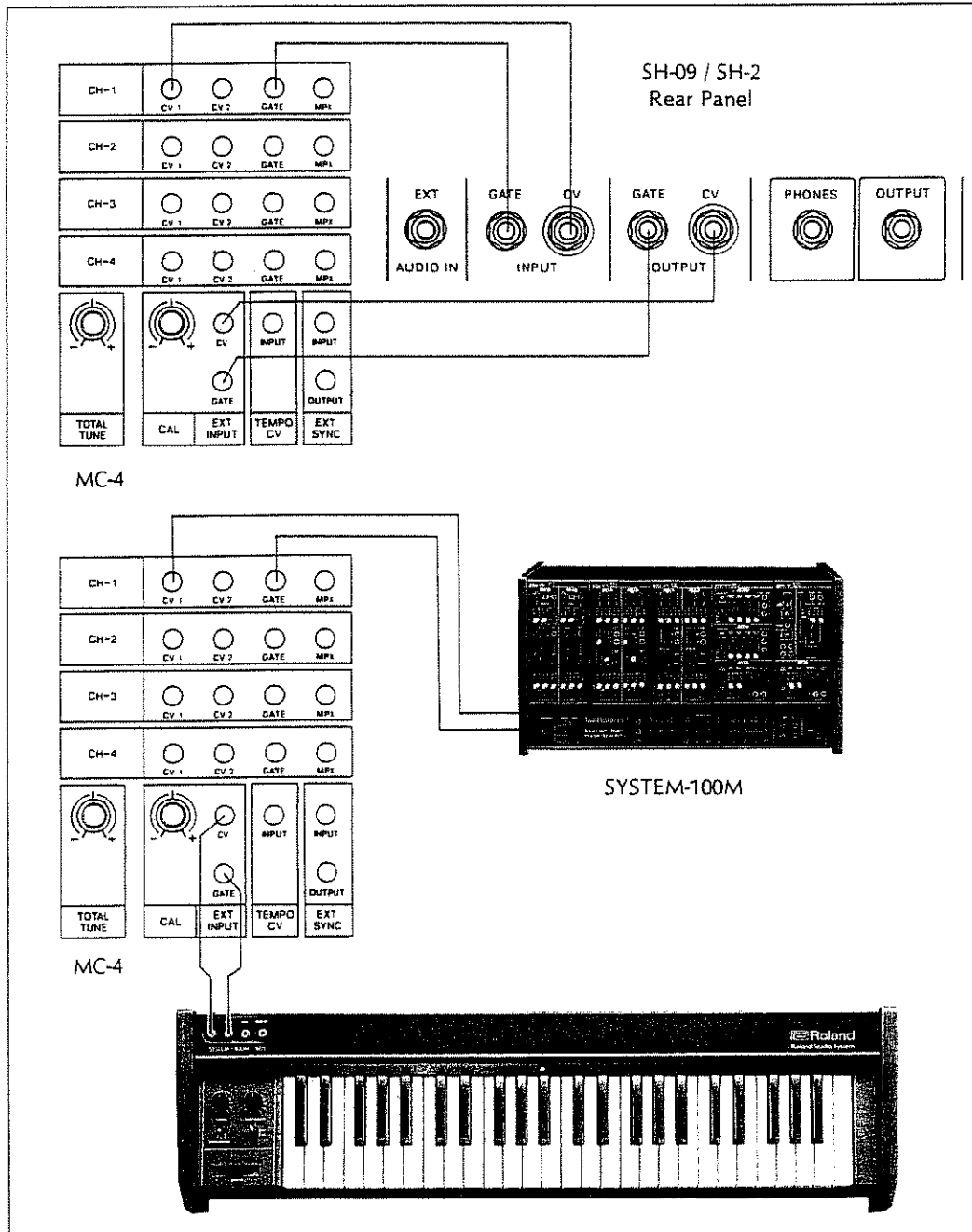
### 5: TIME SIGNATURE

The **default** time signature is **4/4 time**.

## 4B: HOOKUP FOR EXTERNAL SYNTHESIZER KEYBOARD

With the system hooked up as explained, you are now ready to start programming. Start by entering a single voice musical piece using **CHANNEL ONE**.

DIAGRAM 4B-1:





#### 4C: PROGRAMMING INSTRUCTIONS for LIVE KEYBOARD ENTRY

1: **Power on.**

Display shows:

TB 120 30 15

(CV 1 and EDIT leds on)

2: **CURSOR RIGHT 5 TIMES > > > > > .**

Display shows:

1 1 1 -

(CHAN 1, MEAS 1, STEP 1)

The '-' indicates that the MC-4 is **waiting** for an entry.

3: **Press SHIFT 7.**

Display shows:

(CV 1 + GATE mode)

1 1 1 CU+G

This puts the MC-4 in the **live keyboard** entry mode.

4: **Press ENTER.**

The MC-4 has a **built-in metronome** which will **beep 8 times to count in the starting measure.** **Any time after the 8 beats,** you may start playing the synthesizer keyboard.

Notice, as **each key** of the synthesizer is struck, the display will **increment the step counter,** and at the **end of each 4 beats,** will **increment the measure counter.** When finished playing, go to step 5.

5: **Press MEASURE END.**

You will hear the **metronome beep** to the **end of the measure,** then **stop.**

That's **all** there is to it!

**Just POWER ON.**

**CURSOR RIGHT** until the display shows **CHAN 1, MEAS 1, STEP 1.**

**SHIFT 7** into the **CV 1 + GATE mode.**

**Press ENTER.**

**Wait 8 beats, and start PLAYING!**

6: **Select PLAY mode,** and listen to the **program.**

Press down on the **MODE switch** 1 time, and the display will show:

1 1 1 PLAY

7: Press **START (ENTER)** to start playing the program, and press **STOP (MEASURE END)** to stop.

If you press the **STOP** key before the end of the piece, the MC-4 will **stop** at that point, and by pressing the **STOP** key again, it will **continue** to play from that point. Push the **CYCLE switch** to the **ON** position, and the piece will **repeat** until you push the **STOP/CONT** key.

**8: Change the TEMPO of the piece.**

This is done by turning the **TEMPO control knob** to the left and right of the center position.

**9: Return to EDIT mode.**

Press **SHIFT 1**, and the LED in the **SHIFT MAP** will indicate **CV 1 mode**. The display will show the **current channel, measure, and step**. If you are at the **end of the program**, the display will also indicate '—', which means that the MC-4 is waiting for more entries.

**10: Step through the program.** This is done by pressing the **BACK** or **FORWARD (FWD)** keys.

**11: Press SHIFT 7.**

If the display shows: NOT END  
the MC-4 is remaining you that it is **not at end** of the current program. This will help prevent accidental insertions, because the MC-4 is capable of inserting new entries anywhere in the program.

**12: SAVE the program.**

Follow the instructions in **CHAPTER 2** to **SAVE** the program on cassette tape.

Before moving on to **multi-voice programming in live keyboard mode**, repeat the steps in this section of the chapter until you become comfortable with the procedures for single-voice programming. Try loading different types of music, to get the feel of the synthesizer keyboard when it is patched to the MC-4. You may find that the sensitivity is different than when using your synthesizer by itself.

**NOTE:**

When **each key** is struck, and the display is **erratic**, this could be due to improper keyboard tuning or to "chatter" from dirty key contacts. Keyboard tuning is easily accomplished by adjusting the calibration knob to the left of EXT INPUT on the MC-4 panel, or by adjusting the tuning knob on the synthesizer keyboard. The display should show the same values as on the numbered keyboard below in **diagram 4C-1** (page 49). If problems persist, then inquire at your nearest ROLAND service center.

To delete unwanted entries, **CURSOR LEFT 3 times <<<**, press **DL BK**. This clears all of the data. Go to step 3.

Display will show:

1 1 1 CV+6

## 4D: MULTI-VOICE PROGRAMMING for LIVE KEYBOARD MODE

Essentially, the **multi-voice programming** procedure is the same as **single-voice programming**, but here is something to keep in mind:

Be very careful with the hookup. You may even find it helpful to label the patch cords for the appropriate CVs, **gates**, and **channels**, and make note to which VCO, CV 1 is patched. It could save some wire tracing later on.

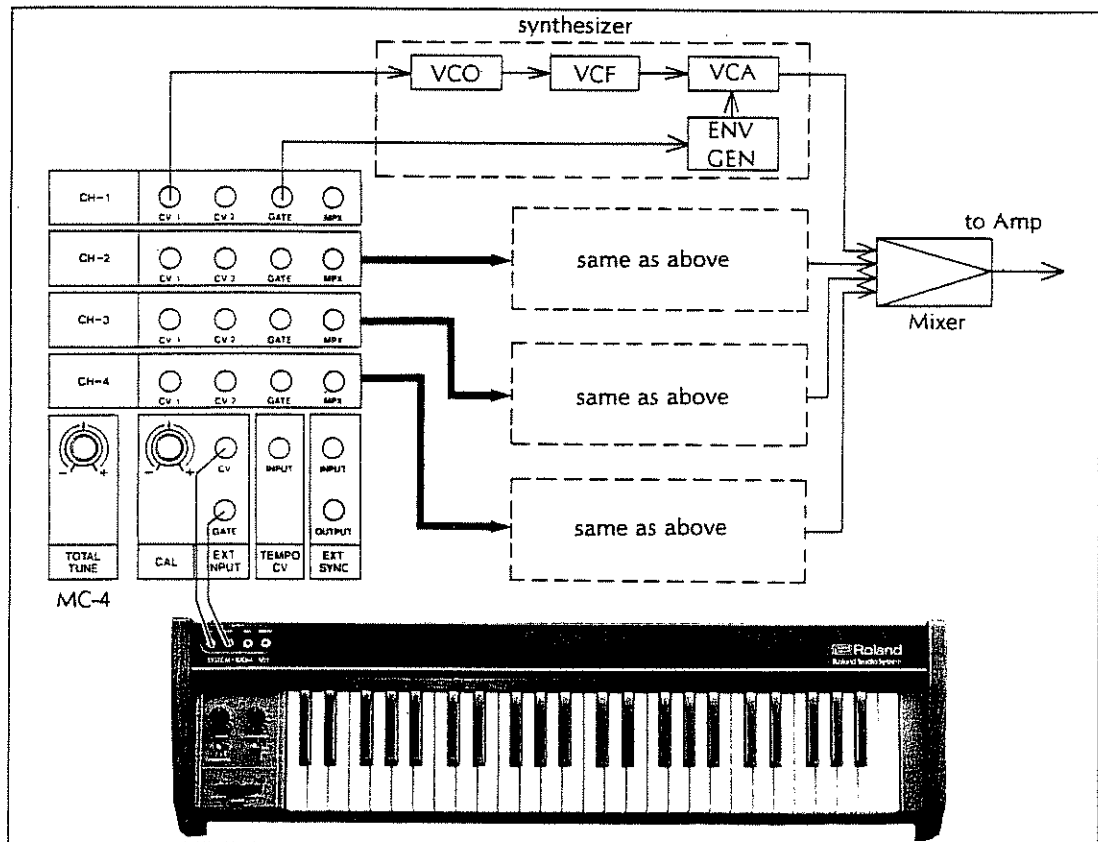
For this program, try playing the enclosed **4 voice example** for **external keyboard entry**. (If reading music is not your forte, then make up a simple 8 bar tune, in 4/4 time using 3 or 4 voices.

### MULTI-VOICE PATCHING

Assuming that a **3 or 4 voice synthesizer** is available, use the same patch as in **DIAGRAM 4B-1**, except that you will have to **add** extra patch cords to connect the **remaining voices** to **channels 2, 3 & 4** of the MC-4.

These examples will work quite well using **two single-voice synthesizers** and **programming parts 1 & 3** of **musical example 4D-1**.

### DIAGRAM 4D-1: MULTI-VOICE HOOKUP for LIVE MODE



MUSICAL EXAMPLE 4D-1: 4 VOICE EXAMPLE, LIVE KEYBOARD ENTRY

By Ralph Dyck

8va TILL END

The first system of the musical score consists of four staves. The top staff is a vocal line with a long melisma line above it. The second staff is a keyboard accompaniment line with a melisma line above it. The third staff is a keyboard accompaniment line with a melisma line above it. The fourth staff is a keyboard accompaniment line. The key signature is one sharp (F#) and the time signature is 4/4. The system is divided into two measures by a vertical bar line.

The second system of the musical score consists of four staves. The top staff is a vocal line with a melisma line above it. The second staff is a keyboard accompaniment line with a melisma line above it. The third staff is a keyboard accompaniment line with a melisma line above it. The fourth staff is a keyboard accompaniment line. The key signature is one sharp (F#) and the time signature is 4/4. The system is divided into two measures by a vertical bar line.

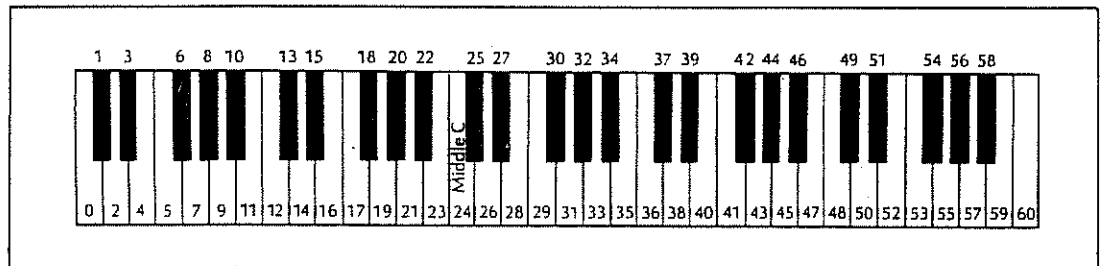
The third system of the musical score consists of four staves. The top staff is a vocal line with a melisma line above it. The second staff is a keyboard accompaniment line with a melisma line above it. The third staff is a keyboard accompaniment line with a melisma line above it. The fourth staff is a keyboard accompaniment line. The key signature is one sharp (F#) and the time signature is 4/4. The system is divided into two measures by a vertical bar line.

Continue to Next Page



**NOTE:** Line #3 (All sixteenths) should be CV 1 entry only except last note by entering ST value of 240, GT value of 200.

**DIAGRAM 4C-1:**



## MULTI-VOICE PROGRAMMING INSTRUCTIONS

Remember to **power on**, **CURSOR RIGHT 5 times >>>>>**, and **select CV 1+GATE mode**. The MC-4 is now **ready to be programmed with part one of the multi-voice example 4D-1**.

**1: Press 4 ENTER 8 MEAS END.**

The MC-4 will **beep 8 times (2 measures)** as a **count-in**. The commands entered will **set 4/4 time** and the MC-4 will **allow 8 measures** to be played, then it will stop.

**2: Play the first part for 8 measures.**

**3: Go to PLAY mode, press START and check for errors!**

**4: Return to EDIT mode** by pushing **MODE switch** down twice.

**5: Go to CHANNEL 2 (press SHIFT FWD).**

The display should now show:

2 1 1 -

**6: Enter second part of musical example.**

Press **4 ENTER 8 MEAS END** and the metronome will give the **eight beat count-in**. You will **hear the part in channel 1 while playing the second part in channel 2**.

**7: Go to the PLAY mode and check for errors while playing the program.**

This is the basic method for **multi-voice programming**. Again, repeat these steps until you feel comfortable with the procedure, and repeat the experiments with the **tempo, stop/continue** as in **section 4A**.

If you wish to enter a three or four part piece of music, just repeat the steps in this section, but remember to play each channel before entering the next one, and don't forget to **SHIFT** to the correct **channel number** before loading the third and fourth voices.

Unless you have perfect playing technique, a few small **errors** crept into your program. These may be corrected very easily using the **EDIT functions** described in the **next section**.

## 4E: EXPANDED FUNCTIONS for LIVE KEYBOARD PROGRAMMING

Now that you have reached this point with the MC-4's **live entry mode**, have a look at the **expanded editing functions** on the MC-4. Before going any further, make sure that you fully understand the procedures in the previous sections of this chapter.

Even though you may not be interested in the **calculator keyboard entry mode** programming, it is **advisable to go through CHAPTERS ONE and THREE** before getting into this section of the **live entry mode**. You will find it helpful to understand the **basic editing functions** detailed in **CHAPTER 3**, as you will use the same **commands** in this section.

For the **expanded functions** in the **live keyboard mode**, enter the music using **CV 1+GATE**, then go to the **CV1** mode to use the **calculator keyboard** for **editing** the data in memory.

### EXPANDED COMMANDS

1: GATE REWRITE (SHIFT 8)	4F:
2: COPY	4G:
3: COPY with TRANSPOSE / TRANSPOSE only	4G-2:
4: COPY CHANNEL to CHANNEL	4G-5:
5: REPEAT	3H: A-6:
6: Correct PITCHES / INSERT / DELETE	3K:
7: Changing DEFAULT TIME SIGNATURE	4H:
8: Entering specified number of MEASURES	4H:
9: Changing DEFAULT TEMPO VALUE	4I:

## 4F: GATE REWRITE

The **GATE REWRITE** function may be used in **two** different ways. These are:

a) **To correct (edit) timing errors** which may have happened while using the **CV 1 + GATE** mode.

Suppose that **all** of the **pitches** entered the first time were **OK**, but the **timing**, or **phrasing** was not as you would like it. Using the **GATE REWRITE** mode, the **timing & phrasing** may be **re-entered** without having to enter the **pitches** again.

This is done by **tapping any key** on the synthesizer keyboard, **in time** with the **beat (beep)**, while in this mode. This will **re-enter** new timing & phrasing without changing the **original pitches**.

b) **To enter pitches, out of tempo**, by using **CV 1** mode, and **carefully** pressing each key in turn, **to insure accuracy in difficult passages**. Then use **GATE REWRITE** to enter the **timing & phrasing** by **tapping the rhythm** for each note, **in tempo**. This may be done at a **slow tempo**, which may be **speeded up later** to the **proper tempo**. This is the **most valuable** function in the **live keyboard entry mode!!**

The first thing is to enter a short melody in **CHAN 1** of the MC-4. **This may be done in either the CV 1 mode, or the CV 1 + GATE mode.**

To enter the **pitches** in the **CV 1** mode, the **procedure is very simple:**

1: **Go to CHAN 1, MEAS 1, STEP 1, in CV 1 mode.**

2: **Play the notes in the melody in order**, but do not worry about playing **in tempo**. The MC-4 will remember the **pitches only** at this time, and the **timing** will be **added** later using the **GATE REWRITE** mode.

Note that the **measure** number does not advance. Only the **STEP** number advances. If there are 24 notes in the melody, the **display will show:**

1	1	25	-
---	---	----	---

**CHAN 1, MEAS 1, STEP 25...**

Now that the pitches are entered into **CHAN 1**, you may **write the time values**, using the **GATE REWRITE** function.

3: **Go to CHAN 1, MEAS 1, STEP 1.**

4: **Press SHIFT 8 (gate rewrite mode).**



- 5: **Press ENTER.**  
The metronome on the MC-4 will give the **8 beat count-in**. Simply tap out the desired time values on any key of the synthesizer keyboard.
- 6: **At the end of the piece, press MEASURE END.**  
The metronome will sound to the end of the current measure, and then stop.
- 7: **Switch to the PLAY mode.**  
Press the **MODE** switch down, and the display show:           1   1   1 PLAY
- 8: **Press START**, and the piece will play with the new **STEP and GATE TIME values**.  
Notice that the **MEASURE** number, as well as the **STEP** number advances when you enter the time values in the **GATE REWRITE** mode.

The **default time signature** for **GATE REWRITE** mode is **4/4 time**. After counting four beats, the MC-4 advances to the next measure.

We will show how to **change** time signatures later in **this chapter**.

**NOTE:**

The **gate timing** may also be edited in **ST and GT** mode using the **calculator keyboard** on the MC-4. This way is another useful and **very fast method** to enter music into MC-4.

For details, see **CHAPTER ONE [1B: 1D-4:]**.

## 4G: COPY FUNCTIONS

The first use of the **COPY** function will be to copy data **within a channel**.

If **CHAN 1** has an **8 bar program** in memory, then it may be **copied as many times as required**, up to the **limit** of the MC-4 memory capacity.

### NOTE:

This is **wasteful** of memory, because the **REPEAT** function may be better suited for this purpose.

The **REPEAT** function is detailed in **CHAPTER THREE**.

This use of **COPY** is **very handy** when a part must be repeated several times, and **small note or timing changes** are desired in each of the **copied sections**. This way, **only the changes** have to be **edited**, which eliminates **re-entering the entire part each time**.

**For example: Copy 8 bars 3 times for a total of 32 bars.**

**1: Enter an 8 bar phrase in CV 1 + GATE.**

At the end of the piece, the display will show:

1 9 1 CV+G

The CV+G indicates that MC-4 is waiting for more entry. Before **copying** the data, the MC-4 must be in CV 1 mode.

**2: Press SHIFT 1 (to get to CV 1 mode).**

The display should show:

1 9 1 -

**3: Press COPY ENTER ENTER 3 ENTER**

Then **MEAS END**.

The display should now show:

0, 3, 1

1 33 1 -

This shows that it has copied **measures 1-8, 3 times** which gives a total of 32 measures, and the MC-4 is waiting for an entry at the beginning of **measure 33**.

**4: Play the program** The MC-4 will play the 32 bars and then stop.

For details of the **COPY** function, see **APPENDIX A-6**.

## 4G-2: COPY WITH TRANSPOSE

As intimated, the copy with transpose function copies the data, and transposes it up or down a specified number of intervals. The command is the same as the **normal COPY** function. The MC-4 must be **in the CV 1 mode to copy**. You will encounter another **default function** using this command. The MC-4 assumes that it will **transpose up** unless it is told to **transpose down**.

At this time, we will introduce the usage of **abbreviations** for the names of each of the **key-stroke** commands. This will make reading a long **command sequence** much easier.

**For example:** EN = ENTER, ME = MEASURE END. Refer to the foldout at page 24~25.

The command reads: **Copy from beginning to end one time and transpose up five semi-tones.**

The short form is:

CP EN EN EN 5 ME

Display shows:

C P EN EN EN 5 ME (before ME)

To get started, enter the eight bar figure as in **section 4D**. Remember to **return to CV 1 mode** before using the **COPY function**. Be sure to enter the **COPY** command at the beginning of **measure 9**.

When the program is **played**, the first eight bars will play just as entered from the synthesizer, and the second eight measures will be transposed **up five semi-tones**.

## TO TRANPOSE DOWN:

Since the **default function** is to transpose **up**, the command is slightly different to transpose **down**. Try entering the eight bar example again, only use the **COPY with TRANSPOSE** to drop the pitch down 7 semi-tones.

The command reads: **Copy from beginning to end one time minus 7 semi-tones.**

On the MC-4 press:

CP EN EN EN — 7 ME

The **minus command** is selected by pressing the '—' key to the right of the calculator keyboard.

Display shows:

C...-7

This changes to

1 17 1 -

when the **ME** key terminates the command sequence. With the 8 bar figure successfully copied and transposed, the display on the MC-4 should show that it is at **STEP 1 of MEASURE 17**, and is **waiting** for an entry.

**Play the transposed melody.** When **playing** the piece, it will play as entered for the first eight measures, then will **transpose down seven semi-tones** for **measures 9-16**.

The **transpose** function will **save hours** of work when entering long compositions.

## 4G-3: COPY A MEASURE

So far, the **COPY** function has been used to copy the melody entered from **beginning** to **end**.

**Beginning** and **end** are **default** functions of the **COPY** command, and were entered by pressing the **EN** key **2 times**. In the **COPY** mode, these default functions are shown on the display as **commas** **'**. The **first** comma tells the MC-4 to copy from the **beginning**, the **second** comma tells it to copy to the **end**.

To copy a **measure**, specify the measure to be copied by entering the **measure #** before pressing the **EN** key. Also, tell the MC-4 to copy the measure from **beginning** to **end**.

To copy a measure, the command reads: **copy measure 3 from beginning to end one time,**

On the MC-4 press:

**CP 3 EN 3 EN EN**

Before pressing **ME**, the display shows:

**03,3, ,**

By entering the number **3**, you are specifying which measure is to be copied. The **first** entry tells the MC-4 to copy **from the beginning of measure 3**, and the **second** entry tells it to copy **to the end of measure 3**. The **3rd comma** on the display means copy **one time**.

### NOTE:

**a:** A measure may be copied at any point in the piece.

**b:** To **insert measure 3** at the beginning of **measure 9**, open the beginning of **measure 9**, press **INS** key then enter the command as shown above. This assumes that data has been entered in **measures 1 to 8**. If there is no data in measure 9 (just after entering data in measures 1 to 8), the **INS** key is not required.

**c:** If data exists in measure 9, and copied without proceeding the **INS** key, the data in measure 9 will be replaced with the copied data.

See **APPENDIX A-6**, for a useful short form command when copying only one measure.

#### 4G-4: To COPY a GROUP of MEASURES

Follow the above procedure, with this exception. Enter the **first measure** to be copied, followed by the **last measure** to be copied.

Don't worry about making a mistake, because the **MC-4 will not allow copying outside of the current boundaries and will alert you with a 'BEEP'. This will not wreck the program!**

#### 4G-5: COPY from CHANNEL to CHANNEL

To copy from **channel to channel**, there **must be data** in **at least one channel**.

**1: Go to CHAN 1 MEAS 1 STEP 1.**

Enter the 8 bar figure, in CHANNEL 1, with the synthesizer keyboard, as in the previous section. If the MC-4 is still in CV 1 + GATE mode, goes to CV 1 mode (**SHIFT 1**).

**2: Go to CHAN 2 MEAS 1 STEP 1 (SHFW).**

**3: Press 1 CP EN ME.**

This command tells the MC-4 to copy **channel 1 from beginning to end one time**. Channel 2 should now contain the **same data** that was played into channel 1.

Enter this again, using the **COPY** with **transpose** function.

To **copy channel 1 and transpose**, press **1 CP EN EN EN 5 ME**. This will copy channel 1 and **transpose up 5 semi-tones**.

For all of the **COPY commands**, see **APPENDIX A-6**.

## 4H: ADDITIONAL FUNCTIONS in the LIVE KEYBOARD MODE

There are two more functions to examine at this time.

The first is **changing the default time signature**, and the second is **entering a specified number of measures**.

When programming the MC-4 in the **CV 1 + GATE mode**, the **default time signature** is **4/4**. The **metronome** will count **four beats per bar** and then **advance** to the **next measure**. The metronome does **not stop counting** until the **MEASURE END** key is pressed at the **end** of the **piece**.

The MC-4 will count to the **end** of the **current measure**, then **stop**.

When programming in the live keyboard mode, you **may tell** the MC-4 to enter **8 measures only**. The metronome will count to the end of measure 8, then **stop**. This procedure was used in the **multi-voice programming example** earlier in this chapter.

To **enter a specified number** of measures in the live keyboard mode, the procedure is very simple;

- 1: **Go to CHAN 1 MEAS 1 STEP 1 (CV 1 + GATE mode).**
- 2: **Press 4 EN (time sign.), 8 ME (8 = number of measures).**

The **metronome** will **start the eight beat count-in** when the **ME** key is pressed, and will **stop counting** at the **end of measure 8**.

To change the time signature to **3/4 time**, and enter an **8 bar piece**, the procedure is:

- 1: **Go to CHAN 1 MEAS 1 STEP 1 (CV 1 + GATE mode).**
- 2: **Press 3 EN 8 ME.**

The **metronome** will start the **6 beat count-in** upon pressing the **ME** key, but the measure number will **advance after three counts**, because the time signature is 3/4. The MC-4 will still **stop** at the **end of measure 8**.

Both of these commands may be used in the **GATE REWRITE mode** as well. The only difference is that the MC-4 must be in the **GATE REWRITE mode (SHIFT 8)**, instead of **CV 1 + GATE mode (SHIFT 7)**.

**Remember to change time signatures when using GATE REWRITE in time signature other than 4/4.**

## 4I: CHANGING the DEFAULT TEMPO VALUE

The **default tempo value** of the MC-4, is **100** beats per minute, when the **tempo knob is in the center position**. This is displayed when using the **CURSOR KEYS** '>' or '<'.  
TEMPO 100

**DISPLAY SHOWS:**

TEMPO 100

To change the **default tempo value**, **cursor** to the **TEMPO display**. Press **120 ENTER**, and the tempo value will be 120 beats per minute. **Cursor left** and the display will show:  
TEMPO 120

TEMPO 120

## 4J: SUMMARY OF CHAPTER FOUR

By now you should be comfortable with the operating procedures of the MC-4 in the live keyboard mode. The basic editing functions covered in this chapter should give some insight as to the potential of the MC-4.

Again, it is important to keep your musical examples simple when first experimenting with the different functions. Go through the instructions in each section a number of times, and examine the effect closely before moving on to the next section.

If you wish to get more involved with programming procedures, study **CHAPTER 1**, and learn how to program the MC-4 with the **calculator keyboard entry** mode. This will give you a more comprehensive understanding of the commands and functions available on the MC-4, and it may also make the **live keyboard entry** mode easier to understand.

For more details on the **expanded editing functions**, refer to **APPENDIX A**.

**\*\*Remember to SAVE the programs on cassette tape!**



## CHAPTER FIVE

# MULTI-TRACK RECORDING USING THE MC-4

### 5A: PREFACE

The original proto-type of the **microcomposer** was developed solely for use in the studio, using a **multi-track tape recorder**.

The reason for this was dictated by the available technology, which was several years before the introduction of the **single chip microprocessor**. At that time, circa 1972, it was far too difficult and expensive to fabricate a multi-voice sequencer, so a scheme had to be developed to allow the recording of more than one voice with complete synchronization.

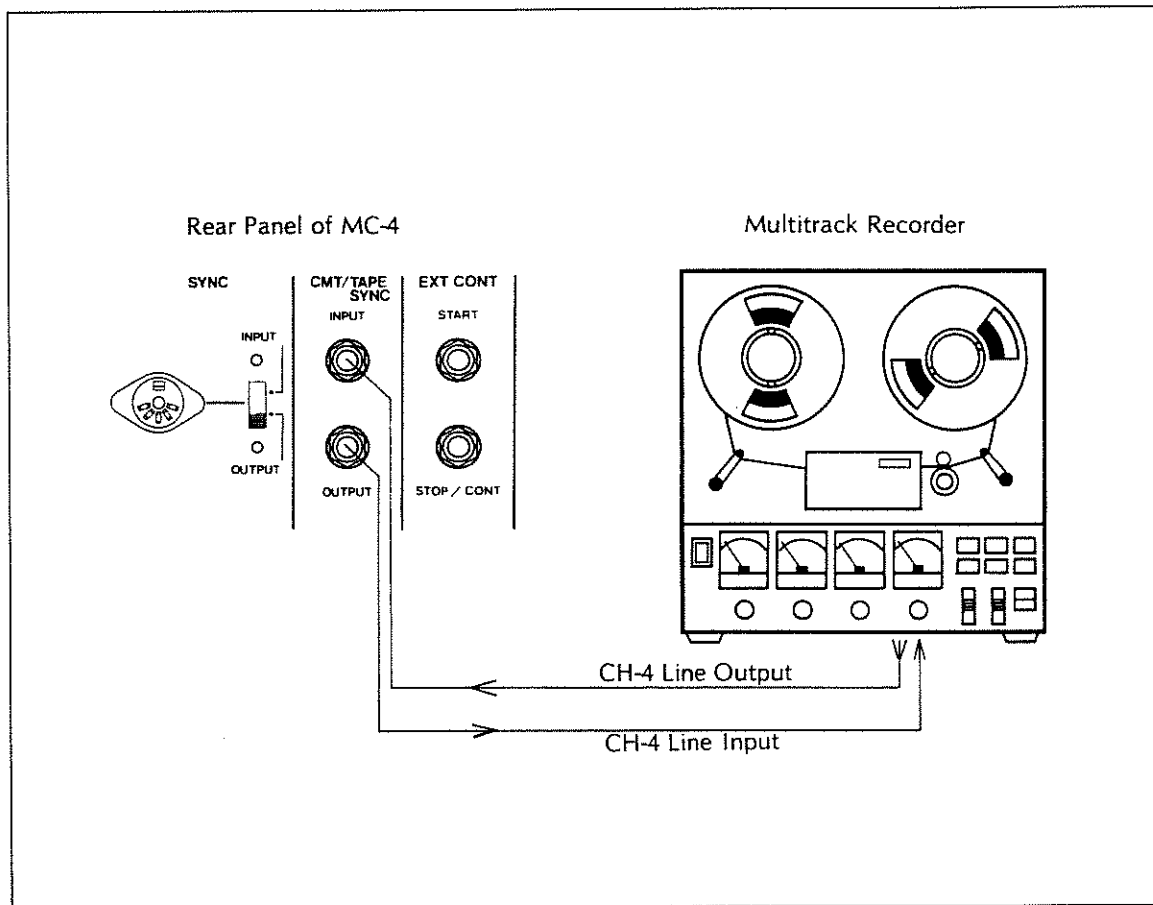
If a tone were to be recorded on one channel of the tape recorder, with the tone being switched between two frequencies by the **clock** output of the sequencer, then the **tempo** of the musical composition would be **encoded** on tape. All that would remain, would be to play the tone from the tape back into the sequencer and **restore the clock** from the frequency shifted tone. This way, the sequencer would know **exactly** when to play each of the separately programmed lines of music. This process greatly expands the capabilities of the sequencer, by allowing **many channels** of music to **synchronize** with each other.

Even though the MC-4 is capable of producing four independant channels at once, this isn't nearly enough for most complete pieces of music, as many pieces will contain up to **20-30** separate parts. The MC-4 was designed with **multi-track** recording in mind, and is capable of turning a relatively inexpensive 4 or 8 track recorder into a 12 or 28 track recorder without having to **'bounce'** or **'sub-mix'** any tracks.

This capability is the **real strength** of the MC-4, and turns it into an extremely **powerful** tool in the hands of the serious musician. This chapter will show the user the step by step procedures for multi-track recording, starting with simple two track synchronization and ending up with examples on using the MC-4 in a large recording studio, with sync'ing up to **23 tracks**.

## 5B: SYNC TONE OUTPUT/INPUT HOOKUP

DIAGRAM 5B-1:



The hookup for **tape sync** is detailed in **DIAGRAM 5B-1**, and should be patched according to the number of tracks available on your multi-track tape recorder.

If you have a 4 track, then use **track 4**, or, if you have an 8 track or larger then use the **last track**. Most modern recorders have very good **edge track response**; this keeps the **sync tone** out of the way of the music tracks. **Leakage** should not be a problem, as it is possible to achieve very reliable sync at levels of **-10 to -20db**.

If your recorder has **dbx [tm]** noise reduction, then **disable** the dbx for the **sync channel only!**

By now you should be familiar with the basic keystroke commands. If you are not, then **review CHAPTERS 1 and 2**. (for those of you who used **CHAPTER 3** only, please review **CHAPTER 3** and read through **CHAPTERS 1 & 2**).

## 5C: PREPARING A PROGRAM FOR TAPE SYNC

We will assume that the recorder is a **four** track or larger. Using program sheet #1 for the 4 voice example, enter the pitch (**CV 1**), dynamics (**CV 2**), **STEP TIMES** and phrasing (**GATE TIME**) for **channel 4**, which is the **bass part**. The reason for selecting the **BASS** part first is an arbitrary one, but it does make good musical sense, as the **bass** generally dictates the **structure** of the composition.

This part may be entered into **channel 1** of the MC-4, as may all of the parts, because we will be using only **one channel at a time for this session**.

Before continuing, use the **insert** key '**IN**' to insert 2 measures at the beginning of the piece. This is for **count-in** purposes.

### For example:

- 1: **In CV 1 mode, set the MEASURE & STEP display to MEAS 1, STEP 1.**
- 2: **Type SHEN** to mark the inserting position.
- 3: **IN n EN IN ME IN n EN IN ME.** (The 'n' can be any value for CV 1.)  
This inserts 2 blank measures.
- 4: **Select CV 2.**
- 5: **Type 0 EN EN.** This turns off the **dynamics VCA**.
- 6: **Select ST.**
- 7: **Type 192 EN EN.** This makes each measure a **whole note**.
- 8: **Select GT.**
- 9: **Type 0 EN EN.** This turns off the **ADSR** creating 2 measures of **whole note rests**.
- 10: **Type SHEN** to erase the marker.

This completes the **2 measure count-in** programming. This will be used at the beginning of each of the voices as we are ready for them.

## 5D: BASIC TAPE SYNC PROCEDURES

This set of instructions will form the base of tape sync recording, so read carefully and think about each step before it is performed! The step by step procedures for **tape sync recording** are as follows:

**1: Cursor back (<) to the TEMPO display.** Set to the desired tempo in beats per minute. E.G; **TEMPO 120 EN.** Set the Tempo knob to **center**.

**2: Play the first part and fine tune the TEMPO. This is very important** as the TEMPO recorded on tape via the sync tone is **not adjustable** once recorded. Imagine, if you will, spending several hours programming and recording several tracks of parts and finding out that the **tempo is wrong!** A little care taken now will save many hours of work later.

**3: Although it is possible to record the sync tone and MC-4 program on the same first pass on the tape, it is advisable to record the sync tone only the first time.**

**4: With the patch properly set up as in the diagram, adjust the INPUT LEVEL on the recorder to -10db on the VU meter for the sync channel.**

**5: When everything is OK to here, put the MC-4 in the PLAY mode.**

**6: Start the recorder in record** and wait for 10 seconds while the recorder records some steady sync leader tone. This will insure that proper sync will occur for all of the parts and will give you time to press the **START** key when recording the music parts later.

**7: After 10 seconds hit the START key.** Listen to the sync tone and it should change from a steady high pitch to a well modulated tone. This is the **clock** from the MC-4 rapidly shifting the sync oscillator between 2 frequencies. At the end of the piece, the MC-4 will stop and the sync tone will become a steady tone again. **Rewind the tape to the beginning of the sync tone.**

**8: Switch the recorder to 'SYNC' or 'MONITOR',** whichever way that enables the recorder to **playback** from the record heads (or sync heads). It is possible to play the sync tone from the normal **PLAYBACK HEADS** of the recorder, but this is not good practice and will be inconsistent with later procedures.

**9: Do a trial playback of the recorded sync tone** and adjust the output level of the recorder to -10db. This should be sufficient level to trigger the MC-4.

**10: At this point, be sure that the synthesizer is in tune and the sound is the way you want it.** Run the MC-4 (without recording), and adjust the output level on the synth so that the maximum level reached in the piece of music is within the tolerances of the recorder and mixing system being used. (Read **The foundations of electronic music, by ROBIN GRAHAM, published by ROLAND,** to learn the proper recording techniques to use with synthesizers.)

- 11:** Set the **SYNC mode switch** on the front panel of the MC-4 to **TAPE sync**.
- 12:** **Rewind to the start of the sync tone leader.** Put the recorder in **record** on the track being used for this part, and **start** the tape.
- 13:** **Be sure that the sync leader tone is visible on the VU** for its channel.
- 14:** **Press START on the MC-4.** As soon as the modulated sync tone appears, the MC-4 display should start counting the measures & steps. The first 2 measures will be silent (as programmed earlier), and starting at MES 3, STP 1, the synth should start playing. **If this doesn't happen as it should, then REWIND the tape, and adjust the sync track output level 3 to 6 db higher than before. Repeat steps 12-14.** If this doesn't work, then **clean the heads on the recorder!**
- 15:** At the end of the part, the MC-4 will stop. **Rewind the tape and have a listen.** If everything is recorded properly, then we will **verify sync**.
- 16:** **Patch the synth** to the next track on tape and adjust the levels. **Rewind the tape!**
- 17:** Put the track just recorded into the 'SYNC' mode on the recorder. It isn't necessary to record this next track, as it is being used to check the sync.
- 18:** **Start the tape, then hit START on the MC-4.**
- 19:** While monitoring the first track, listen to the live playback of the MC-4 and see that they are playing **perfectly together**. In fact, it should be so perfect that the parts will **phase**. If this is not the case, then an error occurred by not starting while the **leader tone** was present, or a faulty **sync tone** read by the MC-4, or the recorder not being in 'SYNC'.
- 20:** **If everything works perfectly up to here, then continue, else re-do all of the steps starting at step 4.**
- Everything after **step 20** is done exactly as before, except with a new program in **chan 1** of the MC-4, a **new track** on tape being setup, and a different **sound** setut on the synth.
- 21:** Key in the part for **chan 2** on the program sheet into **chan 1** of the MC-4.
- 22:** **Insert 2 blank measures as in SECTION 5C.**
- 23:** **Patch the synth to the next available track on tape.**
- 24:** **Repeat steps 4-15.** (varification of sync will probably not be necessary here unless some problems occurred.

**25:** Repeat with the remaining parts on the program sheet.

**26:** If a 4 track recorder is all that is available, then the last part could be '**mixed live**' in **sync**, or 2 channels could be recorded at one time, by mixing them to 1 track on tape.

If all went well following all of the details in this step by step procedure, then you are well on the way to recording **masterpieces** using the MC-4. If you had trouble, then take care and examine your methods, comparing them in detail to those listed in this section.

# APPENDIX A

## MC-4 MICROCOMPOSER COMMAND SUMMARY

### A-1: INTRODUCTION

Before you attempt to use this appendix, spend a few minutes examining the **display format** of the MC-4.

The **display** of the MC-4 is fully alphanumeric, with 15 columns of character positions available. Each of the **command modes** uses a different format to best present the command types and respective data. Many of the modes prompt the user with a complete spelling of the command type, or if space does not allow, an **abbreviation, or mnemonic** is used instead.

As mentioned, there are **15 columns** or positions, starting at the extreme left. As various commands or data are entered, the **CURSOR**, a '└' shape indicator, will advance to the right to indicate the **next available position**, which means that the MC-4 is **waiting** for an **entry**.

We will illustrate the display format in a consistent manner, to avoid confusion. In each of the **command descriptions**, the display will be exactly as shown on the MC-4, with the characters each taking up one position.

#### The **CURSOR KEYS** ( < cursor left) ( > cursor right)

These are used to **move** the **CURSOR BACK & FORWARD** through the **initial command levels**, as well as in the selection of the **CHANNEL, MEASURE, STEP** and **DATA** columns on the display.

Several of the other keys have similar functions, which will be listed as alternates when describing the **key functions**.

## A-2: BASIC OPERATING COMMANDS

### 1: INITIAL COMMAND LEVELS

These are displayed at **power on**, and prompt the user by offering a **choice** of the **pre-programmed default values**, or **user values**. There are **3 command levels** which may be selected at any time with the **CURSOR** keys:

- 1: **TIMEBASE**    **TB**
- 2: **TEMPO**      **TEMPO**
- 3: **CHANNEL**    **select CH, MES, & STP**

```
TB 120 30 15
TEMPO 100L
_
1  _
1  1  _
```

### 2: COMMAND MODE

This is selected using the **MODE** switch. There are **3 command modes**:

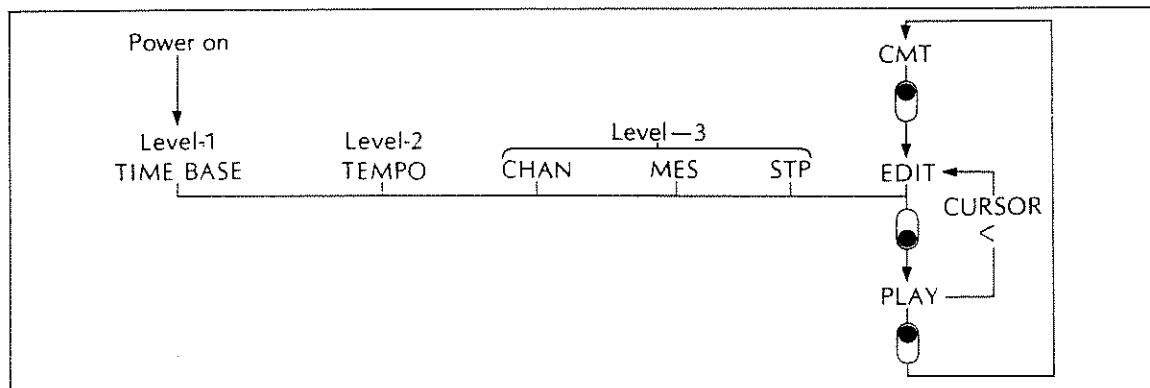
- 1: **EDIT**            **data entry and editing**
- 2: **PLAY**           **playing the program**
- 3: **CMT**            **cassette storage**

### 3: COMMAND TYPE

Some of the **command types** are functions such as **COPY 'CP'**, **SHIFT COPY 'SHCP'**, **ENTER 'EN'** and **MEAS END 'ME'**. These are used to **select the way** in which data is entered or modified when in any of the **command modes**. Their functions will be described as they are introduced in the **next section**.

### 4: DATA

The following detailed **command summary** will list a series of keystrokes, for which a **'value'**, or **'#'** is required. These are the actual number entries from the **calculator keypad** or **external synthesizer keyboard**.





## A-3: LEVEL ONE

### 1: TIMEBASE

TB	120	30	15
----	-----	----	----

This is the **display** when the MC-4 is **powered on**. The **TIMEBASE** level display shows the fact that the MC-4 is filled with **default values** which may be changed, or left alone. The first number is **120**, which refers to **120 divisions per beat**. This value has been selected to provide the **best** results in **live keyboard** entry. For **calculator keyboard entry**, this value may be changed to a number like **48**, which is **divisible** by many numbers for the **most commonly used step time values**.

If the piece of music being programmed contains **odd group values**, such as **triplets**, **quintuplets** etc, and **even group values**, the **TIMEBASE** must be **divisible** by each of the group's size. For instance, a **triplet** has a group size of **3**, a **quintuplet** group size is **5**, and **1/4 note**, which is eight 1/32nd notes, has a group size of **8**.

By **multiplying** the group sizes required of the music, the **TIMEBASE value** that correctly defines these time values may be easily calculated.

The following table of **STEP TIME values** for **different TIMEBASES** will help in these calculations.

#### NOTE:

















**a:** Musical **time values** are based on **powers of two**. All that is required for the calculations is an elementary knowledge of **fractions**.

**b:** There is a limit to the size of the **TIMEBASE** or **TEMPO** values. This limit is:

$$\text{TIMEBASE} \times \text{TEMPO} \leq 20,000$$

In other words, the **TIMEBASE** times the **TEMPO** should not exceed 20,000. If, for example, a value of 120 is selected for **TIMEBASE**, then the **TEMPO** cannot exceed  $20,000/120 = 166$ . Because the MC-4 is 'smart', it will automatically scale down the **TEMPO** value if the **limit is exceeded**. Try it for yourself, with different values, and see how the MC-4 will prevent oversize entries.

## 2: TABLE OF COMMON TIME VALUES

<u>1/4 note = 1 beat</u>					
<u>Time value</u>	<u>As Written</u>	<u>TB = 32</u>	<u>TB = 48</u>	<u>TB = 60</u>	<u>TB = 120</u>
Whole note		128	192	240	480
Dotted Half		96	144	180	360
Half Note		64	96	120	240
Dotted 1/4		48	72	90	180
1/4 Note (TB)		32	48	60	120
Dotted 1/8		24	36	45	90
1/4 Triplet		ND	32	40	80
1/8 Note		16	24	30	60
1/8 Triplet		ND	16	20	40
1/16 Note		8	12	15	30
1/16 Quint		ND	ND	12	24
1/16 Triplet		ND	8	10	20
1/32 Note		4	6	ND	15
1/32 Quint		ND	ND	6	12
1/32 Triplet		ND	4	5	10
1/64 Note		2	3	ND	ND

**NOTE:**

The **emphasized** values are the **TIMEBASE**. For **time signature denominators** other than '4' multiply or divide these values by '2', as necessary.

'ND' means **NOT-DIVISIBLE!** (The **TIMEBASE** is not divisible by the designated group size!)

Try substituting other note values to determine the **proper TIMEBASE value**. As you will see, almost **any conceivable note-time relationship** may be programmed in the MC-4.

### 3: DEFAULT STEP AND GATE TIMES

The next value displayed **30** is the **default step time** (1/16ths) which fill the **STEP TIME** memories for ease of use in checking pitch values. This allows **pitches only** (CV 1) to be entered, which will be played as **1/16** notes to rapidly check pitch values. The **GATE TIME** default value is **15**, which **phrases** the 1/16th notes as **semi-detached**.

### 4: LEVEL ONE KEYSTROKES

---FUNDAMENTALS---

- a) TB value **EN** ST value **EN** GT value **ME** to **next level**.
- b) > to **next level**.
- c) **ME** to **next level**.

\*\*\*\*\* EXTENDED \*\*\*\*\*

- d) TB value **ME** sets **TB** only.
- e) TB value **EN** ST value **ME** sets **TB & ST**.
- f) **EN** ST value **ME** sets **ST** only.
- g) **EN** **EN** GT value **ME** sets **GT** only.

All of these advance to **LEVEL 2** when **ME** is pressed. **ME** is the **command terminator** for commands that offer **multiple entries**.

- h) **DL ME** **DELETES ALL DATA.**

Note that this command will erase **all data** in the **MC-4** including **TIME BASE**, and will remain in this level. It is useful for copying files in the digital cassette mode. See **APPENDIX D-3**.

## A-4: LEVEL TWO

### TEMPO

TEMPO 100 L

The **default TEMPO value** is displayed as **100 beats per minute**. This value may be changed before advancing to **level three**, or at any time by using the **CURSOR <** or **>** keys. When in **level 3**, use **<**; when in **level one**, use **>**.

The **tempo** may be adjusted with the **TEMPO control knob** within the range of **1/2 to 2x** displayed tempo value. The tempo of displayed value is obtained by setting the control at the center position.

The **tempo** may be **precisely** varied, under **program control**, by connecting **CV 2** of any channel to the **TEMPO CV INPUT**. A CV value of **50** sets the tempo at the **programmed value**. The tempo may be retarded, or accelerated, smoothly or abruptly, by changing these **CV 2** values. This is shown in **APPENDIX C**.

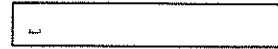
When any **CV 2** is patched to the **TEMPO CV INPUT**, the **TOTAL TIME function** will calculate the playing time precisely, allowing for all changes in **TEMPO** programmed in the **TEMPO CV 2**.

### 2: LEVEL TWO KEYSTROKES

- a) TP value **EN** or **ME** sets **TP**.
  - b) **>** or **EN** or **ME** or **ME** keeps **default**.
- Any of the above advances to **level 3**.
- c) **<** to **level 1**.

## A-5: LEVEL THREE KEYSTROKES

### 1: CHANNEL



#### — — — FUNDAMENTALS — — —

- a) > or EN or ME default CH 1.

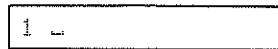
Any of the above will advance **cursor** to **measure** position.

- b) < back to **level 2**.

#### \*\*\*\*\* EXTENDED \*\*\*\*\*

- c) CH 1-4 BK goes to **beginning**.
- d) CH 1-4 FW goes to **end**.
- e) CH 1-4 DL EN or ME **deletes** channel, goes **MES** position.
- f) CH- 1-4 DL BK or FW **deletes** channel, goes **beginning**.

### 2: MEASURE



#### — — — FUNDAMENTALS — — —

- a) > or MES # EN or ME default measure 1.

Advances to **step** position.

- b) < back to **CH** position.

#### \*\*\*\*\* EXTENDED \*\*\*\*\*

- c) BK goes to **beginning**.
- d) FW goes to **end**.
- e) DL measure # ME **deletes** a measure.
- f) DL from MES # EN to MES # ME **deletes from mes # to mes #**.

3: STEP

1	1	1
---	---	---

--- FUNDAMENTALS ---

a) > or STP # EN or ME

default step 1.

Any of the above advances to the **EDIT** mode.

b) <

back to **MES** position.

\*\*\*\*\* EXTENDED \*\*\*\*\*

c) **BK**

goes to **beginning** of measure.

d) **FW** (beep)

goes to end of meas just **before ME**.

**E.G;** 1 1 17 ME)

## A-6: COMMAND MODES

After selecting the **default values in levels 1, 2 & 3**, the MC-4 is in the **EDIT** mode. It is in this mode that all of the data, using the **calculator keyboard** or an **external synthesizer keyboard**, is **entered**. The MC-4 is equipped with a very powerful set of **edit command types**, such as **COPY, REPEAT, DELETE, INSERT** etc.

Many of the functions in this mode use the **SHIFT** key. This allows the MC-4 to have a deceptively sparse keyboard layout. The **SHIFT** key is used by **holding down** the **SHIFT** key, and while holding it down with one finger, pressing the **selected shift function** with another finger or a finger on the other hand.

We will start with the **basics**, then illustrate the **extended command types**.

### EDIT



#### — — — FUNDAMENTALS — — —

The ‘—’ at the right edge of the display is a **prompt**, and tells us that the MC-4 is **waiting for data** from the calculator or external synthesizer keyboard.

The **SHIFT MAP display** shows in which memory the data will be stored. The **EDIT mode LED** will be **ON**.

- |    |                                   |   |
|----|-----------------------------------|---|
| a) | DATA value <b>EN</b>              | data entry, <b>STP</b> will advance.                            |
| b) | DATA value <b>ME</b>              | data entry, <b>MES</b> will advance in (CV1 only).              |
| c) | <b>external kbd</b> (played note) | data entry, <b>STP ONLY</b> will advance (in CV1 and CV2 only). |
| d) | <b>SHIFT — ME</b>                 | inserts a <b>ME</b> .   |
| e) | <b>BK</b>                         | back one step.  |
| f) | <b>FW</b>                         | forward one step.   |

**Note:** In CV 1 mode, this treats **tied** notes as one and **beeps**.

- |    |                      |                              |
|----|----------------------|------------------------------|
| g) | <                    | back to <b>STP</b> position. |
| h) | <b>SH — 1 thru 9</b> | select <b>data type</b> .    |

This selects 1: CV 1, 2: ST, 3: GT, 4: CV 2, 5: MPX, 7: CV 1 + GT, 8: GT REWRITE, 9: TUNE.

The **SHIFT 6** command, in **GATE TIME** mode only, selects **step time** (with ',') or **step number** (without ',') in the display **alternatively**.

- i) **IN data EN** **inserts data in CV 1 only.**
- j) **DL EN** **deletes data in CV 1 only.**
- k) **RP EN or ME** **begin section to be repeated.**
- l) **RP RP # of times EN or ME** **end section to be repeated, # of times.**

\*\*\*\*\* EXTENDED \*\*\*\*\*

This set of **command types** reveals the **excellent editing commands** in the MC-4. These are very **logically** thought out, and will present no difficulty if followed in the step by step method detailed in this section.

- a) **# of times IN data EN** **inserts data # of times.**
- b) **# of steps DL EN** **deletes # of steps of data.**
- c) **CP start mes EN end mes EN # of times ME** **copies data from mes to mes, # of times.**
- d) **CP start mes EN end mes EN # of times EN  
+ or - bias ME** **copies data from mes to mes, # of times, with transpose.**

With this command, **bias** is the number of semi-tones the measure is to be **transposed, up or down**.

- e) **CP mes # + or - bias ME** **copies the measure being displayed with TR.**
- f) **CP mes # ME** **copies the measure being displayed with no TR.**
- g) **chan 1-4 CP start mes EN end mes EN # of times  
+ or - bias ME** **copies from another chan, from mes to mes, # of times, with TR.**
- h) **IN chan 1-4 CP start mes EN end mes EN # of  
times EN + or - bias ME** **inserts with copied data, from mes, to mes, # of times, with TR.**



- i) **SHCP** start mes **EN** end mes **EN** + or – bias **ME**      **TR** from mes, to mes, with bias.
- j) **SHCP** mes # + or – bias **ME**      **TR** only the mes, with bias.
- k) **SHCP SHCP** start mes **EN** end mes **EN** + or – bias **ME**      In **GT**, **copies** data from **ST**, **from** mes, **to** mes, with bias.  
  
In **CV2**, **copies** data from **CV 1**, **from** mes, **to** mes, with bias.
- l) **IN** DL value **EN**      **divides** data by value.
- m) **DL** DL value **EN**      **combines** data.
- n) **SHEN**      sets or resets mes and stp **marker**.

When data mode is changed, display goes back to **marked** position (measure and step number).

- n') **SHEN IN** value **EN SH-n**      inserts value and returns to **marked position**.

This function is **very** useful when **inserting** values in a channel. The step counter is incremented and displayed as such, but the MC-4 **returns** to the **marked position** after pressing **any SHIFT** command of:

**SH 0-9, SHBK, SHFW.**

This allows selecting the next **data type** (i.e; **ST, GT, CV 2**), **returning** to the **marked position**, and **inserting or modifying** values without having to step back (**BK**) manually to the **insert point**.

To cancel the mark, simply press **SHEN** again.

## A-7: PLAY MODE

To enter the **PLAY** mode, press the **MODE** switch down once. The display shows:

1 1 1 PLAY

and the **LED** under the **ME** key is **ON**.

Remember that the **EN** and **ME** keys become **START** and **STOP/CONT** keys in this mode.

### — — FUNDAMENTALS — — —

- |                      |   |
|----------------------|---|
| a) <b>EN</b>         | <b>starts</b> program.                          |
| b) <b>ME</b>         | <b>stops</b> program.                           |
| c) <b>BK</b> any key | displays <b>total time</b> then <b>escape</b> . |
| d) <b>FW</b>         | displays <b>step errors</b> .                   |
| e) <b>FW FW</b>      | displays <b>next step errors</b> .              |
| f) <b>FW ME</b>      | displays <b>step error</b> then <b>escape</b> . |
| g) <b>&lt;</b>       | back to <b>EDIT</b> mode.                       |

### \*\*\*\*\* EXTENDED \*\*\*\*\*

- |                                  |  |
|----------------------------------|--|
| a) start <b>EN</b> end <b>ME</b> | <b>plays</b> from start to end.                      |
| b) mes # <b>ME</b>               | <b>plays</b> only the mes.                           |
| c) start <b>EN</b> end <b>BK</b> | <b>playing time</b> from start to end measures.      |
| d) mes # <b>BK</b>               | <b>playing time</b> of the mes.                      |
| e) start <b>EN</b> end <b>FW</b> | checks <b>step errors</b> from start to end measure. |
| f) mes # <b>FW</b>               | checks <b>step error</b> of the mes.                 |

**NOTE:**

While in the **PLAY** mode, the **STEP** display is indicating the **step number** in the **current measure**.

If you move to a **different command type**, while in the **PLAY** mode, (I.E; CV 1, CV 2, ST, GT, MPX etc.) the display will show the **data value** of the **command**.

If CV-2 of any channels is patched to the **TEMPO CV INPUT**, the playing time, as affected by the tempo-controlling CV-2 data, is displayed, as well as the channel number of the **CV 2**. If the **TEMPO CV INPUT** is connected with the **CV 2** of a channel where there is no data, 0 will be displayed for the **TOTAL TIME**.

**Channel 1** (or least existing channel) is the reference for **step errors**.

For more, see **SECTION 3K: in CHAPTER THREE**.

## A-8: CASSETTE MEMORY TRANSFER

### — — — FUNDAMENTALS — — —

To enter the **CMT** mode, push the **MODE** switch down, until the display shows:  
**A-CMT MODE.**

- a) **7 name ME** **saves** program with file name.
- b) **8 ME** **verifies** program.
- c) **9 ME** **loads** program.

This set of commands will **SAVE, VERIFY** and **LOAD all existing channels** of memory.

To **SAVE, VERIFY** and **LOAD selected channels**, see **next extended commands**.

### \*\*\*\*\* EXTENDED \*\*\*\*\*

- a) **7 file name EN chan # 1-4 ME** **saves** specified chan.
- b) **8 file name EN chan # 1-4 ME** **verifies** specified chan.
- c) **9 file name EN chan # 1-4 ME** **loads** specified chan.

## A-9: REAL TIME LOADING IN EDIT MODE

For real time loading in EDIT mode, the MC-4 must be in CV 1 + GATE position.

### — — — FUNDAMENTALS — — —

- a) **SH7** # of measures **ME** (play from kybd) **ME** loads CV 1, STP, GATE in **real time**.
- b) **SH8** # of measures **ME** (play form kybd) **ME** STP, GATE **rewrite**.

### \*\*\*\*\*EXTENDED\*\*\*\*\*

- a) **SH7 n EN m ME** (play from kybd) loads CV 1, STP, GATE in **real time**.

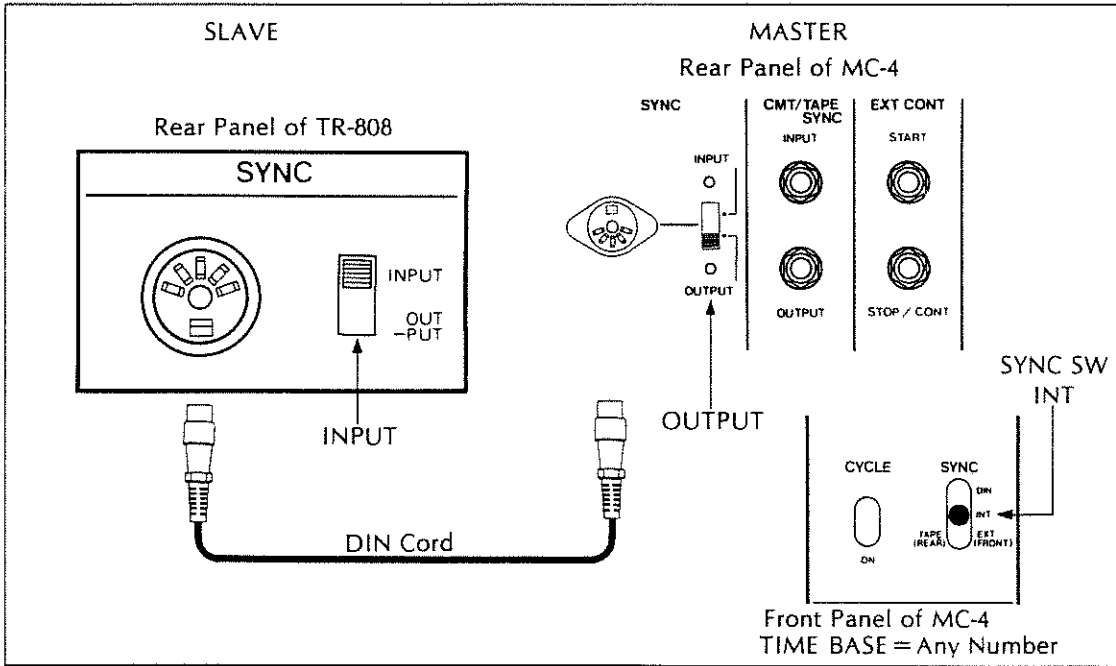
**NOTE:** **n** = # of beats per measure (time signature)  
**m** = # of measures (MC-4 stops at end of last mes)  
Default time signature (n) = 4/4 time

- b) **SH8 n EN m ME** (play timing only from kybd) STP, GATE **rewrite**.
- c) **FW** **mes** increment.
- d) **BK** **mes** decrement.

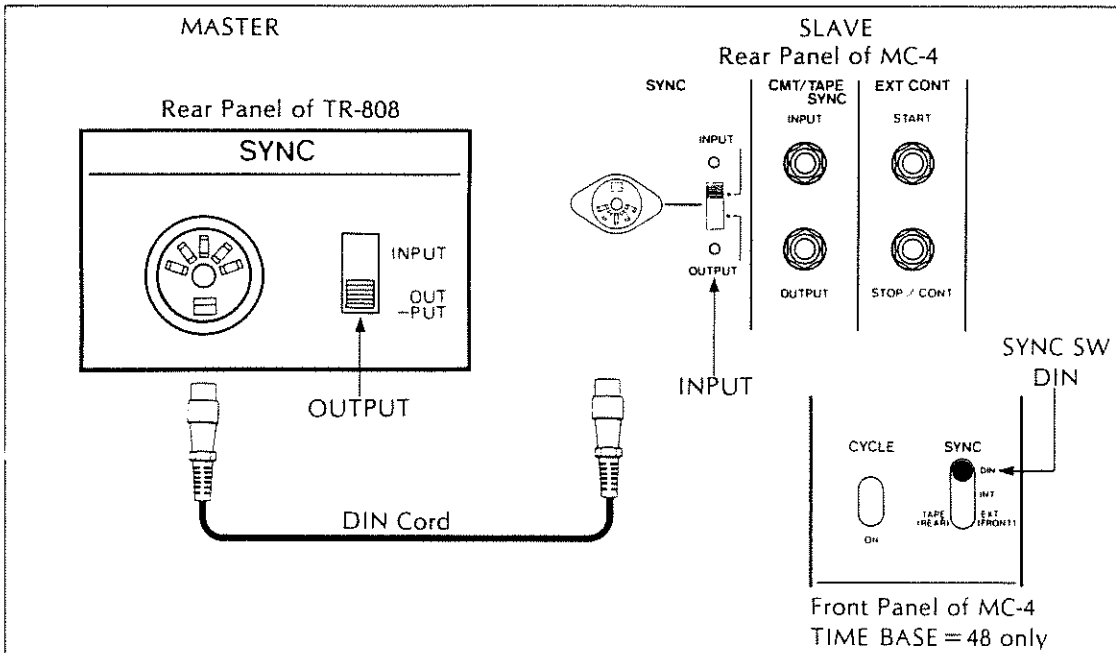
# APPENDIX B

## HOOKUP DIAGRAMS

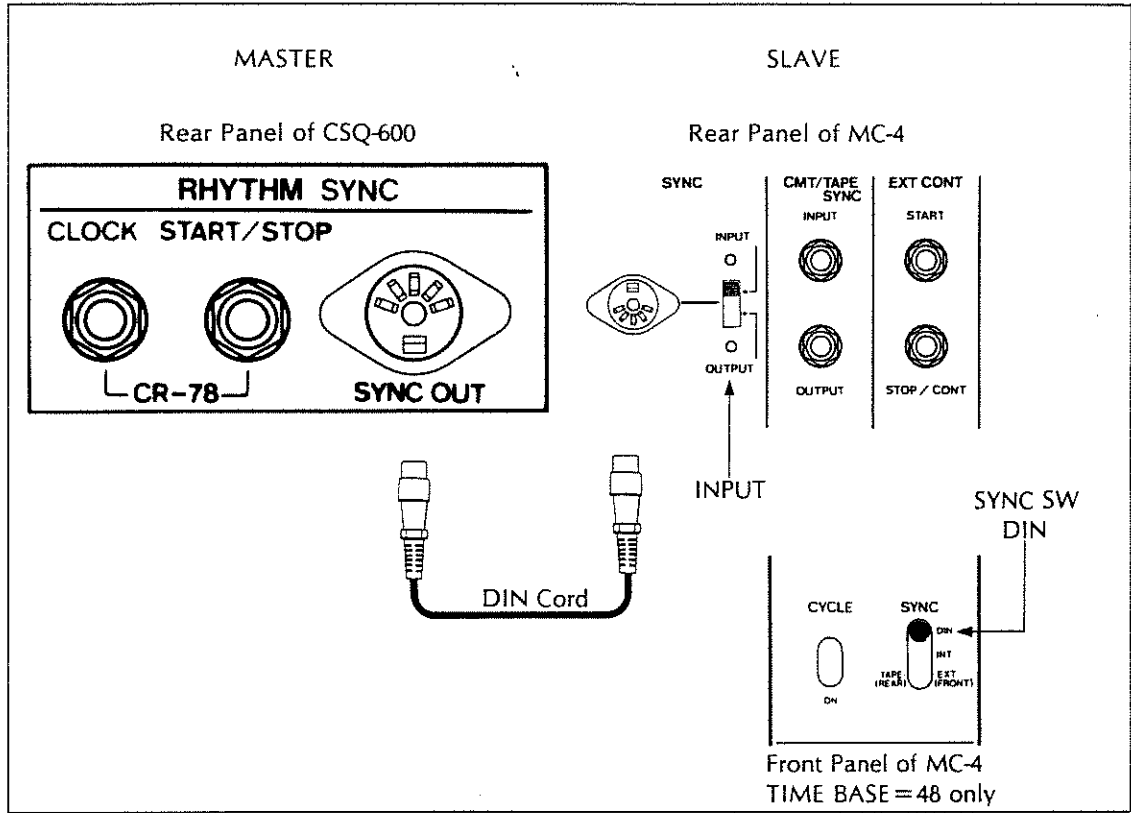
**DIAGRAM B-1:** SYNC from MC-4 to TR-808



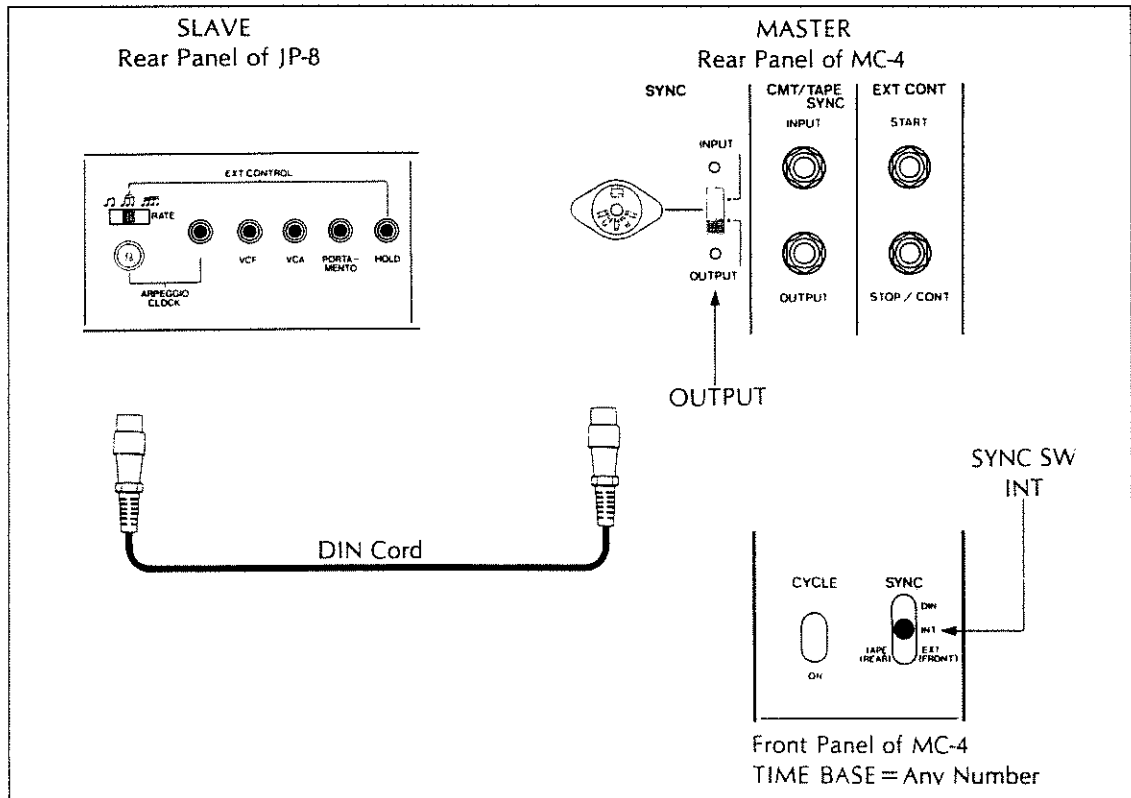
**DIAGRAM B-2:** SYNC from TR-808 to MC-4



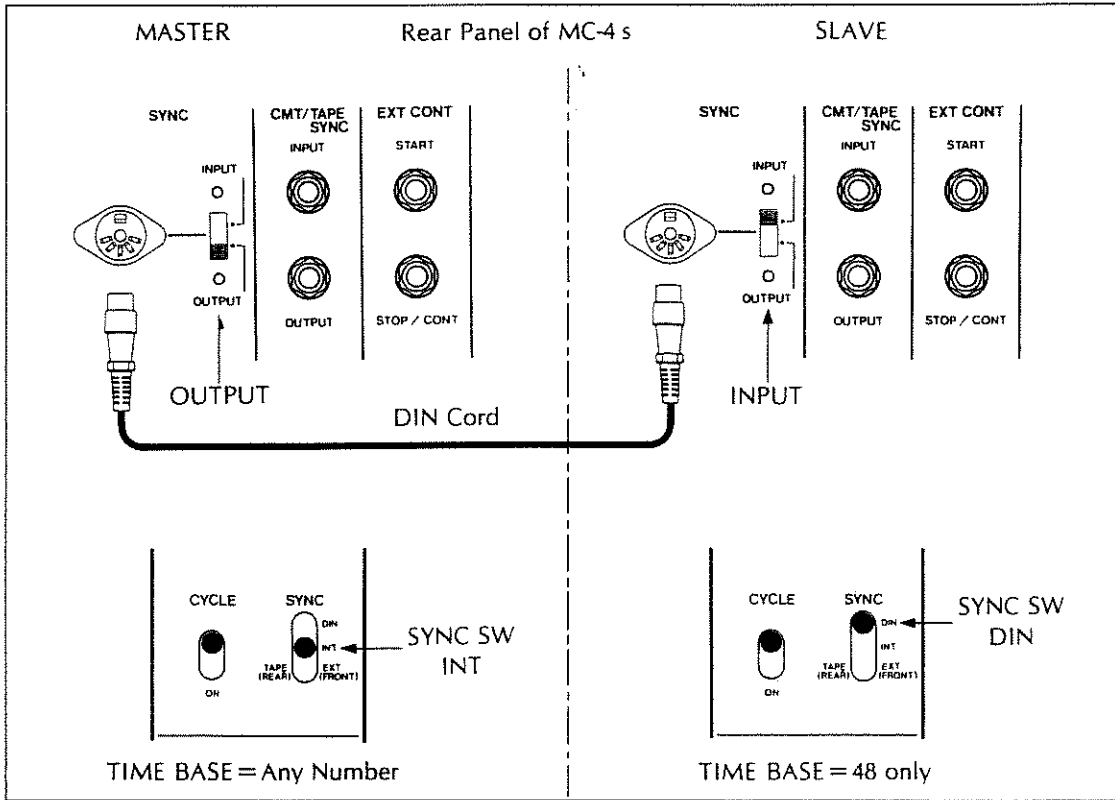
**DIAGRAM B-3:** SYNC from CSQ-600 to MC-4



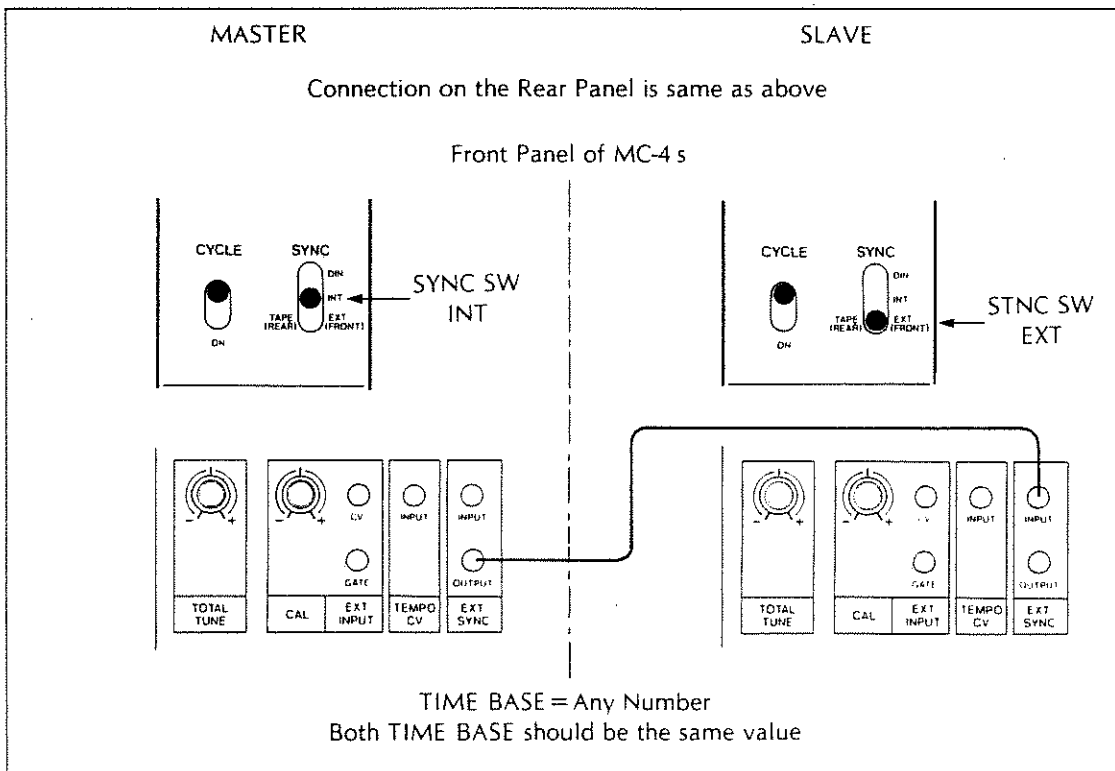
**DIAGRAM B-4:** SYNC from MC-4 to JP-8



**DIAGRAM B-5:** SYNC two MC-4s with DIN cord

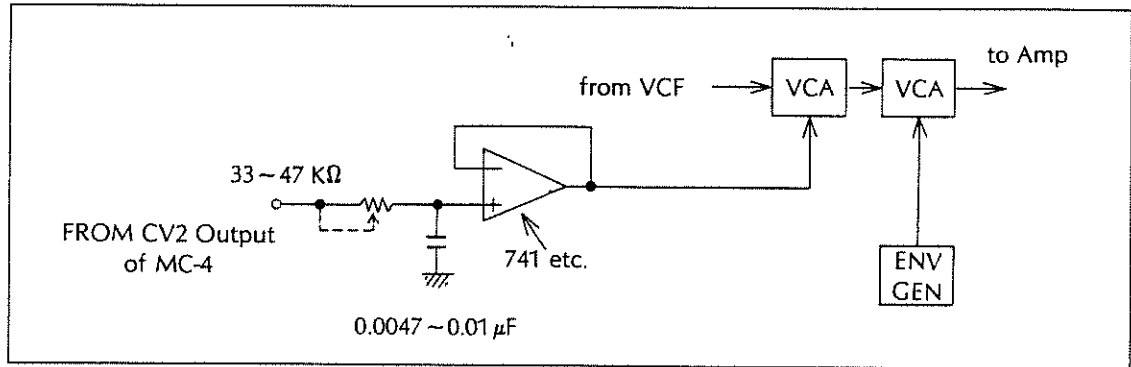


**DIAGRAM B-6:** SYNC two MC-4s with DIN cord and EXT SYNC

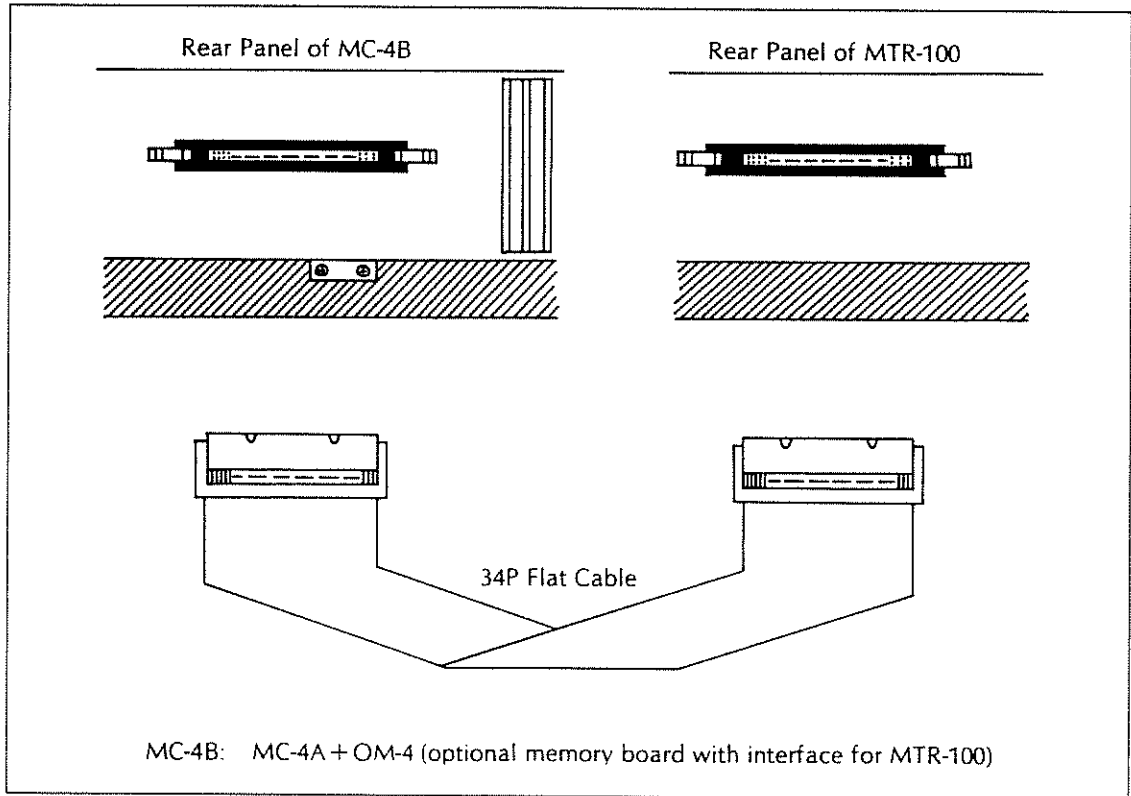




**DIAGRAM B-7:** A simple LAG CIRCUIT to soften CV 2 stepping transients when hook up to a VCA



**DIAGRAM B-8:** hook up to DIGITAL CASSETTE RECORDER MTR-100



# APPENDIX C

## USEFUL PROGRAMMING HINTS USING EXTENDED FUNCTIONS

This appendix will cover the remaining commands and functions not detailed in the opening chapters.

### C-1: LIMIT OF VALUES

First of all, here is a list of **minimum** and **maximum values** that may be entered into the MC-4's memory.

	<u>FUNCTION</u>	<u>MINIMUM</u>	<u>MAXIMUM</u>
1:	CV 1	0	125
2:	CV 2	0	125
3:	STEP TIME	1	61690
4:	GATE TIME	0	61690
5:	MPX	0	1
6:	TIME BASE	1	240
7:	TEMPO	1	240
8:	TB × TEMPO	92	20000
9:	CHANNEL	1	4
10:	MEASURE	1	61690
11:	STEP	1	61690
12:	BIAS	0	+ or - 240

## C-2: USING the CV 2 MEMORY

CV 2 main functions are the **control** of **dynamics** (volume), and **tempo**.

When the MC-4 is powered on, CV 2 memory is filled with a value of **50** which was chosen for 2 reasons:

a) When used for **VCA** control, this is a convenience which allows the **VCA** to be partially turned on so that the synthesizer will be **audible** when first entering **pitch data**. This assumes that **CV 2** is patched to a **VCA** which is being used to **control amplitude prior** to the **VCA** being used for **envelope control**.

b) When used for **tempo control**, this value **50** is the **center value**, which when patched to the **TEMPO CV INPUT** allows the MC-4 to play at the **tempo in tempo memory**. Any value other than this will change the **tempo**. A value of **25** gives **half** the tempo, and a value of **100** **doubles** the tempo. As a result, any type of tempo change may be **programmed**.

### 1: VCA—dynamics

When using **CV 2** to control a **VCA**, it is recommended that **CV 2** be lagged, by using a **slew rate limiter** which will **round off** the abrupt changes in voltage from the **CV 2** output. This will prevent clicks and thumps in the audio signal, and is easily implemented using a resistor-capacitor circuit which will act as a **low pass filter**. See **APPENDIX B**.

### LIST of POSSIBLE VALUES for VCA AMPLITUDE CONTROL

fff	100	or	80
ff	90		70
f	80		60
mf	70		50
mp	60		40
p	50		30
pp	40		20
ppp	30		10

## 2: Tempo Control

Using the **4 voice example** in **CHAPTER 3**, try some experiments with **CV 2** as a **tempo controller**.

Channels 2 & 3 are being used to play lines that have the same **STEP & GATE TIMES** as well as **dynamics**, so this frees up one of the CV 2 being used for dynamics. Patch **CV 2** of **chan 2** to the **dynamics VCAs** for parts 2 & 3. Then patch **CV 2** of **chan 3** to the **TEMPO CV INPUT**.

Enter new values for **CV 2** of **chan 3**. These may be any value between **1** and **125**. Try small values to start the piece and gradually increase the values towards the end of the piece. This will give a programmed **accelerando**. Try other CV 2 tempo values such as large values to start and small values to end. But do not use a value of **0** which will **stop** the TEMPO oscillator.

This time check the **playing time** by pressing **BK** key in the **PLAY** mode. The MC-4 will calculate the playing time, using the **tempo** values programmed in **CV 2**.

## 3: 2 VCOs

**CV 2** may be used to control other **VCOs**, so that it is possible to have up to **8** independant **itches** using **4** independant **GATE** channels. This is useful for **block harmony** and is like using **DIVISI** when writing for strings.

## 4: VCF—timbre

**CV 2** may also be used to control **VCFs** for **timbre**, or **tone**, by precisely controlling the filter cutoff frequency. Using **CV 2** to **VCA** and **VCF** together will allow more natural **dynamics**.

### C-3: USING the MPX OUTPUT

The **MPX** memory may be programmed with a 0 or 1 value and is useful for **switching & gating** functions on the synthesizer.

By using the **MPX** output for an **ADSR** gate, it is possible to have 2 independent voices on one channel. Use **CV 1** and **GATE** for the **first part** and **CV 2** and **MPX** for the **second part**. It will be necessary to do some planning here because the 2 parts will have common timing. A **simple rule** to follow is to make sure that there are more notes in the first part than in the second so that the first part may be given a 0 gate value for rests and the second part a **MPX** value of 1 as an **extra gate**. This way the first part won't sound while the second part will sound.

**Subdivide** the first part into as many smaller parts as required by using a very useful command which is itemized in **APPENDIX A-6: extended I**); which is the **divide data by a value** command. If, for instance, you wish to **sub-divide** a **1/4 note STEP TIME value of 120** into **1/16 note** values, then **BK** or **FW** to the **STEP TIME** value on the display. Press **IN DL 4 ME**, and the MC-4 will divide the **STEP TIME** value into **4 steps of 30 each** while calculating the correct **GATE TIME** value to total the **original GATE TIME**.

For example:

**STEP TIME = 120 GATE TIME = 90**

**Press IN DL 4 ME.**

There are now **four STEP TIMEs of 30 each** and **four GATE TIMEs of 30 30 30 0** to total **90**.

Now you may alter the **GATE** and **MPX** to program independent gate signals. This command is also useful for sub-dividing tempo & VCA values for smaller increments when using **CV 2**.

The **MPX** output may also be used to **switch voices** when using an analog gate. The best way to learn about the extended functions of **CV 2** and **MPX** is to experiment, and use your imagination to dream up new uses for these commands.

## C-4: ADDITIONAL COMMANDS

### 1: SHIFT 0

**SHIFT 0** will show the **percentage of memory remaining**. This can also be used as **clear entry** before termination.

### 2: SHIFT 6

In **GATE TIME** mode, this command changes **step number** to **step time** for the **STEP** position in the display. Pressing **SHIFT 6** again will go back. While displaying **step time** in **STEP** position, a **comma** indicates the **STEP** data as step time but not as step number.

### 3: SHIFT ENTER in EDIT MODE

This memorizes the measure and step currently displayed, as a **"marked"** position. When the **SHIFT** function (i.e; **0, 1, 2, 3, 4, 5, BK** and **FW**) is pressed, after stepping forward, back or modifying data, using **ENTER** or **ME**, the display will go back to the **marked** position. While **"marking"** the position, **'** appears to the right of the channel number. To cancel the **"marker"**, press **SHEN** again, or **CURSOR LEFT <** , or go to the **PLAY** mode.

### 4: TUNING

The **TUNE** function may be preset to a different value than the **default** value of 33, which would ordinarily correspond to a pitch of **A=440Hz**. To set the CV 1s in all channels to a temporary value of 24 for **middle C**, press **24 SH9**. To tune CV 2 , press **SH 4** then use **SH 9**.

### 5: PLAYING A PART

In the **PLAY** mode, the cycle function may be used to repeat a measure or group of measures by pressing the start measure number, then **ENTER**, end measure (default is end of music), **ME**.

**For example:** Play measures 1-4 of an 8 measure piece. Press **1 EN 4 ME**.

If **CYCLE** is **ON**, then 1-4 will repeat continuously, else 1-4 will play 1 time then stop.

To play 3-end, **press 3 EN ME**.

To play measure 4 only, **press 4 ME**.

# APPENDIX D

## DIGITAL CASSETTE OPERATING INSTRUCTIONS

The **ROLAND digital cassette recorder MTR-100** is offered as an optional accessory to the MC-4 so that programs may be saved and loaded with **much greater ease and speed** than is possible with a **standard audio cassette player**.

To use the **MTR-100**, the **MC-4** should have optional memory **OM-4** installed (called **MC-4B**). First follow the hookup diagram in **APPENDIX B**, then power on the **MC-4** and **MTR-100**.

### D-1: SET UP

First of all, it will be necessary to enter a program in the MC-4's memory. Use a short example.

Next, press the **eject button** on the **MTR-100** and insert a blank digital cassette tape. Do not close the lid on the recorder now.

Then press the **MODE** key to enter the **CMT** mode. The display will show:

SET TAPE

Close the lid on the **MTR-100**. The display will show:

D-CMT      SIDE A

or

D-CMT      SIDE B

If it shows **SIDE B**, wait until the tape is rewound then open the lid and turn the tape over and close the lid. This will change the display to **SIDE A**.

## D-2: INITIALIZING A CASSETTE

Before attempting to use the digital cassette to save programs, the cassette tape must first be initialized. This procedure is very simple, and is accomplished by using the following key-stroke:

Press **INS**. The display will show:                   INITIALIZE Y=ME

The reason why the MC-4 asks for a 'YES' response is to **prevent accidental erasure** of the programs that may already be recorded on the tape. The **initializing command erases** the entire tape on the side which is placed upwards in the cassette holder. To escape from initializing tape command, press **any key** except **ME**. The initialize process does not actually erase the tape, but simply creates the **end of file marker** at the beginning of the tape, and the MC-4 will record new data over any existing data.

Assuming that a **new tape** is installed in the unit and **INS** is pressed to show:

INITIALIZE Y=ME

then press **ME** to start the initializing process. The tape will run for several seconds then will rewind to the beginning.

The initialized tape is now ready to accept the following **SAVE**, **VERIFY** and **LOAD** commands. Then the display will show:

D-CMT     SIDE \*

The \* will be the side of the tape (**A** or **B**).

### NOTE:

Do not use **audio cassettes**. Be sure to use **certified digital cassettes!** ROLAND will guarantee operation with the **TEAC Computer Tape CT-300**, or **MAXELL Data Cassette Tape CT-300** or **M-90**.



### D-3: SAVING and VERIFYING A PROGRAM

The **SAVE** the program, press 7 (**SAVE**) 1 (file number) **ME**.

```
SU 1L
to
SV 1
```

The MTR-100 will run and the display will show the **SV 1** as well as the channel being saved. When finished, the display will show: **END1**  
and the **last channel number**, and the cassette will rewind to the beginning.

To **VERIFY** the program, press 8 (**VERIFY**) 1 **ME**.

```
VF 1L
VF 1
to
FN 1      :1
```

The display will show each channel as it is being **verified** and when finished will show:

```
OK 1      :*
```

The \* will be the last channel number in the program.

In the unlikely event of an **error**, the display will show:

```
ERR1      :*
```

If an **error** does occur, then **SAVE** the program again.

**NOTE:**

Do not use **audio cassettes**. Be sure to use **certified digital cassettes!** ROLAND will guarantee operation with the **TEAC Computer Tape CT-300**, or **MAXELL Data Cassette Tape CT-300** or **M-90**.

## D-4: LOADING THE PROGRAM

To **LOAD** the program, press **9 (LOAD) 1 ME**.

```
LD 1L
to
LD 1
```

When the program is found, the display will show:

```
FN 1      : 1
```

When finished loading, the display will show:

```
END1     : *
```

The program is now **LOADED** into memory and may be played by going to the **PLAY** mode. This is the **basic procedure for digital cassette operation**.

## D-5: ERASING PROGRAMS

Programs on a tape may be erased by using the following command;

Press **DEL**. The display will show: 

```
ERASE?      Y=ME
```

Again, the reason for this display is to ask if you really wish to erase files, to prevent accidental erasures. **Be careful in the use of the ERASE command! Any files following the file to be erased will also be erased!** To **escape** from erasing command, press any key except **ME**.

If you are certain that files should be erased, answer the display query as follows:

Press **ME**. The display will show: 

```
ER _
```

which is a prompt and means that the MC-4 is waiting for a file number. If you change your mind about erasing the file, press **CURSOR <** to escape the erase command.

Press (file number) **ME**. The tape will run, passing over any other files till it comes to the specified file number. The display will show: 

```
FN file number
```

Then the tape will run and stop. The display will show: 

```
END file number
```

The selected file will be erased and all subsequent files will also be erased, so **be very sure** of any erase commands used, and **as a rule of thumb, erase only the last file** on a **tape**.

## D-6: SAVING AN EDITED FILE

If a file is loaded from tape, then edited, and you wish to save the file again using the **same part of the tape**, there are a number of things to consider;

a) If the edited file is **shorter** or the **same length** as the original, then it may be **re-saved** using the same file number and will use the same part of the tape.

b) If the edited file is **longer** than the original, then there would be a possibility that the following **file(s) would be over written**, thereby erasing them.

c) If the original file is the last file on the tape, and the edited data, is **longer** than the original file, there is a possibility that the end marker will be over written and the remaining tape would become unusable.

A good rule to follow, if the edited file is longer than the original, is to rename the file, using a new number.

The procedure for re-saving an edited file using the original file number is as follows:

Press 7 (**SAVE**) the original file number **ME**. The display will show:

```
SAME NAME  Y=ME
```

The MC-4 is asking if you wish to record over the **old data**. To escape from the same name saving command, press **any key** except **ME**.

To answer '**YES**', Press **ME**. The display will show: SU \_

The MC-4 is waiting for a file number. When you wish to **write over** the **old data**, enter any file number (or the old number) and **ME**. The MC-4 will save the new file with the new name, writing over the old file.

If you decide not to chance erasing any subsequent files, simply press **CURSOR <** to escape from the **same name** saving function, then **press 7 (save) new** file number and **ME** as in **SECTION D-3**. The MC-4 will pass over **all** of the files on the tape and will save the edited file with the new number after the last file on the tape.

When **ME** is pressed after the question, if the display shows:

```
OVER      Y=ME
```

Press **any key** except **ME** to **escape**, (see b), c)), and save it with a new file number.

## D-7: SHIFT ME

In the previous sections, the **SAVE**, **VERIFY**, and **LOAD** commands were terminated with a **ME**. This causes the cassette to **rewind** to the **beginning** of the tape. Sometimes this is not desired, such as in the case of **copying** a tape, or **saving and loading files** that are smaller segments of a program that is to be **chained** or **joined** together into a complete program, or playing music in sequence of files on the tape.

### a) COPYING

When copying a tape to another tape, use the following procedure:

- 1: Press **MODE** switch, **CURSOR LEFT 5 times** < < < < <, and **DL, ME** to erase all data in the MC-4.
- 2: Press **MODE** switch twice to the **CMT** mode.
- 3: Load next file to be copied from the **original tape**, but use the **SHIFT ME (SHME)** key to terminate the **LOAD** command instead of **ME**. The file will load, but the tape will **not rewind**.
- 4: Insert a blank tape and **SAVE** the file. (Terminate with **SHME**.)
- 5: Repeat steps 1 to 4 until all of the files are copied.
- 6: After copying is finished, do not forget to **rewind** these tapes by pressing **DL DL** or **IN IN** etc.

### b) CHAINING

To chain files into **one large file**, use the following procedure:

- 1: Load the first file with **SHME**.
- 2: Load the remaining files with **SHME**.

Each of the files will be loaded in sequence to form a program consisting of all of the loaded files which may then be **saved**, using a **new file number**. This is very handy when working out a large composition which was programmed in small sections.

## D-8: CHANGING to the AUDIO CMT MODE

Press **CP**. Display will show: A-CMT MODE

To change from **A-CMT MODE** to **D-CMT**, press **MODE** switch 3 times.

## D-9: DATA PROTECTION

When you attempt to **SAVE**, **ERASE**, or **INITIALIZE**, if the tape is protected (with the small tab removed), the display will show:

PROTECTED

This prevents accidental erasure of important programs.

## D-10: DISPLAY FORMATS for the D-CMT MODE

In the D-CMT mode, the display tells the situations as follows:

DISPLAY	DESCRIPTION
D-CMT SIDE A	digital cassette mode
D-CMT SIDE B	digital side B
SET TAPE	
PROTECTED	write protection
INITIALIZE Y=ME	initialize the tape? ME for YES
SU _	save
SU 123_	
SU 123,4_	save only chan 4
SU 123	command accepted
SU 123 :1	saving chan 1
END123 :4	finished saving
SAME NAME Y=ME	same file name found on the tape
OVER Y=ME	data in MC-4 is larger
SU _	ME is pressed
TAPE END	end of tape, or end marker not found
UF _	verify
UF 123_	
UF 123	accepted
PS 4567	skip other files
FN 123	found the file
FN 123 :1	verifying chan 1
OK 123 :4	verified
E 123 :3	found error while VF, LD
ERR123 :4	errors are found after VF, LD
ERROR	digital cassette error
NOT FOUND	file is not found
LD _	load
LD 123_	
LD 123	accepted
FN 123 :1	loading chan 1
OV 123 :3	data is too large (MC-4 is full)
END123 :4	loaded file
ERASE? Y=ME	asking to erase, ME for YES
ER _	erase
ER 123_	
FN 123	found file to be erased

# APPENDIX E

## TECHNICAL SPECIFICATIONS

### Micro Composer MC-4

<b>Memory Capacity</b>	<b>MC-4A</b> [w/out OM-4] apx 3900 notes [16 K byte version] <b>MC-4B</b> [with OM-4] apx 12000 notes [48 K byte version]	
<b>** OM-4:</b>	optional memory board with interface for <b>MTR-100</b>	
<b>Output</b>	4 channels	each channel has:
	CV-1	[0V—10.42V, 125 steps, 83.3mV/step]
	CV-2	[0V—10.42V, 125 steps, 83.3mW/step]
	Gate	[off = 0V, on = 12V]
	MPX	[off = 0V, on = 12V]
<b>Ext Input</b>	CV	[0V—10.42V]
	Gate	[threshold + 2.5V]
	Calibration Knob	
<b>Tempo CV Input</b>	CV	[0V—10.42V]
<b>Ext Sync</b>	Input	[threshold + 2.5V]
	Output	[0—5V]
<b>CMT/Tape sync</b>	Input	
	Output	
<b>DIN Sync</b>	DIN socket	
	Selector [IN OUT]	
<b>Ext Control</b>	Start	
	Stop	
<b>Total Tune Knob</b>		[+/- 100 cents]
<b>Tempo Knob</b>		[-50% to +100%]
<b>Cycle Switch</b>		[ON OFF]
<b>Sync Selector</b>		[DIN INT EXT, TAPE]
<b>Mode switch</b>		[EDIT PLAY CMT]
<b>Keys</b>	Numeric [0—9]	
	Enter	(Start)
	Meas End	(Stop/Cont)

	Back Step	(total time), (—)	
	Forward step	(Step error), (+)	
	Shift		
	Insert		
	Delete		
	Copy	(Shift copy = transpose)	
	Repeat		
	Cursor <		
	Cursor >		
<b>Shift Map</b>	7: CV1 + GATE	8: GATE REWRITE	9: TUNE
	4: CV2	5: MPX	
	1: CV1	2: STEP TIME	3: GATE TIME
	0: Available Memory (%)		
<b>Dimensions</b>	471 x 348 x 124 mm		
<b>Weight</b>	6.1 kg (MC-4A), 6.3 kg (MC-4B)		
<b>Power</b>	30W		

**Digital Cassette Recorder MTR-100  
for use to MC-4B only**

<b>Memory Capacity</b>	4 pieces of full size music data / each side (250 K bytes / each side of a tape)
<b>Dimensions</b>	218 x 348 x 118 mm
<b>Weight</b>	3.4 kg
<b>Power</b>	30W
<b>Accessories</b>	Connection cable x 1 (to connect with MC-4B) Data cassette x 1

**Note:** MTR-100 can be used for the Microcomposer MC-4B only.

**\*\* Specifications are subject to change without notice. \*\***



## Command Summary

For more information, See **APPENDIX A**.

<b>Edit mode</b>	Time base	(1—240)	
	Tempo	(1—240)	
	Channel	(1—4)	
	Measure	(1—61690)	
	Step	(1—61690)	
	data — Enter	[data entry]	
	data — Meas End	[data entry with meas end]	
	keyboard	[data entry]	
	shift Meas End	[only meas end entry]	
	Back	[back step]	
	Fwd	[forward step]	
	shift Numeric	[1: CV-1, 2: step time, [3: gate time, 4: CV-2, 5: MPX]	
	Copy	[copy]	
	shift Copy	[transpose]	
	Ins	[insert a set of data]	
	Del	[delete a set of data]	
	Rep	[repeat begining]	
	Rep-Rep-times	[repeat end with times]	
	<b>Play mode</b>	Enter	[start]
		Meas End	[stop & continue play]
Back		[total time]	
Fwd		[step errors]	
<b>CMT mode</b>	7 — Numeric — Meas End	[save]	
	8 — Numeric — Meas End	[verify]	
	9 — Numeric — Meas End	[load]	
<b>Real time loading (in edit mode)</b>			
	shift 7 — n — Meas End	[CV-1 + Gate]	
	shift 8 — n — Meas End	[gate rewrite]	
	n:	metronome in each measure	
<b>Others (in Edit mode &amp; Play mode)</b>			
	shift 9	[tuning synth's]	
	shift 0	[memory remainder %]	

# MC-4 COMMAND SUMMARY

## A STRUCTURE

- 1 **MODE SWITCH** ..... A-2
- 2 **CURSOR KEYS** ..... 1C, 1D, A-2
- 3 **SHIFT MAP** 1: CV 1 2: STEP TIME 3: GATE TIME 4: CV 2 5: MPX ..... 1C, A-6

## B EDIT MODE

- 1 **TIME BASE**   
 a) ..... sets values ..... 1D, A-3   
 b) ..... deletes ALL data ..... A-3, D-7

- 2 **TEMPO**   
 a) sets TEMPO ..... 1D, 4I, A-4

- 3 **CHANNEL**   
 a) selects CHAN ..... A-5   
 b) goes to beginning ..... A-5   
 b) goes to end ..... A-5   
 c) deletes the CHAN ..... A-5   
 d) deletes the CHAN goes to beginning ..... A-5

- 4 **MEASURE**   
 a) selects MEAS ..... A-5   
 b) goes to beginning ..... A-5   
 c) goes to end ..... A-5   
 d) deletes meas's ..... A-5   
 e) deletes the meas ..... A-5

- 5 **STEP**   
 a) selects STEP ..... A-5   
 b) goes to step 1 ..... A-5   
 c) to just before ME ..... A-5

- 6 **DATA**   
 a) data entry ..... 1D, A-6   
 b) data with ME ..... 1D, A-6 (in CV 1 only)   
 c) same values ..... 1D, A-6   
 d) **keyboard** in CV 1, CV 2 only 4C, A-6   
 e) insert a ME ..... 1D, A-6   
 f) back a step ..... A-6   
 g) forward a step ..... A-6   
 h) selects DATA type A-6

- 7 **INSERT**   
 a) in CV 1 only ..... 3K, A-6   
 b) only ME ..... A-6

- 8 **DELETE**   
 a) ..... in CV 1 only ..... 3K, A-6   
 b) ..... deletes meas's ..... A-5   
 c) ..... deletes the meas ..... A-5   
 d) ..... deletes the CHAN ..... A-5   
 e) ..... deletes ALL data ..... A-3, D-7

- 9 **COPY**   
 a) ..... copies meas's ..... 3C, 4C, A-6   
 b) ..... copies the meas ..... A-6   
 c) **chan** - (same as above) ..... from another CHAN ..... 4C-5, A-6

<b>10 INSERT-COPY</b> inserts with copied data..... A-6	
<b>11 TRANSPOSE</b> a)  TR the data type meas's..... A-6 b)  TR the data type a meas..... A-6	
<b>12 TRANSFER</b> ST-GT CV1-CV2 a)  meas's..... 3H, A-6 b)  the meas..... A-6	
<b>13 REPEAT</b> a) ..... 3H, A-6 b) ..... 3H, A-6	c)  forward a meas..... A-9 d)  back a meas..... A-9
<b>14 DIVIDE/COMBINE</b> a)  divides by # times..... A-6 b)  combines # steps..... A-6	<b>16 others</b> a)  memory remainder..... 1D, A-6, C-4 b)  GT with ST..... A-6, C-4 c)  marker of MEAS STEP..... A-6, C-4 d)  forward CHAN..... 3I, A-6 e)  back CHAN..... A-6 f)  tuning..... 1A, C-4
<b>15 LIVE ENTRY</b> a) ..... 4C, 4D, 4F, 4H, A-9 b)  stops..... 4C, 4F, A-9	 
<b>C PLAY MODE</b>	
<b>1 PLAY</b> a)  start/stop..... 1E, A-7 b)  play meas's..... A-7, C-4 c)  play the meas..... A-7, C-4	b)  time of meas's..... A-7 c)  time of the meas..... A-7
<b>2 TOTAL TIME</b> a)  total playing time... A-7, C-2	<b>3 STEP ERROR</b> a)  step time errors:3K, A-7 b)  in meas's..... A-7 c)  in the meas..... A-7
<b>D CMT MODE</b>	
<b>1 SAVE, VERIFY, LOAD</b>  7 SAVE 2D, 3L, A-8, D-3, D-7 8 VERIFY 2E, A-8, D-3, D-7 9 LOAD 2F, A-8, D-3, D-7	<b>2 for DIGITAL CASSETTE</b> a)  INITIALIZE..... D-2 b) ..... D-5 c)  A-CMT MODE..... D-8





**Roland®**

---

**10183**

UPC 10183



10391

**Roland®**

## Free Manuals Download Website

<http://myh66.com>

<http://usermanuals.us>

<http://www.somanuals.com>

<http://www.4manuals.cc>

<http://www.manual-lib.com>

<http://www.404manual.com>

<http://www.luxmanual.com>

<http://aubethermostatmanual.com>

Golf course search by state

<http://golfingnear.com>

Email search by domain

<http://emailbydomain.com>

Auto manuals search

<http://auto.somanuals.com>

TV manuals search

<http://tv.somanuals.com>