

Roland

MIDI DIGITAL SAMPLER

MKS-100

Owner's Manual

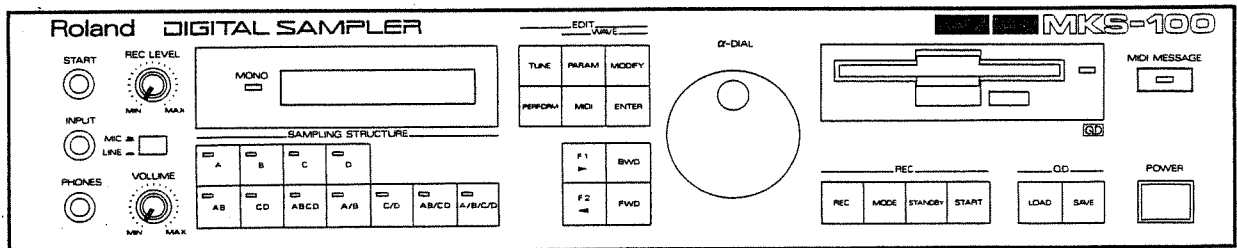

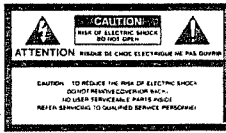

The lightning flash with arrowhead symbol, within an equilateral triangle, is intended to alert the user to the presence of un-insulated "dangerous voltage" within the product's enclosure that may be of sufficient magnitude to constitute a risk of electric shock to persons.



The exclamation point within an equilateral triangle is intended to alert the user to the presence of important operating and maintenance (servicing) instructions in the literature accompanying the product.

INSTRUCTIONS PERTAINING TO A RISK OF FIRE, ELECTRIC SHOCK OR INJURY TO PERSONS.

IMPORTANT SAFETY INSTRUCTIONS

WARNING When using electric products, basic precautions should always be followed, including the following:

1. Read all the instructions before using the product.
2. To reduce the risk of injury, close supervision is necessary when a product is used near children.
3. Do not use this product near water- for example, near a bath tub, washbowl, kitchen sink, in a wet basement, or near a swimming pool, or the like.
4. This product should be used only with a cart or stand that is recommended by the manufacture.
5. This product, either alone or in combination with an amplifier and headphones or speakers, may be capable of producing sound levels that could cause permanent hearing loss. Do not operate for a long period of time at a high volume level or at level that is uncomfortable. If you experience any hearing loss or ringing in the ears, you should consult an audiologist.
6. The product should be located so that its location or position does not interfere with its proper ventilation.
7. The product should be located away from heat sources such as radiators, heat registers or other products that produce heat.
8. The product should avoid using in where it may be effected by dust.
9. The product should be connected to a power supply only of the type described in the operating instructions or as marked on the product.
10. The power-supply cord of the product should be unplugged from the outlet when left unused for a long time.
11. Do not tread on the power-supply cord.
12. Do not pull the cord but hold the plug when unplugging.
13. When setting up with any other instruments, the procedure should be followed in accordance with instruction manual.
14. Care should be taken so that objects do not fall and liquids are not spilled into the enclosure through openings.
15. The product should be serviced by qualified service personnel when:
 - A: The power-supply cord or the plug has been damaged; or
 - B: Objects have fallen, or liquid has been spilled into the product; or
 - C: The product has been exposed to rain; or
 - D: The product does not appear to operate normally or exhibits a marked change in performance; or
 - E: The product has been dropped, or the enclosure damaged.
16. Do not attempt to service the product beyond that described in the user-maintenance instructions. All other servicing should be referred to qualified service personnel.

SAVE THESE INSTRUCTIONS

WARNING : THIS APPARATUS MUST BE EARTHED

IMPORTANT :The wires in this mains lead are coloured in accordance with the following code:
 Green-and-yellow : Earth
 Blue : Neutral
 Brown : Live

As the colours of the wires in the mains lead of this apparatus may not correspond with the coloured markings identifying the terminals in your plug, proceed as follows:

The wire which is coloured green-and-yellow must be connected to the terminal in the plug which is marked by the letter E or by the safety earth symbol \perp or coloured green or green-and-yellow.

The wire which is coloured blue must be connected to the terminal which is marked with the letter N or coloured black.

The wire which is coloured brown must be connected to the terminal which is marked with the letter L or coloured red.

Bescheinigung des Herstellers /Importeurs

Hiermit wird bescheinigt, daß der/die/das
ROLAND DIGITAL SAMPLING MODULE MKS-100
 (Gerät, Typ, Bezeichnung)

in Übereinstimmung mit den Bestimmungen der
 Amtsbl. Vfg 1046 / 1984
 (Amtsblattverfügung)

funk-entstört ist.
 Der Deutschen Bundespost wurde das Inverkehrbringen dieses Gerätes
 angezeigt und die Berechtigung zur Überprüfung der Serie auf Einhaltung
 der Bestimmungen eingeräumt.

Roland Corporation Osaka / Japan

Name des Herstellers/Importeurs

RADIO AND TELEVISION INTERFERENCE

*Warning - This equipment has been verified to comply with the limits for a Class B computing device, pursuant to Subpart J, of Part 15, of FCC rules. Operation with non-certified or non-verified equipment is likely to result in interference to radio and TV reception.

The equipment described in this manual generates and uses radio-frequency energy. If it is not installed and used properly, that is, in strict accordance with our instructions, it may cause interference with radio and television reception.

This equipment has been tested and found to comply with the limits for a Class B computing device in accordance with the specifications in Subpart J, of Part 15, of FCC Rules. These rules are designed to provide reasonable protection against such a interference in a residential installation.

However, there is no guarantee that the interference will not occur in a particular installation. If this equipment does cause interference to radio or television reception, which can be determined by turning the equipment on and off, the user is encouraged to try to correct the interference by the following means:

- Disconnect other devices and their input/output cables one at a time. If the interference stops, it is caused by either the other device or its I/O cable.

These devices usually require Roland designated shielded I/O cables. For Roland devices, you can obtain the proper shielded cable from your dealer. For non-Roland devices, contact the manufacturer or dealer for assistance.

If your equipment does cause interference to radio or television reception, you can try to correct the interference by using one or more of the following measures:

- Turn the TV or radio antenna until the interference stops.
- Move the equipment to one side or the other of the TV or radio.
- Move the equipment farther away from the TV or radio.
- Plug the equipment into an outlet that is on a different circuit than the TV or radio. (That is, make certain the equipment and the radio or television set are on circuits controlled by different circuit breakers or fuses.)
- Consider installing a rooftop television antenna with coaxial cable lead-in between the antenna and TV.

If necessary, you should consult your dealer or an experienced radio/television technician for additional suggestions. You may find helpful the following booklet prepared by the Federal Communications Commission:

"How to Identify and Resolve Radio-TV Interference Problems"
 This booklet is available from the U.S. Government Printing Office, Washington, D.C., 20402, Stock No. D04-000-00345-4

Please read the separate volume "MIDI", before reading this owner's manual.

Copyright © 1986 by ROLAND CORPORATION

All rights reserved. No part of this publication may be reproduced in any form without the written permission of ROLAND CORPORATION.

PANEL DESCRIPTION

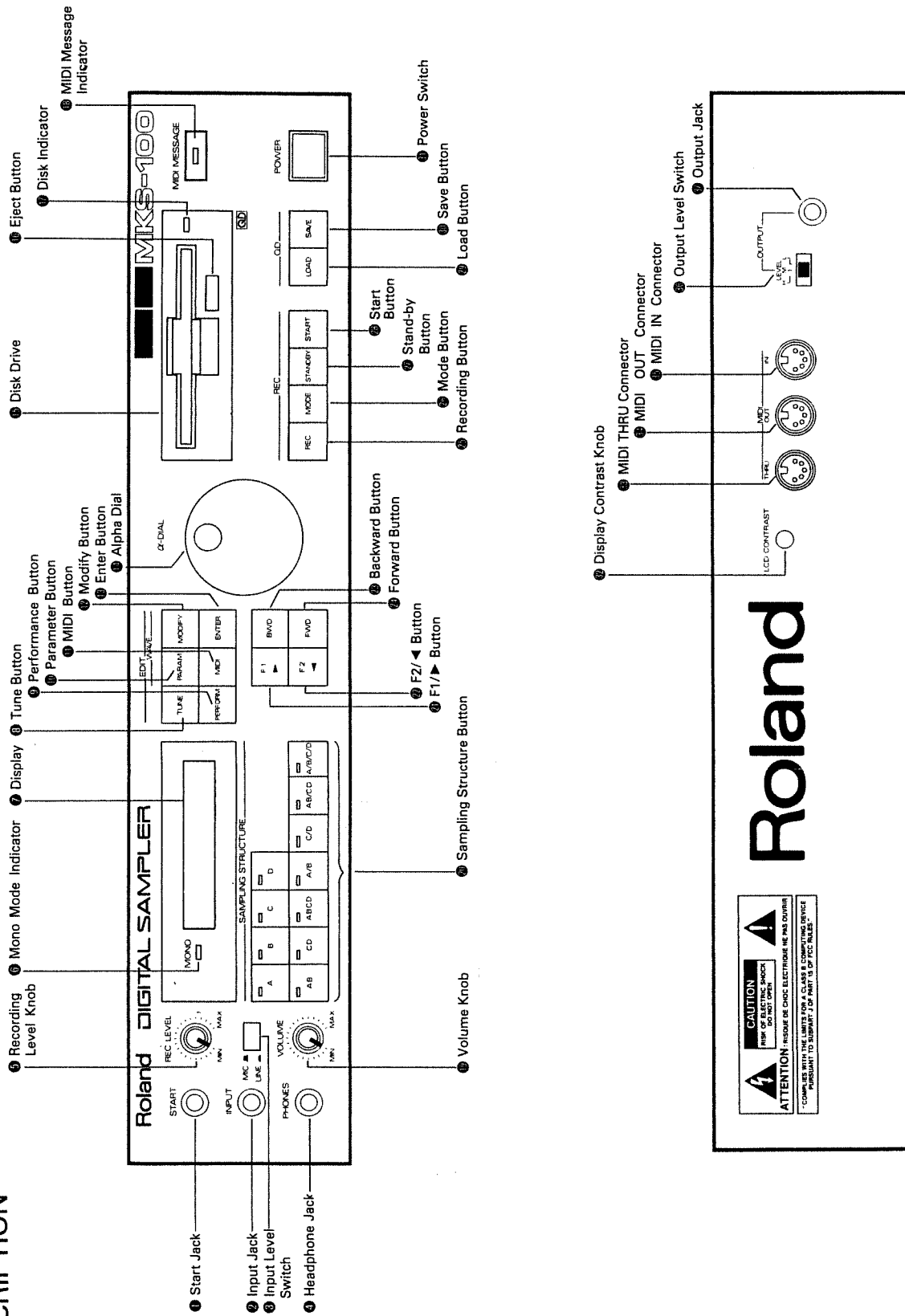

The Roland Digital Sampler is a completely new type MIDI Sound Module which can record (sample and record into computer memory) all sorts of sounds then play these sounds with the connected instrument.

The MKS-100 is conceptually like a tape recorder in that it records sound. However, the recording process is very different, since the MKS-100 is recording into computer memory. Computers can accept information only in digital signal so the MKS-100 converts audio signal into digitals. It does this by examining (sampling) the incoming signal level great many times a second, and sequentially recording these different levels in computer memory. This digital recording process is called SAMPLING.

IMPORTANT NOTES

- The appropriate power supply for this unit is shown on its name plate. Please make sure that the line voltage in your country meets the requirement.
- Please do not use the same socket used for any noise generating device (such as motor, variable lighting system).
- This unit might not work properly if turned on immediately after turned off. If this happens, simply turn it off and turn it on again in a few seconds later.
- Before setting up this unit with other devices, turn this unit and all the other units off.
- Use a soft cloth and clean only with a mild detergent.
- Do not use solvents such as paint thinner.
- Avoid using this unit in excessive heat or humidity or where it may be affected by direct sunlight or dust.

FEATURES

- The MKS-100 has four Banks (A, B, C and D) to record the sounds, therefore any of the four samples can be instantaneously selected.
- The MKS-100 features the dynamics function.
- The Split function allows to play two different sounds in the upper and the lower sound ranges.
- The sound you have recorded can be saved onto a 2.8 inch quick disk (QD) for future use.
- The liquid crystal display and the alpha dial serve to make the operation quicker and easier.
- The MIDI Mono Mode makes the MKS-100 useful for the GR Guitar System.
- The Roland Digital Sampling Keyboard S-10's Sound Library QD can be used for the MKS-100.

- Operating the unit near a neon, fluorescent lamp, TV or CRT Display may cause noise interference. If so, change the angle or the position of the unit.
- The built-in disk drive of the S-10 is a precision machine. So, please handle it gently. Specially while the Disk Drive is running, do not give a strong shock to the unit.
- The MKS-100 features memory back-up system that retains the data even when switched off. The battery that supports the back-up circuit should be replaced every five years. Call for the Roland service station for the battery replacement. (The first replacement may be required before five years, depending on how much time had passed before you purchased the unit.) Please make a memo of the data or save in on-to cartridge before having the MKS-100 repaired. There is no way for restoring the lost data.

CONTENTS

Panel Description	3
--------------------------------	---

1 Basic Operation

1. MIDI Setup	10
a. Connections	10
b. MIDI Mode Selection	11
c. MIDI Channel Setting	12
2. Loading from QD	12
a. Loading each of the four different sounds	12
b. Structure Buttons	14
c. Loading both sides of QD	17
d. Cancelling Structure setting before loading	18
e. Monitoring the QD data	18

2 Performance Controlling Functions

1. Editing Performance Parameters	19
2. Performance Controlling Functions Determined by Performance Parameters	21
a. Vibrato	21
b. Pitch Bend	22
c. Arpeggio	23
d. Trigger Play	24
e. Detune	27
f. Delay	28
g. Dual Function	29
3. Performance Controlling Functions unrelated with Performance Parameters	31
a. Pedal Hold	31
b. Tuning	32
c. Changing Split Point	32
4. Performance Parameters for loading	33

3 Sampling

1. Basic Sampling	34
2. Changing Sampling Conditions	36
3. Sampling a Long Tone or Split	37
4. De-activating Looping	38

4 Correcting the sampled data

1. Editing Wave Parameters	39
2. Changing Looping	41
3. Tuning a Sample	42
4. Scanning Mode	43
5. Start Point	43
6. Key Follow	44
7. Envelope	44
8. Dynamic Sens	47
9. Pitch Bender On/Off	47
10. Vibrato On/Off	47
11. Auto Bend	47
12. Copying Wave Parameters	48
13. Structures and the Wave Parameters	49

5 Saving

1. Basic Saving	50
2. Quick Saving without Verification	52

6 Wave Modification

1. Level Adjustment	54
2. Reverse	55
3. Auto Loop	56
4. Copy	57
5. Swap	58
6. Digital Filter	59
7. Mix	61
8. Combine	62

7 MIDI

1. Changing MIDI Functions	66
2. Program Change	68

8 Error Messages

Disk Memo	72
------------------------	----

Specifications	81
-----------------------------	----

How to handle the Quick Disk (QD)

The sampled sound on the MKS-100 can be saved onto a 2.8 inch double sided quick disk.

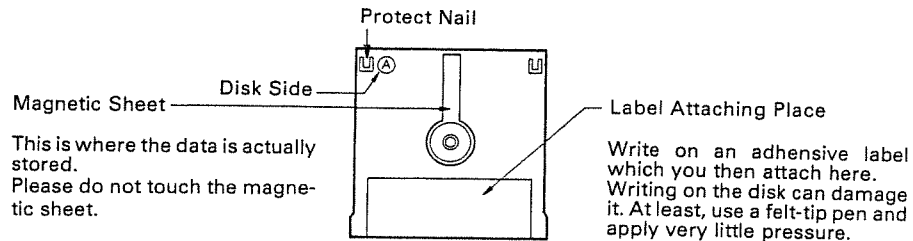

- Please do not touch the magnetic sheet, or the disk may become damaged.
- Do not fold or bend the disk.
- When the disk is not to be used, preserve it vertically in the supplied protective jacket. Do not keep it on a slant or bending shape
- Keep the disk from extremely hot or cold temperatures, dust or direct sunlight.
- Do not expose the disk to strong magnetic field such as headphones or speakers.
- Take out the protection sheet inserted in the disk drive, by pushing the Eject Button . In transit, reinsert the sheet into the drive.
- Please be sure to put the MKS-100 on a steady and horizontal place.
- Never remove or insert the disk, switch the MKS-100 on or off while the indicator of the disk drive is lit, or the disk may be permanently damaged.
- Please be sure that the label is securely attached to the QD, or the label may come off in the disk drive, making it difficult to take it out.

Protect Nail on the Disk

- To protect the data saved on the disk from an accidental loss or overrecord, snap off the Protect Nail on the disk. This way, the disk can be no longer used for backup, but the data can be read from the disk just the same. The nail is provided for each side A and B.

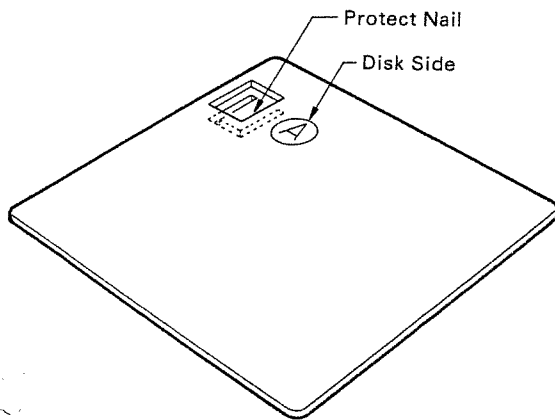

- If you wish to use the disk again for saving other data, stick a selophane adhesive tape as shown below.

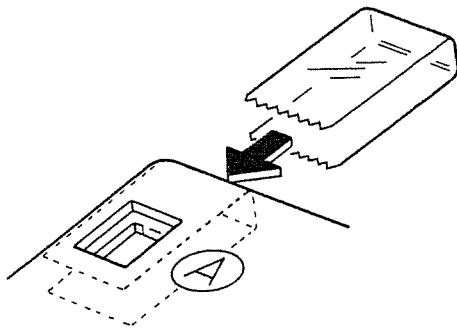

OUTLINE OF THE MKS-100

The MKS-100 can sample all sorts of sounds and record them into the built-in computer memory as digital data. This digital data can be used to play various sounds. In other words, when no digital data is recorded in memory (right after the MKS-100 is turned on for the first time), there is no sound heard from it.

To play the MKS-100, you must record sounds or load back the data saved on the quick disk (QD).

Using the QD's sound library, the MKS-100 can be played as a high quality, preset type MIDI sound module (The S-10's sound library QD can be used for the MKS-100) even without recording any sound.

The MKS-100 is the sound module that is played by the MIDI signal sent from the external MIDI device. More than one MIDI message can be received by the MKS-100 using different MIDI Channels from 1 to 16.

Also, the MKS-100 can select the MIDI Poly or Mono mode. The MIDI Poly mode allows to receive more than one MIDI message on one channel, and the MIDI Mono mode allows one message on one channel. In other words, in the Poly mode, the MKS-100 is 8 voice polyphonic sound module which can be used with a MIDI sequencer or keyboard. In the Mono mode, the MKS-100 is the 8 sets of monophonic sound modules which use 8 MIDI channels. The Mono mode is effective for using the GR-Guitar System (interfaced with the MIDI-Guitar Converter): the signal from each string can be received separately, allowing realistic guitar sound without spoiling its characteristic.

* The Roland past Guitar Synthesizers (e.g. GR-700, GR-77B) provides only the MIDI Poly mode.

The MKS-100's Mono mode does not allow to set a different sound for each note separately. This is because each channel is not perfectly independent. The Note Message (e.g. pitch, volume) and the Bender message (guitar's choking), however, are independent.

If the MIDI Mono mode is not correctly selected, the MKS-100 will not operate properly, such as the chord is not played, etc. Please check the type of the device that controls the MKS-100, and set the MKS-100's MIDI Mode correctly.

1 Basic Operation

1. MIDI Setup

a. Connections

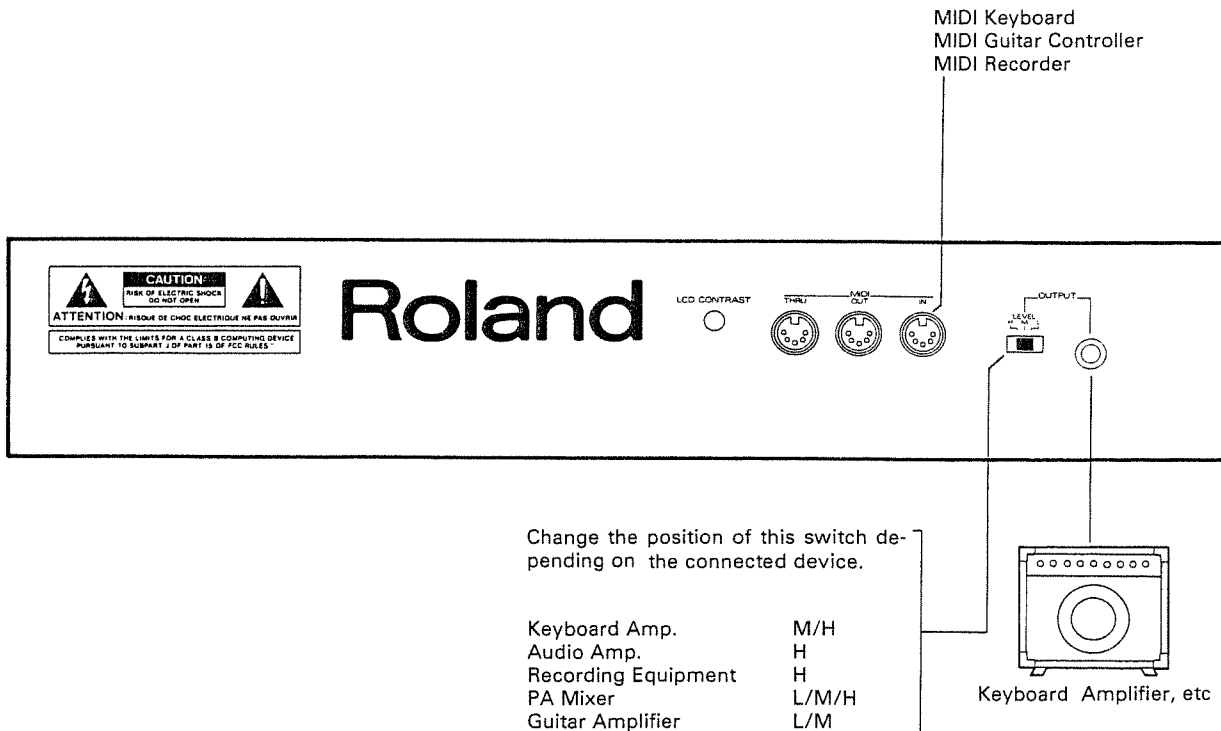
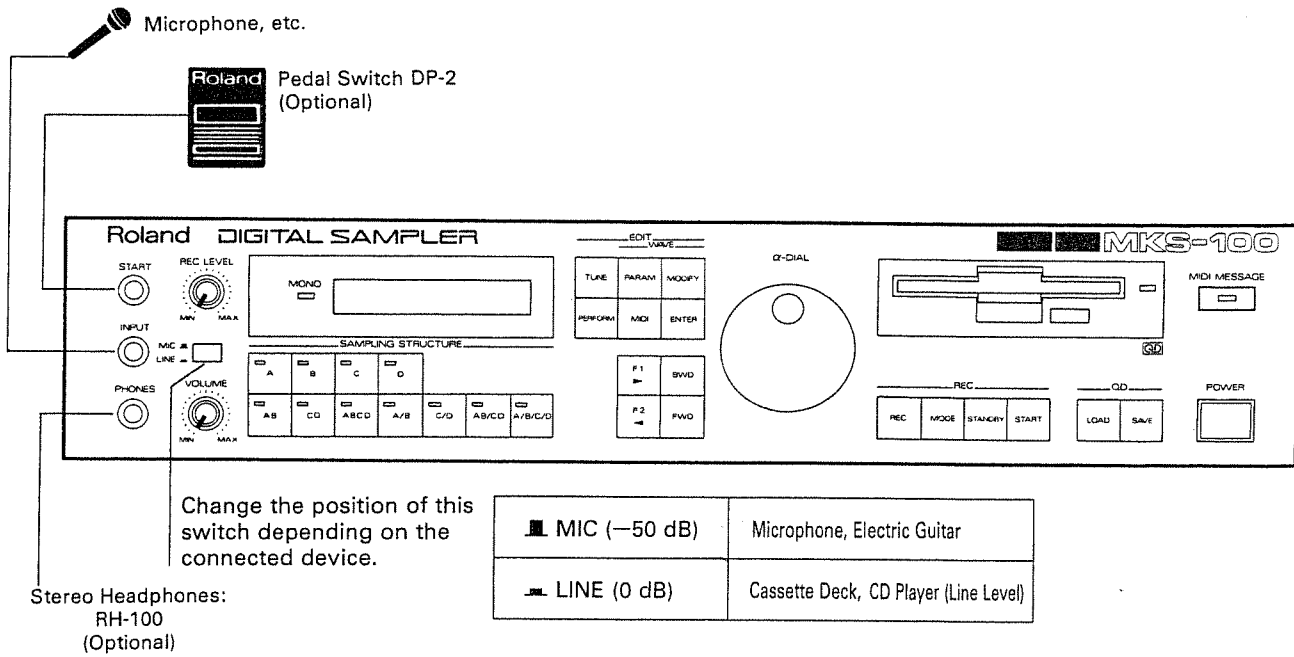

- ① Connect the MIDI OUT connector on the transmitter (controller) to the MIDI IN ⑤ on the MKS-100 using the supplied MIDI Cable.
- ② Connect the Output Jack ⑦ on the MKS-100 to the input jack on the amplifier using the supplied audio cable.
- ③ Turn on the MKS-100, transmitter MIDI device then the amplifier.

When the MKS-100 is turned on, the Display responds with:

R o l a n d M K S - 1 0 0

In a few seconds, the Display changes to:

R e a d y

If necessary, adjust the contrast of the Display using the Contrast Knob ⑫.

b. MIDI Mode Selection

The MKS-100 is released from the manufacturer in the Poly mode default. If using the MIDI-Guitar Converter, change it to the Mono mode as follows before going to the next section "c. MIDI channel setting".

- ① Push any of the Structure Buttons ⑳, then the MIDI Button ①.

M I D I C H A N N E L = 1

- ② Push the Forward Button ② seven times to call "MIDI Mode" in the Display.

M I D I M O D E = P O L Y

- ③ By rotating the Alpha Dial ⑬, change the Display from "POLY" to "MONO".

M I D I M O D E = M O N O 8

The Mono Mode Indicator ⑥ lights up.

The number at the far-right of the Display represents how many voices the MKS-100 can output at a time (4 or 8 voices). Refer to "MIDI Mode" on page 67.

* When the Mono mode command is sent from the external MIDI device, the MKS-100 will be set to the Mono mode and the Mono Mode Indicator will light up.

- ④ Push the Enter Button ⑮.

The MIDI Mode setting is retained in memory even after the unit is turned off.

c. MIDI Channel Setting

The MIDI channels of the connected units should be set to the same number. Unless the MKS-100's receive MIDI channel is set correctly, the necessary MIDI messages cannot be received, therefore, the MKS-100 cannot be played properly.

- ① Push any of the Structure Buttons ⑳, then the MIDI Button ㉑.

MIDI CHANNEL = 1

- ② By rotating the Alpha Dial ㉒, set the receive MIDI channel of the MKS-100 to the same number of the transmit MIDI channel of the external device.

- ③ Push the Enter Button ㉓.

If the MIDI channel is set correctly, the Note On signal sent from the transmitter will light up the MIDI Message Indicator ㉔ on the MKS-100.

When the MKS-100 is set to the Mono mode, set the lowest MIDI channel to be used (=basic MIDI channel), and the following numbers will be automatically assigned up to the 8 channels.

- * The MIDI channel higher than 17 will be ignored, therefore cannot receive message.

The MIDI-Guitar Converter is designed to transmit MIDI signal to each string separately; the MIDI channel you set (=basic channel) is assigned to the 1st string, that plus on to the 2nd string, that plus two to the 3rd string, and so on. For instance, if you set the MIDI channel 2, it is assigned to the first string, channel 3 to the second string, channel 4 to the third string and so on up to the channel 7 to the sixth string.

The MIDI channel you have set will be retained in memory even after the MKS-100 is turned off.

2. Loading from QD

First of all, load the data from the supplied disk to the MKS-100's internal memory, and listen to the sounds.

One side of the disk contains one sound, i.e. two sounds on one disk. The MKS-100's internal memory can store up to two disk data which is four different sounds.

Both A and B sides of a disk may be used for one sound.

a. Loading each of the four different sounds

- ① Insert the supplied quick disk #001 "Drum Set" into the disk drive with the A side (BD) facing upward.

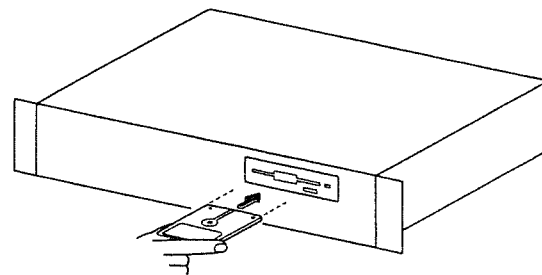

(Please gently hold the sides of the Disk with your thumb and forefinger, then slowly insert it.)

- ② Push the Load Button ㉔.

- * Usually for loading, the Load Button should be pushed after inserting the disk. However, if it is inserted while "READY" is still shown in the Display quickly after the MKS-100 is switched on, pushing the Load Button is not necessary.

During loading, the Display will respond with:

Load BASS DRUM

While the disk drive is running, the disk drive indicator is lit without fail. **This is to warn you not to remove or insert a disk. That would break the disk or erase the data.**

After a while, the Display will change as shown below.

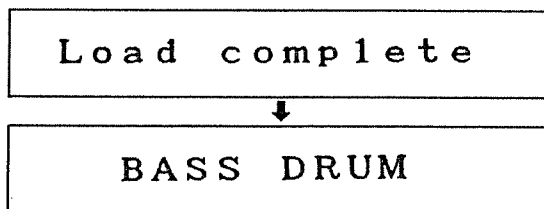

This shows that the sound saved on the side A (BD) of the disk is loaded to the MKS-100. Also, the indicator of the Structure Button A is lit. Now, you can hear Bass Drum by sending MIDI Note on message.

③ Make sure that the disk drive indicator is dark, push the Eject Button , remove the QD and reinsert it into the disk drive with the side B (SD) facing upward this time.

④ Push the Load Button  .

Likewise, load the C (TOM) and the D (HH) sides of the "Drum Set" disk.

Now, four different sounds are loaded into the MKS-100's internal memory.

By pressing the Structure Buttons A, B, C or D, you can select any of the four sounds. We regard these A, B, C and D as locations where the sounds reside. Each Bank can retain the sound data of one second as longest. To make a sustained sound, you may loop the sampled sounds. (See page 41.)

* The key you play on the keyboard may sound in a shifted pitch. This is because of the Recording key Number. (See page 36).

b. Structure Buttons

The Structure Buttons A, B, C and D are used to select the corresponding sound of the Banks A, B, C and D. These Banks can be recorded or played simultaneously or sequentially by using other Structure Buttons. This is effective for combining two Banks for recording a long tone, etc.

1) Structure AB, CD (ABCD)

The Structure AB can be used for joining the Bank A sound with the B sound. Likewise, the Structure CD button joins the C and D. This is useful for combining two banks for sampling two second sound. You may also combine two different samples and play it.

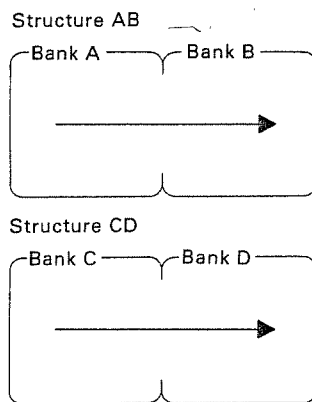

The Structure ABCD plays (or records) the Banks A, B, C, and D sequentially.

If this Structure ABCD is used for playing the "Drum Set", the volume of the later sound will be very low. This is because of the Wave Parameters (explained later).

2) Structure A/B, C/D

The Structure A/B button plays the Bank A sound in the lower sound range and the Bank B sound in the upper. The C/D button works just like that, playing each sound separately in the lower and upper sound range. The MKS-100 allows you to divide the whole sound range into two sections and assign different sounds to each range. Split Point is the dividing line of the two sections.

* The actual Split Point of the "Drum Set" is different from the following picture.

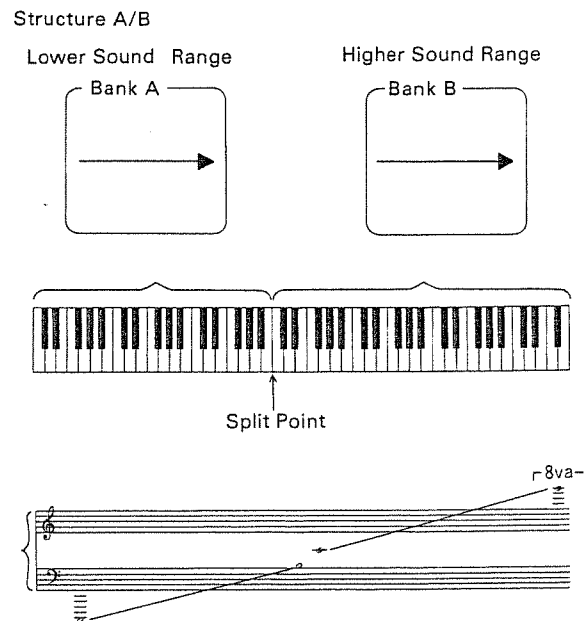

3) Structure AB/CD

The Structure AB/CD button plays the Bank A sound then the B sound in the lower section, while the D sound is followed by the C in the upper section.

Structure C/D

Lower Sound Range

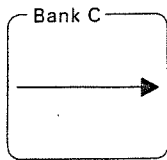

Higher Sound Range

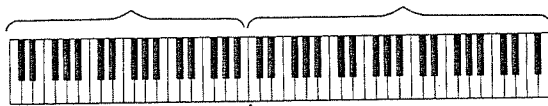
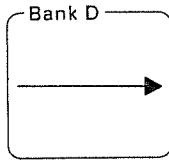

Split Point

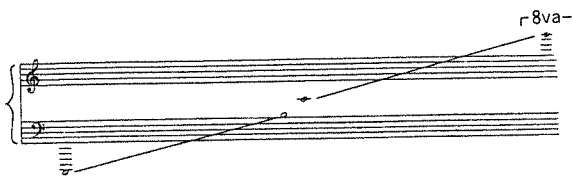

Structure AB/CD

Lower Sound Range

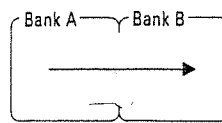

Higher Sound Range

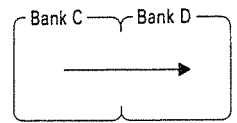

Split Point

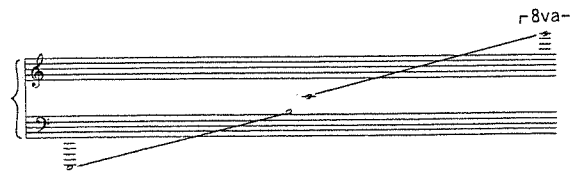

4) Structure A/B/C/D

The Structure A/B/C/D button splits the MKS-100 to four sound ranges, and play each Bank sound A, B, C and D in the four sections separately.

Structure A/B/C/D

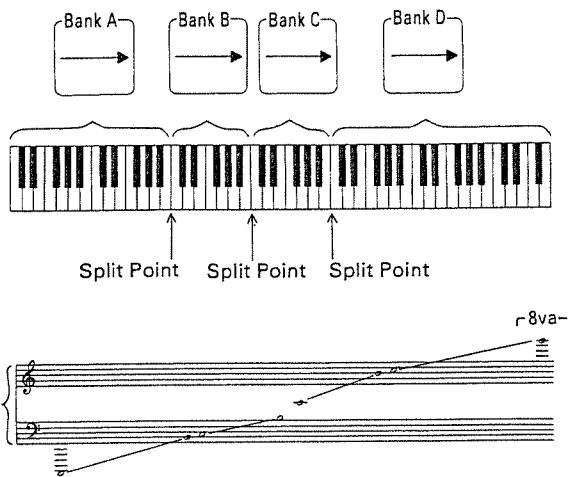

These Split Structures are specially useful to create piano sound whose tones subtly vary in higher and lower notes.

5) Note on Sampling Structure



The QD includes the data of the sampling structure. When the loading is completed, the relevant indicators on the panel will light up to tell you which structure is used.

When the Banks of two different sounds are combined, the pitches or volumes of the two sounds may differ. This is related with the Wave Parameter explained later in this manual.

c. Loading both sides of QD

Some data consists of more than one Bank, therefore, saved on both sides of a QD or even on a few sets of QD's. For instance, "STRINGS" of the QD#002 "STRINGS & CHORUS" which is structure A/B, is saved on both sides A and B of the QD. That is, to play this, you should load both sides of the QD.

PROCEDURE

- ① Make sure that the disk drive indicator is dark, push the Eject Button  and take out the QD.
- ② Insert the #002 QD with the A side facing upward, and push the Load Button .

L o a d S t r i n g s

When the side A is loaded, the Display will change to:

c h a n g e Q D

The Display tells you that the data on the side B is required.

- ③ Make sure that the disk drive indicator is dark, push the Eject Button  and take out the QD.

The Display will respond with:

I n s e r t Q D

- ④ Re-insert the QD with the B side facing upward, and loading will automatically start.

L o a d S t r i n g s

When the both sides of the QD are loaded, the MKS-100 is ready to play (Play Mode) in the relevant structure.

S t r i n g s

In the Play mode, the Display shows the sound name.

The Banks C and D are still empty. You may, if necessary, load the Banks C and D or structure C/D. Insert the relevant QD and push the Load Button .

If you notice that you are using a wrong disk during loading. Wait until the disk drive indicator goes out, push any of the Structure Buttons . This will stop loading and return to the Play mode. Change the disks and repeat the loading procedure.

About Error

When a set of data (both sides of a QD or even two QD's) is supposed to be loaded, but you try to load the data irrelevant to the one loaded before, the Display will respond with:

W r o n g Q D

Take out the disk and insert the appropriate one in a right direction, and the loading will start.

d. Cancelling Structure Setting before Loading

It is possible to load one of the set data (e.g. Bank B of the Structure A/B) to a different Bank (e.g. Bank C). This, however, may cut the sound, because the original Structure is ignored in this way.

Push the Structure Button A, B, C or D where you wish to load the data, and without releasing it, push the Load Button ④ .

e. Monitoring the QD Data

You can monitor the contents of the QD; such as Sound Name or Structure setting.

- ① Insert the relevant QD.
- ② Push the F1 Button ④ , then the Load Button ④ .

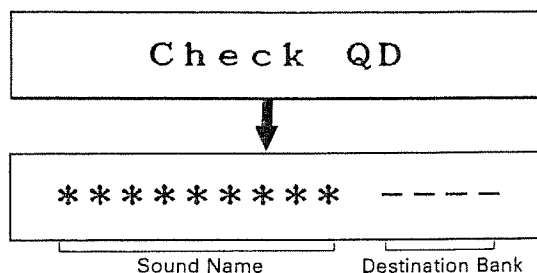

The Display shows the Sound Name and the Bank where the sound is to be loaded. Also, the Structure setting can be seen on the Structure Indicator ④ .

While the above indication is shown in the Display, the data is not yet loaded.

To load the data you are now monitoring in the Display, push the Load Button ④ .

To monitor other disk, make sure that the disk drive indicator is dark and change the disks. Inserting the disk will automatically monitor the data.

If you do not want to load the data you have monitored, push any of the Structure Button ④ , and the MKS-100 will return to the Play mode.

2 Performance Controlling Functions

The MKS-100 features various functions for controlling performance, such as pitch bender, vibrato and auto arpeggio.

The performance controlling functions can be easily engaged by using the buttons on the panel.

Most of the performance controlling functions consist of Performance Parameters, and the effect of the function can be altered by changing the value of each parameter.

1. Editing Performance Parameters

To change the preprogrammed value of each parameter, take the following procedure.

- ① Push the Performance Button **9**.
- ② By using the Forward Button **24** and the Backward Button **23**, call the performance parameter you wish to edit with the aid of the Display window.

VIB RATE = 64

- ③ By rotating the Alpha Dial, change the value of the parameter.

The number shown at the right of the Display will change as below.

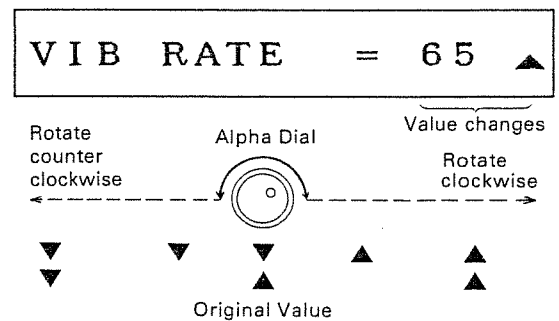

If you wish to edit other parameters, repeat the steps ② and ③.

- ④ Push the Enter Button **18**.

The performance parameters will be always called in the sequence as shown below.

Performance Controlling Function	Display	Performance Parameter
Vibrato	VIB RATE	Vibrato Rate
	M-VIB DPTH	Manual Vibrato Depth
	D-VIB DPTH	Delay Vibrato Depth
	D-VIB DLAY	Delay Vibrato Delay Time
Bender	{ BEND MODE	Bend Mode
Arpeggio	ARP SYNC	Arpeggio Sync Mode
	ARP RATE	Arpeggio Rate
	ARP MODE	Arpeggio Mode
	ARP RANGE	Arpeggio Range
	ARP REPEAT	Arpeggio Repeat
	ARP DECAY	Arpeggio Decay
Velocity Mix	{ V-MX THRSH	Velocity Mix Threshold
Velocity Switch	{ V-SW THRSH	Velocity Switch Threshold
Detune	DTUN MODE	Detune Mode
	DTUN RANGE	Detune Range
	ABEND DEST	Auto Bend Destination
	BEND DEST	Pitch Bend Destination
Delay	DELAY TIME	Delay Time
	DELAY LEVEL	Delay Level
	KEY OFFSET	Key Offset
Trigger Play	TRG G-TIME	Gate Time
	Ext Gate Play	Trigger Play

You can edit the parameters while actually listening to the sound, but the change cannot be heard unless you stop playing the MKS-100 once then play it again.

2. Performance Controlling Functions determined by Performance Parameters

a. Vibrato

Receiving the MIDI Modulation message (caused by operating the modulation lever/wheel on the keyboard), the MKS-100 will create Vibrato effect. This is called "Manual Vibrato".

"Delay Vibrato" is the vibrato that does not come on immediately but comes on after a certain time has elapsed.

To control these vibrato effects, the following four performance parameters are involved.

- **Vibrato Rate**

```
VIB RATE = 64
```

This sets the rate of the vibrato from 0 to 127.

- **Manual Vibrato Depth**

```
M-VIB DPTH= 32
```

This sets the depth of the manual vibrato from 0 to 127.

When the MIDI Modulation of the MIDI Functions is set to OFF, the MIDI Modulation message will be ignored, therefore, the Manual vibrato cannot be obtained.

- **Delay Vibrato Depth**

```
D-VIB DPTH= 0
```

This sets the depth of the delay vibrato from 0 to 127.

- **Delay Time of the Delay Vibrato**

```
D-VIB DLAY= 64
```

This sets the time needed for the delayed vibrato to come on from 0 to 127.



If the vibrato in the Wave Parameter (explained on page 47) is set to OFF, the sound would not take on vibrato at all.

b. Pitch Bend

When the MKS-100 receives the MIDI Pitch Bend message (caused by operating the bender on the keyboard or guitar's choking), it creates the Pitch Bend effect.

Bend Range

The depth of the pitch bend effect can be set with the Bend Range.

- ① Push the F1 Button , then the Performance Button .
- ② Using the Alpha Dial, change the value of the Bend Range.

The Bend Range can be set in semi-tone steps from 0 to 12 (one octave).

BEND RNG=12 [9]

- ③ Push the Enter Button.

The MKS-100 cannot play the pitch higher than the sampled sound by one octave and 6th (21 semi-tones). The exceeded pitch will be substituted with the pitch of the lower octave.

The number shown at the right of the Display represents how many notes (semi-tones) higher than the pitch of the sample (Recording Key Number) can be output from the MKS-100. As you raise the Bend Range value, the number becomes smaller.

- * The Bend Range Value you have set will be retained in the MKS-100's memory, but cannot be retained in the QD.

If the Bender of the Wave Parameter (explained on page 47) is set to OFF, the sound would not take on the pitch bend effect.

If the MIDI Bender of the MIDI Functions (explained on page 66) is set to OFF, the MIDI Pitch Bend message is ignored, therefore, the pitch bend effect cannot be obtained.

• Pitch Bend Mode

BEND MODE =CONT

The Pitch Bend message can function in various ways as shown in the table below.

Mode	Display	Description
Normal (Continue)	CONT	Usual smooth pitch bend.
Chromatic	CHRM	Chromatic pitch bend.

One performance parameter is involved with the Pitch Bender.

c. Arpeggio

When a Chord Key On signal is received, the chord can be arpeggiated.

Arpeggio ON/OFF

- 1 Push the F2 Button **22**, then the Performance Button **9**.

ARPEGGIO = ON

- 2 Select ON or OFF with the Alpha Dial **14**.
- 3 Push the Enter Button **18**.

***** A

When the Arpeggio is set to ON, the Display shows "A" at the far right, and a chord will be arpeggiated.

Six performance parameters are involved with the Arpeggio:

- * When the MIDI Mono mode is selected, the Arpeggio does not work.

- **Arpeggio Rate**

Pushing the Parameter Button **9** during arpeggio performance will cause the Display to show Arpeggio Rate.



ARP RATE = 64

Set the rate of the arpeggio.

- **Arpeggio Mode**

ARP MODE = UP

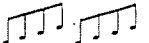
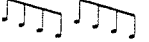
Set the shape of the arpeggio.

Mode	Display	Description
Upward	UP	
Downward	DOWN	
Up and Down	U/D	
Random	RND	Plays the pressed keys at random.

- **Arpeggio Range**

ARP RANGE = 1 oct

This sets how many octaves should be used for the arpeggio performance from 1 to 3 octaves.

- **Arpeggio Repeat**

ARP REPEAT = 1

This sets how many times each note of the chord should be played from 1 to 16 times.

- **Decay**

ARP DECAY = 10

At 1, the arpeggio decays fastest and at 10, it is sustained in a set volume.

When the Dynamics Sens of the Wave Parameters (see page 47) is set other than 127, the decay effect cannot be completed.

- **Arpeggio Sync Mode**

ARP SYNC = INT

This selects whether the arpeggio should play on its own or sync to the external device.

Mode	Display	Description
Internal Clock	INT	Internal clock controls arpeggio performance.
External Trigger	EXT	Every external trigger plays one step of Arpeggio.

- **External Trigger Mode**

In this mode, the external trigger signal (audio or pulse) fed into the Input Jack ② will play each note of the chord. Every trigger signal plays one of the keys you are pushing on the keyboard in the sequence of as the Arpeggio Mode is set.

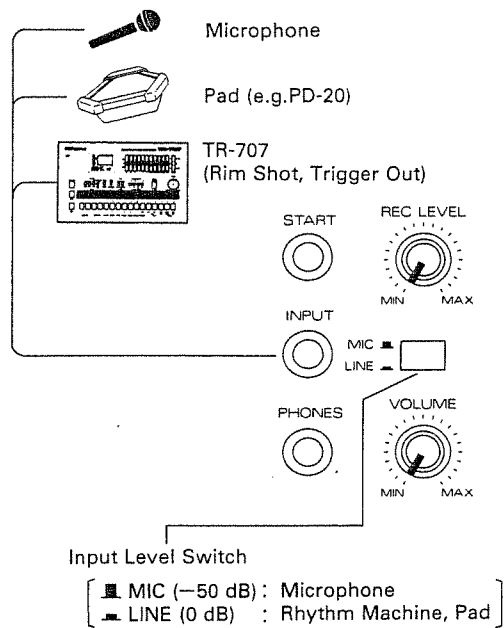

Set the Input Level Switch ③ and the Recording Level Knob to the positions which allow the most stable action.

► By connecting the optional Pedal Switch DP-2 to the Start Jack ①, pushing the pedal can play each note of the arpeggio.

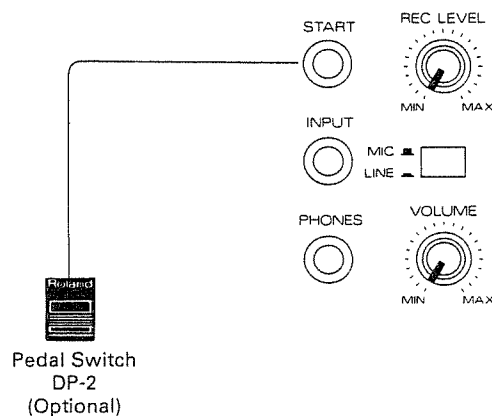

d. Trigger Play

By feeding external signal (audio or pulse) to the Input Jack ②, the note selected with the performance parameter will be played.

* See the picture on page 24.

Set the Input Level Switch ③ and the Recording Level Knob ⑤ to the positions which allow the most stable action.

- ▶ By connecting the optional Pedal Switch to the Start Jack ①, the Trigger playing can be performed with the pedal switch.

The Trigger Play function is available even during usual performance. However, when the Arpeggio is turned on, it will function differently as shown below.

Arpeggio Sync Mode	What is done by External Trigger
INT	The Arpeggio is performed in the set keys.
EXT	The Arpeggio played on the Keyboard will sync to the external trigger

Trigger Playing involves two performance parameters.

● Gate Time

TRG G-TIME = 0

When the external signal is very short (e.g. signal from a drum pad), the actual sounding time of the sound can be set with the Gate Time. Higher number is longer gate time.

When the external signal is very short (=the set gate time is short)

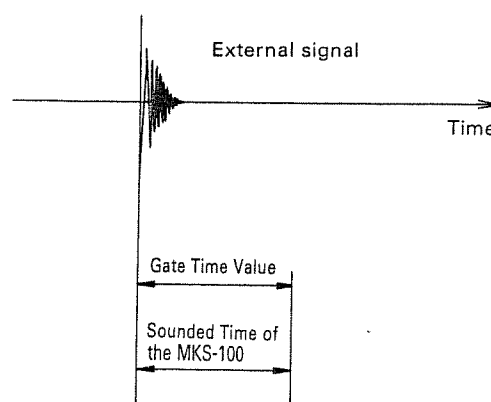

● Trigger Play

Ext Gate Play

Up to four notes to be trigger-played can be assigned. There are two ways for key registration.

Method 1 (Key registration with the Alpha Dial)

- ① Push the button ▶ ④.

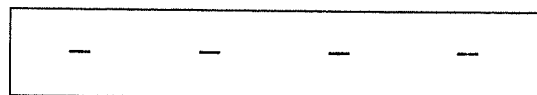

The Display will respond with:

It shows that up to four keys can be registered. "—" in the Display, shows that no key is registered. When a key is registered, the key number will be shown in the Display.

- ② Rotate the Alpha Dial until the desired key number is shown in the Display.



To register the next key, push the ► button to flash the next position, and select a key number by rotating the Alpha Dial. Likewise, the third and the fourth keys can be registered.

- ① When registration is completed, push the Enter Button.

Method 2 (Registration from the keyboard)

Connect the controller that features the Hold function (e.g. MIDI keyboard featuring Hold/Damper pedal).

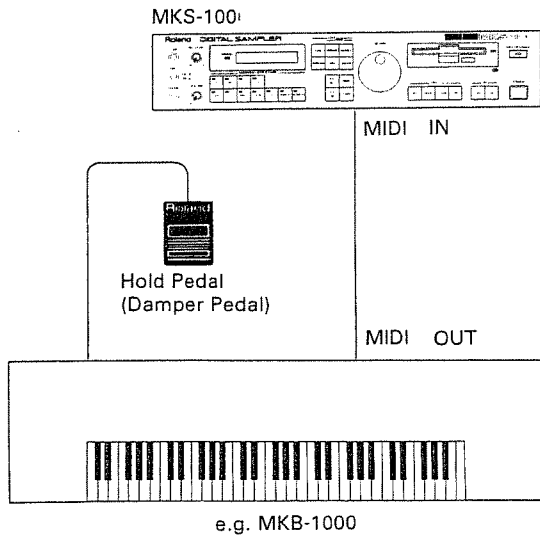

- ① Rotate the Alpha Dial until "Trigger Play" is shown in the Display.

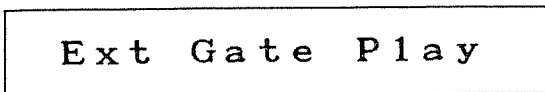

- ② Press the Hold Pedal.



- ③ While still pressing the Hold Pedal, push the keys (up to four keys) which you wish to register.

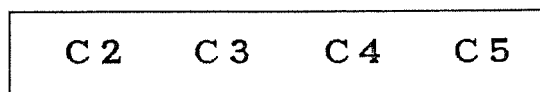

- ④ Release the Hold Pedal without releasing the keys.

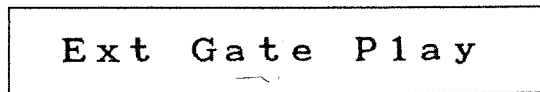

e. Detune

By playing one key, you can actually generate two sounds in slightly different pitches.

- ① Push the Structure Button **20** which contains the Bank you wish to use.

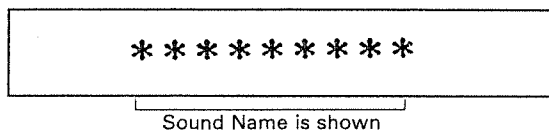

- ② Push the F1 button **21**.

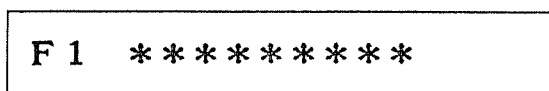

- ③ Push the same Structure Button you pushed in the step ①.

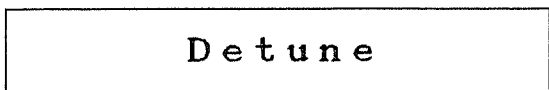

When using the Detune function, the MKS-100 is four voice polyphonic, When using the GR-Guitar System and the MIDI-Guitar converter in the MIDI Mono Mode, the 5th and the 6th Strings cannot be used.

To turn the Detune function off, simply push any of the Structure Buttons **20**.

The Detune function involves four performance parameters.

• Detune Range

In the Detune mode, the Detune Range value appears first by pushing the Performance Button **29**.



The pitch difference between the two sounds can be determined by the value of the Detune Range. Higher value increases the pitch difference.

• Detune Mode

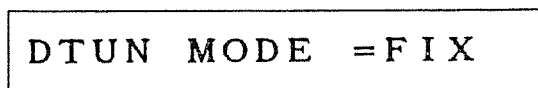

The pitch difference between the two sounds can be controlled by how you play the keyboard.

Mode	Display	Description
Fixed	FIX	The pitch difference of two sounds is not affected by how you play the keyboard
Touch Sensitivity	VELO	The harder playing manner will increase the pitch difference of two sounds

• Auto Bend Destination



When the auto bend effect is applied to a sound (with Wave Parameters explained on page 47), one of the detuned sounds can take on the auto bend effect.

Mode	Display	Description
Both	BOTH	Both voices take on Auto Bend.
Half	HALF	Either of voices takes on Auto Bend

- **Pitch Bend Destination**

BEND DEST = BOTH

One of the detuned sounds can take on the pitch bend effect.

Mode	Display	Description
Both	BOTH	Both voices take on Pitch Bend
Half	HALF	Either of voices takes on Pitch Bend

When the Pitch Bend of the Wave Parameter (explained on page 47) is OFF, sound would not take on the pitch bend effect.

If the MIDI Bender (explained on page 66) of the MIDI Functions is set to OFF, the MIDI pitch bend message is ignored, therefore, the pitch bend effect cannot be obtained.

f. Delay

When a key is played, the direct sound then delayed sound will be heard.

- ① Push the Structure Button ⑳ that contains the sound to take on the Delay effect.

- ② Push the F2 button ㉑.

F 2 *****

- ③ Push the same Structure Button that you pushed in the step ①.

Delay

When the Delay function is in use, the MKS-100 is four voice polyphonic. When using the GR-Guitar System and the MIDI-Guitar Converter in the MIDI Mono Mode, the 5th and 6th strings cannot be used.

To turn the Delay function off, simply push any of the Structure Buttons ㉒.

The Delay function involves three performance parameters.

- **Delay Time**

Delay time is the time spent between the direct and the delay sounds. In the Delay mode, the Delay time value will be first shown in the Display by pushing the Performance Button ㉓.

DELAY TIME = 1 2 7

- **Delay Sound Level**

DELAY LEVL = 1 2 7

The level of the delay sound can be set from 0 to 127.

- **Key Offset**

KEY OFFSET = 0

You can set the pitch of the delay sound higher or lower than the direct sound, in semi-tone steps from -12 (one octave lower) to +12 (one octave higher).

When the Split mode is selected with the Structure Button, the pitch of the delay sound may exceed that of the split. In such a case, the delayed sound is different from the voice of the played key.

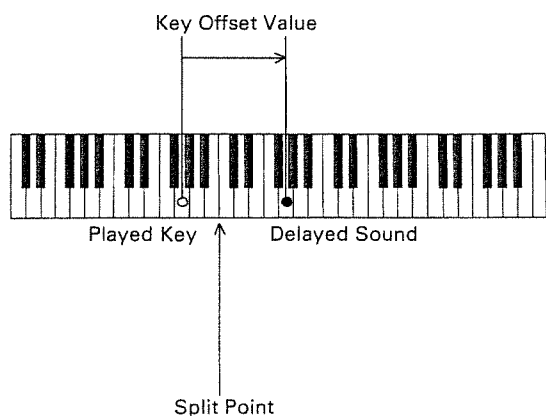

g. Dual Function

By playing only one key, the sounds in the two different Structures can be generated. Also, you can mute or generate a sound by playing the keyboard softer or harder.

1) Dual Tone

In the Dual Tone mode, the sounds of two different Structures can be simultaneously generated by playing only one key.

Push two Structure Buttons **20** at the same time.

Dual Tone

However, note that you cannot select the Structures which contain the same Banks, e.g., the Structures A and A/B, or A and AB/CD.

When the Dual Tone function is in use, the MKS-100 is four voice polyphonic. When using the GR-Guitar System and the MIDI-Guitar Converter in the MIDI Mono Mode, the 5th and 6th strings cannot be used.

To turn the Dual Tone function off, simply push any of the Structure Button **20**.

2) Velocity Mix

When two Structures are selected with Dual Tone function, one of the Structures (=Velocity Structure) can be muted under a set threshold level (minimum volume), while the other Structure (=Normal Structure) will always be heard no matter how softly you play the keyboard. That is, one of the sounds can be generated only if you play the keyboard stronger than the set threshold level, but it is muted if the volume is lower than the threshold level.

- ① Push the Structure Button **Ⓜ** to select the Normal Structure.

- ② Push the F1 button **Ⓜ**.

F1 *****

- ③ Push the Structure Button of the Velocity Structure.

V e l o - M i x

The indicator of the Normal Structure is lit, and that of the Velocity Structure flashes.

However, note that you cannot select the Structures which contain the same Banks, e.g., the Structures A and A/B, or A and AB/CD.

When the Velocity Mix function is in use, the MKS-100 is four voice polyphonic. When using the GR-Guitar System and the MIDI-Guitar Converter in the MIDI Mono Mode, the 5th and 6th strings cannot be used.

To turn the Velocity Mix function off, simply push any of the Structure Buttons **Ⓜ**.

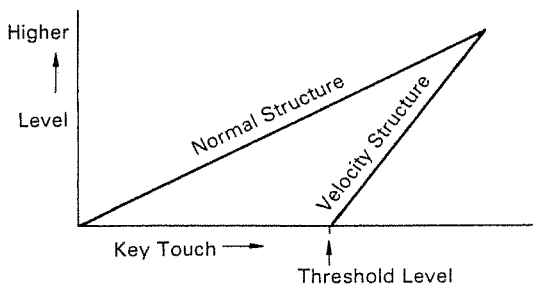

The Velocity Mix function involves only one performance parameter.

● **Velocity Mix Threshold**

This can set the threshold level (minimum volume) at which the Velocity Structure can sound.

V - M X T H R S H = 6 4

The value shown here represents the minimum strength of your key touch required for the Velocity Structure to sound. That is, when the value is higher, stronger playing manner is required, therefore, only by a very strong playing manner, you can hear both Structures.

3) Velocity Switch

This functions can select one of the two sounds to be generated depending on how you play the keyboard (Velocity). That is, you can hear one sound (=Weak Structure) when playing the keyboard softer than a set velocity, and the other sound (=Strong Structure) when playing harder than that.

- ① Push the Structure Button **Ⓜ** to select the Weak Structure.

- ② Push the F2 button **Ⓜ**.

F2 *****

- ③ Push the Structure Button to select the Strong Structure.

V e l o - S w i t c h

3. Performance Controlling Functions which are unrelated with Performance Parameters

The indicator of the Weak Structure is lit, and that of the Strong Structure flashes.

However, when the above function is in use, you cannot select the Structures which contain the same Banks, such as A and A/B, or A and AB/CD, etc.

* In this mode, the MKS-100 is eight voice polyphonic.

To turn the Velocity Switch function off, simply push any of the Structure Button .

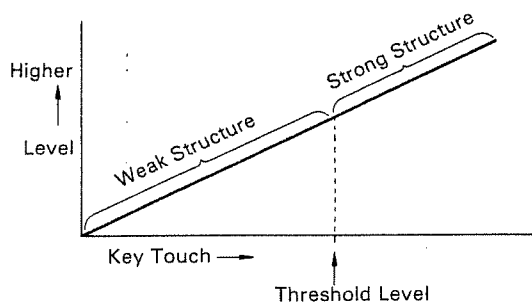

● Velocity Switching Threshold

This determines the threshold level (velocity) under which the Weak Structure is selected, and over which the Strong Structure is selected.

V-SW THRS = 64

By setting a high value (velocity), you can hear the Strong Structure only when playing the keyboard hard.

a. Pedal Hold

When the controller that features the Hold function (e.g. the MIDI keyboard featuring the Hold/Damper pedal), the Hold function can be turned on or off by pressing the pedal. Pedal Hold is the function that retains the sound even after the key is released.

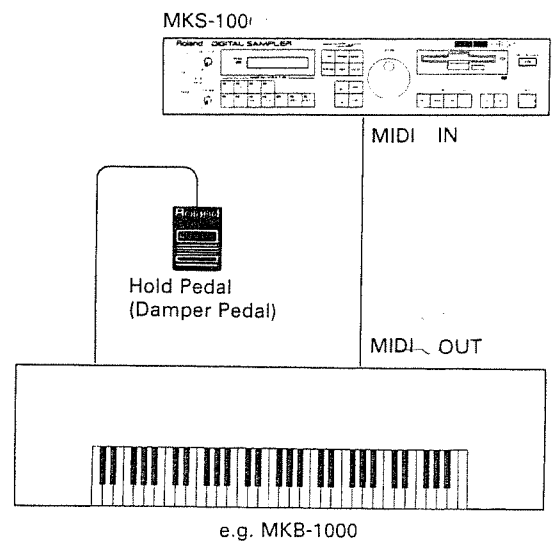

The sound which is not looped (explained on page 35) cannot take on the Hold effect.

b. Tuning

The MKS-100 can be tuned to other musical instrument within the range of semi-tone upper and lower.

- ① Push the Tune Button .



MST TUNE = 0

- ② Rotate the Alpha Dial until the MKS-100 is tuned to the other musical instrument.

MST TUNE = + 7 

The value shown in the Display represents how many cents are raised or lowered. (100 cents make a semi-tone)

- ③ Push the Enter Button .

To return to ± 0 cent, simply push the Enter Button  while holding the Tune Button  down.

c. Changing Split Point

When the Split Structure is currently in use, the split point can be changed. Also, in the Dual mode, the split point can be changed.

- ① See whether the indicator of the Structure is lit or flashing.

When lit:

Push the F1 button , and the Parameter Button.

When flashing:

Push the F2 button , then the Parameter Button.

SPLT : B3

The key number of the highest note in each Bank is shown in the Display.

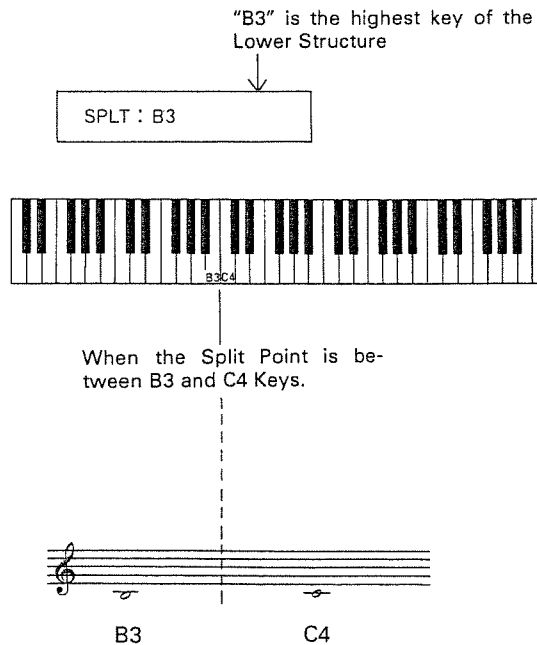

- ② Change the flashing key number using the Alpha Dial ⑩.

When the Structure A/B/C/D is in use, three split points will be shown. In this case, move the flashing positions using the buttons ► ⑪ and ◀ ⑫, then change the split points by rotating the Alpha Dial.

```
SPLT : B 2   B 3   B 4
```

- ③ When you have finished to change the split points, push the Enter Button ⑬.

When the Structure which is not splited is selected, but you have tried to change the split point, the Display will respond with as follows showing that it is not possible.

```
SPLT : No Split
```

4. Performance Parameters

Each side of a QD contains one Bank data with the information of performance parameters and split point. When the data is loaded from the QD to the MKS-100, the performance parameters of the data finally loaded will be kept in the MKS-100's memory. This means that you should be careful when loading data into the MKS-100 from different set of the QD's. If you wish to use only the voice and the split point information, you can leave out the performance parameter information as follows.

- **Loading the data into the MKS-100 without Performance Parameters**

Push the F2 Button ⑭, then the Load Button ⑮, and the data will be loaded leaving the performance parameter information.

When extracting a Bank or Banks of a Structure (page 18), the performance parameters are not loaded.

3 SAMPLING

Without using the performance disk, you can sample the voice from a microphone or audio equipment, and play it from the keyboard.

1. Basic Sampling

Plug a microphone or an instrument into the Input Jack ②

Move the Input Level Switch ③ depending on the output level of the mic or instrument connected.

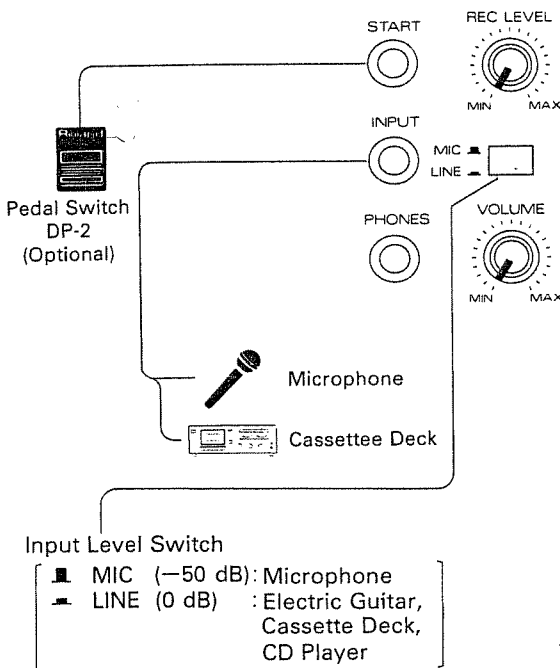

Example Settings of the Input Level Selector Switch

L (-50dB)	Microphone
M (-20dB)	Electric Guitar
H (0dB)	Cassette Deck, CD player (Line Level)

* When a microphone is connected, turn the Master Volume down, or it will cause howling.

① Select the Bank (A, B, C, or D) to be sampled.

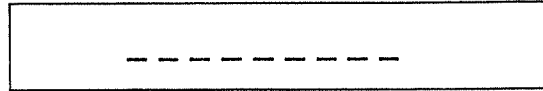

② Push the Recording Button ②⑤.



The selected Bank will be shown in the Display. Here, you can monitor the sampling sound with the amplifier, speakers or headphones connected to the Headphone Jack. If sampling from a mic, please do not use speakers.

③ Push the Stand-by Button ②⑦.

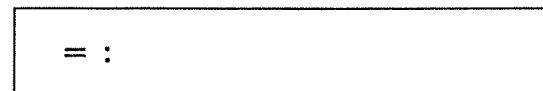

The Display now serves as a level meter. Ensuring that the sound is securely being fed into the sampler, adjust the Recording Level Knob at the far left of the panel. Just like the volume adjustment in tape recording, set the level as high as possible without exceeding the right margin in the Display.

④ Set the level of the Auto Trigger by rotating the Alpha Dial ①⑩ until the " : " mark in the Display reaches the desired position.

Auto Trigger is the function that starts the sampling automatically when the signal exceeding the set level is fed into the sampler.

When the signal that exceeds the trigger level (represented with " : " mark) is fed into the sampler, the far right of the Display shows " * " mark. Make sure that " * " does not appear in the Display because of noise.

Here, the MKS-100 is still in the stand-by mode.

- ⑤ Push the Start Button ⑭. (When a pedal switch is connected to the Start Jack 1, press the pedal.)

* REC KEY C4 *

Now, the Display shows the pitch of the sound to be sampled. When sampling a sound from a musical instrument, try to feed the correct pitch. (Even if a different pitch is used, it can be corrected later, though)

When the sound that exceeds the set Auto Trigger level is fed in, the sampling is done only for a second and the unit goes back to the Play mode in several seconds.

The performance parameters set before the sampling are retained in the MKS-100, therefore, it may not be necessarily played with the sampled sound. Reset all the performance parameters to the default settings by pushing the Enter Button ⑬ while holding the Performance Button ⑨ down.

You can now hear the sampled sound by external device. The sampled sound longer than 0.8 sec will be automatically looped (Autolooping). Looping function repeats playing a part of the sampled sound. This way, sustain sound can be performed. For instance, you can produce "Paaaaa...." sound by a sample "Pa".

Looping a sample can produce an annoying tricking or popping noise, but this can be removed later by correcting Wave Parameter (explained on page 41).

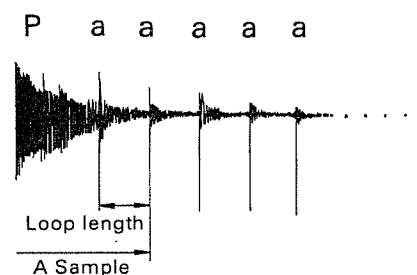

If the MKS-100's built-in computer cannot find the start point of the loop, the looping is not performed and the unit goes back to the Play mode.

If the Autoloop function of the Wave Modify parameters is set to Mode 3 or Mode 4, looping will be more difficult.

2. Changing Sampling Conditions

You can change the following sampling conditions: Key Numbers, Trigger Modes and Sampling Clock. Push the Recording Button **25** then the Mode Button **26**, and select the condition you wish to change by using the Forward Button **24** and Back Button **23**. Then make a necessary alteration with the Alpha Dial and push the Stand-by Button **27**, and you can move to the sampling operation.

- **Changing Key Numbers in Sampling**

REC KEY = C4

When you are sampling a specific pitch, you may wish to change key numbers. It is important to remember that the pitch higher than the originally sampled sound by more than 21 semi-tones is substituted with the pitch of lower octave.

- **Changing Trigger Modes**

REC TRIG= AUTO

Usually, set this to Auto Trigger mode. However, when sampling a slow attack sound that is difficult to start sampling, select Manual mode. The moment you push the Start Button **28** and the pedal switch connected to the Start Jack **1** (or push the Start Button twice), the sampling begins.

When the Manual mode is selected, the " : " mark in the Display goes out.

* The selected mode will remain even after the MKS-100 is turned off.

- **Sampling Clock**

SMP CLK = 30 kHz

Usually, one second sample can be recorded in a Bank at the 30kHz frequency. However, it can be extended to two seconds, by selecting the 15 kHz frequency. This, however, decreases high-frequencies, making the sound muffled.

3. Sampling a Long Tone or Split

To sample a long tone, you need the Structure AB (two seconds), CD (two seconds), or ABCD (four seconds). Also, when the tone delicately differs depending on the pitch, or two different sounds are required in the upper and lower sections of the splitted keyboard, you need the Structure A/B, C/D, AB/CD or A/B/C/D.



a. Sampling a Long Tone (Using Structure AB, CD or ABCD)

The necessary procedure is almost the same as the basic sampling.

After selecting a combined Structure such as AB, CD or ABCD, push the Recording Button , and the group of the relevant Banks is shown in the Display. Using the Sampling Clock function (on page 36) together with this effect of combining more than one Bank, the time can be even more extended twice as long.

In a single Bank sampling, the auto-looping is performed on the sample exceeding 0.8sec. But in a structure of combined Banks, auto-looping works when the last Bank exceeds 0.8sec. For instance, in the structure AB, the sample longer than 1.8 sec will be looped.

b. Sampling of Split Structure

When Split Structure such as A/B, C/D, AB/CD or A/B/C/D is selected, the group of the relevant Banks is shown in the Display by pushing the Recording Button . Select the desired group of the Banks to be sampled by rotating the Alpha Dial .

The necessary procedure is basically the same as the usual sampling. In this mode, however, next Bank to be sampled is displayed after you have sampled one Bank. When all Banks are sampled, the MKS-100 will automatically return to the Play mode.

If you wish to go back to the Play mode for verifying what you have sampled so far, push any of the Structure Buttons . When you resume sampling other Bank which has not been sampled yet, be sure to assign the correct Bank.

4. De-activating Looping

To sample a long tone, you use more than one Bank combined, and Looping is not necessary. The Looping function can be removed later or even now before any sampling is performed. To cancel the Looping function now, simply push any of the Structure Buttons while the Display is showing the following indication.

Seek loop point

4 Correcting the Sampled Data

The sampled sound is stored in the MKS-100's memory, and later when the keyboard is played, read from the memory and reconstructed. Wave Parameters are involved with the Reading and Reconstructing.

Even the useless samples will come to serve to your purpose if modified by the wave parameters to be played in a different way. For instance, the pitch of a sample can be modified during reading. Also, by using the wave parameters and changing the way of playing samples in more active ways, you can perform various things, e.g. changing looping, adding envelope curve, etc. In other words, wave parameters are not involved with transforming the sample itself, but only with changing how it is read from memory.

Each sampled sound has a set of wave parameters.

When more than one Bank is used for sampling a sound, the group of the Banks has a set of wave parameters.

The data loaded from a QD can also be modified with the wave parameters.

Single Bank Structure

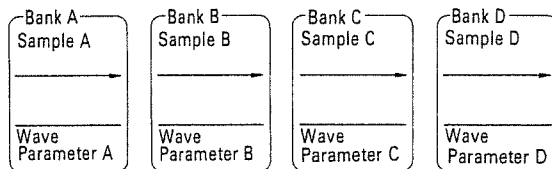

Structure AB

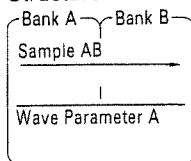

This concept applies to the Split Structure as well.

1. Editing Wave Parameters

Any of the wave parameters can be edited in the following method.

- ① Push the Parameter Button **⓫**.

EDT : A

The Display shows the Bank(s) which is to be edited by the wave parameters.

When a Split Structure is in use, select the Bank to be edited by using the **▶** button **⓬** and the **◀** button **⓭**.

- ② Select the wave parameter to be changed with the Forward Button **⓮** or Backward Button **⓯**.

REC KEY = C4

- ③ By rotating the Alpha Dial **⓰**, change the value of the parameter.

Repeat the steps ② and ③ as many times as necessary.

- ④ Push the Enter Button **⓱**.

Display	Wave Parameter
REC KEY	Recording Key Number
BANK TUNE	Bank Tune
LOOP TUNE	Loop Tune
SCAN MODE	Scanning Mode
LOOP TYPE	Loop Type
ST	Start Point
END	End Point (Manual)
LP	Loop Length (Manual)
AEN	End Point (Auto)
ALP	Loop Length (Auto)
KEY FOLLOW	Key Follow
PITCH BEND	Pitch Bend On/Off
VIBRATO	Vibrato On/Off
ENV V-SENS	Envelope Velocity Sensitivity
ENV RATE 1	Envelope Rate 1
ENV LEVEL 1	Envelope Level 1
ENV RATE 2	Envelope Rate 2
ENV LEVEL 2	Envelope Level 2
ENV RATE 3	Envelope Rate 3
ENV LEVEL 3	Envelope Level 3
ENV RATE 4	Envelope Rate 4
DYN SENSE	Dynamics Sensitivity
ABEND RATE	Auto Bend Rate
ABEND DPTH	Auto Bend Depth

Wave parameters can be edited while listening to the sound. However, the change of the sound may not be recognized. To monitor the edited sound, stop playing the MKS-100 once, then play it again.

When editing a parameter of a Split Structure, you can move to the parameter of other Bank by using the ►**②** or ◀**②** buttons.

Editing B

The Display will show the new Bank for a second, and now the wave parameters of that Bank can be edited.

2. Changing Looping

If you find the looping of the sample is strange or the pitch of a loop is incorrect, edit the sample with the wave parameters.

The picture will help you understand Looping

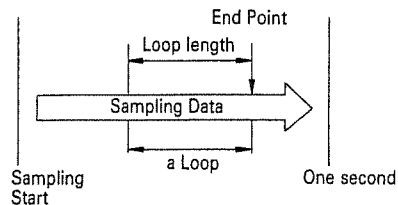

- **Loop Type**

LOOP TYPE = MAN

Select any of the loop types; One shot, Manual or Auto.

Mode	Display	Description
One Shot	1 SHOT	No looping
Manual	MAN	Looping is performed with the loop length and the End Point set at the corresponding Wave Parameters
Auto	AUTO	The ALP and AEN which are automatically detected decide the looping.

"Manual" allows you to edit the Loop Length and End Point. These two wave parameters are independent of each other, so, adjust them alternately while actually listening to the sound.

In the Manual mode, the default of the loop length and end point is the same as that of the Auto mode.

The loop length and the end point of the Manual and the Auto are preprogrammed separately, therefore, you can here recall the loop length and the end point of the Auto.

- **Loop Length**

LP = 4.01%

A loop is a section which replays while the key is being held down.

The length of the loop can be set with the "Loop Length". When the loop length is too short, the loop may get out of pitch. The pitch gap less than semi-tone can be later corrected by Loop Tune parameter (See page 42).

- **End Point**

END = 32767 100%

This is the end point of a loop.

* Even when 1 SHOT is selected, the End Point can be set; the sound later than the End Point is muted.

- **Loop Tune**

LOOP TUNE = 0

This can correct the pitch of a loop.

- **ALP**

ALP = ----- %*

In "Manual" mode, the loop length used in the "Auto" mode is shown just for guidance, but this cannot be altered.

- **AEN**

AEN = ----- %*

In the "Manual" mode, the end point used in the "Auto" mode is shown just for guidance, but this cannot be altered.

3. Tuning a Sample -

When you have sampled the pitch different from the key number shown in the Display, the pitch of the sampled sound can be tuned here.

Two wave parameters are involved, one is Sampling Key Number that does tuning in semi-tone steps, and the Bank Tune that does more delicate tuning.

- **Sampling Key Number**

REC KEY = C4

When you are sampling a specific pitch, change to the relevant key number. If not, release the key, play it again and while listening to the sound, tune to other instrument using the Alpha Dial α .

The pitch higher than the sampled pitch (Recording Key Number) by more than 21 semi-tones will be substituted with the lower octave.

- **Bank Tune**

BANK TUNE = 0

You can change the pitch in one cent step. The Display shows how many cents are raised or lowered from the pitch of the sample.

4. Scanning Mode

SCAN MODE = FWD

FWD, BWD and ALT determine how to read the samples:

- **FWD (Forward)**

This plays the samples in the sequence as they have been recorded. Usually, select this mode.

- **BWD (Backward)**

This plays the samples in the reverse sequence, just like the reverse playback of a tape recorder.

- **ALT (Alternate)**

This forwards and reverses a loop alternately. Changing the loop length, various effects can be obtained.

5. Start Point

ST = 0 . 00%

You can change the start point of the sample. The sample will be played from the set start point. This is useful for correcting the start point of the sample recorded in Manual.

Also, this can start the sample from the middle.

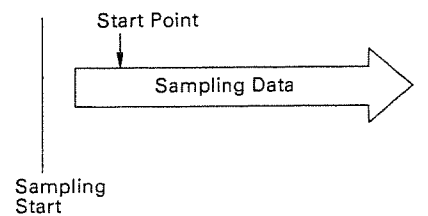

- **Address Display**

Address is the value that represents the time of Start Point, Loop Length and End Point. The length of a whole Bank is 32.767 address. A set of two Banks is 65.535 address. A set of four Banks is 131.071. The percentage that the address accounts for of the whole Bank is shown in the Display.

The value can be changed by rotating the Alpha Dial. Rotating the dial fast changes the value drastically.

6. Key Follow

KEY FOLLOW = ON

Usually Key Follow is ON, and playing each key on the keyboard will create the corresponding pitch.

Key Follow OFF is a rather special effect that generates only the same pitch as the sampled sound whatever note may be played. The pitch to be generated, moreover, can be altered by Recording Key Number and Bank Tune of the Wave Parameters.

7. Envelope

The MKS-100 offers you a wide range of control over the envelopes of the sampled sound.

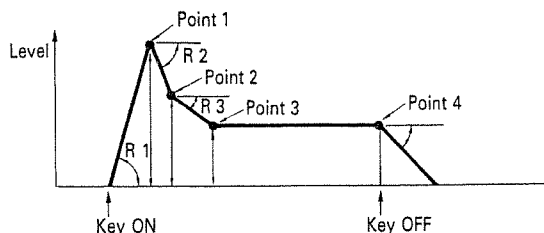

* R 1 and R 2 change depending on how you play the keyboard.

Wave Parameter "Rate" is a slope from a level (volume) to the next level. Higher Rate is a steeper slope. When the level difference between the first level and the next is small, the time needed for a slope is shorter.

Notes on Envelope Parameters

L1 and L2

When L1 is set to exactly the same length as L2, R2 has no meaning. Points 1 and 2 become one, and R1 is followed by R3 right away.

L2 and L3

When L3 is set to exactly the same length as L2, R3 has no meaning. Points 2 and 3 become one.

Envelope and Looping

When looped before the curve reaches Point 1, Point 1 slides to Point 3 in the slope of R3.

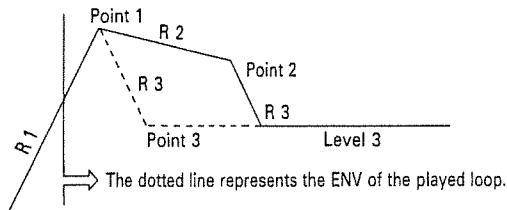

When looped while decaying in the slope of R2, the slope changes to R3 and slides to the Point 3.

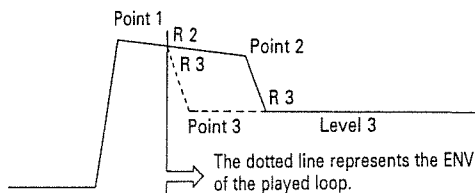

- **Envelope Rate 1 (R1)**

ENV RATE 1 = 127

The Envelope Rate 1 (the slope from Key-On to Point 1) can be set from 0 to 127. With the Wave Parameter "Envelope Velocity Sensitivity" set to high, the rate can be controlled by touch sensitivity on the keyboard.

- **Envelope Level 1 (L1)**

ENV LEVEL 1 = 127

The level of the Point 1 can be set from 0 to 127.

- **Envelope Rate 2 (R2)**

ENV RATE 2 = 127

The Envelope Rate 2 (the slope from Point 1 to Point 2) can be set from 0 to 127. With the Wave Parameter "Envelope Velocity Sensitivity" set to high, the rate can be controlled by touch sensitivity on the keyboard.

- **Envelope Level 2 (L2)**

ENV LEVEL 2 = 127

The level of the Point 2 can be set from 0 to 127.

- **Envelope Rate 3 (R3)**

ENV RATE3 = 127

The Envelope Rate 3 (the slope from Point 2 to Point 3) can be set from 0 to 127. (The actual slope of R3 is a curve.)

- **Envelope Level 3 (L3)**

ENV LEVEL3 = 127

The level of the Point 3 can be set from 0 to 127.

- **Envelope Rate 4 (R4)**

ENV RATE4 = 127

This is the slope that slides down from Key-Off to volume zero. 0 to 127 is valid for R4. Higher value is quicker decay. (The actual slope of R4 is a curve.)

- **Envelope Velocity Sensitivity**

ENV V-SENS = 0

With the Envelope Velocity Sens set to higher value, the R1 and R2 are controlled by the dynamics on the keyboard. That is, playing the keyboard harder will quicken the attack time, and vice versa. Even without setting the Envelope curve (ADSR), the attack time can be controlled with the touch sensitivity of the keyboard, by raising the value of the Envelope Velocity Sensitivity.

No matter how hard you play the keyboard, you cannot obtain the higher pitch than that of the sampled sound.

8. Dynamic Sense

DYN SENSE = 127

Dynamic Sense is the maximum effect of the touch sensitivity. The volume will change more drastically with the higher value.

9. Pitch Bender On/Off

PITCH BEND = ON

This selects whether the selected Bank will take the Pitch Bender effect. The Dual function (performance controlling functions) allows to mix the Bank with the pitch bender effect and the Bank without, creating a special effect.

When the MIDI Bender (explained on page 66) of the MIDI Functions is set to OFF, the MIDI Pitch Bend message is ignored, therefore, the pitch bend effect cannot be obtained.

10. Vibrato On/Off

VIBRATO = ON

This selects whether the selected Bank will take the vibrato effect (the Manual or Delay Vibrato) or not. The Dual function (performance controlling functions) allows to mix the Bank with the vibrato and the Bank without it, creating a special effect.

When the MIDI Modulation (explained on page 66) of the MIDI Functions is set to OFF, the MIDI Modulation message is ignored, therefore, the Manual Vibrato effect cannot be obtained.

11. Auto Bend

Auto Bend involves the depth and the rate of the pitch at the sound head.

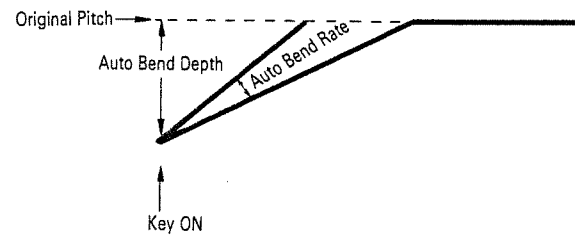

- Auto Bend Depth

ABEND DPTH = 0

This determines how much the pitch should be lowered from the sampled sound.

- Auto Bend Rate

ABEND RATE = 127

This determines the slope sliding to the original pitch.

12. Copying Wave Parameters

The following Wave Parameters can be copied individually or in bulk from a Bank to other Banks of a Split Structure. All what you need is to modify the copied parameters to desired forms. This would be much easier and quicker than making Wave Parameter from scratch.

Wave Parameters which can be copied are:

Loop Type
Scanning mode
Key Follow
Envelope
Envelope Velocity Sensitivity
Dynamic Range
Pitch Bender
Vibrato
Auto Bend Depth
Auto Bend Rate

a. Bulk Copy

After you have finished editing all the Wave Parameters in one Bank of the Split Structure, go to the following procedure.

While holding the Save Button **Ⓣ** down, push either **▶ ④** or **◀ ⑤**.

b. Individual Copy

- ① Select the Wave Parameter you wish to copy.
- ② While holding the Recording Button **Ⓡ** down, push either **▶ ④** or **◀ ⑤**.

13. Structure and Wave Parameters

When more than one Bank is combined for recording a sample, these Banks are considered to be one group, and one group has a set of wave parameters.

When the Structure AB is separated into A and B, each A and B requires and is given the set of parameters owned by the Structure AB. (The Loop Type is One Shot and the Start Point is 0.)

On the other hand when the two Structures A and B are converted to one Structure AB, it will have the set of parameters which used to belong to the Bank A. (The Loop Type is One Shot and the Start Point is 0.) The parameters which are owned by the Bank B will be lost, therefore, the pitch of the sampled sound is altered by the Bank A's Recording Key Number and Bank Tune. The Bank A and B will be played sequentially, but they will not be automatically set to the same pitch. In other words, unless they are recorded in the same pitch, the tuning after recording has no meaning.

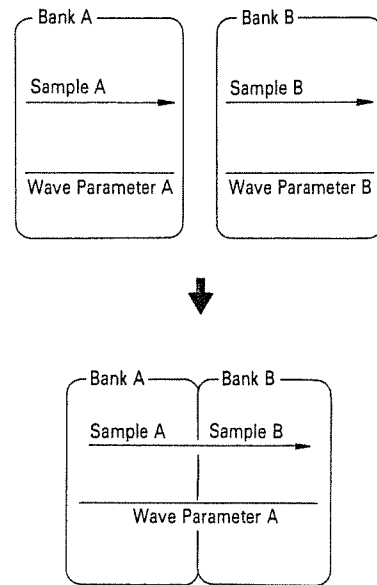
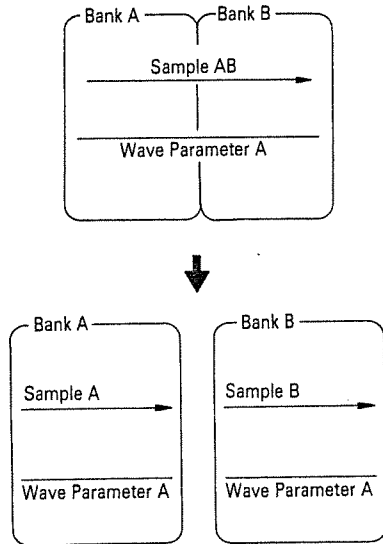

5 Saving

A whole Bank of the sampled sound can be saved on a quick disk(QD) with the Wave Parameters, Performance Parameters, Split Point, Structure Mode, Bank Name and File Name. The saved data can be loaded back to the MKS-100 at any time. This way, exactly the same situation before saving can be reproduced.

The data programmed on the MKS-100 can be used as the data for the Roland Digital Sampling Keyboard S-10.

1. Basic Saving

① Call the Bank to be saved and select the Structure Mode for playing it back.

② Push the Save Button ⑩.

Name : _ _ _ _ _

③ Write a File Name of the data as follows.

As you rotate the Alpha Dial, an alphabet, number or sign will appear at the flashing cursor in the Display. When the first letter is written, move the cursor to the next position using the ▶ Button ⑪, then write the second letter with the Alpha Dial.

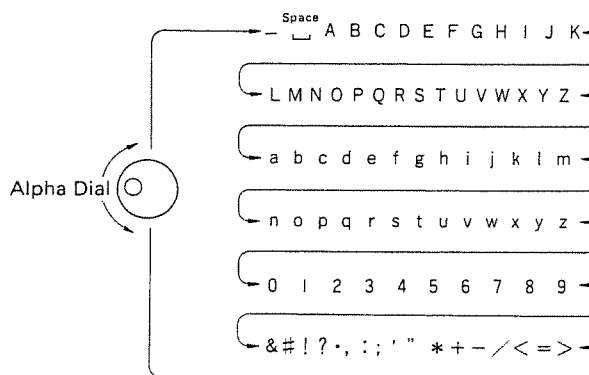

The cursor can be moved backward using the ◀ Button ⑫.

To make a space, simply push the Forward Button ⑬.

When you are editing the data loaded from a QD, the data is already named. Rename it if you like.

- ④ If you have completed to write the File Name, push the Save Button.

I n s e r t Q D

- ⑤ Insert the QD where the data is to be saved.

When a brand new QD is used, the data will be automatically saved onto it.

S a v e * * * * * * * * *

When any previous data is written on the QD, the Display will respond with:

K i l l * * * * * * * * * ?

If you wish to retain the data saved on the QD, make sure the disk drive indicator is dark, push the Eject Button and take the QD out, then insert the other QD.

Now, push the Save Button ⑩ .

To cancel saving, push any Structure Button ⑳ .

- ⑥ When the saving is completed, the Display will change to as below.

S a v e c o m p l e t e

To protect the saved data from an accidental loss, take the QD out, and snap off the Protect Nail.

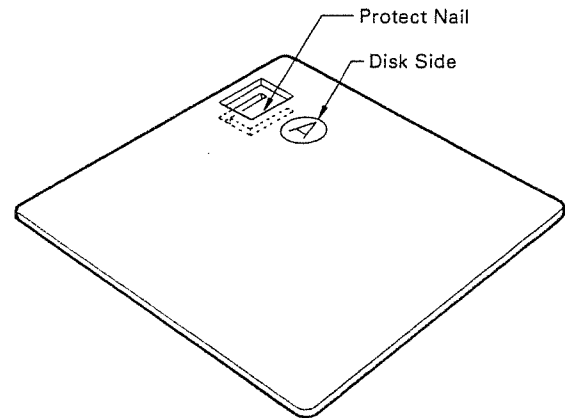

When more than one Bank is used in a Structure, the Display will respond with as shown below. This tells you that you need to save the other Bank to the other side of the QD.

C h a n g e Q D

As the Display indicates you, remove the QD and reinsert it with the other side facing upward. (or insert other QD)

Likewise, save all the Banks of the Structure.

When saving is impossible, the following error messages will be shown.

Error

Write protected

This tells you that the Protect Nail on the QD is snapped off.

To use such a QD again for saving, attach a selophane tape as shown below.

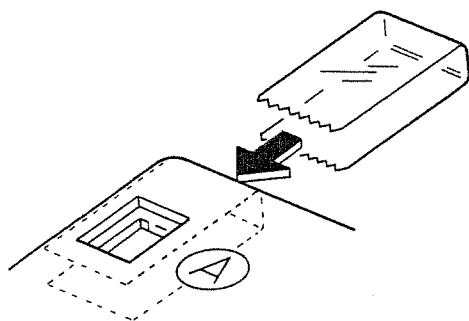

Verify Error

This tells you that the QD is damaged. Replace it with a proper one.

2. Quick Saving without Verification

This saving skips the verifying procedure whether the QD contains any previous data or not, therefore quicker. A brand new QD can be saved in this method.

Take exactly the same procedure as "1. Basic Saving", but push the F1 button before pushing the Save Button in step ②.

6 Wave Modification

Not only editing the Wave Parameters and Performance Parameters, the MKS-100 also allows to edit the sampled sound itself. We call this Wave Modification.

The Wave Modification actually processes the sample itself, therefore, the modified data cannot be restored. Please be sure to save the data onto a QD before performing Wave Modification.

First, select the factor to be wave-modified as follows.

- ① Select the Structure by using the appropriate Structure Button ④ .

Depending on the factor selected later in step ③, the Structures to be selected here is limited.

- ② Push the Modify Button ⑫ .

The Display shows "Wave Modify" for a moment. This indicates that it is now in the Wave Modify mode. While in the Wave Modify mode, no sound can be generated.

- ③ Using the Forward Button ⑭ and the Backward ⑮ Button , call the factor to be edited.

Now, go to the next procedure for actual Wave Modification.

► Wave Modification of individual Bank(s).

You can wave-modify an individual Bank or Banks of combined Structure as well as the whole Structure.

e.g. You can adjust the level of the Bank C of the Structure A/B/C/D, or apply "Digital Filter" to the Banks C D of the Structure AB/CD.

Push the Structure Button that corresponds to the Bank or Banks to be extracted from a combined Structure, then hit the Enter Button.

To return the extracted Bank (or Banks) to the original Structure, push the Structure Button of that Structure, then hit the Enter Button.

1. Level Adjusting

The volume of the sampled sound in each Bank can be adjusted.

Take the step ① on page 53 selecting any Structure you like.

Take the steps ② and ③, selecting "Level Adjust".

Lv 1 Adj Max = 100%

④ Set the desired level using the Alpha Dial.

* Here, if you push both the Button ► ④ and the Button ◀ ④ at a time, the maximum level of the sample is detected and shown in the Display. This will help you set the volume.

⑤ Push the Enter Button ⑤

Lv 1 ---->

The MKS-100 returns to the Playing mode.

When the level is set to 100%, each Bank will be automatically set to the maximum volume which is the level just before the sound is distorted. However, some samples are distorted every time they are played. This, however, does not mean that the Wave Data itself is distorted. So, simply set a lower value to remove the distortion.

When a Split Structure is selected, the volume of each Bank will become equal to the level set in the Level Adjusting.

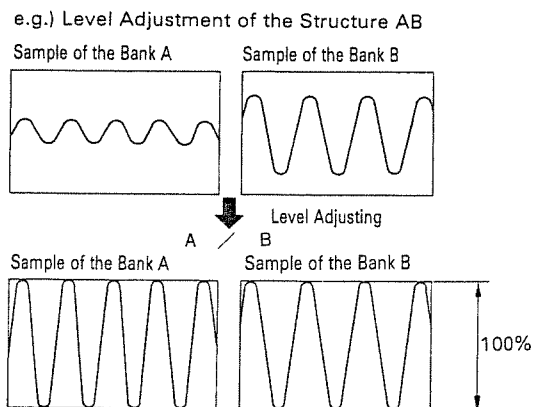

To adjust the level of a Bank or Banks of a Split Structure (e.g. AB of AB/CD), take the following procedure.

- 1) Simply call the relevant Bank(s) by pushing the appropriate Structure Button, then the Enter Button.
- 2) Adjust the level of a Bank or a group of Banks by taking step ② to ⑤.
- 3) Return the Bank or the group of Banks to the Structure it belongs to by pressing the Structure Button which was selected before you take the step 1), then push the Enter Button ⑤.

Error

S t r m i s s m a t c h

When this error message is indicated, the selected Structure is irrelevant, therefore, cannot be level-adjusted. Select the appropriate Structure by pushing the corresponding Structure Button then the Enter Button. Then repeat the whole procedure.

2. Reverse

Reverse function on the MKS-100 plays the sample backwards; similar to the tape recorder's reverse playback. If a Structure consists of more than a Bank, the group of Banks will be played as one, while each Bank will be individually played in the Split Structure.

Take the step ① on page 53, selecting any Structure you like.

Take the steps ② and ③, selecting "Reverse".

R e v e r s e

④ Push the Enter Button .

R v r s - - - - - >

When the sample is played up, the Display returns to the Playing mode indication.

A loop cannot be reversed; the looping is cancelled and One Shot is set automatically.

3. Auto Loop

Even when the looping is cancelled by otherWave Modification, the Auto Loop function can detect the optimum loop length and End point.

In a Structure of combined Banks, the group of Banks is looped as one, while each Bank of the Split Structure is looped individually.

Take the step ① on page 53, selecting any Structure you like.

Take the steps ② and ③, selecting "Auto Loop".

Loop Mode 1

④ By rotating the Alpha Dial, experiment and select one of the four Looping Modes.

⑤ Push the Enter Button .

Loop - - - - ->

When Auto Looping is finished, the Display changes to the Playing Mode indication.

By repeating the steps ④ and ⑤, select the Looping Mode you like.

After the Auto Looping is executed, the Wave Parameters ALP and AEN will retain the detected loop length and the ending point and the Loop Type remains AUTO.

Manual's LP and END are not affected by the Auto Loop procedure.

The looping mode set in the above step ④ will remain till later Auto looping that follows sampling.

Error

S t r m i s s m a t c h

When this error message is indicated, the selected Structure is irrelevant, therefore, cannot be auto-looped. Select the appropriate Structure by pushing the corresponding Structure Button then the Enter button. Then repeat the whole procedure.

4. Copy

The sampled sound and the Wave Parameters stored in a Bank (or Structure) can be copied into a different Bank (or Structure).

The destination Bank(s) is limited depending on the type of the source Bank(s) that you wish to copy as shown below.

Source Bank(s)	Destination Bank(s)
A	→ B、C、D
B	→ A、C、D
C	→ A、B、D
D	→ A、B、C
AB	→ CD
CD	→ AB
A/B	→ C/D
C/D	→ A/B

Take the step ① on page 53, assigning the source Bank (Structure), and go to the steps ② and ③, selecting "Copy".

C o p y = > B

The destination Bank (Structure) is shown in the Display. When the source Bank is A, B, C or D, you can select the destination Bank with the Alpha Dial ④.

④ Push the Enter Button ⑤.

C o p y - - - - - >

When the copying is done, the above indication disappears.

Error

When you have assigned the destination Bank (Structure) where the source Bank (Structure) cannot be copied, the following error indication is shown in the Display.

C o p y s t r e r r o r

Repeat the copying procedure with a proper Bank (Structure) selected.

5. Swap

The contents (sampled sound and Wave Parameters) of two different Banks (Structures) can be swapped. The destination Bank (Structure) is limited depending on the source Bank (Structure) that you wish to swap as shown on page 57.

Take the step ① on page 53, selecting one of the two Banks (Structures) to be swapped.

Take the steps ② and ③, selecting "Swap".

Swap <=> B

Now, the data is swapped between the Bank (Structure) shown in the Display and the one whose structure indicator is lit. When you wish to change the Structure shown in the Display, use the Alpha Dial.

④ Push the Enter Button **⏎**.

Swap - - - - ->

When the swapping is completed, the Display will return to the Playing mode indication.

To swap a single Bank of a Structure (such as A of A/B) with other single Bank of other Structure (such as C of C/D), it is necessary to extract the Bank from the Structure beforehand.

Select a Bank to be swapped from a Structure by pushing the relevant structure Button and push the Enter Button **⏎**, then select a Bank to be swapped from another Structure and push the Enter Button.

Now, take the usual swapping procedure.

When swapping is completed, push the same Structure Button which was selected before selecting the Structure to be swapped, then push the Enter Button **⏎** to return to the previous condition.

Error

The following error indication shows that you have chosen the Structures which cannot be swapped.

Swap str error

Str mismatch

Select the appropriate Structure by pushing the corresponding Structure Button then the Enter button. Then repeat the whole procedure.

(Take the above procedure for both Structures.)

6. Digital Filter

The Digital Filter can be used to reduce the sampling noise or to change the timbre or the sampled voice.

There are four different filters optional.

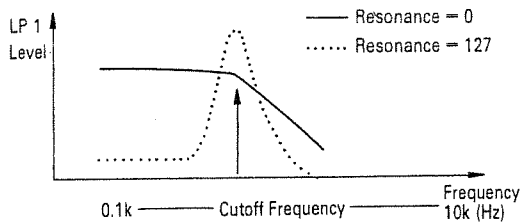

Lowpass Filter with relatively mild cutoff frequency.

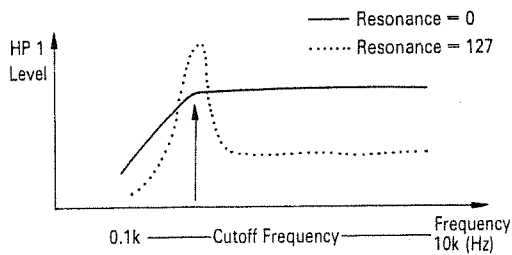

Highpass Filter with relatively mild cutoff frequency.

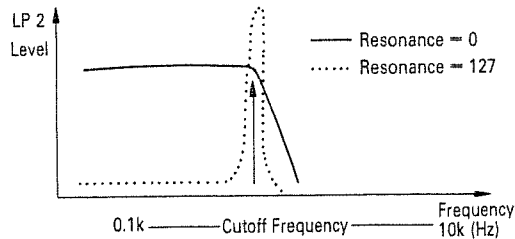

Lowpass Filter with sharp cutoff frequency

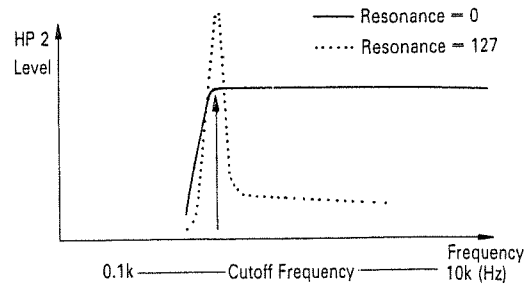

Highpass Filter with sharp cutoff frequency

Resonance: This emphasizes the harmonic contents at the set cutoff frequency, creating electric and metallic sound.

The digital filtering is processing with computer, therefore, cannot be performed while the keyboard is being played.

The filtered sample cannot be restored again. Please be sure to make a backup QD before filtering the sample.

To use two filters at a time, take the following procedure twice.

Take the step ① on page 53, selecting any Structure you like.

Take the steps ② and ③, selecting one of the four filters.

LP1 F= 10k R=000

HP1 F=0.1k R=000

LP2 F= 10k R=000

HP2 F=0.1k R=000

④ Set the Cutoff Frequency and the Resonance.

Using the Alpha Dial ⑭, set the value at the flashing cursor, and move the position of the cursor with the ► and ◀ Buttons.

⑤ Push the Enter Button ⑮.

LPF2 ----->

When the memory is rewritten with the filtered data, the Display returns to the Playing mode indication.

Error

Str mismatch

When this error message is indicated, the selected Structure is irrelevant, therefore, cannot be digital-filtered. Select the appropriate Structure by pushing the corresponding Structure Button then the Enter button. Then repeat the whole procedure.

7. Mixing

The voices of two different Banks (Structures) can be mixed. However, the pitch difference between two voices cannot be corrected. The two sounds to be mixed should be recorded in the same pitch.

The Structures to be mixed should be the same type. (For instance, the Structures A and CD cannot be mixed)

The mixed data can be written into the source Structure or the same type Structure. The voices to be mixed should be 30 kHz sampling. 15 kHz sampling cannot be properly mixed.

Take the step ① on page 53, selecting either of the Structures to be mixed.

Take the steps ② and ③, selecting "Mix".

M i x B => C

The Structure shown in the left of the Display and the one whose Structure Button is lit are mixed and rewritten into the Structure shown at the right of the Display.

The destination Structure (shown at the right of the Display) can be selected by moving the flashing cursor with the ► button ④ and using the Alpha Dial ⑤.

When the Structure A, B, C or D is selected (the indicator on), the Structure (shown at the left of the Display) which is to be mixed with the selected structure can be altered.

④ Push the Enter Button ⑥.

M i x - - - - ->

When the mixed data is written, the Display returns to the Playing mode indication.

Now, the Wave Parameters are reset as shown below. You may need to edit the Wave Parameters here.

Reset Values of Wave Parameters after Mixing

REC KEY	Recording Key Number	Indefinite
BANK TUNE	Bank Tune	0
LOOP TUNE	Loop Tune	0
SCAN MODE	Scanning Mode	FWD
LOOP TYPE	Loop Type	1 SHOT
ST	Start Point	0 0.0%
END	End Point (Manual) 100%
LP	Loop Length (Manual)	4 %
AEN	End Point (Auto) 100%
ALP	Loop Length (Auto)	4 %
KEY FOLLOW	Key Follow	ON
PITCH BEND	Pitch Bend On/Off	ON
VIBRATO	Vibrato On/Off	ON
ENV V-SENS	Envelope Velocity Sensitivity	0
ENV RATE 1	Envelope Rate 1	127
ENV LEVEL 1	Envelope Level 1	127
ENV RATE 2	Envelope Rate 2	127
ENV LEVEL 2	Envelope Level 2	127
ENV RATE 3	Envelope Rate 3	127
ENV LEVEL 3	Envelope Level 3	127
ENV RATE 4	Envelope Rate 4	127
DYN SENSE	Dynamics Sensitivity	127
ABEND RATE	Auto Bend Rate	127
ABEND DPTH	Auto Bend Depth	0

The mixing balance of the the two voices cannot be set here; it is determined by the volume of the voices before mixed. So, please take the Level Adjusting procedure before mixing.

Error

The following error indication shows that the selected Structure is not appropriate.

Mix str error

Str mismatch

Select the appropriate Structure by pushing the corresponding Structure Button then the Enter Button. Then repeat the whole procedure.
(Take the above procedure for both Structures.)

8. Combine

a. Combining two independent Banks

Combining Function is joining two voices (Banks) with the unnecessary portions discarded.

When two voices stored in the two independent Banks (such as the Structure A, B, C, D, A/B, C/D, or A/B/C/D) are combined in the two Bank Structure (such as AB, CD, or AB/CD), the End Point of the first sample is directly joined to the Start Point of the second sample.

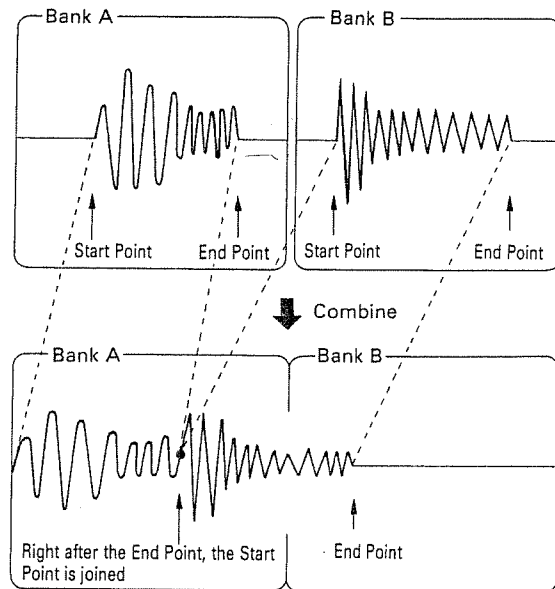

The two voices should be in the same sampling pitch.

The Structures which can be combined are:

- A → B
- C → D
- AB → CD

* The voice in each Bank should be the same sampling clock.

- ① Assign the Structure A or C. To combine the Structures AB and CD, assign AB.
- ② Push the Modify Button ⑫.
- ③ Using the Forward Button ⑳ and the Backward Button ㉑, select "Combine".

C o m b i n e *

- ④ Using the Alpha Dial ㉒, select the Structure to be combined with the one whose Structure Button is lit.

The Display shows the Structure you have selected.

C o m b i n e B

- ⑤ Push the Enter Button ㉓.

C m b n ----->

The combined data is stored in the Structure whose indicator is lit.

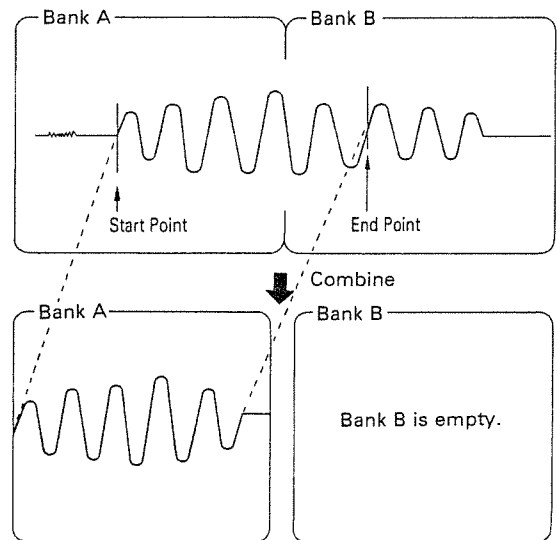

b. Cutting unnecessary portions (of Structure AB, CD or ABCD)

Using the Combining function, you can cut the unnecessary portions: before the Start Point of the first Bank and after the End Point of the second Bank.



The portions to be used after combined is between the Start Point and the End Point set with the corresponding Wave Parameters.

That is, the combined data may be short enough to be rewritten in one Bank(A). This way, one of the two Banks can be emptied ready to be used for new sampling.

- ① Select the Structure AB, CD or ABCD.
- ② Push the Modify Button .
- ③ Using the Forward Button  and the Backward Button , select "Combine".

C o m b i n e *

- ④ Push the Enter Button . (Do not touch the Alpha Dial.)

C m b n - - - - >

When the Combining is completed, the Display returns to the Playing mode indication.

Error

The following error indication shows that the Structure you have selected is not appropriate.

C o m b i n e s t r e r r

S t r m i s s m a t c h

Select the appropriate Structure by pushing the corresponding Structure Button then the Enter Button. Then repeat the whole procedure. (Take the above procedure for both Structures.)

Error

The following error indication shows that the combined data will after all be exactly the same as the original voice. Please check the Start Point and the End Point of the Wave Parameters.

N o n e e d t o C o m b n

7 MIDI

The MKS-100 features the following three MIDI Connectors.

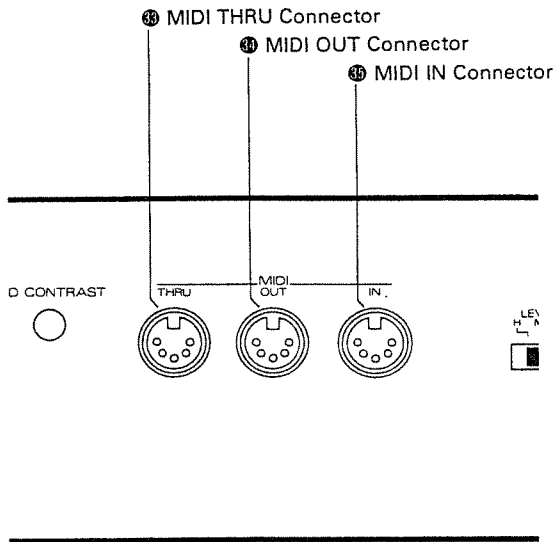

- **MIDI IN Connector 40**

Connect the MIDI IN connector of the MKS-100 to the MIDI OUT of the external device (e.g. MIDI keyboard, MIDI sequencer). The MKS-100's sound will be played by the external device.

- **MIDI OUT Connector 39**

Through this connector, the message such as Structure selecting is transmitted.

- * The MIDI OUT does not transmit the signal fed into the MIDI IN.

- **MIDI THRU Connector 38**

The exact copy of the signal fed into the MIDI IN is sent out through this connector. Using MIDI THRU connectors, one MIDI device can control more than several MIDI devices.

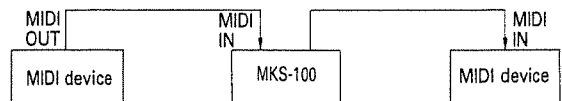

NOTE

The MIDI THRU connectors technically allow to connect as many MIDI devices, but in practice, we recommend to use the optional MIDI THRU Box MM-4 or MIDI Output Selector MPU-105 for the connection of more than three units.

1. Changing MIDI Functions

The setting of each MIDI Function can be changed as follows.

① Push the MIDI Button **11**.

② Select the MIDI Function you wish to change using the Forward Button **21** and the Backward Button **29**.

③ By rotating the Alpha Dial **14**, change the setting of the MIDI Function as desired.

Repeat the steps ② and ③ as many times.

④ Push the Enter Key **18**.

● MIDI Channel

MIDI CHANNEL = 1

Select any of the MIDI Channels 1 to 16.

● Bender

MIDI BENDER = ON

ON: Receive
OFF: Ignore

● Hold

MIDI HOLD = ON

ON: Receive
OFF: Ignore

● Modulation

MIDI MOD = ON

ON: Receive
OFF: Ignore

● Program Change

PGM CHANGE = OFF

ON: Receive and Transmit
OFF: Ignore

- **Registered Parameters**

(Bend Range and Master Tune messages)

REG-PARAM = OFF

ON: Receive and Transmit
OFF: Ignore

- **Exclusive**

EXCLUSIVE = OFF

ON: Receive and Transmit
OFF: Ignore

- **MIDI Mode**

MIDI MODE = POLY

This function selects MIDI Poly mode or the MIDI Mono mode.

When the Mono mode command is transmitted from the external MIDI device, the MKS-100 will be automatically set to Mono mode. (The Mono Mode Indicator lights up.) Meanwhile, the Display shows the number of the voices (8 or 4 voices) which can be simultaneously sounded.

MIDI MODE = MONO8

The voice of the MKS-100 is fixed to 8 voice polyphonic (or 4 voice when the Dual Function is in use). It cannot be changed by operating the MKS-100.

- **Control Channel**

When the MKS-100 is set to the Mono mode, this selects the MIDI channel on which the Control message common for all the voices are received. As a Control Channel, you can use either the basic channel (the channel number you set in the MIDI Channel of the MIDI Function) or the global channel (the channel one number lower than the basic channel). Usually, the basic channel should be selected.

- **Key Range**

This can set the highest and the lowest key number which can be received by the MKS-100.

Assign the highest key number to be received.

Assign the lowest key number to be received.

You can reset all the MIDI Functions to the default settings (Shown on page 66 and 67).



Simply push the Enter Button **⏏** while holding the MIDI Button **⏏** down.

2. Program Change

The MKS-100 can receive or transmit the following message using the Program Change; the Structure Selection, ON/OFF of the Detune, Delay and Dual Functions.

The table shown right represents the Program Change number assigned to each message.

The Program Change assignment can be seen on the MIKS-100 as follows.

- ① Push the F2 Button , then the MIDI Button .
- ② Rotate the Alpha Dial , and the Program Change number and the corresponding message is shown in the Display.

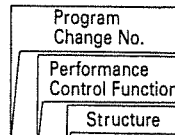

# 1	A	
# 2	B	
# 3	C	
# 4	D	
# 5	AB	
# 6	CD	
# 7	ABCD	
# 8	A/B	
# 9	C/D	
# 10	AB/CD	
# 11	A/B/C/D	
# 12	DT A	DT: Detune Function
# 13	DT B	
# 14	DT C	
# 15	DT D	
# 16	DT AB	
# 17	DT CD	
# 18	DT ABCD	
# 19	DT A/B	
# 20	DT C/D	
# 21	DT AB/CD	
# 22	DT A/B/C/D	
# 23	DL A	DL: Delay Function
# 24	DL B	
# 25	DL C	
# 26	DL D	
# 27	DL AB	
# 28	DL CD	
# 29	DL ABCD	
# 30	DL A/B	
# 31	DL C/D	
# 32	DL AB/CD	
# 33	DL A/B/C/D	
# 34	Du A B	Du: Dual Function
# 35	Du A C	
# 36	Du A D	
# 37	Du A CD	
# 38	Du A C/D	
# 39	Du B C	
# 40	Du B D	
# 41	Du B CD	
# 42	Du B C/D	
# 43	Du C D	
# 44	Du C AB	
# 45	Du C A/B	
# 46	Du D AB	
# 47	Du D A/B	
# 48	Du AB CD	
# 49	Du AB C/D	
# 50	Du CD A/B	
# 51	Du A/B C/D	
# 52	VM A B	VM: Velocity Mix Function
# 53	VM A C	
# 54	VM A D	
# 55	VM A CD	
# 56	VM A C/D	
# 57	VM B A	
# 58	VM B C	
# 59	VM B D	
# 60	VM B CD	
# 61	VM B C/D	
# 62	VM C A	

The structure at the left side always sounds and the one at the right side sounds only with the stronger playing manner.

63 VM C B
 # 64 VM C D
 # 65 VM C AB
 # 66 VM C A/B
 # 67 VM D A
 # 68 VM D B
 # 69 VM D C
 # 70 VM D AB
 # 71 VM D A/B
 # 72 VM AB C
 # 73 VM AB D
 # 74 VM AB CD
 # 75 VM AB C/D
 # 76 VM CD A
 # 77 VM CD B
 # 78 VM CD AB
 # 79 VM CD A/B
 # 80 VM A/B C
 # 81 VM A/B D
 # 82 VM A/B CD
 # 83 VM A/B C/D
 # 84 VM C/D A
 # 85 VM C/D B
 # 86 VM C/D AB
 # 87 VM C/D A/B

88 VS A B VS: Velocity Switch Function

89 VS A C
 # 90 VS A D
 # 91 VS A CD

[The structure at the left side sounds with the softer playing manner and the one at the right side sounds with the stronger playing manner.]

92 VS A C/D
 # 93 VS B A
 # 94 VS B C
 # 95 VS B D
 # 96 VS B CD
 # 97 VS B C/D
 # 98 VS C A
 # 99 VS C B
 # 100 VS C D
 # 101 VS C AB
 # 102 VS C A/B
 # 103 VS D A
 # 104 VS D B
 # 105 VS D C
 # 106 VS D AB
 # 107 VS D A/B
 # 108 VS AB C
 # 109 VS AB D
 # 110 VS AB CD
 # 111 VS AB C/D
 # 112 VS CD A
 # 113 VS CD B
 # 114 VS CD AB
 # 115 VS CD A/B
 # 116 VS A/B C
 # 117 VS A/B D
 # 118 VS A/B CD
 # 119 VS A/B C/D
 # 120 VS C/D A
 # 121 VS C/D B
 # 122 VS C/D AB
 # 123 VS C/D A/B

124 A
 # 125 B
 # 126 C
 # 127 D
 # 128 AB

Receive Only

8 ERROR MESSAGES

Error Messages shown during loading

Wrong QD

The connected QD is irrelevant with the data to be loaded.

Replace the QD with the relevant one.

Illegal QD

The connected QD contains no data.

I/O Error 1

The MKS-100 has broken down. Call for the Roland service station.

I/O Error 2

The QD is damaged.

Replace it with a new one and repeat loading procedure.

I/O Error 3

The MKS-100 has broken down. Call for the Roland service, station.

I/O Error 4

The MKS-100 has broken down. Call for the Roland service station.

Error Messages shown during saving

Write protected

The Protect Nail is snapped off.

Verify Error

The connected QD is damaged. Replace it with the other QD.

Error Messages shown during Wave Modification

Combine str err

The Structure you have selected cannot be combined. Select an appropriate Structure by pushing the Corresponding Structure Button then the Enter Button.

If two Structures are relevant for Combining, take the above procedure for both Structure.

Mix str error

The Structure you have selected cannot be mixed. Select an appropriate Structure by pushing the Corresponding Structure Button then the Enter Button.

Take the above procedure for both Structures.

Copy str error

The Structure you have selected cannot be copied. Select an appropriate Structure by pushing the Corresponding Structure Button then the Enter Button.

Swap str error

The Structure you have selected cannot be swapped. Select an appropriate Structure by pushing the Corresponding Structure Button then the Enter Button.

Take the above procedure for both Structures.

No need to Comb

The combined data would become exactly the same as the original voice.

Check the values of the Start point and the End point of the Wave Parameter.

Warn Empty bank

There is no data in the selected Bank.

Str mismatch

When this error message is indicated, the selected Structure is irrelevant, therefore, cannot be wave modified. Select the appropriate Structure by pushing the corresponding Structure Button then the Enter button. Then repeat the whole procedure. (If two Structures are relevant, take the above procedure for both Structures.)

DISK MEMO

Disk No.	A B	Name	
Structure	[Split Point:]		

Performance Parameter		Wave Parameter	
VIB RATE		REC KEY	
M - VIB DPTH		BANK TUNE	
D - VIB DPTH		LOOP TUNE	
D - VIB DLAY		SCAN MODE	
BEND MODE		LOOP TYPE	
ARP SYNC		ST	
ARP RATE		END	
ARP MODE		LP	
ARP RANGE		AEN	
ARP REPERT		ALP	
ARP DECAY		KEY FOLLOW	
V - MX THRSH		PITCH BEND	
V - SW THRSH		VIBRATO	
DTUN MODE		ENV V - SENS	
DTUN RANGE		ENV RATE 1	
ABEND DEST		ENV LEVEL 1	
BEND DEST		ENV RATE 2	
DELAY TIME		ENV LEVEL 2	
DELAY LEVL		ENV RATE 3	
KEY OFFSET		ENV LEVEL 3	
TRG G - TIME		ENV RATE 4	
Ext Gate Play		DYN SENSE	
		ABEND RATE	
		ABEND DPTH	

Disk No.	A B	Name	
Structure	[Split Point:]		

Performance Parameter		Wave Parameter	
VIB RATE		REC KEY	
M - VIB DPTH		BANK TUNE	
D - VIB DPTH		LOOP TUNE	
D - VIB DLAY		SCAN MODE	
BEND MODE		LOOP TYPE	
ARP SYNC		ST	
ARP RATE		END	
ARP MODE		LP	
ARP RANGE		AEN	
ARP REPERT		ALP	
ARP DECAY		KEY FOLLOW	
V - MX THRSH		PITCH BEND	
V - SW THRSH		VIBRATO	
DTUN MODE		ENV V - SENS	
DTUN RANGE		ENV RATE 1	
ABEND DEST		ENV LEVEL 1	
BEND DEST		ENV RATE 2	
DELAY TIME		ENV LEVEL 2	
DELAY LEVL		ENV RATE 3	
KEY OFFSET		ENV LEVEL 3	
TRG G - TIME		ENV RATE 4	
Ext Gate Play		DYN SENSE	
		ABEND RATE	
		ABEND DPTH	

8-voice digital sampling module

MODEL MKS-100 MIDI Implementation

1. TRANSMITTED DATA

Status	Second	Third	Description	
1011 nnnn	0000 0110	0vvv vvvv	Data Entry MSB	*1-1,2
1011 nnnn	0010 0110	0vvv vvvv	Data Entry LSB	*1-1,2
1011 nnnn	0110 0100	0vvv vvvv	RPC LSB	*1-1,2
1011 nnnn	0110 0101	0vvv vvvv	RPC MSB	*1-1,2
			RPC # = 0, 1	
1100 nnnn	0ppp pppp		Program Change	*1-1,3
			ppppppp = 0 - 122	
1111 0000	1111 0111	System exclusive	*1-1,4

Notes :

*1-1 Transmitted if the corresponding function switch is ON.

*1-2 When BEND RANGE or MASTER TUNE is changed, RPC (Registered parameter control number) and its value are sent as follows.

BnH, 64H, pp, 65H, qq, 06H, mm, 26H, ll
 pp,qq = RPC number LSB,MSB
 mm,ll = parameter value MSB,LSB

RPC #	value MSB	value LSB	Description
0	0vvv vvvv	0000 0000	(Pitch bend sensitivity) BEND RANGE 0-12 semitone, 1 semitone step
1	0vvv vvvv	0vvv vvvv	(Master fine tuning) MASTER TUNE -99 - +99 cent, 1 cent step

*1-3 Program change number indicates the condition of the 'Sampling Structure'. (See Owner's manual)

*1-4 See section 3 (EXCLUSIVE COMMUNICATION).

2. RECOGNIZED RECEIVER DATA

Status	Second	Third	Description	
1000 nnnn	0kkk kkkk	0vvv vvvv	Note OFF, velocity ignored	
1001 nnnn	0kkk kkkk	0000 0000	Note OFF	
			kkkkkkk = 24 - 103	*2-1
1001 nnnn	0kkk kkkk	0vvv vvvv	Note ON	
			kkkkkkk = 24 - 103	*2-1
			vvvvvvv = 1 - 127	
1011 nnnn	0000 0001	0vvv vvvv	Modulation depth	*2-2,3
1011 nnnn	0000 0110	0vvv vvvv	Data Entry MSB	*2-2,4
1011 nnnn	0010 0110	0vvv vvvv	Data Entry LSB	*2-2,4
1011 nnnn	0100 0000	0vvv vvvv	Hold OFF	*2-2
			vvvvvvv = 0 - 63	
1011 nnnn	0100 0000	0vvv vvvv	Hold ON	*2-2
			vvvvvvv = 64 - 127	
1011 nnnn	0110 0100	0vvv vvvv	RPC LSB	*2-2,4
1011 nnnn	0110 0101	0vvv vvvv	RPC MSB	*2-2,4
1100 nnnn	0ppp pppp		Program Change	*2-2,5
			ppppppp = 0 - 127	
1110 nnnn	0vvv vvvv	0vvv vvvv	Pitch Bend Change	*2-2
1011 nnnn	0111 1011	0000 0000	ALL NOTES OFF	*2-6,7
1011 nnnn	0111 1100	0000 0000	OMNI OFF	*2-6
1011 nnnn	0111 1101	0000 0000	OMNI ON	*2-6
1011 nnnn	0111 1110	000m mmmm	MONO ON	*2-6
1011 nnnn	0111 1111	0000 0000	POLY ON	*2-6
1111 0000	1111 0111	System exclusive	*2-2,8

Notes :

*2-1 Note numbers outside the range 24 - 103 are ignored.

*2-2 Received if the corresponding function switch is ON.

*2-3 vvvvvvv = 0 : modulation OFF
 vvvvvvv = 1 - 127 : modulation ON (Depth ignored.)

*2-4 RPC and value (Data Entry) are recognized as follows.

RPC #	value MSB	value LSB	Description
0	0vvv vvvv	0xxx xxxx	BEND RANGE (0-12 semitone, 1 semitone step) xxxxxxx is ignored.
1	0vvv vvvv	0vvv vvvv	MASTER TUNE (-99 - +99 cent, 1 cent step)

*2-5 Program number corresponds to the condition of the 'Sampling Structure'. (See Owner's manual)

*2-6 Mode Messages (123-127) are recognized also as ALL NOTES OFF. OMNI ON, OFF Messages are ignored.

MONO channel range 'mmmm' is recognized as follows.

1) 8-module mode (Normal, Velocity switch)

mmmm	True MONO channel range
0	8
1 - 8	1 - 8
9 - 127	8
Manual set:	8

2) 4-module mode (Detune, Delay, Dual Tone, Velocity-Mix)

mmmm	True MONO channel range
0	4
1 - 4	1 - 4
5 - 127	4
Manual set:	4

In MONO mode, channel of recognized each message is as follows.

message	Control channel mode	
	'BASIC'	'GLOBAL'
Note on/off	individual	individual
Control change	basic	global
Mode message	basic	basic
Program change	basic	global
Pitch bender	individual	individual
Exclusive	basic	basic

* Global channel is equal to "basic channel - 1".
 * And if basic channel is 1, global channel is 16.

*2-7 Ignored in MONO mode.

*2-8 See section 3 (EXCLUSIVE COMMUNICATION).

3. EXCLUSIVE COMMUNICATION

It is possible to communicate with exclusive messages, in NORMAL MODE and SAMPLE DATA DUMP MODE.

NORMAL MODE, in which it is possible to play and generate sound, is explained in section 4, 5.

SAMPLE DATA DUMP MODE has following 4 functions explained in section 5-9.

When 'F1' and 'MIDI' buttons are pressed, it becomes SAMPLE DATA DUMP MODE, and LCD shows "Sample Data Xmt". It means "ONE WAY SAMPLE DATA TRANSMIT".
 Then 'FORWARD' button is pressed, LCD shows "Sample Data Xmts". It means "HANDSHAKE SAMPLE DATA TRANSMIT".
 Then 'FORWARD' button is pressed, LCD shows "Sample Data Rcv". It means "ONE WAY SAMPLE DATA RECEIVE".
 Then 'FORWARD' button is pressed, LCD shows "Sample Data Rcvr". It means "HANDSHAKE SAMPLE DATA RECEIVE".
 When 'BACKWARD' button is pressed, it changes reversely.

All exclusive communications are based on following structure (Roland Exclusive Format Type IV).

Byte	Description
a 1111 0000	Exclusive status
b 0100 0001	Roland ID #
c 0000 nnnn	Device-ID # = MIDI basic channel where nnnn + 1 = channel #
d 0001 0000	Model-ID # (S-10, MKS-100)
e 00aa aaaa	Command-ID #
[f 0bbb bbbb	Address MSB] [] depend on Command-ID
[g 0ccc cccc	Address]
[h 0ddd dddd	Address LSB]
[i 0eee eeee	Data]
[j 0fff ffff	Checksum]
k 1111 0111	End of System Exclusive

Summed value of the all bytes between Command-ID and EOx must be 00H (7 bits). It is not include Command-ID and EOx.

4. EXCLUSIVE COMMUNICATIONS IN NORMAL MODE

4.1 Communication format

4.1.1 Request (One way) RQ1 11H (Recognized only)

Byte	Description
a 1111 0000	Exclusive status
b 0100 0001	Roland ID #
c 0000 nnnn	Device-ID # = MIDI basic channel where nnnn + 1 = channel #
d 0001 0000	Model-ID # (S-10, MKS-100)
e 0001 0001	Command-ID # (RQ1)
f 00aa aaaa	Address MSB
g 00bb bbbb	Address
h 00cc cccc	Address LSB
i 00dd dddd	Size MSB
j 00ee eeee	Size
k 00ff ffff	Size LSB
l 00gg gggg	Checksum
m 1111 0111	End of System Exclusive

4.1.2 Data set (One way) DT1 12H (Transmitted and recognized)

Byte	Description
a 1111 0000	Exclusive status
b 0100 0001	Roland ID #
c 0000 nnnn	Device ID # = MIDI basic channel where nnnn + 1 = channel #
d 0001 0000	Model-ID # (S-10, MKS-100)
e 0001 0010	Command-ID # (DT1)
f 00aa aaaa	Address MSB
g 00bb bbbb	Address
h 00cc cccc	Address LSB
i 00dd dddd	Data
j 00ee eeee	Checksum
k 1111 0111	End of System Exclusive

Notes :

*4-1 If aaaaaa - ccccccc doesn't indicate the top address of the parameter, the message will be ignored.

*4-2 The data size is always ignored and regarded as the size of a parameter which is addressed by aaaaaa - ccccccc.

*4-3 Data of one parameter is sent at one time.
 Data of only one parameter is recognized at one time.

5. Address mapping of parameters

Address of parameter

000000 : Temporary wave parameter block-1 *5-1

0 : 0aaa aaaa : TONE NAME (ASCII) 9 bytes *5-2

9 : 0aaa aaaa : REC KEY 24 - 103

0A : 0aaa aaaa : BANK TUNE 14 - 64 - 114 (-50 - 0 - +50)

0B : 0aaa aaaa : LOOP TUNE 14 - 64 - 114 (-50 - 0 - +50)

0C : 0000 00aa : SCAN MODE 00 : FWD
01 : ALT
10 : BWD

0D : 0000 00aa : LOOP TYPE 00 : 1SHOT
01 : MAN
10 : AUTO

0E : 0000 aaaa : ST (start address)
0000 bbbb
0000 cccc ee ddddcccc bbbbaaaa = 0 - NNNNNN *5-3
0000 dddd
0000 00ee

13 : 0000 aaaa : END (end address)
0000 bbbb
0000 cccc ee ddddcccc bbbbaaaa = 0 - MMMMMM *5-3
0000 dddd
0000 00ee

18 : 0000 aaaa : LP (loop length)
0000 bbbb
0000 cccc ee ddddcccc bbbbaaaa = 0 - MMMMMM *5-3
0000 dddd
0000 00ee

1D : 0000 aaaa : AEN (auto end address)
0000 bbbb
0000 cccc ee ddddcccc bbbbaaaa = 4 - MMMMMM *5-3,4
0000 dddd
0000 00ee

22 : 0000 aaaa : ALP (auto loop length)
0000 bbbb
0000 cccc ee ddddcccc bbbbaaaa = 4 - MMMMMM *5-3,4
0000 dddd
0000 00ee

27 : 0000 000a : KEY FOLLOW 0 : OFF
1 : ON

28 : 0000 000a : PITCH BEND 0 : OFF
1 : ON

29 : 0000 000a : VIBRATO 0 : OFF
1 : ON

2A : 0aaa aaaa : ENV V-SENS 0 - 127

2B : 0aaa aaaa : ENV RATE1 0 - 127

2C : 0aaa aaaa : ENV LEVEL1 0 - 127

2D : 0aaa aaaa : ENV RATE2 0 - 127

2E : 0aaa aaaa : ENV LEVEL2 0 - 127

2F : 0aaa aaaa : ENV RATE3 0 - 127

30 : 0aaa aaaa : ENV LEVEL3 0 - 127

31 : 0aaa aaaa : ENV RATE4 0 - 127

32 : 0aaa aaaa : DYN RANGE 0 - 127

33 : 0aaa aaaa : ABEND RATE 0 - 127

34 : 0aaa aaaa : ABEND DPTH 0 - 127

35 : 0aaa aaaa : SPT KEY#1 24 - 103

36 : 0aaa aaaa : SPT KEY#2 24 - 103 *5-5

37 : 0aaa aaaa : SPT KEY#3 24 - 103

000100 : Temporary wave parameter block-2

37

000200 : Temporary wave parameter block-3

37

000300 : Temporary wave parameter block-4

37

000800 : Performance parameters *5-8

0 : 0aaa aaaa : VIB RATE 0 - 127

1 : 0aaa aaaa : M-VIB DPTH 0 - 127

2 : 0aaa aaaa : D-VIB DPTH 0 - 127

3 : 0aaa aaaa : D-VIB DELAY 0 - 127

4 : 0000 000a : BEND MODE 0 : CONT
1 : CHRM

5 : 0000 000a : ARP SYNC 0 : INT
1 : EXT

6 : 0aaa aaaa : ARP RATE 0 - 127

7 : 0000 00aa : ARP MODE 00 : UP
01 : DOWN
10 : U/D
11 : RND

8 : 0000 00aa : ARP RANGE 00 : 1oct
01 : 2oct
10 : 3oct

9 : 000a aaaa : ARP REPEAT 1 - 16

A : 0000 aaaa : ARP DECAY 1 - 10

B : 0aaa aaaa : V-MX THRS 0 - 127

C : 0aaa aaaa : V-SW THRS 0 - 127

D : 0000 000a : DTUN MOD 0 : FIX
1 : VELO

E : 0aaa aaaa : DTUN RANGE 0 - 127

F : 0000 000a : ABEND DES 0 : BOTH
1 : HALF

10 : 0000 000a : BEND DEST 0 : BOTH
1 : HALF

11 : 0aaa aaaa : DELAY TIME 0 - 127

12 : 0aaa aaaa : DELAY LEVEL 0 - 127

13 : 0aaa aaaa : KEY OFFSET 52 - 64 - 76 (-12 - 0 - +12)

14 : 0aaa aaaa : TRG G-TIME 0 - 127

15 : 0aaa aaaa : TRIGGER KEY #1 23(OFF) - 103

16 : 0aaa aaaa : TRIGGER KEY #2 23(OFF) - 103

17 : 0aaa aaaa : TRIGGER KEY #3 23(OFF) - 103

18 : 0aaa aaaa : TRIGGER KEY #4 23(OFF) - 103

000900 : Structure # of temporary wave parameter blocks *5-7

0 : 0000 aaaa : aaaa : structure # of block-1

0000 bbbb : bbbb : structure # of block-2

0000 cccc : cccc : structure # of block-3

0000 dddd : dddd : structure # of block-4

001000 : 0aaa aaaa : Write command switch *5-8

001001 : 0000 000a : ARPEGGIO on/off 0 : OFF *5-9
1 : ON

001002 : 0aaa aaaa : Sample dump mode switch *5-10

001003 : 0000 00aa : Voice assign mode *5-11
0 : MODE-0
1 : MODE-1
2 : MODE-2
3 : MODE-3

Notes :

*5-1 Temporary wave parameters
Transmitted when the parameter (except TONE NAME) is edited or 'Request data' is received.
When 'Data set' command is recognized, the corresponding parameter will be changed.
1-tone uses 1-temporary block, as following chart.
When layer mode (dual-tone, v-mix, v-switch) is selected, 2nd structure (whose LED is blinking) uses block-2,3.

sampling structure	block # (layer block #)
A	0 (2)
B	0 (2)
C	0 (2)
D	0 (2)
AB	0 (2)
CD	0 (2)
ABCD	0 -
A/B	0/1 (2/3)
C/D	0/1 (2/3)
AB/CD	0/1 -
A/B/C/D	0/1/2/3 -

*5-2 Transmitted only when 'Request data' is received.
If 2 or 4 blocks are used, the top block of them should be used for the communication.

*5-3 These value (NNNNNN, MMMMMM) depends on the sampling structure, as following chart.

structure	NNNNNN	MMMMMM
A	32763 (7FFBH)	32767 (7FFFH)
B	32763 (7FFBH)	32767 (7FFFH)
C	32763 (7FFBH)	32767 (7FFFH)
D	32763 (7FFBH)	32767 (7FFFH)
AB	65531 (FFFBH)	65536 (FFFFH)
CD	65531 (FFFBH)	65536 (FFFFH)
ABCD	131067 (1FFFBH)	131071 (1FFFFH)
A/B	32763 (7FFBH)	32767 (7FFFH)
C/D	32763 (7FFBH)	32767 (7FFFH)
AB/CD	65531 (FFFBH)	65536 (FFFFH)
A/B/C/D	32763 (7FFBH)	32767 (7FFFH)

And the address values must satisfy following conditions.
1: "[start address]+[loop length]" is equal to or less than "[end address]".
2: "[loop length]" is equal to or more than 4.

*5-4 Auto loop addresses are transmitted when it is displayed in edit mode. When Data set command is recognized, the parameter will be changed.

*5-5 If 2 or 4 blocks are used, the SPT KEY # of top block should be used for the communication.
Sampling structure A/B's or C/D's split point is SPT KEY#2.

*5-6 Performance parameters
Transmitted when the parameter (except TONE NAME) is edited or 'Request data' is received.
When Data set command (DT1) is recognized, the corresponding parameter will be changed.

*5-7 Structure # of temporary wave parameter
These can't be changed by Data set command (DT1).
Transmitted only when Request data command (RQ1) is received.
If the data of this address is requested to send, structure # of the temporary wave parameter block-n will be transmitted.
If the block would not be used, structure # is OFH.

structure #	sampling structure
0	A
1	B
2	C
3	D
4	AB
5	CD
6	ABCD
OFH	Not used

*5-8 Write command switch
Transmitted when 'ENTER' button is pressed.
If any data would be written to this address,
write the parameters in temporary area to wave parameter area
of the banks on the condition of the sampling structure.
Request data command (RQ1) for this address is ignored.

*5-9 Arpeggio on/off switch
Transmitted when 'ARPEGGIO' button is pressed.
When Data set command (DT1) is recognized, arpeggio will turn
to ON or OFF.
Request data command (RQ1) for this address is ignored.

*5-10 Sample dump mode switch
Transmitted when 'F1' and 'MIDI' button are pressed.
If any data is written to this address, the mode will change
from NORMAL MODE to SAMPLE DATA DUMP MODE.
The transmitter should be wait more than 10msec for changing
the mode.
Request data command (RQ1) for this address is ignored.

*5-11 Voice assign mode
Transmitted when the voice assign mode is changed with manual
operation on the panel of MKS-100.
When Data set command (DT1) is recognized, the voice assign
mode will be changed.
Request data command (RQ1) for this address is ignored.

The operation of changing voice assign mode is as follows.
Assign Mode-0 ... Pressing 'FWD', 'BWD' and 'MODE' button.
Assign Mode-1 ... Pressing 'FWD', 'BWD' and 'STANDBY' button.
Assign Mode-2 ... Pressing 'FWD', 'BWD' and 'START' button.
Assign Mode-3 ... Pressing 'F1' and 'F2' button in Assign Mode-1.

6. TRANSMITTED EXCLUSIVE MESSAGES IN SAMPLE DATA DUMP MODE

Sample data is determined by sampling structure.
It is transmitted in following order.
WAVE DATA - WAVE PARAMETER - PERFORMANCE PARAMETER

6.1 One way transfer

6.1.1 Data set DT1 12H

Transmitted when 'ENTER' button is pressed
in 'Sample Data Xat' mode.

Byte	Description	
a 1111 0000	Exclusive status	
b 0100 0001	Roland ID #	
c 0000 nnnn	Device-ID # = MIDI basic channel where nnnn + 1 = channel #	
d 0001 0000	Model-ID # (S-10, MKS-100)	
e 0001 0010	Command-ID # (DT1)	
f 0aaa aaaa	Address MSB	*6-1
g 0bbb bbbb	Address	
h 0ccc cccc	Address LSB	
i 0ddd dddd	Data	*6-2
j 0eee eeee	Checksum	
k 1111 0111	End of System Exclusive	

6.2 Handshaking communication

6.2.1 Want to send data WSD 40H

Transmitted when 'ENTER' button is pressed
in 'Sample Data Xat' mode.

Byte	Description	
a 1111 0000	Exclusive status	
b 0100 0001	Roland ID #	
c 0000 nnnn	Device-ID # = MIDI basic channel where nnnn + 1 = channel #	
d 0001 0000	Model-ID # (S-10, MKS-100)	
e 0100 0000	Command-ID # (WSD)	
f 0aaa aaaa	Address MSB	*6-1
g 0bbb bbbb	Address	
h 0ccc cccc	Address LSB	
i 0ddd dddd	Size MSB	*6-3
j 0eee eeee	Size	
k 0fff ffff	Size LSB	
l 0ggg gggg	Checksum	
m 1111 0111	End of System Exclusive	

6.2.2 Request data RQD 41H

Transmitted when 'ENTER' button is pressed
in 'Sample Data Rovs' mode.

Byte	Description	
a 1111 0000	Exclusive status	
b 0100 0001	Roland ID #	
c 0000 nnnn	Device-ID # = MIDI basic channel where nnnn + 1 = channel #	
d 0001 0000	Model-ID # (S-10, MKS-100)	
e 0100 0001	Command-ID # (RQD)	
f 0aaa aaaa	Address MSB	*6-1
g 0bbb bbbb	Address	
h 0ccc cccc	Address LSB	
i 0ddd dddd	Size MSB	*6-3
j 0eee eeee	Size	
k 0fff ffff	Size LSB	
l 0ggg gggg	Checksum	
m 1111 0111	End of System Exclusive	

6.2.3 Data set DAT 42H

Byte	Description	
a 1111 0000	Exclusive status	
b 0100 0001	Roland ID #	
c 0000 nnnn	Device-ID # = MIDI basic channel where nnnn + 1 = channel #	
d 0001 0000	Model-ID # (S-10, MKS-100)	
e 0100 0010	Command-ID # (DAT)	
f 0aaa aaaa	Address MSB	*6-1
g 0bbb bbbb	Address	
h 0ccc cccc	Address LSB	
i 0ddd dddd	Data	*6-2
j 0eee eeee	Checksum	
k 1111 0111	End of System Exclusive	

6.2.4 Acknowledge ACK 43H

Byte	Description
a 1111 0000	Exclusive status
b 0100 0001	Roland ID #
c 0000 nnnn	Device-ID # = MIDI basic channel where nnnn + 1 = channel #
d 0001 0000	Model-ID # (S-10, MKS-100)
e 0100 0011	Command-ID # (ACK)
f 1111 0111	End of System Exclusive

6.2.5 End of data EOD 45H

Byte	Description
a 1111 0000	Exclusive status
b 0100 0001	Roland ID #
c 0000 nnnn	Device-ID # = MIDI basic channel where nnnn + 1 = channel #
d 0001 0000	Model-ID # (S-10, MKS-100)
e 0100 0101	Command-ID # (EOD)
f 1111 0111	End of System Exclusive

6.2.6 Communication error ERR 4BH

Byte	Description
a 1111 0000	Exclusive status
b 0100 0001	Roland ID #
c 0000 nnnn	Device-ID # = MIDI basic channel where nnnn + 1 = channel #
d 0001 0000	Model-ID # (S-10, MKS-100)
e 0100 1110	Command-ID # (ERR)
f 1111 0111	End of System Exclusive

6.2.7 Rejection RJC 4FH

Byte	Description
a 1111 0000	Exclusive status
b 0100 0001	Roland ID #
c 0000 nnnn	Device-ID # = MIDI basic channel where nnnn + 1 = channel #
d 0001 0000	Model-ID # (S-10, MKS-100)
e 0100 1111	Command-ID # (RJC)
f 1111 0111	End of System Exclusive

Notes :

*6-1 Address is determined by sampling structure.
Address of first Data set command (DT1, DAT), Want to send
data (WSD) or Request data (RQD) is as follows.

structure	WAVE DATA	WAVE PARAMETER	PERFORMANCE PARAMETER
A	020000	010000	010800
B	060000	:	:
C	0A0000	:	:
D	0E0000	:	:
AB	020000	:	:
CD	0A0000	:	:
ABCD	020000	:	:
A/B	020000	:	:
C/D	0A0000	:	:
AB/CD	020000	:	:
A/B/C/D	020000	010000	010800

*6-2 Number of data in one Data set command (DT1) is as follows.

structure	WAVE DATA	WAVE PARAMETER	PERFORMANCE PARAMETER
A	128	73	28
B	:	:	:
C	:	:	:
D	:	:	:
AB	:	:	:
CD	:	:	:
ABCD	:	73	:
A/B	:	146	:
C/D	:	:	:
AB/CD	:	:	:
A/B/C/D	128	146	28

*6-3 Size (MSB - LSB) is as follows.

structure	WAVE DATA	WAVE PARAMETER	PERFORMANCE PARAMETER
A	040000	000049	00001C
B	:	:	:
C	:	:	:
D	040000	:	:
AB	080000	:	:
CD	080000	:	:
ABCD	100000	000049	:
A/B	080000	000112	:
C/D	080000	:	:
AB/CD	100000	000112	:
A/B/C/D	100000	000224	00001C

7. RECOGNIZED EXCLUSIVE MESSAGES IN SAMPLE DATA DUMP MODE

Transmitted Sample data is determined by sampling structure.
It must be transmitted in following order.
WAVE DATA - WAVE PARAMETER - PERFORMANCE PARAMETER
*Following exclusive message is recognized only in
SAMPLE DATA DUMP MODE.
When all sample data is received completely,
sampling structure changes accordingly.

7.1 One way receive

7.1.1 Data set DT1 12H

Byte	Description	
a 1111 0000	Exclusive status	
b 0100 0001	Roland ID #	
c 0000 nnnn	Device-ID # = MIDI basic channel where nnnn + 1 = channel #	
d 0001 0000	Model-ID # (S-10, MKS-100)	
e 0001 0010	Command-ID # (DT1)	
f 0aaa aaaa	Address MSB	*7-1
g 0bbb bbbb	Address	
h 0ccc cccc	Address LSB	
i 0ddd dddd	Data	*7-2
j 0eee eeee	Checksum	
k 1111 0111	End of System Exclusive	

7.2 Handshaking communication

7.2.1 Want to send data WSD 40H

Byte	Description
a 1111 0000	Exclusive status
b 0100 0001	Roland ID #
c 0000 nnnn	Device-ID # = MIDI basic channel where nnnn + 1 = channel #
d 0001 0000	Model-ID # (S-10, MKS-100)
e 0100 0000	Command-ID # (WSD)
f 0aaa aaaa	Address MSB
g 0bbb bbbb	Address
h 0ccc cccc	Address LSB
i 0ddd dddd	Size MSB
j 0eee eeee	Size
k 0fff ffff	Size LSB
l 0ggg gggg	Checksum
m 1111 0111	End of System Exclusive

7.2.2 Request data RQD 41H

Byte	Description
a 1111 0000	Exclusive status
b 0100 0001	Roland ID #
c 0000 nnnn	Device-ID # = MIDI basic channel where nnnn + 1 = channel #
d 0001 0000	Model-ID # (S-10, MKS-100)
e 0100 0001	Command-ID # (RQD)
f 0aaa aaaa	Address MSB
g 0bbb bbbb	Address
h 0ccc cccc	Address LSB
i 0ddd dddd	Size MSB
j 0eee eeee	Size
k 0fff ffff	Size LSB
l 0ggg gggg	Checksum
m 1111 0111	End of System Exclusive

7.2.3 Data set DAT 42H

Byte	Description
a 1111 0000	Exclusive status
b 0100 0001	Roland ID #
c 0000 nnnn	Device-ID # = MIDI basic channel where nnnn + 1 = channel #
d 0001 0000	Model-ID # (S-10, MKS-100)
e 0100 0010	Command-ID # (DAT)
f 0aaa aaaa	Address MSB
g 0bbb bbbb	Address
h 0ccc cccc	Address LSB
i 0ddd dddd	Data
j 0eee eeee	Checksum
k 1111 0111	End of System Exclusive

7.2.4 Acknowledge ACK 43H

Byte	Description
a 1111 0000	Exclusive status
b 0100 0001	Roland ID #
c 0000 nnnn	Device-ID # = MIDI basic channel where nnnn + 1 = channel #
d 0001 0000	Model-ID # (S-10, MKS-100)
e 0100 0011	Command-ID # (ACK)
f 1111 0111	End of System Exclusive

7.2.5 End of data ROD 45H

Byte	Description
a 1111 0000	Exclusive status
b 0100 0001	Roland ID #
c 0000 nnnn	Device-ID # = MIDI basic channel where nnnn + 1 = channel #
d 0001 0000	Model-ID # (S-10, MKS-100)
e 0100 0101	Command-ID # (ROD)
f 1111 0111	End of System Exclusive

7.2.6 Communication error ERR 4EH

Byte	Description
a 1111 0000	Exclusive status
b 0100 0001	Roland ID #
c 0000 nnnn	Device-ID # = MIDI basic channel where nnnn + 1 = channel #
d 0001 0000	Model-ID # (S-10, MKS-100)
e 0100 1110	Command-ID # (ERR)
f 1111 0111	End of System Exclusive

7.2.7 Rejection RJC 4FH

Byte	Description
a 1111 0000	Exclusive status
b 0100 0001	Roland ID #
c 0000 nnnn	Device-ID # = MIDI basic channel where nnnn + 1 = channel #
d 0001 0000	Model-ID # (S-10, MKS-100)
e 0100 1111	Command-ID # (RJC)
f 1111 0111	End of System Exclusive

Notes :

*7-1 Address of first Data set command (DT1, DAT), Want to send data (WSD) or Request data (RQD) is as follows.

structure	WAVE DATA	WAVE PARAMETER	PERFORMANCE PARAMETER
A	020000	010000	010800
B	080000	:	:
C	0A0000	:	:
D	0E0000	:	:
AB	020000	:	:
CD	0A0000	:	:
ABCD	020000	:	:
A/B	020000	:	:
C/D	0A0000	:	:
AB/CD	020000	:	:
A/B/C/D	020000	010000	010800

*7-2 Number of data in data set is as follows.

structure	WAVE DATA	WAVE PARAMETER	PERFORMANCE PARAMETER
A	2 - 244	73	28
B	:	:	:
C	:	:	:
D	:	:	:
AB	:	:	:
CD	:	:	:
ABCD	:	73	:
A/B	:	146	:
C/D	:	:	:
AB/CD	:	:	:
A/B/C/D	2 - 244	146	28

Number of data of WAVE DATA must be even.

*7-3 Size (MSB - LSB) is as follows.

structure	WAVE DATA	WAVE PARAMETER	PERFORMANCE PARAMETER
A	040000	000049	00001C
B	:	:	:
C	:	:	:
D	040000	:	:
AB	080000	:	:
CD	080000	:	:
ABCD	100000	000049	:
A/B	080000	000112	:
C/D	080000	:	:
AB/CD	100000	000112	:
A/B/C/D	100000	000224	00001C

8. Address mapping of SAMPLE DATA

Address	Wave parameter of block-1
010000	010000 : Data aaaa : TONE NAME
	9 : 0000 aaaa : SAMPLING STRUCTURE
	A : 0000 aaaa : DESTINATION BANK
	B : 0000 abcd : a BENDER 0 : OFF 1 : ON
	b KEY FOLLOW 0 : OFF 1 : ON
	c VIBRATO 0 : OFF 1 : ON
	d SAMPLING RATE 0 : 30 kHz 1 : 15 kHz
	C : 0000 aabb ;
	aa LOOP MODE 00 : 1SHOT 01 : MAN 10 : AUTO
	bb SCAN MODE 00 : FORWARD 01 : ALTERNATE 10 : BACKWARD
	D : 0000 aaaa ;
	E : 0000 bbbb ;
	bbbb aaaa REC KEY NUMBER
	F : 0000 0000 : dummy
	10 : 0000 0000 : dummy
	11 : 0000 aaaa ;
	12 : 0000 bbbb ;
	13 : 0000 cccc ;
	14 : 0000 dddd ;
	15 : 0000 eeee ;
	16 : 0000 ffff ;
	17 : 0000 gggg ;
	18 : 0000 hhhh ;
	19 : 0000 iiii ;
	1A : 0000 jjjj ;
	1B : 0000 kkkk ;
	1C : 0000 llll ;
	1D : 0000 mmmm ;
	1E : 0000 nnnn ;
	1F : 0000 oooo ;
	20 : 0000 pppp ;
	21 : 0000 qqqq ;
	22 : 0000 rrrr ;
	23 : 0000 ssss ;
	24 : 0000 tttt ;

```

25 | 0000 uvvv |
26 | 0000 wv00 |
27 | 0000 0000 | dummy
28 | 0000 xxyy |
    |           |
    | ww bbbbaaaa dddcccc START ADDRESS
    | uu fffffeee hhhggggg MANUAL LOOP LENGTH
    | vv jjjjjiii lllkkkk MANUAL END ADDRESS
    | xx nnnnmmmm ppppooo AUTO LOOP LENGTH
    | yy rrrrrqqq ttttsasa AUTO END ADDRESS
    |
29 | 0000 aaaa |
2A | 0000 bbbb |
    | bbbbaaaa BANK TUNE
2B | 0000 aaaa |
2C | 0000 bbbb |
    | bbbbaaaa LOOP TUNE
2D | 0000 aaaa |
2E | 0000 bbbb |
    | bbbbaaaa VELOCITY SENSE
2F | 0000 aaaa |
30 | 0000 bbbb |
    | bbbbaaaa ENVELOPE RATE-1
31 | 0000 aaaa |
32 | 0000 bbbb |
    | bbbbaaaa ENVELOPE RATE-2
33 | 0000 aaaa |
34 | 0000 bbbb |
    | bbbbaaaa ENVELOPE RATE-3
35 | 0000 aaaa |
36 | 0000 bbbb |
    | bbbbaaaa ENVELOPE RATE-4
37 | 0000 aaaa |
38 | 0000 bbbb |
    | bbbbaaaa ENVELOPE LEVEL-1
39 | 0000 aaaa |
3A | 0000 bbbb |
    | bbbbaaaa ENVELOPE LEVEL-2
3B | 0000 aaaa |
3C | 0000 bbbb |
    | bbbbaaaa ENVELOPE LEVEL-3
3D | 0000 aaaa |
3E | 0000 bbbb |
    | bbbbaaaa KEY SPLIT POINT-1
3F | 0000 aaaa |
40 | 0000 bbbb |
    | bbbbaaaa KEY SPLIT POINT-2
41 | 0000 aaaa |
42 | 0000 bbbb |
    | bbbbaaaa KEY SPLIT POINT-3
43 | 0000 aaaa |
44 | 0000 bbbb |
    | bbbbaaaa DYNAMIC SENS
45 | 0000 aaaa |
46 | 0000 bbbb |
    | bbbbaaaa AUTO BEND RATE
47 | 0000 aaaa |
48 | 0000 bbbb |
    | bbbbaaaa AUTO BEND DEPTH
010049 |
: | Wave parameter of block-2
010111 |
: |
010112 |
: | Wave parameter of block-3
01015A |
: |
01015B |
: | Wave parameter of block-4
010224 |
: |
010800 | Performance parameter
0 | 0000 aaaa |
1 | 0000 bbbb |
    | bbbbaaaa EXTERNAL TRIGGER KEY NUMBER-1
2 | 0000 aaaa |
3 | 0000 bbbb |
    | bbbbaaaa EXTERNAL TRIGGER KEY NUMBER-2
4 | 0000 aaaa |
5 | 0000 bbbb |
    | bbbbaaaa EXTERNAL TRIGGER KEY NUMBER-3
6 | 0000 aaaa |
7 | 0000 bbbb |
    | bbbbaaaa EXTERNAL TRIGGER KEY NUMBER-4
8 | 0000 aaaa |
9 | 0000 bbbb |
    | bbbbaaaa EXTERNAL TRIGGER TRIGGER TIME
A | 0000 aaaa |
B | 0000 bbbb |
    | bbbbaaaa ARPEGGIO RATE
C | 0000 aa00 | ARPEGGIO SYNC 00 : INTERNAL CLOCK
    | 01 : EXTERNAL CLOCK
D | 0000 aabb |
    | aa ARPEGGIO MODE 00 : UP
    | 01 : DOWN
    | 10 : UP/DOWN
    | 11 : RANDOM
    | bb ARPEGGIO RANGE 00 : 1 OCTAVE
    | 01 : 2 OCTAVE
    | 10 : 3 OCTAVE
E | 0000 aaaa |
F | 0000 bbbb |
    | bbbbaaaa ARPEGGIO REPEAT TIME
10 | 0000 aaaa |
11 | 0000 bbbb |
    | bbbbaaaa ARPEGGIO DECAY RATIO
12 | 0000 aaaa |
13 | 0000 bbbb |
    | bbbbaaaa VIBRATO RATE
14 | 0000 aaaa |
15 | 0000 bbbb |
    | bbbbaaaa MANUAL VIBRATO DEPTH

```

```

16 | 0000 aaaa |
17 | 0000 bbbb |
    | bbbbaaaa DELAY VIBRATO DEPTH
18 | 0000 aaaa |
19 | 0000 bbbb |
    | bbbbaaaa DELAY VIBRATO TIME
1A | 0000 aaaa |
1B | 0000 bbbb |
    | bbbbaaaa DELAY TIME OF DELAY MODE
1C | 0000 aaaa |
1D | 0000 bbbb |
    | bbbbaaaa DELAY LEVEL OF DELAY MODE
1E | 0000 aaaa |
1F | 0000 bbbb |
    | bbbbaaaa DELAY KEY OFFSET OF DELAY MODE
20 | 0000 aaaa |
21 | 0000 bbbb |
    | bbbbaaaa DETUNE RANGE OF DETUNE MODE
22 | 0000 aaaa |
23 | 0000 bbbb |
    | bbbbaaaa THRESHOLD LEVEL
    | OF VELOCITY MIX MODE
24 | 0000 aaaa |
25 | 0000 bbbb |
    | bbbbaaaa THRESHOLD LEVEL
    | OF VELOCITY SWITCH MODE
26 | 0000 abcd |
    | a AUTO BEND DESTINATION OF DETUNE MODE
    | 0 : BOTH
    | 1 : HALF
    | b BEND DESTINATION OF DETUNE MODE
    | 0 : BOTH
    | 1 : HALF
    | c BENDER MODE 0 : CONTINUOUS
    | 1 : CHROMATIC
    | d DETUNE MODE 0 : FIX
    | 1 : VELOCITY
27 | 0000 0000 | dummy
020000 | Wave data of bank-1
0 | 0aaa aaaa |
1 | 0bbb bb00 |
    | aaaa aaabbbb Wave data
    | (12 bit 2's complement)
: |
057F7F |
: |
060000 |
: | Wave data of bank-2
097F7F |
: |
0A0000 |
: | Wave data of bank-3
0D7F7F |
: |
0E0000 |
: | Wave data of bank-4
127F7F |
: |

```

9. Sequence of communication

9.1 When one way data set of WAVE DATA is transmitted

this unit	message	objective unit
	DT1(WAVE DATA)	----->
	* time interval about 20 ms	
	DT1(WAVE DATA)	----->
	:	
	DT1(WAVE DATA)	----->
	DT1(WAVE PARAMETER)	----->
	{ DT1(WAVE PARAMETER) }	----->
	DT1(PERFORMANCE PARAMETER)	----->

9.2 When one way data set of WAVE DATA is received

this unit	message	objective unit
	<----- DT1(WAVE DATA)	
	* wait time more than 20 ms	
	<----- DT1(WAVE DATA)	
	:	
	<----- DT1(WAVE DATA)	
	<----- DT1(WAVE PARAMETER)	
	{ <----- DT1(WAVE PARAMETER) }	
	<----- DT1(PERFORMANCE PARAMETER)	

9.3 When want to send data is received

this unit	message	objective unit
	<----- WSD(WAVE DATA)	
	ACK ----->	
	<----- DAT(WAVE DATA)	
	ACK ----->	
	:	
	<----- DAT(WAVE DATA)	
	ACK ----->	
	<----- EOD	
	ACK ----->	
	<----- WSD(WAVE PARAMETER)	
	ACK ----->	
	<----- DAT(WAVE PARAMETER)	
	ACK ----->	
[<----- DAT(WAVE PARAMETER)]	
[ACK ----->	
	<----- EOD	
	ACK ----->	
	<----- WSF(PERFORMANCE PARAMETER)	
	ACK ----->	
	<----- DAT(PERFORMANCE PARAMETER)	
	ACK ----->	
	<----- EOD	
	ACK ----->	

9.4 When request data is received

this unit	message	objective unit
	<----- RQD(WAVE DATA)	
	DAT(WAVE DATA) ----->	
	<----- ACK	
	:	
	DAT(WAVE DATA) ----->	
	<----- ACK	
	EOD ----->	
	<----- ACK	
	<----- RQD(WAVE PARAMETER)	
	DAT(WAVE PARAMETER) ----->	
	<----- ACK	
[DAT(WAVE PARAMETER) ----->]	
[<----- ACK]	
	EOD ----->	
	<----- ACK	
	<----- RQD(PERFORMANCE PARAMETER)	
	DAT(PERFORMANCE PARAMETER) ----->	
	<----- ACK	
	EOD ----->	
	<----- ACK	

Notes :

- *When it receives ERR, it sends same data set again.
- *When a transmitting MKS-100 receives any illegal command (ie. a note on etc.), it ignores and waits for legal command.
- *When a receiving MKS-100 receives any illegal command (ie. a note on etc.), it ignores and waits for legal command.
- *It sends RJC and stops sample dump sequence immediately, when sampling structure button is pressed.
- *It stops the sequence immediately when it receives RJC.

8-voice digital sampling module

MODEL **MKS-100 MIDI Implementation Chart**

Date: Oct. 18 1986
Version: 1.00

Function.....		Transmitted	Recognized	Remarks
Basic Channel	Default Changed	1-16 1-16	1-16 1-16	Memorized
Mode	Default Messages Altered	× × *****	Mode 3, 4 Poly, Mono	Memorized Omni on, off ignored
Note Number	True voice	× *****	24-103 24-103	Depends on Key Range
Velocity	Note ON Note OFF	× ×	○ v=1-127 ×	
After Touch	Key's Ch's	× ×	× ×	
Pitch Bender		×	*1 0-12 semi-tone	9 bit resolution
Control Change	1 64 100,101 6,38	× × *1, *2 (0, 1) *1, *2	*1 *1 *1, *2 (0, 1) *1, *2	Modulation Hold 1 RPC LSB, MSB Data Entry MSB, LSB
Prog Change	True #	*1 0-122 *****	*1 0-127 0-127	
System Exclusive		*1	*1	
System Common	Song Pos Song Sel Tune	× × ×	× × ×	
System Real Time	Clock Commands	× ×	× ×	
Aux Messages	Local ON/OFF All Notes OFF Active Sense Reset	× × × ×	× ○ (123-127) ○ ×	
Notes		*1 Can be set to ○ or × manually, and memorized. RPC=Registered parameter control number. RPC #0 : Pitch bend sensitivity RPC #1 : Master fine tuning Parameter values are given by Data Entry.		

Mode 1 : OMNI ON, POLY
Mode 3 : OMNI OFF, POLY

Mode 2 : OMNI ON, MONO
Mode 4 : OMNI OFF, MONO

○ : Yes
× : No

SPECIFICATIONS

MKS-100: MIDI Digital Sampler

Voice: 8 Voice Polyphonic

Front Panel

- Structure Buttons
- F1/ ► Button
- F2/ ◀ Button
- Tune Button
- Parameter Button
- Modify Button
- Performance Button
- MIDI Button
- Enter Button
- Forward Button
- Backward Button
- Record Button
- Mode Button
- Stand-by Button
- Start Button
- Load Button
- Save Button
- Input Jack
- Input Level Switch
- Headphone Jack
- Start Jack
- MIDI Message Indicator
- Mono Mode Indicator
- Power Switch

Performance Controllers

- Alpha Dial
- Volume Knob
- Recording Level Knob

Display

16 figure Liquid Crystal Display (back lit)

Disk Drive

2.8 inch Quick Disk (QD)

Rear Panel

- Output Jack
- Output Level Switch
- MIDI Connectors (IN, OUT, THRU)

Dimensions

483(W) × 410(D) × 90(H) mm/
19-1/4" × 16-1/8" × 3-7/16" (without the
QD Case)

Weight

7 kg/15 lb 7 oz

Power Consumption

19 W

Accessories

- Connection Cable (PJ-1)
- Sample Sound QD

Options

- Headphones: RH-100
- Pedal Switch: DP-2
- Pad: PD-20
- Microphone
- Quick Disk: QD-10

 Roland®

10476

UPC 10476

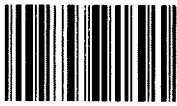

18981

MKS-100

 Roland

96-11-AG1-1B

Free Manuals Download Website

<http://myh66.com>

<http://usermanuals.us>

<http://www.somanuals.com>

<http://www.4manuals.cc>

<http://www.manual-lib.com>

<http://www.404manual.com>

<http://www.luxmanual.com>

<http://aubethermostatmanual.com>

Golf course search by state

<http://golfingnear.com>

Email search by domain

<http://emailbydomain.com>

Auto manuals search

<http://auto.somanuals.com>

TV manuals search

<http://tv.somanuals.com>