

PM350b Personal Monitor Mixer Plus

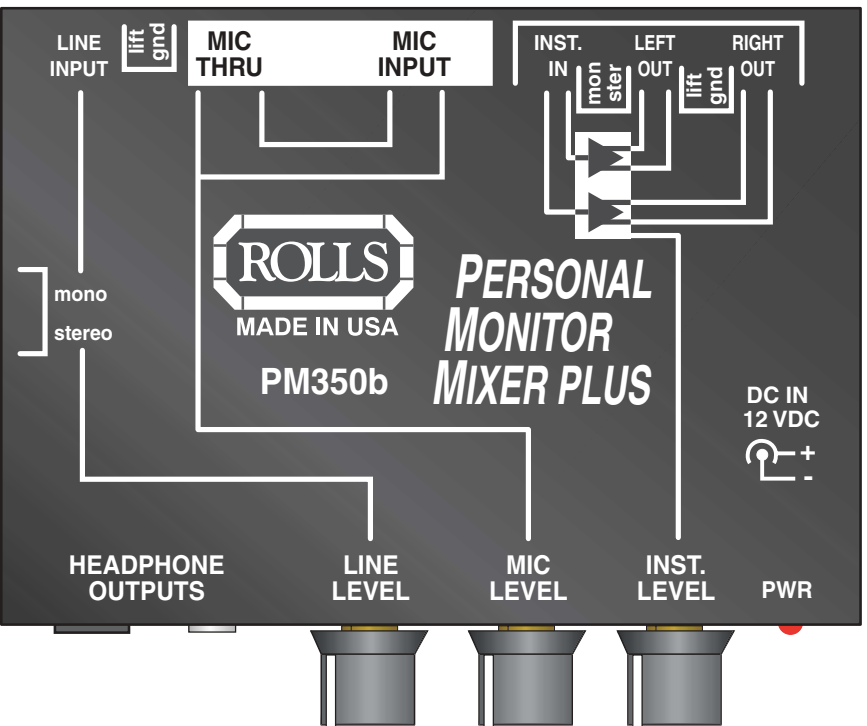

Owners Manual

LIMITED WARRANTY

This product is warranted to the original consumer purchaser to be free from defects in materials and workmanship under normal installation, use and service for a period of one (1) year from the date of purchase as shown on the purchaser's receipt.

The obligation of Rolls Corporation under this warranty shall be limited to repair or replacement (at our option), during the warranty period of any part which proves defective in material or workmanship under normal installation, use and service, provided the product is returned to Rolls Corporation, TRANSPORTATION CHARGES PREPAID. Products returned to us or to an authorized Service Center must be accompanied by a copy of the purchase receipt. In the absence of such purchase receipt, the warranty period shall be one (1) year from the date of manufacture.

This warranty shall be invalid if the product is damaged as a result of defacement, misuse, abuse, neglect, accident, destruction or alteration of the serial number, improper electrical voltages or currents, repair, alteration or maintenance by any person or party other than our own service facility or an authorized Service Center, or any use violative of instructions furnished by us.

This one-year warranty is in lieu of all expressed warranties, obligations or liabilities. ANY IMPLIED WARRANTIES, OBLIGATIONS, OR LIABILITIES, INCLUDING BUT NOT LIMITED TO THE IMPLIED WARRANTIES OF MERCHANTABILITY AND FITNESS FOR A PARTICULAR PURPOSE, SHALL BE LIMITED IN DURATION TO THE ONE YEAR DURATION OF THIS WRITTEN LIMITED WARRANTY. Some states do not allow limitations on how long an implied warranty lasts, so the above limitation may not apply to you.

IN NO EVENT SHALL WE BE LIABLE FOR ANY SPECIAL, INCIDENTAL OR CONSEQUENTIAL DAMAGES FOR BREACH OF THIS OR ANY OTHER WARRANTY, EXPRESSED OR IMPLIED, WHATSOEVER. Some states do not allow the exclusion or limitation of special, incidental or consequential damages so the above limitation or exclusion may not apply to you. This warranty gives you specific legal rights, and you may also have other rights which vary from state to state.

PM350b Personal Monitor Mixer Plus

The PM350 mixes an XLR mic signal, 1/4 TRS stereo or mono instrument signal, and a 1/4" TRS stereo or mono monitor signal together for headphone monitoring.

- XLR Mic In & Pass Through
 - Stereo or Mono 1/4" Line Input
 - "Phantom" powering via the Line In
 - Stereo or mono 1/4" Instrument In with built-in DI outs
 - Switchable ground lift on balanced outputs
 - Two Headphone Outputs 1/4" and 1/8"
- PM350b Monitor Mix

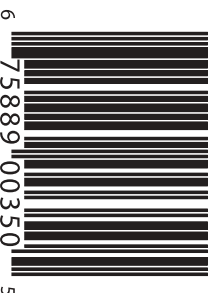

Rolls Corporation
Salt Lake City, UT
1/03

INTRODUCTION

Thank you for your purchase of the PM350b Personal Monitor Mixer Plus. This unit mixes a microphone signal with a 1/4" Tip-Ring-Sleeve stereo or mono instrument level signal and a 1/4" TRS stereo or mono monitor signal. The Mic Input and Thru jacks have a switchable ground lift, as do the 1/4" TRS Instrument Outputs. The instrument input connects to two independent 1/4" TRS balanced outputs via electronic balancing circuits.

The PM350b is designed for performers who want to monitor their own sounds, such as their vocals and instruments, with the main mix via headphones or earphones. It's very popular with drummers who need to mix a click track with a monitor signal. Church choir singers love the PM350b to monitor their voices over the musicians.

The PM350b is shipped with an external AC adapter.

INSPECTION

1. Unpack and inspect the PM350b box and package. If obvious physical damage is noticed, contact the carrier immediately to make a damage claim. We suggest saving the shipping carton and packing materials for safely transporting the unit in the future.

2. Please complete the Warranty Registration Card and return it to the factory.

TABLE OF CONTENTS

INTRODUCTION	1
INSPECTION	1
TABLE OF CONTENTS	1
DESCRIPTION	2
CONNECTION	3
OPERATION	4
SCHEMATIC	5
SPECIFICATIONS	6
WARRANTY	BACK COVER



This symbol indicates that there are important operating and maintenance instructions in the literature accompanying this unit.

SPECIFICATIONS

Max Input Level:	-20 dB XLR, +40 dB Line, +15 dB Instrument
Inst. Input Impedance:	50K ohms
Inst. Output Freq. Response:	10 - 30 kHz +/- 3 dB
Output Impedance, Hdphn:	10 ohms
Output Impedance, Inst.:	2 ea; 100 ohms balanced
Gain:	20 dB 1/4", 50 dB XLR
Hdphn Freq. Response:	20 - 20 kHz
S/N Ratio:	90 dB
Power:	9 - 16 VDC
Size (W x H x D):	4.5" x 3.3" x 1.5"
Weight:	1 lb (.45 Kg)

WARNING

USING THIS SYSTEM AT EXCESSIVE VOLUMES CAN CAUSE PERMANENT HEARING DAMAGE.

USE AS LOW A VOLUME AS POSSIBLE

In order to use this system safely, avoid prolonged listening at excessive sound pressure levels. Please use the following guidelines established by the Occupational Safety Health Administration (OSHA) on maximum time exposure to sound pressure levels before hearing damage occurs.



90 dB SPL at 8 hours
95 dB SPL at 4 hours
100 dB SPL at 2 hours
105 dB SPL at 1 hour
110 dB SPL at 1/2 hour
115 dB SPL at 15 minutes

120 dB SPL - **avoid or damage may occur**

It is difficult to measure the exact Sound Pressure Levels (SPL) present at the eardrum in live applications. In addition to the volume setting on this Personal Monitor unit, the SPL in the ear is affected by ambient sound from floor wedges or other devices. The isolation provided by the fit of quality earphones is also an important factor in determining the SPL in the ear.

Follow these guidelines in the use of this product to protect your ears from damage:

1. Turn up the volume only to the point where hearing is comfortable.
2. Ringing in the ears may indicate that the levels are too high. Lower the volume level.
3. Have your ears checked by an audiologist on a regular basis. If you experience wax buildup in your ears, stop using the system until an audiologist has examined your ears.
4. Wipe the earphones with an antiseptic before and after use to avoid infections. Stop using the earphones if they are causing great discomfort or infection.

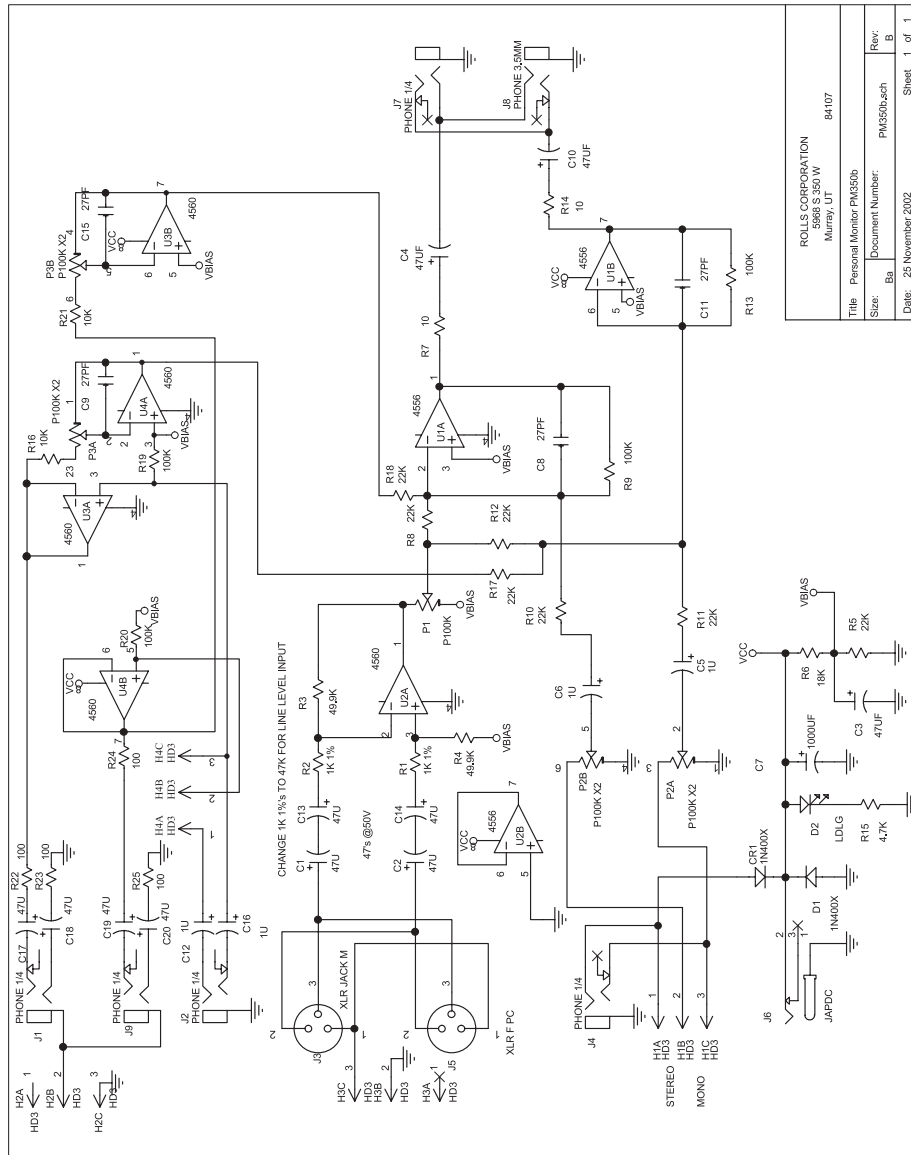

LINE INPUT: 1/4" TRS stereo jack for connection to a line level source such as a mixer monitor/auxiliary output, cassette player output, CD player output etc.

ground lift: Header jumper for disconnecting chassis ground from pin 1 of the Mic Input and Mic Thru.

MIC THRU: XLR jack paralleled (hard-wired) to the MIC INPUT jack for pass-through to a mixer or other microphone level input device.

MIC INPUT: XLR balanced jack for connection to a condenser or dynamic microphone.

INSTRUMENT INPUT: 1/4" TRS stereo jack for connection to an instrument or line level signal such as a guitar processor, keyboard, or instrument preamp output.

MONO/STEREO JUMPER: Selects whether the INST. INPUT jack is mono or stereo.

LEFT/RIGHT OUTPUTs: Electronically balanced 1/4" TRS outputs of the Instrument Input.

ground lift: Header jumper for disconnecting chassis ground from the 1/4" TRS instrument output jacks.

MONO/STEREO JUMPER (Located below the LINE INPUT): Selects whether the LINE INPUT jack is mono or stereo. *NOTE: When in MONO mode, the ring of the jack may be used to "phantom power" the PM350. See the OPERATION section for details.*

DC IN 12 VDC: For connection to the external Rolls PS27 power adapter.

HEADPHONE OUTPUTS: 1/4" Stereo jack, and 1/8" stereo jack for connection to stereo headphones or earphones.

LINE LEVEL: Adjusts the level of signal from the LINE INPUT to the headphone mix.

MIC LEVEL: Adjusts the level of signal from the MIC INPUT to the headphone mix.

INST. LEVEL: Adjusts the level of signal from the INST. INPUT to the headphone mix.

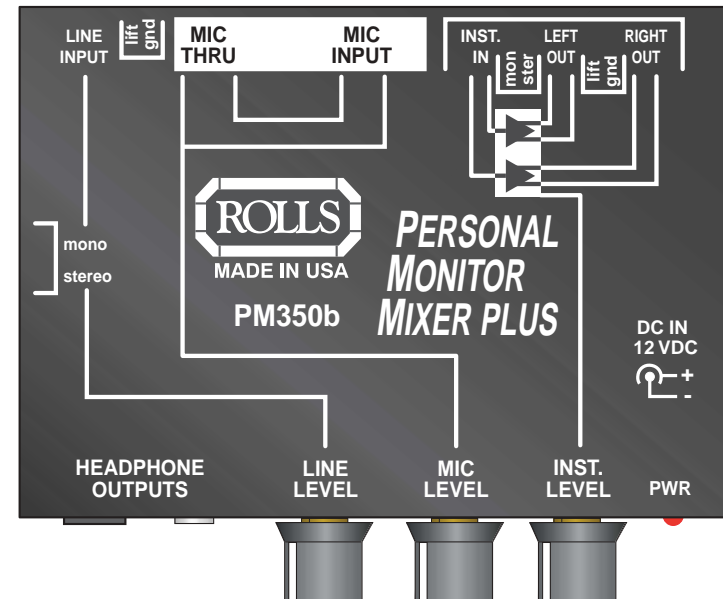

CONNECTION

The diagram below shows an example of how to connect the PM350b for proper operation.

- The LINE INPUT connects to either a 1/4" stereo or mono plug. If this plug is Tip-Ring-Sleeve stereo and you're sending a stereo signal to this jack, select the STEREO setting of the Mono/Stereo jumper. If the plug is Tip-Sleeve mono, select the MONO setting of the Mono/Stereo jumper. The MONO setting is also the proper selection if you are phantom powering the PM350b.

- The MIC INPUT connects to either a dynamic or condenser microphone via a standard XLR cable. If you are using a condenser type mic, you will need to power it via phantom power from the mixer which connects to the MIC THRU jack. This jack will pass the phantom power from a mixer on to the microphone.

- Connect the MIC THRU jack to the mixer or snake as necessary.

- The INSTRUMENT INPUT connects to a guitar preamp output, keyboard, or any stereo or mono instrument level signal. Again, select stereo or mono.

- The INSTRUMENT OUTPUTs are electronically isolated and converts the high impedance INSTRUMENT INPUT signal to low impedance so it can be sent down a balanced line. These signals may then be plugged into an XLR input on a mixer or snake by using a 1/4" TRS to XLR cable. Note that the level of this signal may be too high for a mixer's microphone input - you may experience distortion. In this event, turn down the instrument connected to the PM350 INSTRUMENT INPUT, pad the input to the mixer's mic input, or trim down the mic input.

Connect your headphones or earphones to the proper Headphone Output.

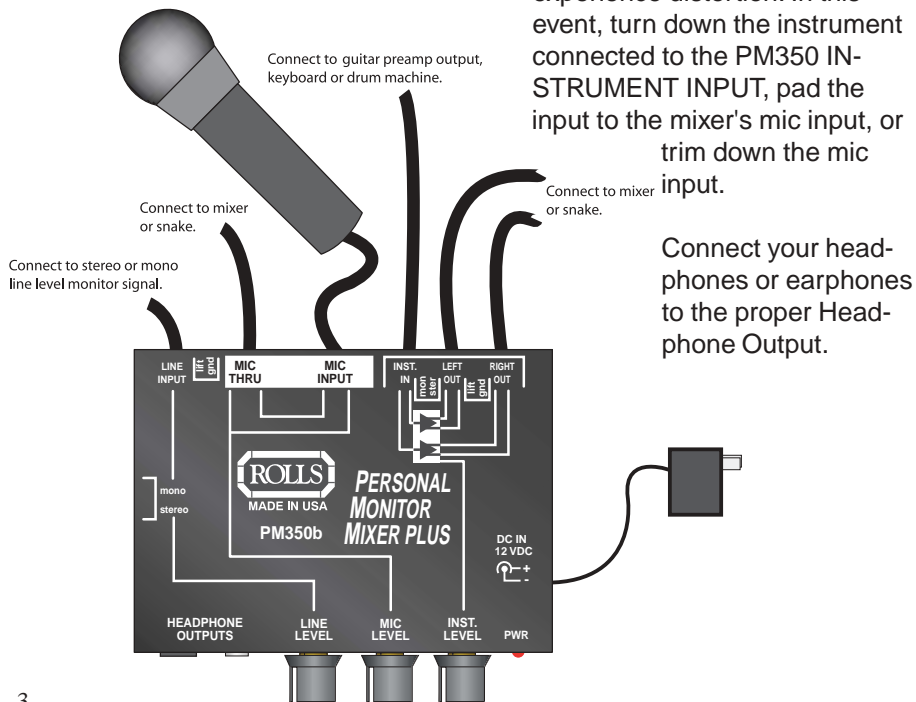

3

OPERATION

Make sure the Rolls PS27 12VDC power supply is connected to an active AC outlet, and all audio connections are in place.

- Setting the Mono/Stereo jumpers; If the input to the LINE INPUT or INSTRUMENT INPUT is a Tip-Ring-Sleeve stereo signal, set the Mono/Stereo jumper for stereo operation as shown here.

If the signal to the LINE INPUT or INSTRUMENT INPUT is Tip-Sleeve mono, move the jumper to connect the "mono" pins.

NOTE: If the LINE INPUT mono/stereo jumper is missing, only one side of the headphones/earphones will work.

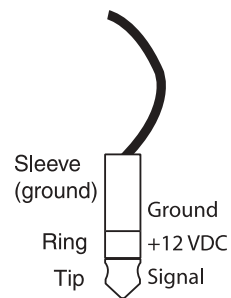
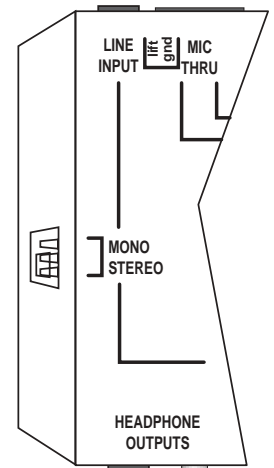

- Phantom Powering the PM350b

A very useful feature of the PM350b is the ability to send the 12VDC power to the unit via the LINE INPUT ring connection. Make sure the Mono/Stereo jumper is in the MONO position. Connect the 12VDC to the Ring of the TRS plug as shown here.

ROLLS WILL NOT BE HELD RESPONSIBLE FOR DAMAGE DONE TO THE PM350 AS A RESULT OF IMPROPER USE OF THIS FEATURE. IF YOU ARE NOT SURE HOW TO DO THIS CORRECTLY, CONTACT A QUALIFIED SERVICE TECHNICIAN.

NOTE: This unit cannot be powered by standard 48 Volt Phantom Power supplied by mixers, phantom power adapters etc. The current (amperes) is insufficient to power the PM350b. Also, any voltage greater than 16 VDC will damage the unit.

GROUND LIFT

The Mic Input and Mic Thru have a ground lift jumper provided to lift the XLR pin 1 from chassis ground. The 1/4" TRS Instrument Outputs also have this feature. If you experience a "hum" on the microphone or instrument outputs, lifting the ground may eliminate the problem. To lift the ground, use a pair of needle-nose pliers and carefully remove the header jumper. Replace the jumper on the two pins labeled "lift".

4

Free Manuals Download Website

<http://myh66.com>

<http://usermanuals.us>

<http://www.somanuals.com>

<http://www.4manuals.cc>

<http://www.manual-lib.com>

<http://www.404manual.com>

<http://www.luxmanual.com>

<http://aubethermostatmanual.com>

Golf course search by state

<http://golfingnear.com>

Email search by domain

<http://emailbydomain.com>

Auto manuals search

<http://auto.somanuals.com>

TV manuals search

<http://tv.somanuals.com>