

# Electric and Gas Dryers

# Use and Care Guide

## ROPER

Appliances

EL4030V  
 EL5030V  
 EL6050V  
 GL4030V  
 GL5030V  
 GL6050V

Thank you for choosing a Roper appliance. This guide will help you operate and maintain your new, quality-built Roper electric or gas dryer. Keep this guide in a safe place for future reference.

### First ... complete all of the Installation Instructions

before attempting to operate your dryer.

### Next ... complete and mail the Product Registration Card

This card enters your warranty into our warranty system insuring efficient claim processing. It can be used as a proof of purchase for insurance claims and helps Roper to contact you immediately in the unlikely event of a product safety recall.

### Please remember

It is your responsibility to be sure that your dryer:

- Is properly installed by a qualified person.\*

- Is installed and leveled on a floor that can support the weight of the dryer.\*
- Is located in a well ventilated room where the temperature is above 45°F (7.2°C).
- Is properly connected to a grounded electrical circuit that meets the electrical requirements.\*
- Is properly connected to fuel and exhaust systems.\*
- Is not installed against drapes or curtains.\*
- Is used only for the job it was designed to do.
- Is not used by children or anyone unable to operate it properly.
- Is properly maintained.

\* See Installation Instructions provided.

### Energy-saving tips

- Use dryer during non-peak, energy-usage hours. Contact your power company for the most energy-efficient times.
- Dry only full loads.
- Do Not add wet items to partially dried load.
- Do Not overdry items.
- Shorten drying times by:
  - cleaning lint screen before or after each use.
  - properly exhausting the dryer.
  - using the dryer in a warm room.
  - not opening the dryer door often.
- loading the dryer with similar fabric weights and types.
- not overloading the dryer.
- drying loads one immediately after another.

# Important Safety Instructions

## **⚠️ WARNING**

Reduce risk of fire, electrical shock, or personal injury when using your dryer, by following basic precautions, including the following:

- Read all instructions before using your dryer.
- Do Not dry items cleaned in, washed in, soaked in or spotted with gasoline, dry-cleaning solvents, paint, wax or other flammable or explosive substances in the dryer. The fumes can create a fire or explosion. Always hand-wash and air-dry fabrics containing these materials.
- Do Not allow children to play on or inside the dryer. Close supervision of children is necessary when the dryer is used near them.
- Before the dryer is removed from service or discarded, remove the door to prevent accidental entrapment.
- Do Not reach into the dryer if the drum is moving.
- Do Not install or store dryer where it will be exposed to the weather.
- Do Not tamper with controls.
- You are responsible for making sure that your dryer is installed, repaired and parts replaced by a qualified person.
- Do Not use fabric softeners or products to eliminate static unless recommended by the manufacturer of those products.
- Do Not use heat to dry articles containing foam rubber, similarly textured rubber-like materials and other heat-sensitive fabrics. Always use No Heat/Fluff setting or line-dry.
- Clean lint screen before or after each load.
- Do Not let dust, lint, paper, rags, chemicals, etc. pile up around or under the dryer or its exhaust opening.
- The interior of the dryer and exhaust system should be cleaned periodically by a qualified person.
- Dryer must be electrically grounded. See Installation Instructions.
- Do Not operate the dryer if:
  - it is not working properly (i.e. noisy, too hot).
  - it is damaged.
  - parts are missing (i.e. door latch).
  - all panels are not in place.
  - the lint screen is loose, damaged or missing.
- Unplug power supply cord or turn off electrical power before servicing the dryer. Shut off GAS VALVE if it is a gas dryer. Shut off gas valve before leaving on vacation if it is a gas model.

**Save these Instructions**

### FOR YOUR SAFETY

If you smell gas:

1. Open windows.
2. Don't touch electrical switches.
3. Extinguish any open flame.
4. Immediately call your gas supplier.

### FOR YOUR SAFETY

**Do Not store or use gasoline or other flammable vapors and liquids in the vicinity of this or any other appliance. The fumes can create a fire hazard or explosion.**

# Contents

Page No.

|   |     |
|---|-----|
| Product Registration _____                        | 1   |
| Energy-saving tips _____                          | 1   |
| Important Safety Instructions _____               | 2   |
| Before you dry _____                              | 2   |
| Using your dryer                                  |     |
| Loading your dryer _____                          | 3   |
| Select a cycle and time _____                     | 3   |
| Select temperature _____                          | 3   |
| To start _____                                    | 3   |
| To stop _____                                     | 3   |
| To change settings _____                          | 3   |
| Model EL4030/GL4030 _____                         | 4   |
| Model EL5030/GL5030 _____                         | 5   |
| Model EL6050/GL6050 _____                         | 6-7 |
| Drying Tips                                       |     |
| Load sizes _____                                  | 7   |
| Dryer fabric softeners _____                      | 7   |
| Drying special items _____                        | 7   |
| Common Laundering Problems _____                  | 8-9 |
| Caring for your dryer                             |     |
| Cleaning the lint screen _____                    | 10  |
| Cleaning lint from inside the dryer cabinet _____ | 10  |
| Cleaning the dryer interior _____                 | 10  |
| Cleaning the cabinet exterior _____               | 10  |
| Before you go on vacation _____                   | 10  |
| Before you call for service _____                 | 11  |
| Warranty _____                                    | 12  |
| How to get service or assistance _____            | 12  |

## Before you dry

- Check garments to make sure all spots and stains were removed during the wash. Do Not tumble dry if stains still exist. Heat may permanently set stains. Rewash stains, if necessary.
- Turn pockets of heavy items inside out for even drying.
- Empty all pockets.
- Turn fabrics that are lint-takers and dark items inside out to help prevent lint pickup.
- Remove heat-sensitive trims.
- Tie strings and sashes to prevent tangling.
- Close zippers, snaps and hooks to avoid snagging other items. Remove pins, buckles and other hard objects to avoid scratching the dryer drum.

# Using your dryer

## A. Loading your dryer

(Cycles and temperature suggestions vary by model. See your console and Pages 4-7 for specific model information.)

| Sort Load   | Suggested Cycle  | Suggested Temperature   |
|---|--|---|
| <b>Cottons and Linens</b><br><i>Extra Heavy</i> — Bedspreads, mattress pads, quilts, etc.<br><i>Heavyweight</i> — Towels, jeans, corduroys, work clothes<br><i>Mediumweight</i> — Sheets, pillowcases, dresses, shirts, diapers<br><i>Lightweight</i> — Batistes, organdies, lingerie | Auto-Sense Heavy<br>(Models 6050/5030)<br><br>Special Dry (Model 4030)   | (For Model 6050 temperature settings, see Page 7)<br>Cotton/Perm Press-High<br>(Model 5030)<br>Normal (Model 4030)  |
| <b>Permanent Press, Synthetics and Blends</b><br><i>Heavyweight</i> — Work clothes, jackets, raincoats, etc.<br><i>Mediumweight</i> — Shirts, play clothes, sheets, slacks<br><i>Lightweight</i> — Lingerie, blouses, dresses   | Auto Sense Permanent Press<br>(Models 6050/5030)<br><br>Permanent Press (Model 4030)<br>(See Page 4 for time settings)   | (For Model 6050 temperature settings, see Page 7)<br>Cotton/Perm Press-High<br>(Model 5030)<br>Normal (Model 4030)  |
| <b>Knits</b><br><i>Heavyweight</i> — cottons, rayons, blends, T-shirts, slacks, shirts, etc.<br><br><i>Medium and Lightweight</i> — Synthetics (polyester, acrylic, etc.) and blends, lingerie, blouses, dresses, etc.  | Auto-Sense Permanent Press<br>(Models 6050/5030)<br><br>Permanent Press (Model 4030)<br>40-50 minutes<br><br>Auto-Sense Permanent Press<br>(Models 6050/5030)<br>Permanent Press (Model 4030)<br>30-40 minutes | Medium-Low (Model 6050)<br>Cotton/Perm Press-High<br>(Model 5030)<br>Normal (Model 4030)<br><br>Knits/Delicate Low (Model 6050)<br>Knits Low (Model 5030)<br>Knits Low (Model 4030) |
| <b>Delicate Fabrics</b><br><br>Sheer curtains (2 or 3 panels)<br>Gauze, lace, etc.  | Auto-Sense Permanent Press<br>(Models 6050/5030)<br>Permanent Press (Model 4030)<br>20-30 minutes<br>15-20 minutes   | Ex Low (Model 6050)<br>Knits Low (Model 5030)<br>No Heat/Fluff (Model 4030)   |

## WARNING

**FIRE HAZARD:** Drying rubber, plastic and other heat-sensitive materials with heat can damage them or cause a fire.

**Rubber, Plastic, Heat-sensitive Fabrics**  
 Foam Rubber — Pillows, bras, stuffed toys  
 Plastic — Shower curtains, tablecloths  
 Rubber-backed rugs  
 Olefin, polypropylene, sheer nylon

**Timed settings**  
 20-30 minutes  
 20-30 minutes  
 40-50 minutes  
 15-20 minutes

No Heat/Fluff (Model 6050)  
 Timed Dry (Model 5030)  
 Permanent Press (Model 4030)

(For Model 6050, see No Heat/Fluff, Page 6)  
 No Heat/Fluff (Model 5030/4030)

## CAUTION

Do Not overdry. Overdrying can cause shrinkage, static cling or can damage some fabrics.

**NOTE:** The drawings in this book may vary slightly from your dryer model. They are designed to show the different features of all the models covered by this book. Your model may not include all the features shown.

## B. Select a cycle and time

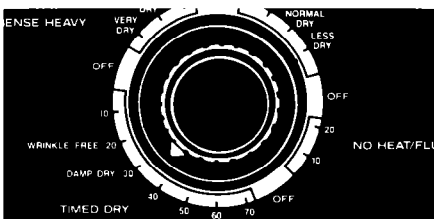

Turn cycle control knob either direction until the indicator on knob's outer ring points to cycle and setting you want.

## C. Select temperature

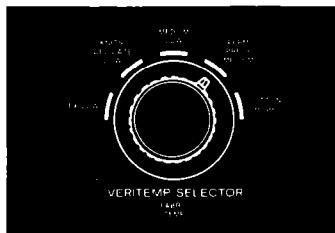

Turn temperature selector to the temperature setting you want.

## D. To start

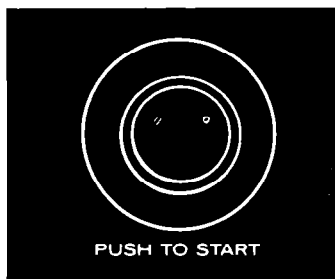

Push the start button.

## E. To stop the dryer at any time

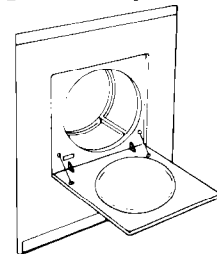

Open the door or turn the cycle control knob to OFF. To restart, close the door, select cycle (if necessary) and push start button.

## F. To change setting at any time

Turn cycle control knob and/or temperature selector to new setting.

The cycle control knob should point to OFF when the dryer is not in use. If the dryer is stopped before the cycle finishes, turn the cycle control knob to OFF.

# Model EL4030/GL4030

(Check behind dryer door for model number)

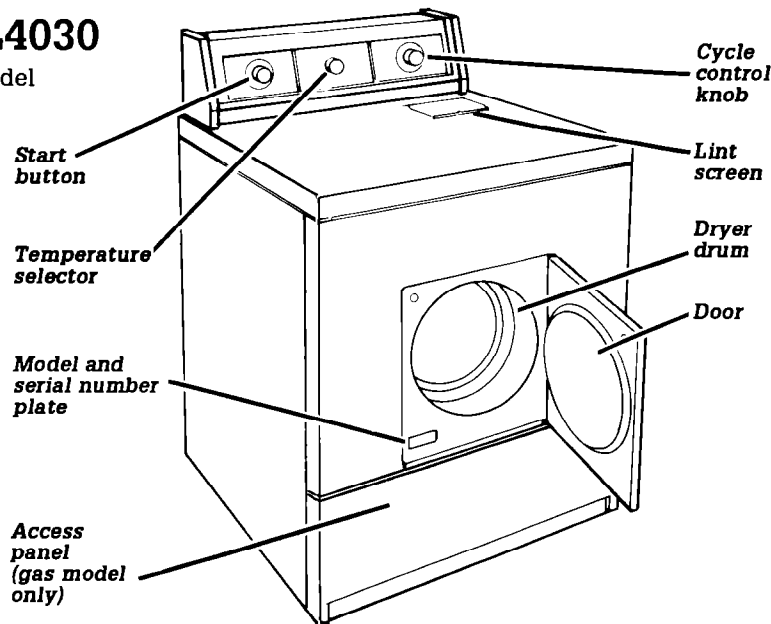

## Select cycle and setting

### A. Special Dry

Use this cycle to dry LIGHT, MEDIUM, HEAVY and EX HEAVY cottons and linens. See loading chart for suggested cycle settings. If the load is not as dry as you want after finishing the cycle, set cycle control knob more to the left the next time you dry that kind of load. If the load is too dry, set the cycle control knob more to the right the next time you dry that kind of load.

To operate, turn cycle control knob to the number of minutes you want. Push the start button. The last 10 minutes of this cycle are without heat to help make the load easier to handle and to reduce wrinkling.

### C. Damp Dry

Use this setting to dry damp items or to dry items to damp level (for example heavy cottons such as jeans which you do not want to become stiff or cotton clothes which are easier to press when damp.)

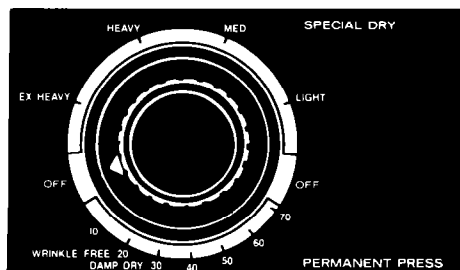
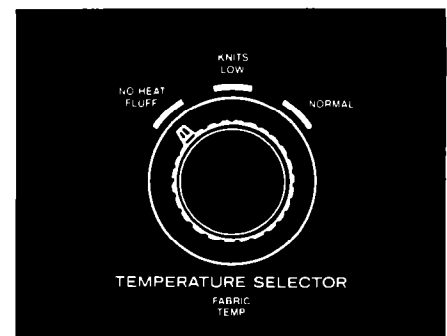

### B. Permanent Press

Use this cycle to dry permanent press, knits and delicate fabrics for a set time between 10 and 70 minutes. For example:

#### Permanent press

- Heavyweight — 40-50 minutes
- Mediumweight — 30-40 minutes
- Lightweight — 20-30 minutes

### D. Wrinkle Free

Use this cycle to remove wrinkles from clothing that has been packed in a suitcase, closet or not removed promptly from dryer. To operate, turn cycle control knob to WRINKLE FREE; set the temperature selector to KNITS/LOW and push the start button. The load will tumble in heated air for 10 minutes and without heat for 10 minutes more. For best results, put only a few items in the dryer and remove as soon as the dryer stops. Fold or hang on hangers immediately.

## Select temperature setting

### A. No Heat/Fluff

Use for rubber, plastic and heat-sensitive fabrics. (See chart on Page 3 for time settings.)

To operate, turn temperature selector to NO HEAT/FLUFF. Turn cycle control knob to the number of minutes you want.

Push the start button.

### B. Knits/Low

Use for medium/lightweight knits and delicate fabrics.

### C. Normal

Use for cotton, linen, permanent press and heavyweight knit fabrics.

# Models EL5030/GL5030

(Check behind dryer door for model number)

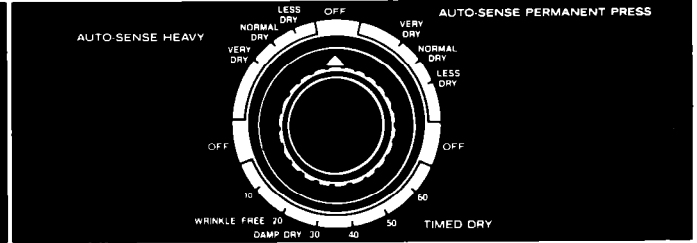
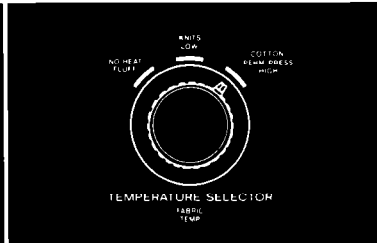
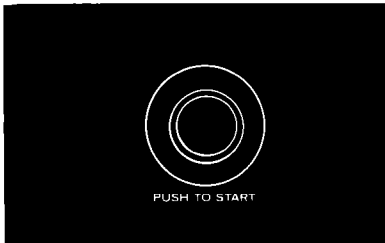
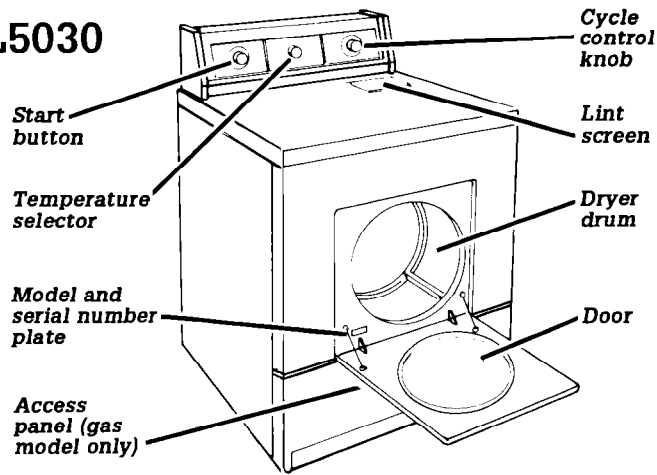

## Select cycle and setting

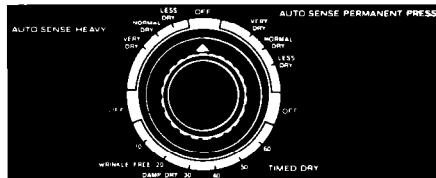

### A. Automatic Cycles

The automatic cycles let you select the degree of dryness you want. A thermostat senses the air temperature and automatically shuts the dryer off when the selected dryness is reached.

1. Use **Auto-Sense Heavy** to dry heavy and medium-weight cotton or linen items. The load tumbles without heat the last 5 minutes for easier load handling.

2. Use **Auto-Sense Permanent Press** to dry permanent press, knits and other synthetic items. The load tumbles without heat during the last 10 minutes to help prevent wrinkles and to make the load easier to handle.

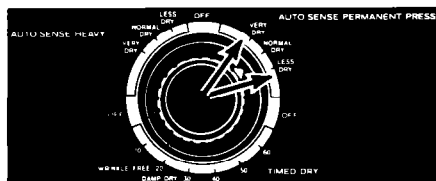

3. **Adjusting the dryness levels.** Set the cycle control knob to Normal Dry in the automatic cycle. When dryer stops, feel the items for dryness.

If items are drier than you like, set the control to the **right** of Normal Dry the next time you dry that kind of load. If the items are not as dry as you like, set the control to the **left** of Normal Dry the next time you dry that kind of load.

The cycle control knob will not move until the clothes load is almost dry, or the cool-down time of the cycle has been reached. After the cool-down cycle is finished, the cycle control knob automatically moves to OFF and the dryer stops tumbling.

### B. Timed Dry

Use this cycle for drying a load for a set time between 10 and 60 minutes. To operate, turn cycle control knob to the number of minutes you want. Push the start button. (The last 5 minutes of this cycle are without heat to help make the load easier to handle and to reduce wrinkling.)

**NOTE:** Overdrying can cause shrinkage, static cling and damage to some fabrics.

### C. Damp Dry

Use this setting to dry damp items or to dry items to damp level (for example heavy cottons such as jeans which you do not want to become stiff or cotton clothes which are easier to press when damp.)

### D. Wrinkle Free

Use this cycle to remove wrinkles from clothing that has been packed in a suitcase, closet or not removed promptly from dryer. To operate, turn cycle control knob to **WRINKLE FREE**; set the temperature selector knob to **NOTE:** Overdrying can cause shrinkage, static cling and damage to some fabrics.

**KNITS/LOW** and push the start button. The load will tumble in heated air for 15 minutes and without heat for 5 minutes more. For best results, put only a few items in the dryer and remove as soon as the dryer stops. Fold or hang on hangers immediately.

## Select temperature setting

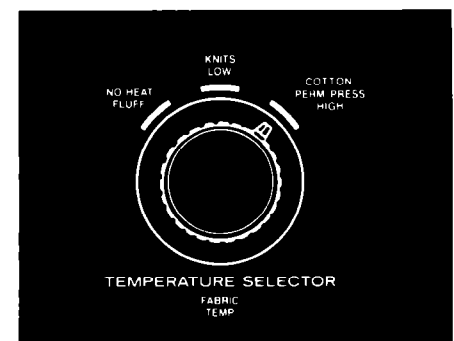

### A. No Heat/Fluff

Use for rubber, plastic and heat-sensitive fabrics. (See chart on Page 3 for time settings.)

To operate, turn temperature selector to **NO HEAT/FLUFF**. Turn cycle control knob to **TIMED DRYING** and set the number of minutes you want. Push the start button.

### B. Knits/Low

Use for medium/lightweight knits and delicate fabrics.

### C. Cotton/Perm Press High

Use for cotton, linen, permanent press and heavyweight knit fabrics.

# Models EL6050/GL6050

(Check behind dryer door for model number)

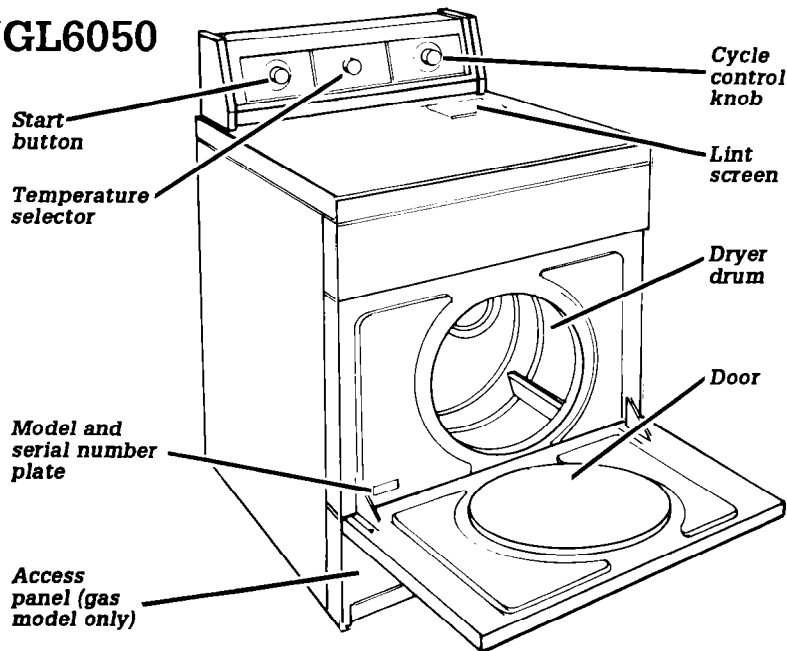

## Select cycle and setting

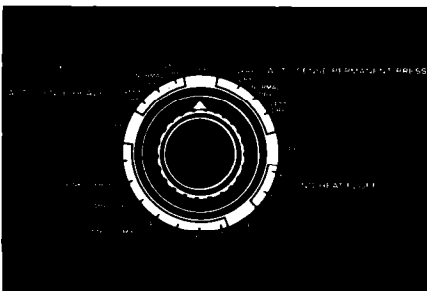

### A. Automatic Cycles

The automatic cycles let you select the degree of dryness you want. A thermostat senses the air temperature and automatically shuts the dryer off when the selected dryness is reached.

**1. Use Auto-Sense Heavy** to dry heavy and medium-weight cotton or linen items. The load tumbles without heat the last 5 minutes for easier load handling.

**2. Use Auto-Sense Permanent Press** to dry permanent press, knits and other synthetic items. The load tumbles without heat during the last 10 minutes to help prevent wrinkles and to make the load easier to handle.

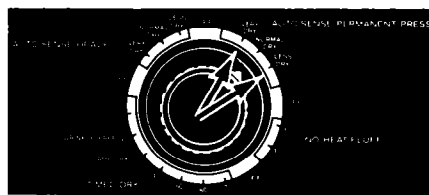

**3. Adjusting the dryness levels.** Set the cycle control knob to Normal Dry in the automatic cycle. When dryer stops, feel the items for dryness.

If items are drier than you like, set the control to the **right** of Normal Dry the next time you dry that kind of load.

If the items are not as dry as you like, set the control to the **left** of Normal Dry the next time to dry that kind of load.

The cycle control knob will not move until the clothes load is almost dry, or the cool-down time of the cycle has been reached. After the cool-down cycle is finished, the cycle control knob automatically moves to OFF and the dryer stops tumbling.

### B. No Heat/Fluff

Use for rubber, plastic and heat-sensitive fabrics. (See chart on Page 3 for time settings.)

To operate turn cycle control to number of minutes you want in the No Heat/Fluff cycle. Push the start button. Cycle may need to be reset for additional time.

**NOTE:** A temperature setting does not need to be selected in this cycle.

### C. Timed Dry

Use this cycle for drying a load for a set time between 10 and 70 minutes. To operate, turn cycle control knob to the number of minutes you want. Push the start button. (The last 5 minutes of this cycle are without heat to help make the load easier to handle and to reduce wrinkling.)

**NOTE:** Overdrying can cause shrinkage, static cling and damage to some fabrics.

### D. Damp Dry

Use this setting to dry damp items or to dry items to damp level (for example heavy cottons such as jeans which you do not want to become stiff or cotton clothes which are easier to press when damp).

### E. Wrinkle Free

Use this cycle to remove wrinkles from clothing that has been packed in a suitcase, closet or not removed promptly from dryer. To operate, turn cycle control knob to **WRINKLE FREE**; set the temperature selector knob to **KNITS/LOW** and push the start button. The load will tumble in heated air for 15 minutes and without heat for 5 minutes more. For best results, put only a few items in the dryer and remove as soon as the dryer stops. Fold or hang on hangers immediately.

## Models EL6050/ GL6050 continued

### Select temperature setting

(May be set on or between setting shown).

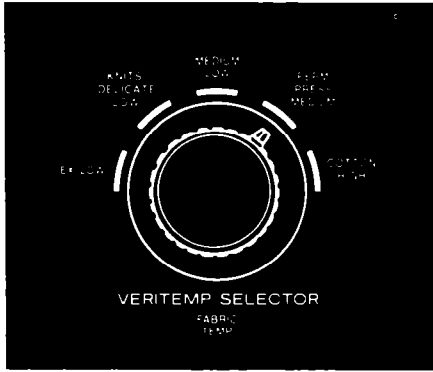

#### A. Ex Low

Use for lightweight and delicate fabrics such as sheer curtains, lace and gauze.

#### B. Knits/Delicate Low

Use for lightweight cottons and linens, delicate knits and synthetic fabrics.

#### C. Medium Low

Use for lightweight permanent press, heavyweight knits and synthetic fabrics.

#### D. Perm Press Medium

Use for heavyweight and mediumweight cottons and linens, permanent press and synthetic fabrics.

#### E. Cotton High

Use for heavyweight cottons and linens.

#### Gentle Heat

During the last few minutes of all heat cycles, the dryer temperature gradually reduces to a lower heat setting to help prevent overdrying.

#### End-of-Cycle Signal

A signal sounds when the cycle is finished. This signal cannot be shut off or adjusted.

The signal is helpful when drying permanent press, synthetic and other items that should be removed as soon as the dryer stops.

## Drying tips

### A. Load sizes

Do Not overload the dryer.

Mix larger items with smaller items.

Dry smaller loads of permanent press and synthetics and remove immediately after tumbling stops, to reduce wrinkling.

Add one or two, lint-free towels to loads with just a few small items. This allows for better tumbling action and prevents the small, lightweight items from blocking air flow.

Rearrange load during a cycle to prevent large items (sheets, tablecloths and blankets) from balling or rolling up.

### B. Dryer fabric softeners

Follow manufacturer's instructions.

Place fabric softener sheet on top of the load before starting the dryer.

Do Not add fabric softener sheet after cycle has started. Instant heat may cause the fabric softener to spot fabrics.

A clear, grease-like spot can result if a fabric softener sheet becomes tangled or wrapped in an item during tumbling.

To remove fabric softener stain, wet the stain and rub with liquid detergent or bar soap. Wash the item.

### C. Drying special items

Follow fabric care label instructions carefully for blankets, woolens, curtains, draperies, slip covers, diapers and baby clothes, elastic items, flame-retardant finishes, heat-sensitive fabrics, napped items (corduroy and velveteen) and permanent press fabrics.

#### Knitted woolens

Machine drying is not recommended. Block to shape when wet and allow to air-dry.

#### Cotton and canvas shoes

1. Place several bath towels in the dryer to act as a buffer.
2. If rubber or foam rubber materials are part of shoe, use No Heat/Fluff setting. For other materials see Page 3.
3. Remove when damp-dry and finish drying out of the dryer.

Service or performance problems caused by the use of any product not manufactured by Whirlpool Corporation are the responsibility of the manufacturer of that product.

## CAUTION

Some dryer fabric softeners can:

- deposit a greasy-looking residue on fabrics and inside the dryer.
- cause rust inside the dryer.
- clog the lint screen and slow down drying.
- cause dryers with dryness sensors to overheat and/or fail to shut off.

Use only fabric softeners specially labeled as not being harmful to the dryer.

## Common Laundering Problems

| Problem               | Check if  | What to do   |
|-----------------------|---|--|
| <b>Brown stains</b>   | Dryer fabric softeners were used.               | Follow manufacturer's product directions carefully.  |
|                       | Wet items were stored in washer or dryer.       | Do Not store wet items in washer or dryer. This can cause rusting.   |
| <b>Color transfer</b> | Dryer drum is clean.                            | Clean dryer drum thoroughly after drying tinted, dyed or non-colorfast items. (See Page 10.)   |
| <b>Greasy spots</b>   | Dryer fabric softeners were used.               | Follow manufacturer's product directions carefully.  |
|                       | Undiluted washer fabric softener was used.      | Dilute fabric softener before adding to deep rinse.  |
|                       | Enough detergent was used.                      | Use enough detergent to hold soil in the wash water until it drains away. Undrained soil can stick to outer tub of the washer and cause greasy spots with next load.   |
|                       | Items were clean before they were dried.        | Soiled items can stain other items in the load. They can also leave stains on the dryer drum that can be picked up by items in later loads. Dryer heat may permanently set these stains.   |
| <b>Lint</b>           | Lint screen is clogged.                         | Clean lint screen. (See Page 10.)  |
|                       | Load is properly sorted.                        | Sort lint-givers (bath towels, etc.) from lint-takers (synthetics, permanent press).   |
|                       | Static electricity is attracting lint.          | Use fabric softener in the washer's final, deep rinse. Use correct dryer settings for fabric. Overdrying synthetics can cause lint-attracting static electricity.  |
|                       | Load is too big or heavy.                       | Dry smaller loads. When items can't tumble freely, air is unable to carry lint to lint screen.   |
|                       | Paper or tissue was in pocket.                  | Empty pockets carefully. A small scrap of paper can cause a lot of lint.   |
|                       | Enough detergent was used.                      | Use enough detergent to hold the lint in the water until it drains away. Base detergent amount on water hardness and soil in wash load.  |
|                       | Pilling is being mistaken for lint.             | Pilling (surface fuzz) is caused by normal wear and laundering. Pills do not break away easily from the fabric and can often collect lint. Synthetic fabrics are more likely to pill than others, especially at neckbands, elbows and knees. |
| <b>Shrinking</b>      | Items are overdried.                            | Remove items while there is still a trace of moisture. Some items should be removed while damp, then shaped and air-dried. Use LESS DRY setting if your dryer has an automatic dryness control.  |
|                       | Fabric type and quality is suitable for drying. | Some knits are stretched during manufacturing. Washing and drying returns them to the original size. This is normal. Check quality of garment before buying. Follow fabric care label directions carefully.                                  |



---

## Common Laundering Problems, Continued

---

| <b>Problem</b>            | <b>Check if</b>  | <b>What to do</b>   |
|---------------------------|--|---|
| <b>Slow drying</b>        | There is a large amount of moisture in the load to be dried.         | Some items hold more moisture than others (cottons more than polyester). They take longer to dry. Full loads take longer to dry than small loads of the same fabric. Low washer-spin speeds (recommended for permanent press and knits) remove less moisture than high-spin speeds. |
|                           | Cold rinse water is used.  | A load rinsed in cold water will take slightly longer to dry than a warm one. Cold rinses, however, help save energy and reduce wrinkling more than warm rinses do.   |
|                           | Room air temperature is below 45°F or 7.2°C.                         | Install dryer in a room where the air temperature is warmer than 45°F or 7.2°C. Cold air increases drying time and may cause wrinkles not to be removed.  |
|                           | Dryer is exhausted according to Installation Instructions.           | Install and exhaust your dryer according to the Installation Instructions provided.   |
|                           | Lint screen is clogged.  | Clean lint screen before or after each use.   |
|                           | Proper electrical supply is used.                                    | Properly connect the dryer to a grounded electrical circuit that meets the electrical requirements stated in the Installation Instructions.   |
|                           | Modern dryer design is new to you.                                   | Your modern dryer is designed for the care of modern fabrics. Drying temperatures are lower than in older models. The cool-down time at the end of each drying cycle helps reduce wrinkling and makes clothes easier to handle, but it may take longer to dry than you are used to. |
| <b>Static electricity</b> | Load is overdried.   | Remove items while there is still a trace of moisture. Use a "less dry" setting if your dryer has an automatic dryness sensor.  |
|                           | Fabric softener was used.  | Follow manufacturer's product directions carefully.   |
|                           | Synthetics, synthetic blends, permanent press and knits are in load. | Synthetics, synthetic blends, permanent press and knits build up static electricity. Use a fabric softener and be careful not to overdry the load.  |

---

## Caring for your dryer

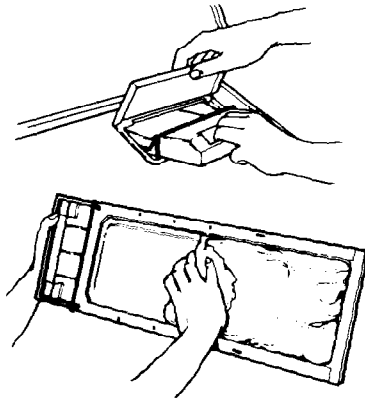

### A. Cleaning the lint screen

Open the lid and pull the lint screen straight out. Roll the lint off the screen with your fingers. Do Not rinse or wash the screen. Push the screen firmly back into place.

## ⚠ WARNING

### Fire Hazard

- Clean the lint screen before or after each load. A screen blocked by lint can increase drying time and can cause a fire.
- Do Not run the dryer with the lint screen loose, damaged, blocked or missing. This can cause overheating, damage to fabrics and a fire.

### B. Cleaning lint from inside dryer cabinet

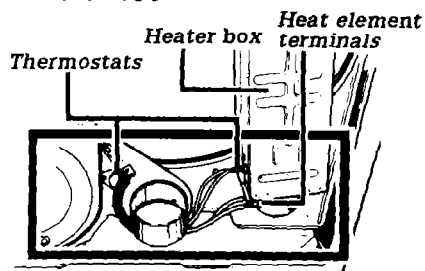

Electric Dryers

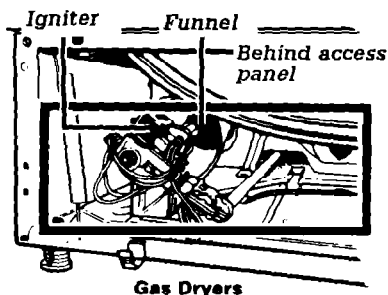

Gas Dryers

Lint can gather inside the dryer and cause a fire. Remove lint at least every 2 to 3 years, or more often, depending on dryer usage.

## ⚠ WARNING

### Electrical Shock Hazard

- Unplug power supply cord or shut off electrical power supply before removing lint.
- Do Not put hands inside dryer cabinet.
- Make sure the dryer is cool. Failure to do so could result in electrical shock, injury or damage.

### Fire Hazard

- Shut off gas valves on gas dryers. Failure to do so could result in gas leak or explosion.

Cleaning should be done only by a qualified person.

1. Remove back panel (electric) or lower access panel (gas).
2. Remove lint from boxed-in area with a soft brush or vacuum cleaner.
3. Avoid damaging wires, thermostats, funnel or igniter.
4. Replace panel; reconnect and re-level dryer.

### C. Cleaning the dryer interior

## ⚠ WARNING

### Electrical Shock Hazard

- Unplug power supply cord or shut off electrical power supply before cleaning interior. Failure to do so could result in electrical shock or injury.

### Fire Hazard

- Shut off gas valves on gas dryers.
- Use nonflammable cleaner. Failure to do so could result in gas leak or explosion.

If the interior is discolored from fabrics containing unstable dyes (blue denim jeans or brightly colored cottons) clean with one of the following methods to avoid staining later load items:

#### 1. Powdered laundry detergent

Make a paste with detergent and very warm water. Apply paste to a soft, clean cloth and scrub area until all excess dye is removed. Wipe thoroughly with a damp cloth. To dry, tumble a load of clean rags.

#### 2. Nonflammable liquid household cleaner

Apply to stained area. Rub with a soft, clean cloth until all excess dye is removed. To dry, tumble a load of clean rags.

### D. Cleaning the cabinet exterior

Wipe off all spills with a damp, soft cloth. Spills allowed to remain may dull or damage the finish.

## ⚠ CAUTION

- Do Not put sharp or heavy objects on or in the dryer. These objects may damage the dryer. Check pockets for bolts, nuts, etc.

### E. Before you go on vacation

Clean lint screen.

For electric dryer — unplug the power cord or shut off the electrical power supply.

For gas dryer — close gas valve.

## Before you call for service

If you are having an operating problem, check this chart to see what might be the cause before you call for assistance.

| <b>Problem</b>               | <b>Check if</b>  | <b>What to do</b>   |
|------------------------------|--|---|
| <b>Dryer will not run.</b>   | Power cord is plugged into a live circuit with proper voltage.   | Turn cycle control knob to OFF. Firmly plug cord into electrical outlet. Check circuit voltage at fuse/circuit breaker box. Reset controls and push start button.   |
|                              | Dryer door is closed.  | Close door firmly.  |
|                              | Start button is pushed firmly.   | Push start button.  |
|                              | Controls are set in a running or ON position.  | Set controls and push start button.   |
|                              | Home's main fuse has blown or circuit breaker has tripped. Also check if a time-delayed fuse or circuit breaker has been used. | Turn cycle control knob to OFF. Replace fuse with a time-delay fuse of the correct capacity. Reset circuit breaker. Reset controls and push start button.   |
| <b>Dryer will not heat.</b>  | Gas shutoff valves are open both on dryer and on supply line.  | Turn cycle control knob to OFF. Open gas valve. Wait 5 minutes. Reset controls and push start button.   |
|                              | Cycle control knob or temperature selector is set on NO HEAT/FLUFF.  | Reset cycle control knob or temperature selector to heat setting.   |
|                              | Heat cycle is in its last minutes. (There is no heat during that time.)  | Wait for cycle to finish.   |
|                              | Home's main fuse has blown or circuit breaker has tripped. Also check if a time-delayed fuse or circuit breaker has been used. | Turn cycle control knob to OFF. Replace fuse with a time-delay fuse of the correct capacity. Reset circuit breaker. Reset controls and push start button.<br><br>An electric dryer circuit uses 2 breakers or 2 fuses. If one breaker has tripped or one fuse has blown, the dryer may run, but not heat. |
| <b>Drying time too long.</b> | Gas shutoff valves are open both on dryer and on supply line.  | Turn cycle control knob to OFF. Open gas valves. Wait 5 minutes. Reset controls and push start button.  |
|                              | Lint screen clean.   | Clean lint screen. See instructions on Page 10.   |

# LIMITED WARRANTY



## Appliances

| LENGTH OF WARRANTY<br>(From date of purchase) | PRODUCTS COVERED                              | WHAT WE WILL PAY FOR  |
|---|---|---|
| <b>FULL ONE YEAR WARRANTY</b>                 | All Roper Appliances                          | Replacement parts and repair labor to correct defects in materials or workmanship.  |
| <b>FULL FIVE YEAR WARRANTY</b>                | Refrigerators<br>Freezers<br>Air Conditioners | Replacement parts and repair labor for the sealed refrigeration system (compressor, evaporator, condenser, drier or connecting tubing) which we find to be defective in materials or workmanship. |
| <b>LIMITED 2ND-5TH YEAR WARRANTY</b>          | Microwave Ovens                               | Repair or replacement of magnetron tube which we find to be defective in materials or workmanship.  |
| <b>LIMITED 2ND-5TH YEAR WARRANTY</b>          | Automatic Washers                             | Repair or replacement of any part of the gear case assembly which we find to be defective in materials or workmanship.  |

### WHAT WE WILL NOT PAY FOR

#### A. SERVICE CALLS TO:

1. Correct the installation of your appliance.
2. Instruct you how to use your appliance.
3. Replace house fuses or correct house wiring or plumbing.
4. Replace owner accessible light bulbs.

B. Repairs when appliance is used in other than normal, single-family household use.

C. Pick up and delivery. Your appliance is designed to be repaired in the home.

D. Damage to appliance caused by accident, misuse, fire, flood, acts of God, or use of product not approved by us.

E. Any labor costs during the limited warranties.

This Roper appliance is warranted by Whirlpool Corporation. Under no circumstances shall it be liable under this warranty for incidental or consequential damages and all implied warranties are limited to the same time periods stated in the express warranties for Roper Brand Appliances. Some states do not allow the exclusion or limitation of incidental or consequential damages or limitations of how long an implied warranty may last, so the above limitations or exclusions may not apply to you.

This warranty gives you specific legal rights, and you may also have other rights which vary from state to state.

Outside the United States, a different warranty may apply. For details, please contact your franchised Roper distributor or military exchange.

### HOW TO GET SERVICE OR ASSISTANCE

If you need service, first see the "Before You Call For Service" section of this book. If you still need service after checking this section, additional help can be found if you:

▪ Contact your selling dealer for the authorized servicer in your area\*

OR

▪ Phone 1-800-44-ROPER (1-800-447-6737) between 8:00 a.m. and 4:30 p.m. Eastern Time, Monday through Friday\*

OR

▪ For further information, write to: Consumer Relations Dept., Roper Brand Appliances, 2000 M-63 North, Benton Harbor, MI 49022\*

\*When requesting assistance, please provide the model and serial numbers, date of purchase, and a complete description of the problem. The model and serial numbers are located behind the dryer door. (See illustration for your model on pages 4, 5 or 6.)

If you are not satisfied with the service received, contact the Major Appliance Consumer Action Panel (MACAP). MACAP is a group of independent consumer experts that voices consumer views at the highest levels of the major appliance industry.

Contact MACAP only when the dealer, authorized servicer or Roper Brand Appliance warrantor have failed to resolve your problem.

Major Appliance Consumer Action Panel  
20 North Wacker Drive  
Chicago, IL 60606

MACAP will in turn inform us of your action.

## Free Manuals Download Website

<http://myh66.com>

<http://usermanuals.us>

<http://www.somanuals.com>

<http://www.4manuals.cc>

<http://www.manual-lib.com>

<http://www.404manual.com>

<http://www.luxmanual.com>

<http://aubethermostatmanual.com>

Golf course search by state

<http://golfingnear.com>

Email search by domain

<http://emailbydomain.com>

Auto manuals search

<http://auto.somanuals.com>

TV manuals search

<http://tv.somanuals.com>