

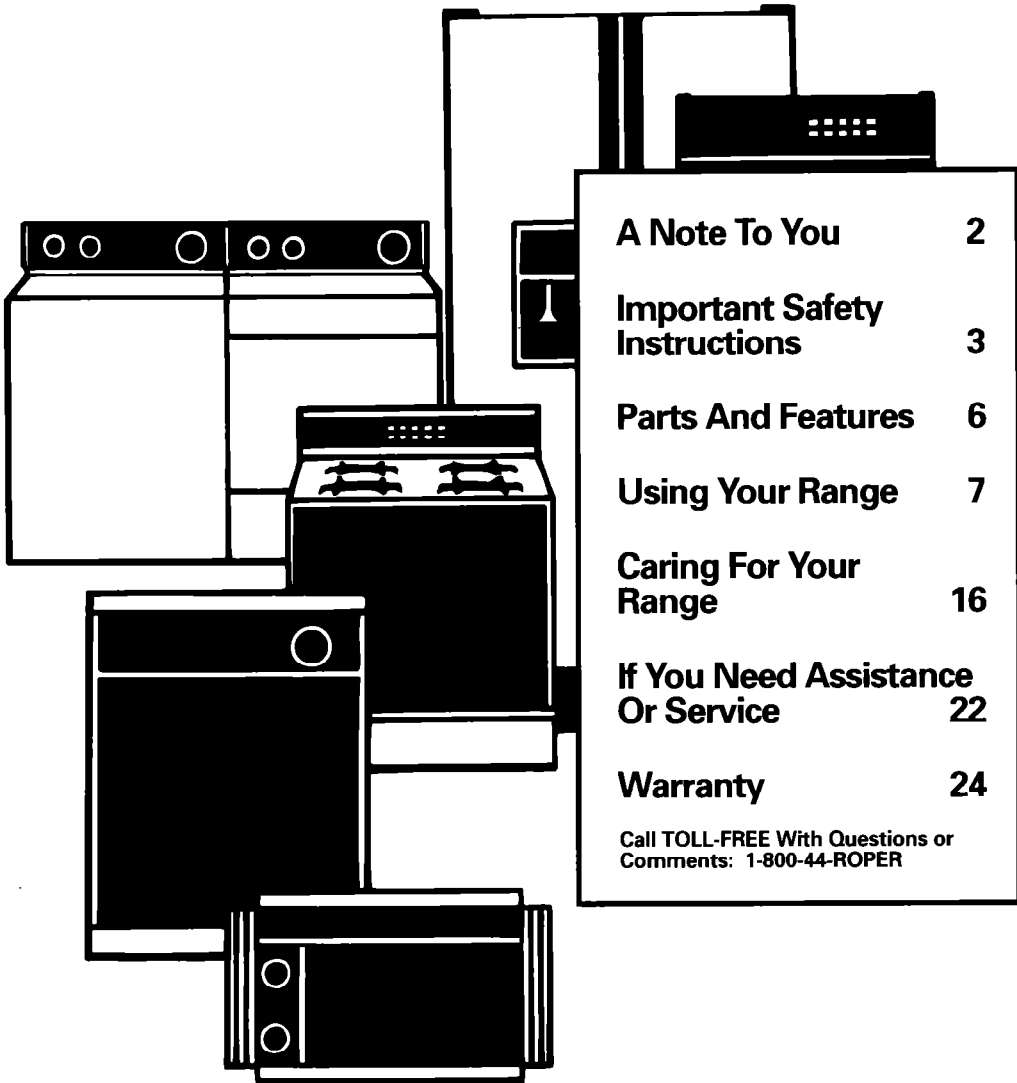

Home Appliances

# Use And Care

## G U I D E



### STANDARD-CLEANING GAS RANGES

TO THE INSTALLER: PLEASE LEAVE THIS INSTRUCTION BOOK WITH THE UNIT.

TO THE CONSUMER: PLEASE READ AND KEEP THIS BOOK FOR FUTURE REFERENCE.

MODELS FGP325Y FGP320Y  
FLP320Y FGP315Y  
FGP310Y FLP310Y

# A Note To You

## Thank you for buying a Roper appliance.

You have purchased a quality, *world-class* home appliance. Years of engineering experience have gone into its manufacturing. To ensure that you will enjoy many years of trouble-free operation, we have developed this Use and Care Guide. It is full of valuable information on how to operate and maintain your appliance properly and safely. Please read it carefully. Also, please complete and mail the Ownership Registration Card provided with your appliance. This will help us notify you about any new information on your appliance.

## Your safety is important to us.

This guide contains safety symbols and statements. Please pay special attention to these symbols and follow any instructions given. Here is a brief explanation of the use of each symbol.

### **WARNING**

This symbol will help alert you to such dangers as personal injury, burns, fire and electrical shock.

### **CAUTION**

This symbol will help you avoid actions which could cause product damage (scratches, dents, etc.) and damage to your personal property.

## Our TOLL-FREE number, 1-800-44-ROPER (1-800-447-6737), is available 24 hours a day.

If you ever have a question concerning your appliance's operation, or if you need service, first see "If You Need Assistance Or Service" on page 22. If you need further help, feel free to call our Consumer Assistance Center. When calling, you will need to know your appliance's complete model number and serial number. You can find this information on the model and serial number plate (see diagram on page 6). For your convenience, we have included a handy place below for you to record these numbers, the purchase date from the sales slip and your dealer's name and telephone number. Keep this book and the sales slip together in a safe place for future reference.

**Model Number** \_\_\_\_\_

**Dealer Name** \_\_\_\_\_

**Serial Number** \_\_\_\_\_

**Dealer Phone** \_\_\_\_\_

**Purchase Date** \_\_\_\_\_

# Important Safety Instructions

Gas ranges have been thoroughly tested for safe and efficient operation. However, as with any appliance, there are specific installation and safety precautions which must be followed to ensure safe and satisfactory operation.

## **⚠ WARNING**

To reduce the risk of fire, electrical shock, injury to persons, or damage when using the range, follow basic precautions, including the following:

**WARNING:** If the information in this manual is not followed exactly, a fire or explosion may result causing property damage, personal injury or death.

**DO NOT STORE OR USE GASOLINE OR OTHER FLAMMABLE VAPORS AND LIQUIDS IN THE VICINITY OF THIS OR ANY OTHER APPLIANCE.**

### **WHAT TO DO IF YOU SMELL GAS:**

- **DO NOT TRY TO LIGHT ANY APPLIANCE.**
- **DO NOT TOUCH ANY ELECTRICAL SWITCH; DO NOT USE ANY PHONE IN YOUR BUILDING.**
- **IMMEDIATELY CALL YOUR GAS SUPPLIER FROM A NEIGHBOR'S PHONE. FOLLOW THE GAS SUPPLIER'S INSTRUCTIONS.**
- **IF YOU CANNOT REACH YOUR GAS SUPPLIER, CALL THE FIRE DEPARTMENT.**

**INSTALLATION AND SERVICE MUST BE PERFORMED BY A QUALIFIED INSTALLER, SERVICE AGENCY OR THE GAS SUPPLIER.**

### **General**

- Install or locate the range only in accordance with the provided Installation Instructions. The range must be installed by a qualified installer. The range must be properly connected to the proper gas supply and checked for leaks. The range must also be properly connected to electrical supply and grounded.
- Gas fuels and their use in appliances can cause minor exposures to benzene, formaldehyde, carbon monoxide and soot, primarily from incomplete combustion. Significant exposure to these substances can cause cancer or reproductive harm. Properly adjusted burners with a blue, rather than a yellow, flame will minimize incomplete combustion. Venting with a hood or an open window will further minimize exposure.

continued on next page

# IMPORTANT SAFETY INSTRUCTIONS



- **WARNING:** To reduce the risk of tipping of the appliance, the appliance must be secured by a properly installed anti-tip bracket. To check if the bracket is installed properly, see "The anti-tip bracket" on page 15.
- Do not store things children might want above the range. Children could be burned or injured while climbing on it.
- Do not leave children alone or unattended in area where the range is in use. They should never be allowed to sit or stand on any part of the range. They could be burned or injured.
- Do not operate the range if it is damaged or not working properly.
- Do not use the range for warming or heating the room. Persons could be burned or injured, or a fire could start.
- Do not attempt to light the oven burner on electric ignition models during a power failure. Personal injury could result. Reset oven controls to the off position in the event of a power failure.
- Use the range only for its intended use as described in this manual.



- **DO NOT TOUCH SURFACE BURNERS, AREAS NEAR SURFACE BURNERS OR INTERIOR SURFACES OF OVEN.** Areas near surface burners and interior surfaces of an oven become hot enough to cause burns. During and after use, do not touch, or let clothing or other flammable materials contact surface burners, areas near surface burners or interior surfaces of oven until they have

had sufficient time to cool. Other surfaces of the range may become hot enough to cause burns; such as, the oven vent opening, the surface near the vent opening, the cooktop and the oven door.



- Do not wear loose or hanging garments when using the range. They could ignite if they touch a hot surface burner and you could be burned.
- Use only dry potholders. Moist or damp potholders on surface burners may result in burns from steam. Do not let potholder touch surface burners. Do not use a towel or bulky cloth for a potholder. It could catch on fire.
- Keep range vents unobstructed.
- Do not heat unopened containers. They could explode. The hot contents could cause burns and container particles could cause injury.
- Do not store flammable materials on or near the range. The fumes can create an explosion and/or fire hazard.
- Do not use the oven for storage.
- Never use a match or other flame to look for a gas leak. Explosion and injury could result.
- Know where your main gas shutoff valve is located.

## When using the cooktop

- Make sure the utensils you use are large enough to contain food and avoid boilovers and spillovers. Heavy splattering or spillovers left on a range can ignite and burn you. Pan size is especially important in deep fat frying.
- Check to be sure glass cooking utensils are safe for use on the range. Only certain types of glass, glass-ceramic, ceramic, earthenware or other glazed utensils are suitable for cooktops without breaking due to the sudden change in temperature.

- Never leave surface burners unattended at high heat settings. A boilover could result and cause smoking and greasy spillovers that may ignite.



- Turn pan handles inward, but not over other surface burners. This will help reduce the chance of burns, igniting of flammable materials, and spills due to bumping of the pan.
- Do not use decorative covers or trivets over the surface burners.

## When using the oven

- Always position the oven rack(s) in desired location while oven is cool.
- Use care when opening oven door. Let hot air or steam escape before removing or replacing food.

## Grease

- Grease is flammable. Do not allow grease to collect around cooktop or in vents. Wipe spillovers immediately.



- Do not use water on grease fires. Never pick up a flaming pan. Smother flaming pan by covering with a well-fitted lid, cookie sheet or flat tray. Flaming grease outside of pan can be extinguished with baking soda or, if available, a multipurpose dry chemical or foam-type extinguisher.

## Care and cleaning

- Do not clean door heat seal. It is essential for a good seal. Care should be taken not to rub, damage or move the seal. Clean only parts recommended in this Use and Care Guide.
- Do not repair or replace any part of the range unless specifically recommended in this manual. All other servicing should be referred to a qualified technician.
- On some models, disconnect the electrical supply before servicing the range.

– SAVE THESE INSTRUCTIONS –

# Parts And Features

This section contains captioned illustrations of your range. Use them to become familiar with the location and appearance of all parts and features.

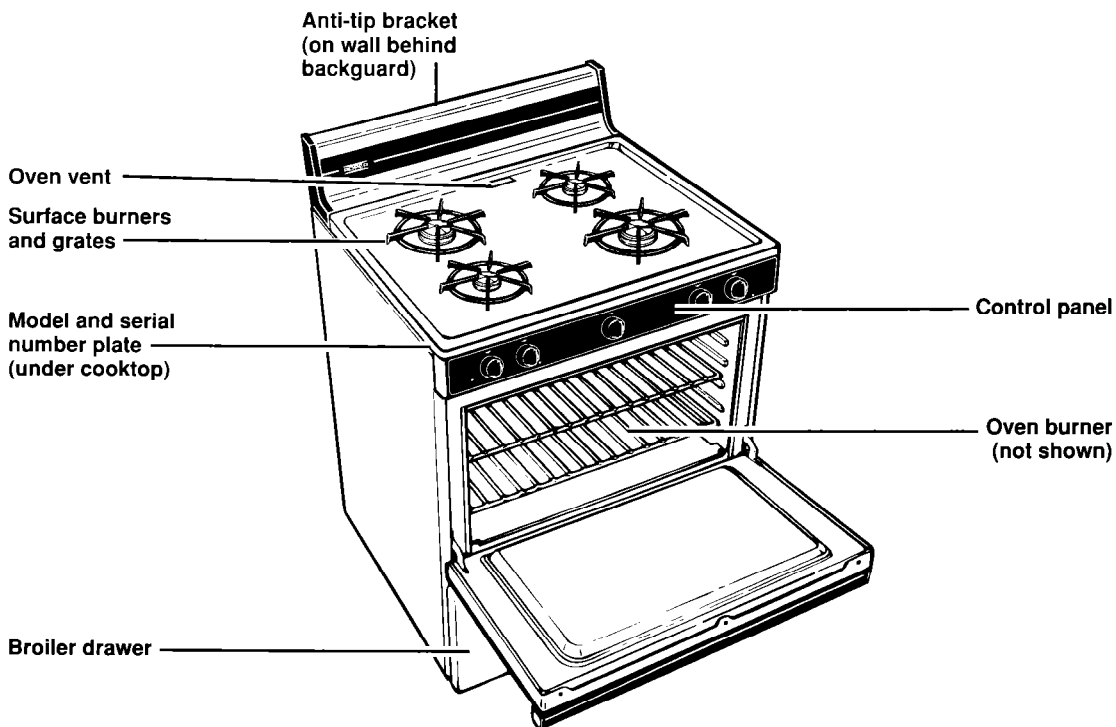

## Control panel

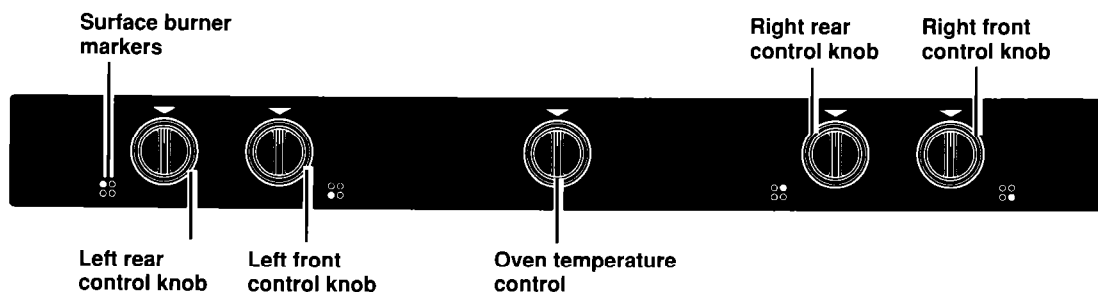

# Using Your Range

In This Section		Page	Page
Using the surface burners .....	7	Adjusting the oven temperature control .....	13
Positioning racks and pans .....	9	Broiling .....	13
For best air circulation .....	10	Energy saving tips .....	14
Lighting standing pilots .....	11	The oven vent .....	14
Baking/roasting .....	12	The anti-tip bracket .....	15

To obtain the best cooking results possible, you must operate your range properly. This section gives you important information for efficient and safe use of your range.

## Using the surface burners

Your range is equipped with either standing pilots or electric ignitors. Standing pilots must be lit initially with a match following the directions on page 11. The pilot light will remain lit when the burners are turned off. To turn a burner on again, just push in and turn the control knob to LITE and the burner will light. Electric ignitors automatically light the burners each time the control knob is turned to LITE.

**Control knobs must be pushed in** and turned to the LITE position. On electric ignitor models, the clicking sound is the ignitor sparking.

After the burner lights, turn the control knob to the desired setting. The control knob can be set anywhere between HI and LO.

### Surface burner markers

The solid dot in the surface burner marker shows which surface burner is turned on by that knob.

### Burner heat settings

Use correct burner heat settings (see next page). If the heat setting is too high, it can:

- Char bacon and cause curling.
- Make eggs tough and crisp at the edges.
- Toughen liver, fish and seafood.
- Scorch delicate sauces and custards.
- Cause a boilover.

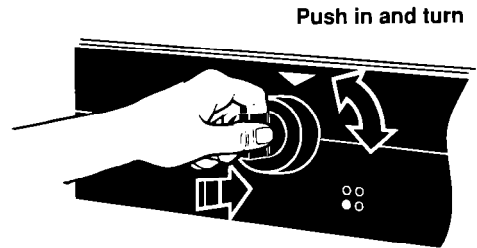

Until you get used to the settings, use the following as a guide. For best results, start cooking at the high settings; then turn the control knob down to continue cooking.

SETTING	RECOMMENDED USE
LITE	<ul style="list-style-type: none"> <li>To light the burner. After the burner lights, turn control back to a desired setting.</li> </ul>
HI	<ul style="list-style-type: none"> <li>To start foods cooking.</li> <li>To bring liquids to a boil.</li> </ul>
Medium	<ul style="list-style-type: none"> <li>To hold a rapid boil.</li> <li>To fry chicken or pancakes.</li> <li>For gravy, pudding and icing.</li> <li>To cook large amounts of vegetables.</li> </ul>
LO	<ul style="list-style-type: none"> <li>To keep food warm until ready to serve.</li> </ul>

**NOTE:** Do not cook with the control in the LITE position.

## In case of a prolonged power failure

Surface burners with electric ignitors can be manually lighted. Hold a lit match near a burner and slowly turn the control knob on until the burner lights. After the burner lights, turn the control knob to the desired setting. Power failures will not affect standing pilots.

## ⚠ WARNING

### Burn, Fire and Explosion Hazard

- Burner flame should not extend beyond the edge of the cooking utensil. The flame can burn you and cause poor cooking results.
- Be sure all control knobs are turned to OFF when you are not cooking. Someone could be burned or a fire could start if a burner is accidentally left ON.
- If the flame should go out while cooking, or if there is a strong gas odor, turn the burners OFF. Wait five minutes for the gas odor to disappear before relighting burner. If gas odor is still present, see safety note on page 3. Failure to follow these precautions could result in explosion or fire.

## Cookware tips

There is no one brand of cooking utensil that is best for all people. Knowing something about pan materials and construction will help you select the right cooking utensils for your needs.

- For best results and greater fuel efficiency, use flat-bottomed utensils.
- **NOTE:** Woks, canners and teakettles with flat bottoms suitable for use on your cooktop are now available in most houseware stores or departments.
- The pan should have straight sides and a tight-fitting lid.
- Choose medium to heavy gauge (thickness) pans that are fairly lightweight. Remember that a very heavy pan will be even heavier when filled with food.
- The pan material (metal or glass) affects how fast heat transfers from the surface burners through the pan material and how evenly heat spreads over the pan bottom. Choose pans that provide the best cooking results.
- Handles should be made of a sturdy, heat-resistant material and be securely attached to the pan.
- Pans should be easy to clean. Check to be sure there are no crevices, rough edges or areas where food might collect.
- Be sure pans do not tip, whether they are full or empty.
- Do not leave an empty utensil, or one which has boiled dry, on a hot surface burner. It can overheat and may damage the utensil or cooking product.
- Use utensils only as they were intended to be used. Follow pan instructions. This is very important for glass cookware because some should be used only in the oven. Other pans are marked as flameware and may be used on the surface burners.



## Home canning information

The larger diameter of most water-bath or pressure canners combined with high heat settings for long periods of time can cause damage to the cooktop.

### To protect your range:

- For best results, use a canner which can be centered over the surface burner.
- Do not place canner on two surface burners at the same time. Excessive heat build-up will damage the cooktop.
- Start with hot water. This reduces the time the control is set on high. Reduce heat setting to lowest position needed to keep water boiling.

## Positioning racks and pans

For baking/roasting with one rack, the rack should be placed so the top of the food will be centered in the oven. Always leave at least 1½ to 2 inches (4-5 cm) between the sides of the pan and the oven walls and other pans.

### For proper cooking, follow these guidelines for specific foods:

- Angel and bundt cakes, yeast breads, frozen pies, large roasts and turkeys—place rack on lowest level.
- Casseroles, muffins, most quick breads and meats—place rack on second or third level from bottom.
- Cookies, biscuits, cakes and non-frozen pies—place rack on second or third level from bottom.

When baking on two racks, arrange racks on bottom and third level from bottom.

**NOTE:** For recommended rack placement when broiling, see a reliable cookbook.

## **▲ WARNING**

### **Personal Injury Hazard**

- Always position oven rack(s) in desired location before turning oven on. Be sure the rack(s) is level.
- If rack(s) must be moved while oven is hot, use potholders or oven mitts to protect hands.

Failure to follow the above precautions may result in personal injury.

### For best air circulation

Hot air must circulate around the pans in the oven for even heat to reach all parts of the oven. This results in better baking.

- Place the pans so that one is not directly over the other.
- Allow 1½-2 inches (4-5 cm) of space around each pan and between pans and oven walls.
- Use only one cookie sheet in the oven at one time.

Use the following as a guide to determine where to place the pans.

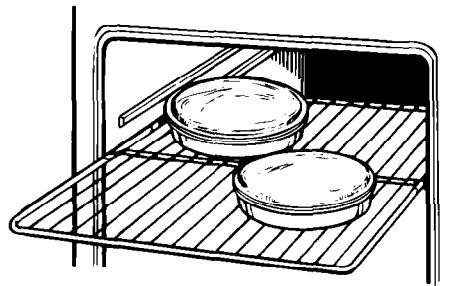

#### **One pan**

Place in the center of the oven rack.

#### **Two pans**

Place in opposite corners of the oven rack.

#### **Three or four pans**

Place in opposite corners on each oven rack.

Stagger pans so no pan is directly over another.

**NOTE:** "Oven peeking" may cause heat loss, longer cooking times and unsatisfactory baking or roasting results. Use a reliable kitchen timer to keep track of the cooking time.

## Lighting standing pilots (models FGP320Y, FLP320Y, FGP310Y and FLP310Y)

### To light range pilots:

1. Make sure all controls are turned off.
2. Remove the surface burner grates from the cooktop. Lift the cooktop. (See "Lift-up cooktop" on page 17.)

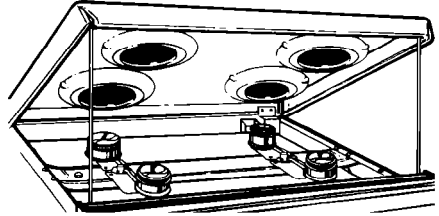

3. **To light**, hold a lit match over the pilot light located between the front and back burners. The pilot flame should be  $\frac{1}{4}$  to  $\frac{3}{8}$  in (.6-1 cm) high.

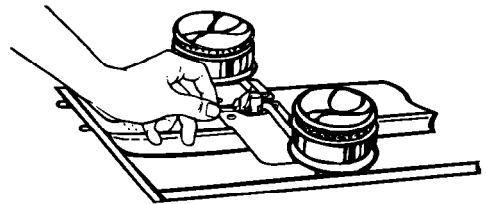

4. If the pilot flame needs adjustment, turn the pilot adjustment screw midway down the length of the manifold pipe, behind the control panel.
5. Lower the cooktop and replace the grates before using the surface burners.

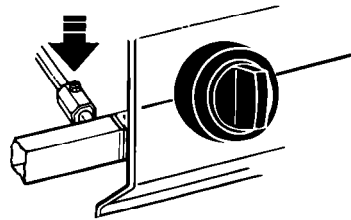

### To light oven burner pilot:

1. Make sure the Oven Temperature Control is turned off.
2. Remove the oven bottom (see "Removing the oven bottom" on page 19). Then unscrew the burner baffle located on the burner (see Installation Instructions for more information about the baffle).
3. Hold a lit match over the oven burner pilot located at the rear of the burner.
4. After the oven burner pilot is burning steadily, check burner lighting by turning the Oven Temperature Control to a temperature above 140°F (60°C). The burner will take 50-60 seconds to light.
5. Replace the burner baffle and oven bottom.

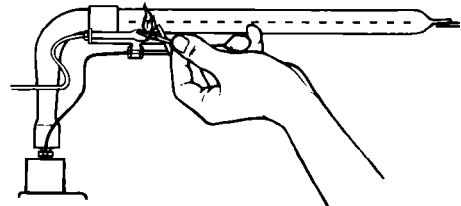

## Baking/roasting

1. Position the rack(s) properly **before** turning on the oven. **To change rack position**, lift rack at front and pull out. For further information, see "Positioning racks and pans" on page 9.
2. Push in and turn the Oven Temperature Control to the baking/roasting temperature you want. The oven burner will automatically light in 50-60 seconds.
3. When baking, preheat the oven for 10 minutes. Put food in the oven.  
**NOTE:** Do not preheat when roasting or cooking items such as casseroles.  
Do not place food directly on the oven bottom.
4. During baking/roasting, the oven burner will turn on and off to maintain the temperature setting.

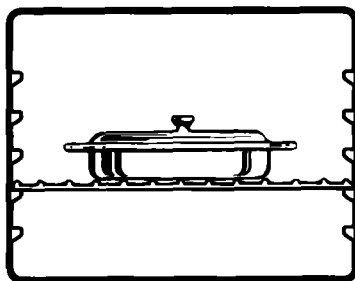
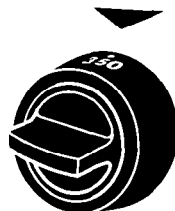

5. When baking/roasting is done, turn the Oven Temperature Control to OFF.

## Adjusting the oven temperature control

Does your oven seem hotter or colder than your old oven? The temperature of your old oven may have shifted gradually without you noticing the change. Your new oven is properly adjusted to provide accurate temperatures. But, when compared to your old oven, the new design may give you different results.

If, after using the oven for a period of time, you are not satisfied with the temperature settings, they can be adjusted by following these steps:

1. Push in and turn the Oven Temperature Control Knob to the off position. Pull knob straight off and flip it over.
2. Loosen the locking screws inside the control knob. **Note the position of the notches.**
3. **To lower the temperature**, hold knob handle firmly and move the tooth a notch clockwise. Each notch equals about 10°F (5°C).
4. **To raise the temperature**, hold knob handle firmly and move the tooth a notch counter-clockwise. Each notch equals about 10°F (5°C).

**Tighten the locking screws and replace the control knob.**

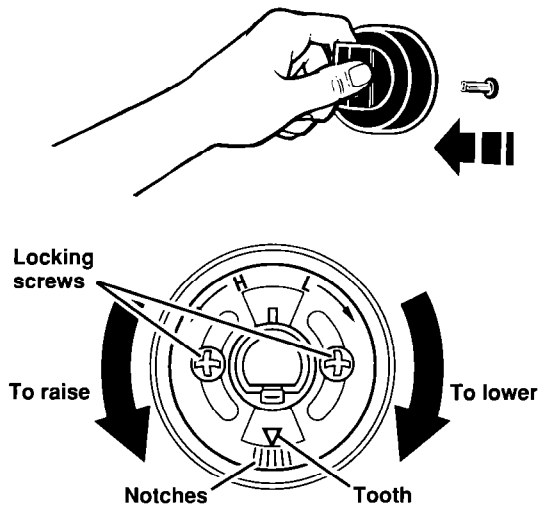

## Broiling

The broiler drawer is located below the oven door. **Always broil with the oven door closed.**

1. Pull the broiler drawer open and tilt the door panel down.
2. Place broiler pan grid so grease can drain down ribbing and through slots into lower part of the broiler pan. See picture.
3. Before the broiler is turned on, place food on broiler pan and position the broiler pan at one of the three levels. Refer to a reliable cook-book for broiling chart.

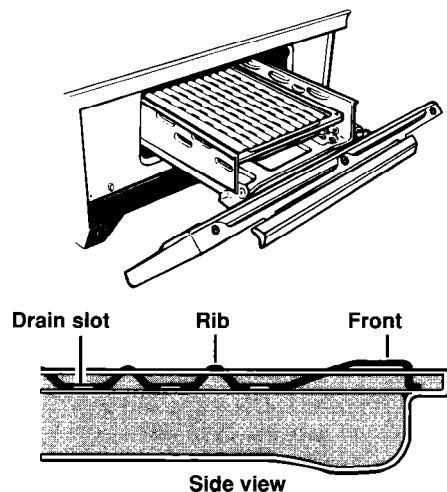

4. Push in and turn the Oven Temperature Control to BROIL. The broiler will automatically light in 50-60 seconds.



5. When broiling is done, turn the Oven Temperature Control to OFF.

**NOTE:** Do not preheat the broiler before using. Completely close the broiler drawer during broiling.

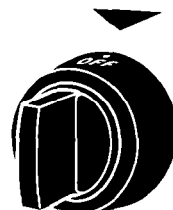

## Energy saving tips

Although the energy used for cooking is usually a very small percentage of the total energy used in the home, cooking energy can be used efficiently. Here are some tips to help you conserve energy when using your cooking product.

- Use pans with flat bottoms, straight sides and tight-fitting lids.
- Cook with a minimum of liquid or fat to help shorten cooking time.
- Preheat pans only when recommended and for the shortest time possible.
- Start food on higher heat settings, then set surface burner control on low or off to finish cooking. Use retained heat for cooking when possible.
- Use the more efficient surface burners instead of the oven when possible.
- Turn on the surface burner only after placing filled pan on the burner grate.
- "Oven peeking" may cause heat loss, longer cooking times and unsatisfactory baking results. Rely on your timer.
- Bake cakes, pies or cookies when oven is warm. Best time is after a meal has been cooked in it.
- Preheat the oven no longer than necessary.
- Plan your meals for the most efficient use of the range. When using the oven to cook one food, try to cook the rest of the meal in it also.
- Do not preheat when broiling, roasting or cooking items such as casseroles.

## The oven vent

Hot air and moisture escape from the oven through a vent located under the backguard. The vent is needed for air circulation. **Do not block the vent.** Poor baking/roasting will result.

**NOTE:** Never store plastics, paper or other items that could melt or burn near the oven vent, or any of the surface burners.

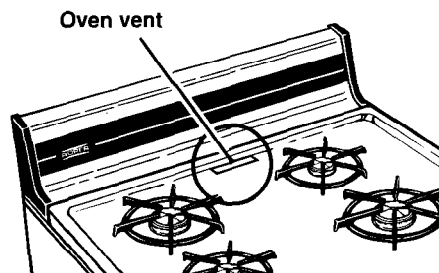

### **⚠ WARNING**

#### **Burn Hazard**

When the oven is ON, pans and pan handles left near the oven vent can become hot enough to burn the user and to melt plastics. Use potholders to move pans.

## The anti-tip bracket

The range will not tip during normal use. However, tipping can occur if excessive force or weight is applied to the open door without the anti-tip bracket properly secured.

**To verify the anti-tip bracket is engaged:**

- Look to see if the anti-tip bracket is attached with screws to the wall behind the backguard.
- Make sure the cable tether on the back of the range is secured by the two hooks on the bracket.
- See Installation Instructions for further details.

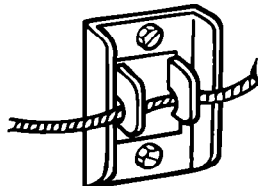

# Caring For Your Range

## In This Section

	Page		Page
Surface burner grates .....	16	Removing the oven door .....	18
Lift-up cooktop .....	17	Removing the oven bottom .....	19
Surface burners .....	17	Cleaning chart .....	20

Your range is designed for ease of care. Most cleaning can be done with items found around your home. Cleaning your range whenever spills or soiling occurs will help to keep it looking and operating like new.

## **⚠ WARNING**

### **Burn, Electrical Shock, Fire and Explosion Hazard**

- Make sure all controls are OFF and the range is cool before cleaning.
- Do not use oven cleaners, bleach or rust removers.
- Do not obstruct the flow of combustion and ventilation air.

Failure to follow these guidelines could result in burns, electrical shock, fire or explosion.

## Surface burner grates

1. Make sure all surface burners are off and the surrounding parts are cool.
2. Lift off the surface burner grates.
3. Wash the grates with warm, soapy water or in a dishwasher. Use a nonabrasive, plastic scrubbing pad for cooked-on foods. Rinse and dry well.
4. Replace burner grates.

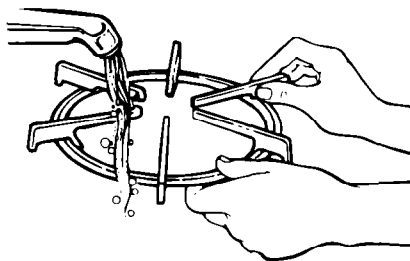



## Lift-up cooktop

1. Remove surface burner grates.
2. Lift front of cooktop at both front corners until the support rods lock into place.

### **⚠ WARNING**

#### **Personal Injury and Product Damage Hazard**

- Be sure both support rods are fully extended and in the locked position. Failure to do so could result in personal injury from the cooktop accidentally falling.
- Do not drop the cooktop. Damage can result to the porcelain and the cooktop frame.

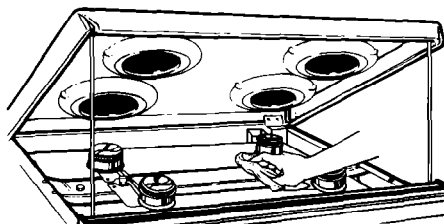

3. Wipe with warm, soapy water. Use a soapy steel-wool pad on heavily soiled areas.  
**NOTE:** When cleaning under the cooktop on standing pilot models, be careful not to extinguish pilots.
4. **To lower the cooktop**, lift cooktop from both sides while pressing the support rods back to unlock them. Lower the cooktop into place. Replace surface burner grates.

## Surface burners

1. Lift up the cooktop, following the instructions above.
2. Before cleaning, remove screws that hold each of the burners in place. The screws prevent the burners from moving during shipment. Remove the shipping screw with a Phillips head screwdriver, lift the burner up, tilt it to one side at the end closest to the ignitor and move it toward the back of the range. This separates the burner from the gas valve at the front of the range, so it can be easily removed.
3. Wipe off surface burners with warm, soapy water and a sponge after each use. To remove cooked-on food, soak the burners in a vinegar and water solution for 20-30 minutes. Scrub with a plastic scrubbing pad.
4. If ports are clogged, clean with a straight pin. **DO NOT enlarge or distort the ports. DO NOT use a toothpick to clean the ports.**

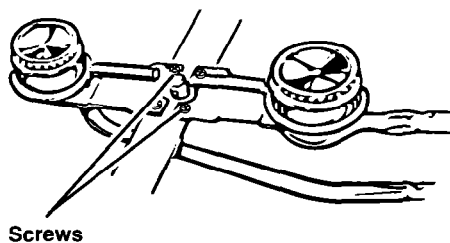

5. Before putting the burners back, dry them thoroughly by setting them in a warm oven for 30 minutes.
6. Replace burners, making sure they are properly seated and level. Replace screws.
7. Occasionally check the burner flames for proper size and shape as shown. A good flame is blue in color. If flames lift off ports, are yellow, or are noisy when turned off, you may need to clean the burners (see above), or call a qualified technician for adjustment.

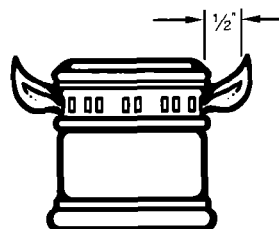

Typical surface burner flame  
at the highest setting

## Removing the oven door

Removing the oven door will help make it easier to clean the oven.

### ⚠ WARNING

#### Burn and Electrical Shock Hazard

Make sure all controls are OFF and the oven is cool before removing oven door. Failure to do so can result in burns or electrical shock.

### To remove:

1. Open the door as far as it will go.
2. Remove the screws on each side of the oven door.
3. Close the door about  $\frac{3}{4}$  of the way.
4. Lift the door up and off the hinges.

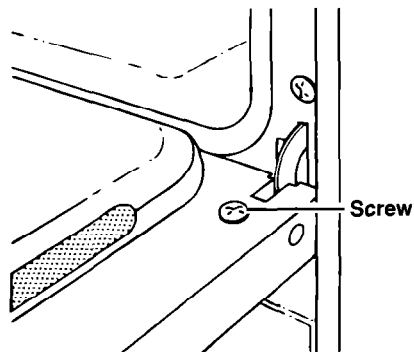

**To replace:**

1. Be sure the hinge arms are in the open position. Be careful if pulling the hinges open by hand. Hinges may snap back against the oven frame and could pinch fingers.
2. Hold the door at the sides near the top. Insert hinge arms into slots at the bottom of the door. Insert arms evenly, as far as they will go.
3. If the door is not in line with the oven frame, remove it and repeat the above steps.
4. Replace the screws on the oven door.

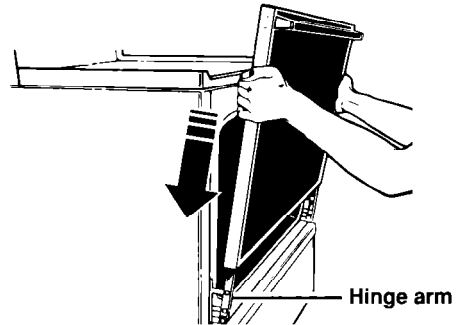

**Removing the oven bottom**

The panel in the oven bottom can be removed for cleaning.

**To remove:**

1. Remove oven racks.
2. Remove the two hold-down screws at the rear of the oven. If screws are too tight to remove by hand, use a screwdriver.

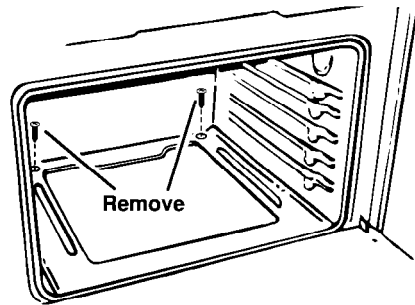

3. Place fingers in slots in bottom panel and lift rear of panel up and back until lip at the front of panel is clear of front frame of oven cavity.
4. Lift bottom up and out.

**To replace:**

1. Place oven bottom panel in oven with the back raised about 6 inches or until you can insert the hold-down lip at front of panel under the front frame of oven cavity.
2. Push back of oven bottom panel down fully into place on metal flanges on rear wall and insert the hold-down screws.

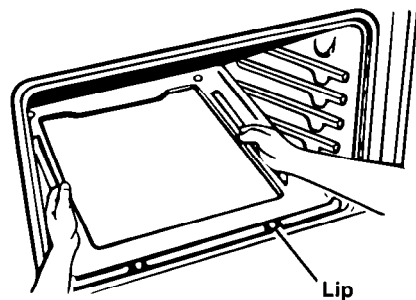

## Cleaning chart

Use the following table to help you clean all parts of your range.

PART	WHAT TO USE	HOW TO CLEAN
<b>Control knobs</b>	Sponge and warm, soapy water	<ul style="list-style-type: none"> <li>• Turn knobs to OFF and pull straight away from control panel.</li> <li>• Wash, rinse and dry thoroughly. Do not soak.</li> <li>• Replace knobs. Make sure all knobs point to OFF.</li> </ul> <p>DO NOT USE steel wool or abrasive cleaners. They may damage the finish of the knobs.</p>
<b>Control panel</b>	Sponge and warm, soapy water <b>OR</b> Paper towel and spray glass cleaner	<ul style="list-style-type: none"> <li>• Wash, rinse and dry thoroughly.</li> </ul> <p>DO NOT USE steel wool or abrasive cleaners. They may damage the finish.</p>
<b>Exterior surfaces</b> (other than control panel)	Sponge and warm, soapy water	<ul style="list-style-type: none"> <li>• Wash, rinse and dry thoroughly. USE nonabrasive, plastic scrubbing pad on heavily soiled areas.</li> <li>• Do not use abrasive or harsh cleansers.</li> </ul> <p><b>NOTE:</b> Do not allow foods containing acids (such as vinegar, tomato or lemon juice) to remain on surface. Acids may remove the glossy finish. Also wipe up milk or egg spills when cooktop is cool.</p>
<b>Surface burner grates</b>	Warm, soapy water and a nonabrasive, plastic scrubbing pad <b>OR</b> Dishwasher	<ul style="list-style-type: none"> <li>• In dishwasher, wash with other cooking utensils.</li> <li>• Dry completely.</li> <li>• <b>Do not use abrasive or harsh cleansers.</b></li> </ul>
<b>Surface burners</b>	Sponge and warm, soapy water  Warm, soapy water and a nonabrasive, plastic scrubbing pad <b>OR</b> Vinegar and water solution	<ul style="list-style-type: none"> <li>• Lift up the cooktop. (See page 17.)</li> <li>• Wipe off spills immediately after burner has cooled.</li> </ul> <p><b>For cooked-on food:</b></p> <ul style="list-style-type: none"> <li>• Remove burner from manifold with Phillips screwdriver.</li> <li>• Wash with warm, soapy water and a plastic scrubbing pad or soak in vinegar and water solution.</li> <li>• Rinse and dry well.</li> <li>• If ports are clogged, clean with a straight pin. <b>Do not enlarge or distort ports. Do not use a wooden toothpick.</b></li> <li>• Do not clean surface burner in dishwasher.</li> </ul>

PART	WHAT TO USE	HOW TO CLEAN
<b>Broiler drawer, pan and grid</b> (clean after each use)	Steel-wool pad and warm, soapy water	<ul style="list-style-type: none"> <li>• Clean after each use.</li> <li>• Wash, rinse and dry thoroughly.</li> <li>• <b>After broiler is cool</b>, wipe interior with warm, damp sponge. For heavily soiled areas, use a soapy steel-wool pad.</li> </ul>
<b>Oven racks</b>	Steel-wool pad and warm, soapy water	<ul style="list-style-type: none"> <li>• Wash, rinse and dry thoroughly.</li> </ul>
<b>Oven door glass</b> (Models FGP325Y, FGP320Y and FLP320Y)	Paper towel and spray glass cleaner <b>OR</b> Warm, soapy water and a nonabrasive, plastic scrubbing pad	<ul style="list-style-type: none"> <li>• Make sure oven is cool.</li> <li>• Follow directions provided with the cleaner.</li> <li>• Wash, rinse and dry thoroughly.</li> </ul>
<b>Oven cavity</b>	Sponge and warm, soapy water  Soapy steel-wool pad for heavily soiled areas <b>OR</b> Commercial oven cleaner for heavily soiled areas	<ul style="list-style-type: none"> <li>• Make sure oven is cool.</li> <li>• Remove door and oven bottom for easier access. (See pages 18 and 19.)</li> <li>• Wash, rinse and dry well.</li> <li>• Remove door for easier access.</li> <li>• Rinse well with water.</li> <li>• Remove door and oven bottom for easier access.</li> <li>• Place newspaper on floor to protect floor surface.</li> <li>• Follow directions provided with the oven cleaner.</li> <li>• Rinse well with clear water.</li> <li>• Use in well-ventilated room.</li> <li>• <b>Do not allow commercial oven cleaners to contact the heat seal, thermostat or exterior surfaces of the range. Damage will occur.</b></li> </ul>

# If You Need Assistance Or Service

This section is designed to help you save the cost of a service call. First we outline possible problems, their causes and their solutions. However, you may still need assistance or service. When calling our Consumer Assistance Center for help or calling for service, you will need to provide a complete description of the problem, your appliance's complete model and serial numbers and the purchase date. (See page 2.) This information is needed to respond to your request properly.

## 1. Before calling for assistance ...

Performance problems often result from little things you can find and fix without tools of any kind. Please check the chart below for problems you can fix. It could save you the cost of a service call.

<b>PROBLEM</b>	<b>POSSIBLE CAUSE</b>	<b>SOLUTION</b>
<b>Nothing will operate</b>	<p>The power cord is not plugged into a live circuit with proper voltage.</p> <p>Range is not properly connected to gas supply.</p> <p>A household fuse has blown or a circuit breaker has tripped.</p> <p>Controls are not set correctly.</p> <p>The flow of combustion and/or ventilation air to the range is blocked.</p>	<p>Plug the power cord into a live circuit with proper voltage. (See Installation Instructions.)</p> <p>Contact an authorized Roper service technician to reconnect range to gas supply. (See Installation Instructions.)</p> <p>Replace household fuse or reset circuit breaker.</p> <p>Reset controls, if needed.</p> <p>Remove blockage to airflow to and around range.</p>
<b>The oven will not operate</b>	<p>The Oven Temperature Control is not turned to a temperature setting.</p> <p>Pilot is extinguished on standing pilot models.</p>	<p>Push in and turn the Oven Temperature Control to a temperature setting.</p> <p>Light pilot. (See "Lighting standing pilots" on page 11.)</p>
<b>Burner fails to light</b>	<p>The power cord is not plugged into a live circuit with proper voltage.</p> <p>A household fuse has blown or a circuit breaker has tripped.</p> <p>Burner ports are clogged.</p> <p>Pilot is extinguished on standing pilot models.</p>	<p>Plug the power cord into a live circuit with proper voltage. (See Installation Instructions.)</p> <p>Replace household fuse or reset circuit breaker. In case of prolonged power failure, manually light burners (see page 8).</p> <p>Clean with a straight pin (see pages 17 and 20).</p> <p>Light pilot. (See "Lighting standing pilots" on page 11.)</p>
<b>Burner flames are uneven</b>	<p>Burner ports are clogged.</p>	<p>Clean with a straight pin (see pages 17 and 20). If this fails, call an authorized Roper service technician for service.</p>
<b>Burner flames lift off ports, are yellow, or are noisy when turned off</b>		<p>Contact an authorized Roper service technician to check air/gas mixture.</p>

<b>PROBLEM</b>	<b>POSSIBLE CAUSE</b>	<b>SOLUTION</b>
<b>Burner makes popping noise when on</b>	Burner is wet from washing.	Let dry.
<b>Control knob(s) will not turn</b>	You are not pushing in before turning.	Push control knob(s) in before turning to a setting.
<b>Cooking results are not what you expected</b>	<p>The range is not level.</p> <p>The oven temperature seems too low or too high.</p> <p>The oven was not preheated as the recipe calls for.</p> <p>The recipe has never been tested or is not from a reliable source.</p> <p>The pans are not the type or size recommended in the recipe.</p> <p>There is not proper air circulation around pan when baking.</p> <p>Flame size does not fit the cooking utensil being used.</p> <p>When broiling, you have not completely closed the broiler drawer.</p>	<p>Level range. (See Installation Instructions.)</p> <p>Adjust the oven temperature control. (See "Adjusting the oven temperature control" on page 13.)</p> <p>Preheat oven if called for in recipe.</p> <p>Use only tested recipes from a reliable source.</p> <p>Refer to a reliable cookbook for recommended pan type and size.</p> <p>Allow 1½ to 2 inches (4-5 cm) on all sides of the pans for air circulation.</p> <p>Adjust flame size to fit cooking utensil.</p> <p>Completely close broiler drawer.</p>

## **2. If you need assistance ...**

**Call our toll-free telephone number. Dial free from anywhere in the U.S.:**

**1-800-44-ROPER  
(1-800-447-6737)**

and talk with one of our trained consultants. The consultant can instruct you in how to obtain satisfactory operation from your appliance or, if service is necessary, recommend a qualified service company in your area.

For further information, write to:

Mr. William Clark  
Consumer Assistance Representative  
Roper Brand Appliances  
2000 M-63  
Benton Harbor, MI 49022

Please include a daytime phone number in your correspondence.

## **3. If you need service ...**

Contact the dealer from whom you purchased the appliance or the authorized servicer in your area. For help finding an authorized servicer in your area, call our toll-free telephone number in Step 2.

## **4. If you are not satisfied with how the problem was solved ...**

- Contact the Major Appliance Consumer Action Panel (MACAP). MACAP is a group of independent consumer experts that voices consumer views at the highest levels of the major appliance industry.
- Contact MACAP only when the dealer, authorized servicer and Roper Brand Appliance warrantor have failed to resolve your problem.  
Major Appliance Consumer Action Panel  
20 North Wacker Drive  
Chicago, IL 60606
- MACAP will in turn inform us of your action.

# ROPER<sup>®</sup> Gas Cooking Product Warranty

LENGTH OF WARRANTY	WHAT WE WILL PAY FOR
<b>FULL ONE-YEAR WARRANTY</b> (from date of purchase)	Replacement parts and repair labor to correct defects in materials or workmanship.  Service must be provided by an authorized Roper service company.
WHAT WE WILL NOT PAY FOR	
<p><b>A.</b> Service calls to:</p> <ol style="list-style-type: none"> <li>1. Correct the installation of your appliance.</li> <li>2. Instruct you how to use your appliance.</li> <li>3. Replace house fuses or correct house wiring or plumbing.</li> <li>4. Replace owner accessible light bulbs.</li> </ol> <p><b>B.</b> Repairs when appliance is used in other than normal, single-family household use.</p> <p><b>C.</b> Pickup and delivery. Your appliance is designed to be repaired in the home.</p> <p><b>D.</b> Damage to appliance caused by accident, misuse, fire, flood, acts of God, or use of products not approved by us.</p> <p><b>E.</b> Repairs to parts or systems caused by unauthorized modifications made to the appliance.</p>	

This Roper appliance is warranted by Whirlpool Corporation. Under no circumstances shall it be liable under this warranty for incidental or consequential damages and all implied warranties are limited to the same time period stated in the express warranties for Roper Brand Appliances. Some states do not allow the exclusion or limitation of incidental or consequential damages, so this limitation or exclusion may not apply to you.

This warranty gives you specific legal rights, and you may also have other rights which vary from state to state.

Outside the United States, a different warranty may apply. For details, please contact your authorized Roper distributor or military exchange.

If you need service, first see the "Assistance and Service" section of this book. After checking "Assistance and Service," additional help can be found by calling our toll-free telephone number, **1-800-44-ROPER (1-800-447-6737)**, from anywhere in the U.S.



## Free Manuals Download Website

<http://myh66.com>

<http://usermanuals.us>

<http://www.somanuals.com>

<http://www.4manuals.cc>

<http://www.manual-lib.com>

<http://www.404manual.com>

<http://www.luxmanual.com>

<http://aubethermostatmanual.com>

Golf course search by state

<http://golfingnear.com>

Email search by domain

<http://emailbydomain.com>

Auto manuals search

<http://auto.somanuals.com>

TV manuals search

<http://tv.somanuals.com>