

Warning!

THE DVA-3210 DVD/CD/MP3 PLAYER IS DESIGNED TO ENABLE VIEWING OF DVD OR CD-VIDEO RECORDINGS ONLY FOR REAR-SEAT OCCUPANTS.

MOBILE VIDEO PRODUCTS ARE NOT INTENDED FOR VIEWING BY THE DRIVER WHILE THE VEHICLE IS IN MOTION. SUCH USE MAY DISTRACT THE DRIVER OR INTERFERE WITH THE DRIVER'S SAFE OPERATION OF THE VEHICLE, AND THUS RESULT IN SERIOUS INJURY OR DEATH. SUCH USE MAY ALSO VIOLATE STATE LAW.

ROSEN ENTERTAINMENT SYSTEMS DISCLAIMS ANY LIABILITY FOR ANY BODILY INJURY OR PROPERTY DAMAGE THAT MAY RESULT FROM ANY IMPROPER OR UNINTENDED USE.

About Installation

Installation of mobile audio and video components requires experience with a variety of mechanical and electrical procedures. Even though this manual provides general installation and operation instructions for your new DVA-3210, it does not show the exact installation methods for your particular vehicle.

If you do not have the required knowledge and experience to successfully complete the installation, we strongly recommend consulting an authorized Rosen/necvox dealer about professional installation options.

Table of Contents

<i>Introduction</i>	2
<i>Care and Maintenance</i>	3
<i>Discs Played by the DVA-3210</i>	4
<i>Using the DVA-3210</i>	5
<i>The Remote Control</i>	6
<i>DVD/VCD/CD-Audio Playback</i>	7
<i>MP3 Playback on CD-R Discs</i>	10
<i>Installation and Wiring</i>	12
<i>Setup</i>	15
<i>Troubleshooting</i>	22
<i>Specifications</i>	22

INTRODUCTION

The DVA-3210 is a full-featured 10-disc changer, supporting DVD, CD-Video, CD-Audio, and MP3 playback, and is designed specifically for the mobile environment. It is intended for use with other Rosen/necvox products, and can also be integrated with many other products as part of a complete mobile video solution. With a digital audio output, the DVA-3210 can also support use of optional digital audio processors. The DVA-3210 incorporates many different video output settings to allow the best possible viewing experience, regardless of what type of video monitor you may be using.

The DVA-3210 plays DVD discs in PAL or NTSC formats (NTSC is the standard North American video format), CD-Audio discs, and CD-recordable discs with MP3 files. For more details on disc types supported, please see *"Discs Played by the DVA-3210."*

The DVA-3210 can connect directly to certain Rosen and necvox products (see your Rosen/necvox dealer for details). To connect to other products, the optional DVD Interface Kit is required. The optional remote control (included with compatible products or with the DVD Interface Kit) provides access to the full set of standard DVD functions, such as subtitle control, digital freeze-frame viewing, viewing from multiple camera angles, selection of various language audio soundtracks, and digital playback at fast or slow speeds.

Note:

- *The DVA-3210 is designed to be a component in a full audio/video system. If you have any questions about compatible components, such as monitors, in-dash products, or other audio/video products, please contact your authorized Rosen/necvox dealer.*

Accessories Supplied with the DVA-3210

- 13-pin data cable
- Assorted mounting hardware
- This Owner's Manual / Installation Guide

About the Registered Marks

This product incorporates copyright protection technology that is protected by method claims of certain U.S. patents and other intellectual property rights owned by Macrovision Corporation and other rights owners. Use of this copyright protection technology must be authorized by Macrovision Corporation, and is intended for home and other limited viewing uses only unless otherwise authorized by Macrovision Corporation. Reverse engineering or disassembly is prohibited.

Manufactured under license from Dolby Laboratories. Dolby and the double-D symbol are trademarks of Dolby Laboratories.

FCC Approval

This equipment has been tested and found to comply with the limits for a Class B digital device, pursuant to Part 15 of the FCC Rules. These limits are designed to provide reasonable protection against harmful interference in a residential installation. This equipment generates, uses, and can radiate radio frequency energy and, if not installed and used in accordance with the instructions, may cause harmful interference to radio communications. However, there is no guarantee that interference will not occur in a particular installation. If this equipment does cause harmful interference to radio or television reception, which can be determined by turning the equipment off and on, the user is encouraged to consult the dealer or an experienced radio/TV technician for help.

CARE AND MAINTENANCE

Handling Discs

Always handle a disc by its edges. Never touch the surface of the disc directly. To remove inadvertent fingerprints and dust, use a soft cloth and wipe in a straight line from the center of the disc to the outside edge. Never use liquid or aerosol cleaners, anti-static spray, or thinner to clean the disc surface. Do not place discs in the following places: direct sunlight; dirty, dusty and damp areas; near car heaters; on the seats or dashboard. Avoid using adhesive labels on discs.

Liquids and the DVA-3210

Keep all liquids, including beverages and cleaning liquids, away from the DVA-3210. Liquids inside the player can damage the electronics, and result in electrical shock or fire. If the unit or the remote control should become wet, turn off all power and contact an authorized Rosen/necvox dealer to have the system inspected.

Servicing the DVA-3210

This unit uses a precision mechanism. In the event that trouble arises, never open the case, disassemble the unit, or lubricate the rotating parts.

Do not attempt to open the unit or the remote control. The internal parts are not serviceable by the user. Opening any of the components will void the warranty. THE DVA-3210 IS A CLASS I LASER PRODUCT, USING A LASER WHICH COULD CAUSE HAZARDOUS RADIATION EXPOSURE IF IMPROPERLY DISASSEMBLED. All service should be performed by authorized Rosen service centers or other qualified service personnel.

CAUTION!

Changes or modifications to this product not approved by the manufacturer will void the warranty and will violate FCC approval.

Temperature and Moisture

If the player is used while the interior of the vehicle is very cold, condensation may form on the disc or on the internal optical pickup system and prevent proper playing of the disc. If you suspect that condensation is an issue, eject the disc and inspect the playing surface. If necessary, remove the condensation with a clean soft cloth as described above. If you still experience problems with playback, you will need to wait for approximately one hour to allow the DVA-3210 to warm up, and for the condensation to evaporate. If playback issues continue, please see your authorized Rosen/necvox dealer.

DISCS PLAYED BY THE DVA-3210

Discs Compatible with the DVA-3210

DVD, Video CD (VCD), CD/CD-R, and MP3 discs are compatible with the DVA-3210. The identifying logo and description of each disc type is given below.



DVD

12 cm disc/8 cm disc
(single-sided disc only)



Video CD

12 cm disc/8 cm disc



CD/CD-R, MP3

12 cm disc/8 cm disc

DVD Regions

This digital media player is designed and manufactured to respond to the Region Management Information that is recorded on a DVD disc. If the Region number described on

the DVD disc does not correspond to the Region number of this player (Region 1), this player will not be able to play the DVD disc. Some DVD discs are manufactured to operate in “all” zones, and those discs are compatible with the DVA-3210.

Region Icons:



Discs Incompatible with the DVA-3210

The following disc types are incompatible with the DVA-3210:

- DVD-ROM
- DVD-R/DVD-RW/DVD-RAM
- Photo CD
- CD-ROM (Excluding most CD-Recordable discs using MP3 or CD-A formats)
- CD-Audio manufactured with certain copy protection methods
- Any DVD with a Region number other than “1” and “ALL”

USING THE DVA-3210

In order to operate the DVA-3210, the vehicle ignition key switch must be in the ACC or engine ON position.



WARNING!

To prevent the battery from going dead, operate this unit with the engine running, if possible.

Please note that information about using the DVA-3210 will be displayed on the video screen connected to the unit, and initial setup of the DVA-3210 cannot be completed without an operating video monitor providing this on-screen display of menus and settings. Whenever the term “on-screen display” is used, it refers to the video monitor display.

THE OPTIONAL REMOTE CONTROL

(FOR A DVA-3210 COMPATIBLE UNIT)

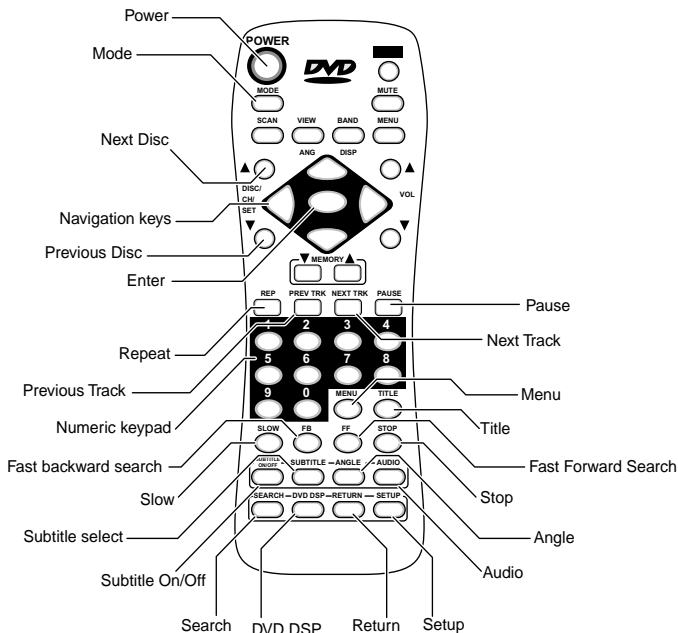

Using a Remote Control

The remote control described is included with the optional DVD Interface Kit (PN 9100-000-804). Similar remote controls using the same terminology are included with other Rosen/necvox products that are compatible with the DVA-3210.

Aim the remote control towards the external IR receiver (with in-dash products, the receiver is on the front panel). The remote control can operate at up to a 30-degree angle from the front of the unit.

If you try to perform an action that is not permitted at the moment, the DVA-3210 displays the following symbol on the connected video monitor:



This is typically displayed if a key is pressed during disc loading or ejecting, during the introduction section of a disc, or if you attempt to access certain sections of the Setup menu while the disc is in Play, Pause, or "pre-stop" mode. Also, this symbol will be displayed whenever the DVD disc inserted disallows the attempted action.

DVD/VCD/CD-AUDIO PLAYBACK

Inserting a DVD/VCD/CD

1 Insert discs label side down into the magazine as shown.

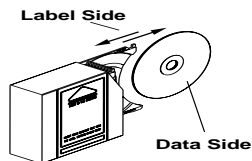

2 Open the sliding door.

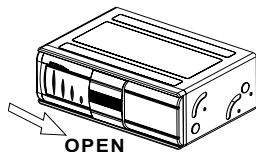

3 Insert the magazine as shown.

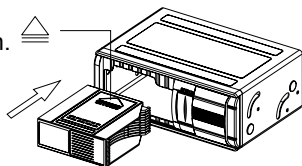

4 Close the sliding door.

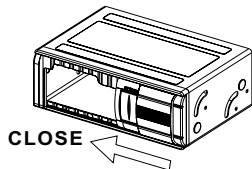

Disc Playback

DVD playback will often begin automatically when the magazine is inserted. With some DVD discs, you will need to press **[ENTER]** or **[▶||]** to begin playback.

CD-Audio discs will begin playback automatically.

CDs with MP3 files may require you to navigate the file structure menu. For more information, see "MP3 Playback on CD-R Discs."

Stopping Playback

There are two ways to stop playback:

- Pressing **[■]** **once** will stop playback, and the 410X will store the location last played on the disc. Playback can be resumed at the same point on the disc by pressing **[▶||]**.
- Pressing **[■]** **twice** will stop playback and clear the 410X's memory of the last point played on the disc. Pressing **[▶||]** at this point will cause the 410X to begin playback from the beginning of the disc.

Changing Discs

To change discs, use the **[Next Disc]/[Previous Disc]** buttons.

Selecting a Track or Chapter

Moving to the Next Track or Chapter

Press the **[NEXT]** button during playback. The next track or chapter will be selected.

Moving to the Previous Track or Chapter

Press the **[PREVIOUS]** button during playback. The first time this button is pressed, playback of the current track or chapter will restart from the beginning. Pressing this button again will cause the previous track or chapter to be played.

Fast Searching During Playback

Press **[>>]** and **[<<]** during playback to rapidly search for a particular section of a DVD or CD. Each time a fast-search button is pressed, the speed of the fast search changes as follows:

Standard Speed – 2X Standard Speed – 4X – 6X – 8X – Back to Standard Speed.

Pausing Playback

Press **[▶||]** during playback. Disc playback will pause, and the frame displayed at the point pause mode was entered will be displayed on the screen.

Press **[▶||]** again to return to normal playback.

Repeat Mode

Press the **[REPEAT]** button to select from the following repeat modes:

Repeat 1 - Repeat - Repeat Off.

With DVD playback, pressing the **[REPEAT]** button once causes the current chapter to be replayed. Pressing it twice enables the DVD disc to be continuously replayed.

With CD playback, pressing the **[REPEAT]** button once causes the current track to be replayed. Pressing it twice enables the disc to be continuously replayed.

Viewing Angles

The Angle Mark appears during scenes that offer multiple viewing angles. (Not all DVD discs support this function.) Use the **[ANGLE]** button to select from the various angles available. To conceal the Angle Mark, please see the “*Setup*” section.



Parental Control

The Parental Control feature allows authorized users to select an upper limit to film ratings that can be played by the DVA-3210. The factory default password for managing this feature is 3308. The password can be changed—see section 9, “Setup.”

If a DVD is inserted with a film rating higher than selected, one of the following screens will appear:

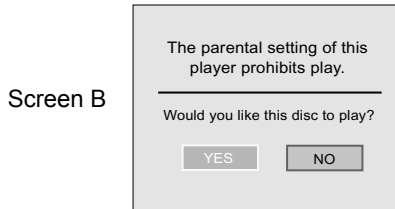

Screen A: In order for the film to play, the viewer must press Setup and change the Parental Control setting using the password. See the Setup section for more information.

Screen B: In order for the film to play, use the navigation and [ENTER] keys to select “Yes,” and then the four-digit numeric “password” must be entered. Use the numeric keypad on the remote to enter the password, and then press enter - the disc will begin playback.



Notes:

- To change the film rating setting, the password must be used.
- The DVA-3210 determines the correct film ratings to use based on the country selected in the “Locale” setting—see section 9 “Setup.”

MP3 PLAYBACK ON CD-R DISCS

What is MP3?

MP3 is an audio compression method. This audio compression method has become a standard format with many PC users. MP3 allows the original digital audio data to be compressed to about 10 percent of its initial file size while still retaining high sound quality. This means that about 10 music CDs can be recorded on a CD-R disc, thus allowing longer listening time without having to change CDs.

Notes:

- *The DVA-3210 cannot play discs recorded on a CD-RW unit.*
- *Some CDs recorded in CD-R mode may not be usable.*
- *Files without MP3 data will not play.*

MP3 Playback

When a disc with MP3 files is inserted, the SMART NAVI screen will appear. Each folder and file will be shown (the order may be slightly different than that on your PC). Navigate the files and folders using the navigation arrow keys, and select a file or folder to be played by using the **[ENT]** button.

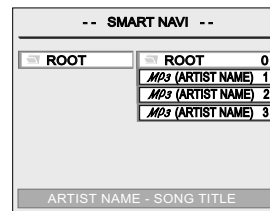

To move to the next file or the previous file, use the **[NEXT]** and **[PREVIOUS]** buttons.

To fast-forward or fast-reverse within a file, use the **[FR]** and **[FF]** buttons.

Three repeat modes are available for MP3 use:

- NO REPEAT
- REP – ONE repeats the current file
- FOLDER REP repeats the current folder

To conceal the SMART NAVI screen, see section “Setup.”

Supported MP3 File Formats

- ISO9660, level 1 and level 2 (the most common type of MP3 format)
- Joliet (a version of ISO9660 that supports longer filenames)

- Romeo (a format used by some CD-creating software)

File Extensions

Always add a file extension “.MP3” or “.mp3” to an MP3 file by using single-byte letters. If you add a different file extension, or forget to add the file extension “.MP3” or “.mp3,” the file cannot be played. In addition, if you use upper case and lower case letters (capital and small letters) mixed together for file extensions, normal play may not be possible.

Installation and Wiring

1. Before Starting

Read these instructions and the precautions carefully.

WARNING!

Be sure to disconnect the battery (-) terminal before starting. This is to prevent short circuits during installation.

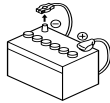

Precautions

- This unit is only for cars with negative ground 12V systems.
- Do not open the case. There are no user-serviceable parts inside. If you drop anything into the unit during installation, consult your dealer or an authorized Rosen service center.
- Use a soft, dry cloth to clean the case.

2. Package Contents

- 13-Pin Data Cable
- Installation Brackets and Assorted Hardware
- Owner's Manual / Installation Guide
- Warranty Card

3. Installation Requirements

- 1 Use the enclosed screws for installation. Using other screws can cause damage and void the warranty.
- 2 Before installation, **remove the three transport screws from the bottom of the unit!** Use a Phillips screwdriver.

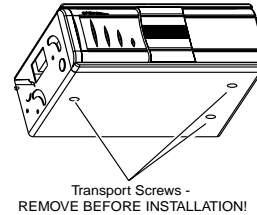

- 3 Install the unit in one of the three orientations shown. **Always adjust the springs as shown!**
Note: Never install the DVA-3210 on end!

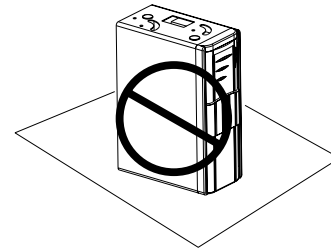

Spring adjustment - Always adjust the springs on both sides first!

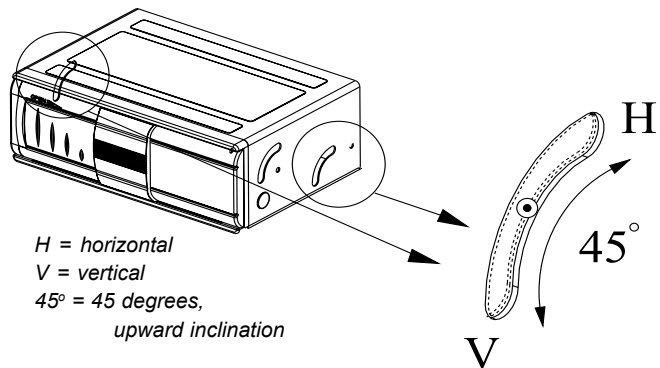

Horizontal, brackets up, or 45 degrees, upward inclination

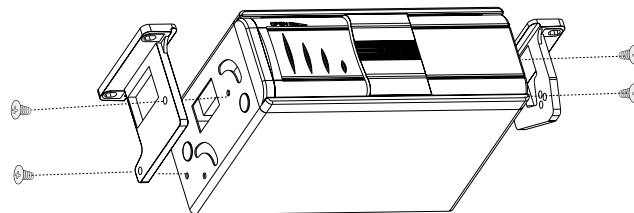

Vertical or 45 degrees, upward inclination

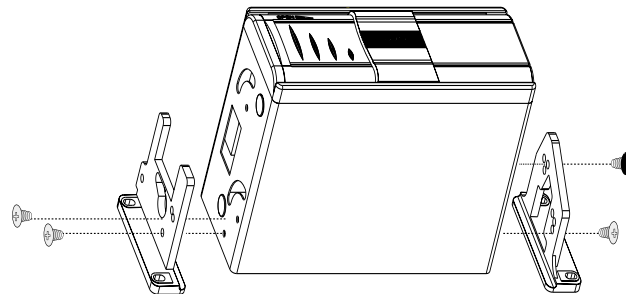

Horizontal, brackets down/ 45 degrees, upward inclination

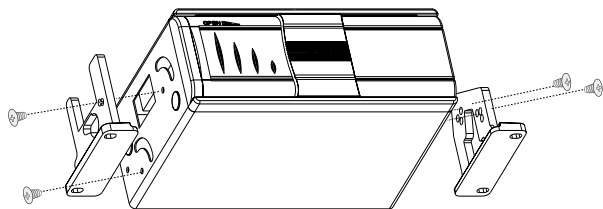

4. Installing the DVA-3210

Mount the unit in a dry location according to the illustrations on the previous page.

Ensure that the unit is firmly mounted and cannot come loose in the event of a collision.

Also ensure that there is sufficient clearance in front of the unit to reach the door readily, and for the magazine to fit into the loading slot.

CAUTION!

Do not overtighten the screws on uneven surfaces! This can cause damage to the unit. If an even mounting surface cannot be found, fabricate a flat panel, mount the unit to it, and mount that panel to the vehicle.

WARNING!

Always use great care when attaching anything to a vehicle! Visually inspect all sides of any potential screw location, to insure no damage will occur. If you have questions about this process, see your authorized necvox dealer.

5. Wiring the DVA-3210

Wiring the DVA-3210 varies with the installation. These instructions only cover connecting the cable -they do not cover the connections of the optional DVD interface kit.

With some Rosen and necvox units, the DVA-3210 can directly connect without the optional interface kit - see your Rosen/necvox dealer if you have questions about compatibility.

Read the following precautions before wiring any system.

- Disconnect the negative battery terminal before making any wiring connections.
- Be particularly careful where you route wires and cables. Keep them away from the engine, exhaust system, etc. Heat may damage wires.
- If a fuse should blow, make sure all connections are correct and no wires are damaged before replacing the fuse. Always use fuses that are the same amperage value as the original. When replacing a fuse, never let the battery side touch any metal part or any other wire.

DVA-3210 connecting to compatible control unit

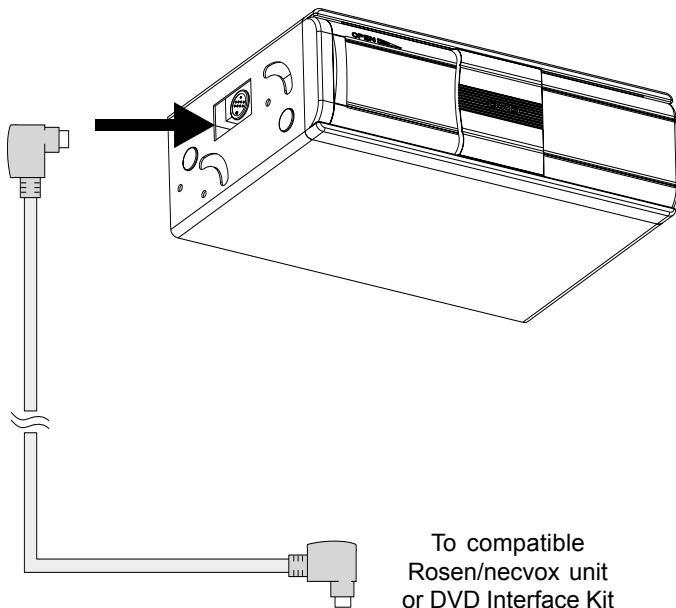

SETUP

DVA-3210 Typical Setup and Configuration

The DVA-3210 is very flexible. For more advanced setting options, please see the "Setup Options List" at the end of this section.

The DVA-3210 is shipped with the following configuration:

- Standard 4:3 aspect ratio format output
- Automatic NTSC/PAL output switching
- Analog stereo audio, digital audio output off
- All language options set to English
- Parental control off, and default password of 3308.

Note:

- *Since the DVA-3210 is capable of generating both NTSC or PAL video signals when set to "Multi" video output mode (see next page), upon first power-up the unit may generate the onscreen display in PAL mode. If this occurs with a system with NTSC video monitors, the picture will distort, "roll", and appear black-and-white. The easiest way to cause the DVA-3210 to automatically switch to NTSC mode is to insert an NTSC DVD disc. While the unit can be manually switched from "Multi" to "NTSC", it is difficult to do so if the display is not readable due to this distortion.*

Changing Settings

The following sections explain how to customize various features of the DVA-3210.

To change settings for your DVA-3210:

- 1 Press **[SETUP]**.
- 2 Use the **[▲]** and **[▼]** buttons to highlight a selection.
- 3 Press the **[ENT]** button to confirm your selection.

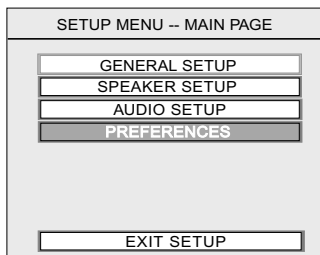

If you try to perform an action that is not permitted (such as accessing the Preferences menu while a disc is playing), the 410X displays the following symbol:



Changing the Aspect Ratio Mode

To change the aspect ratio mode, select GENERAL, and then select TV DISPLAY. For widescreen (16:9) monitors, select WIDE. For standard monitors and letterbox viewing (black bars on the top and bottom of the screen, but the entire image preserved), select NORMAL/LB. For standard 4:3 monitors and a full-screen image, but with the edges variably cropped to fit ("pan-and-scan" mode), select NORMAL/PS.

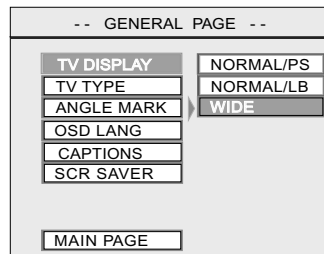
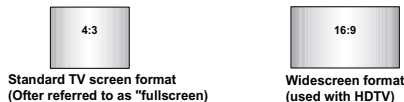

Changing the Video Output Mode

To change the video output mode, select GENERAL, and then select TV TYPE. The default is MULTI. If you experience problems playing a PAL disc on your NTSC monitors, select NTSC. If you are using European-spec PAL monitors exclusively, select PAL.

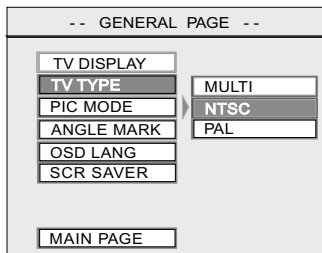

Note:

- The default "MULTI" will automatically output NTSC video from NTSC discs, and PAL video from PAL discs. Many video monitors can automatically handle either type of video signal. NTSC is the North American standard, and the only type of disc many North American users will encounter.

Concealing the "Angle Mark"

To display or conceal the "angle mark," which appears during scenes that support the multiple-viewing-angle feature, select GENERAL and ANGLE MARK.

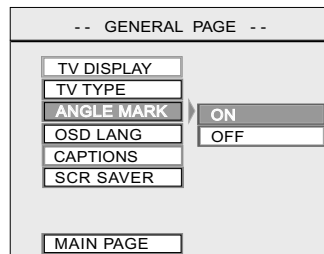

Activating Captions and Subtitles

To enable or disable captions or subtitles, select GENERAL and CAPTIONS.

Note:

- If CAPTIONS is set to OFF, the [SUBTITLE] button will be defeated from working. If SUBTITLE OFF is selected under Preferences – Audio, then the [SUBTITLE] button can still enable subtitles during playback, as long as CAPTIONS is set to ON.

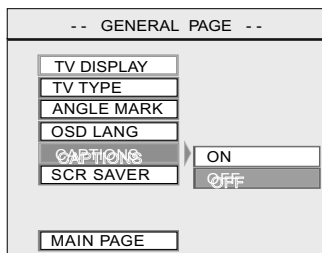

Activating the Digital Output

To turn on the digital output, select AUDIO and AUDIO OUT.

Note:

- Only enable the digital output when a digital audio processor is in use, since enabling it disables the analog audio output on the red and white RCA jacks. Also, some digital audio processors will require you to select an LPCM output frequency.

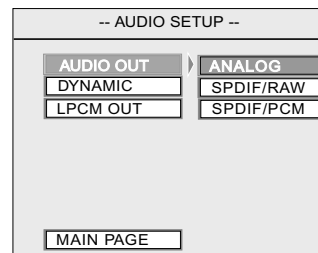

Selecting an LPCM Output Frequency

To select an LPCM output frequency (when a digital audio processor is in use), select AUDIO and LPCM OUTPUT.

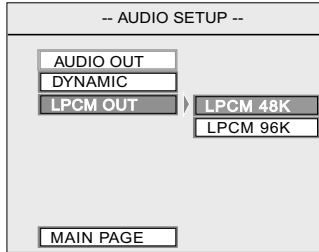

Deactivating the "Smart Nav" On-Screen Menu Display

To play MP3 discs without the "Smart Nav" on-screen menu display, select PREFERENCES, then SMART NAV.

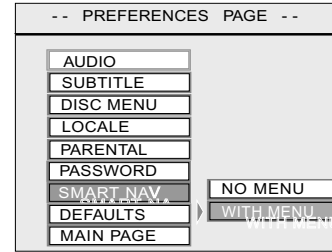

Changing Language Settings

Several language settings can be customized on the 410X.

Notes:

- Not all language settings are supported by all discs.
- The languages supported vary by individual option setting.

To change the on-screen display language, select GENERAL and OSD LANG.

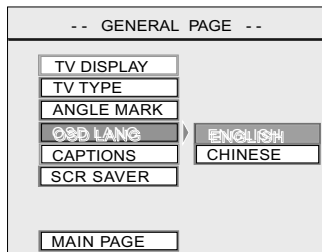

To change the soundtrack language, select PREFERENCES and AUDIO.

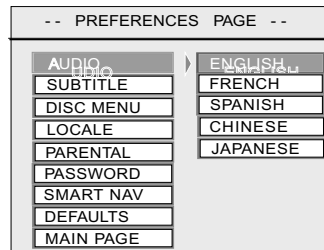

To change the subtitle or caption language, select PREFERENCES and SUBTITLE.

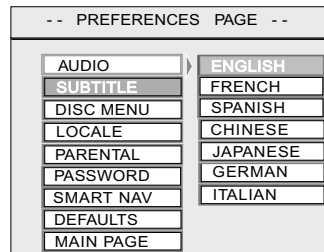

To change the disc menu language, select PREFERENCES and DISC MENU.

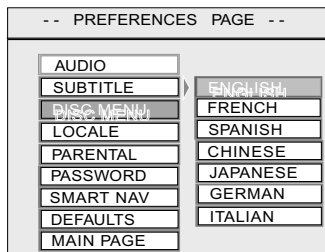

TROUBLESHOOTING

“Tinny” sound.

Check the “Downmix” setting in the SETUP menus and ensure that it is set to “Stereo,” not “LT/RT.”

No sound

Make sure that the audio output is set to “Analog”, under Audio, Audio Out.

Picture distorts, “rolls”, appears black and white.

Check that the TV Type setting is correct for the monitors being used. (See “*Changing the Video Output Mode*”.) PAL video often “rolls” on NTSC monitors.

With a widescreen 16:9 monitor, I have black bars on the top and bottom of my screen.

Change the TV Display mode to “Wide” in the Setup Menu.

The DVA-3210 does not track discs well.

Make sure the side spring adjustments are correct.

SPECIFICATIONS

Dimension (WxDxH) : W 262 mmX D 175 mmX H 82 mm

Weight : 2.5kg

Supply voltage: 12V DC Nominal, 11-16V operating voltage*

Temperature: 0° to 50° Celsius*

Current consumption: Less than 3.0A

Video:

Television System: NTSC/PAL

Aspect ratio: 4:3, 16:9

TV encoder resolution: 10-bit DA converter

Video Signal-to-noise ratio: 65dB

Discs played:

DVD video discs—

5" and 3" (12 & 8 cm) single-sided, single and double-layer

Compact discs (CD-DA, VIDEO-CD, CD-R)—

5" and 3" (12 & 8 cm) disc

Audio output level: 700mV RMS

Audio signal output characteristics:

Frequency response: 20 Hz - 20 kHz (CD audio/44.1kHz sampling rate)

S/N ratio: 90 dB (JIS)

Crosstalk: -75dB

Dynamic range: Above 85dB

Distortion: 0.02% (1 kHz)

Digital audio output: SPDIF optical output (IEC 958)

** Note: Use of the DVA-3210 beyond the safe operating ranges listed can cause temporary or permanent damage to the unit, and such damage may not covered by the manufacturer's warranty.*

DVA-3210 10-DISC CHANGER OWNER'S MANUAL ADDENDUM

This information describes an updated feature not described in the DVA-3210 Owner's Manual.

MP3 Playback on CD-R Discs

What is MP3?

MP3 is an audio compression method. This audio compression method has become a standard format with many PC users. MP3 allows the original digital audio data to be compressed to about 10 percent of its initial file size while still retaining high sound quality. This means that about 10 music CDs can be recorded on a CD-R disc, thus allowing longer listening time without having to change CDs.

Notes:

- The DVA-3210 cannot play discs recorded on a CD-RW unit.
- Some CDs recorded in CD-R mode may not be usable.
- Files without MP3 data will not play.

MP3 Playback

When a disc with MP3 files is inserted, the SMART NAVI screen will appear. Each folder and file will be shown (the order may be slightly different than that on your PC). Navigate the files and folders using the navigation arrow keys, and select a file or folder to be played by using the **[ENT]** button.

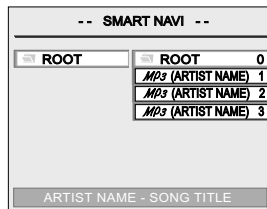

To move to the next file or the previous file, use the **[NEXT]** and **[PREVIOUS]** buttons.

To fast-forward or fast-reverse within a file, use the **[FR]** and **[FF]** buttons.

Three repeat modes are available for MP3 use:

- NO REPEAT
- REP – ONE repeats the current file
- FOLDER REP repeats the current folder

To conceal the SMART NAVI screen, Press "Setup" and select "Preferences".

Supported MP3 File Formats

- ISO9660, level 1 and level 2 (the most common type of MP3 format)
- Joliet (a version of ISO9660 that supports longer filenames)
- Romeo (a format used by some CD-creating software)

File Extensions

Always add a file extension ".MP3" or ".mp3" to an MP3 file by using single-byte letters. If you add a different file extension, or forget to add the file extension ".MP3" or ".mp3," the file cannot be played. In addition, if you use upper case and lower case letters (capital and small letters) mixed together for file extensions, normal play may not be possible.

Free Manuals Download Website

<http://myh66.com>

<http://usermanuals.us>

<http://www.somanuals.com>

<http://www.4manuals.cc>

<http://www.manual-lib.com>

<http://www.404manual.com>

<http://www.luxmanual.com>

<http://aubethermostatmanual.com>

Golf course search by state

<http://golfingnear.com>

Email search by domain

<http://emailbydomain.com>

Auto manuals search

<http://auto.somanuals.com>

TV manuals search

<http://tv.somanuals.com>