



Removable Tray Series [RX82-U (JBOD)]



3.5" SATA to USB Dual Bay Removable External Enclosure

User Manual

JBOD [JBOD stands for "Just a Bunch of Drives"]

- Single Drive Control
- The controller treats each drive as a stand-alone disk, therefore each drive is an independent logical drive.
- JBOD does not provide data redundancy.

Specifications

- Host Interface : USB 2.0 (480 mb/sec)
- Support Mode : JBOD
- Hard Drive Capacity : Support up to 1TB X 2
- Chipset : JM20336 Chip
- Drive Interface : 2 x 3.5" SATA I (1.5GHz) / SATA II (3.0GHz)
- Support Hot-Swap : 2 Hot-Swap drive trays
- Material : Aluminum Case
- LED status : Power - Blue Light ; Failed - Purple Light
- Cooling Fan : 4cm Ball Bearing Fan
- Power Supply : 100-240V, 70 Watts
- Dimension : 122W x 205D x 105H(mm)
- Weight : 1.67 kg

Features

- Two hard drives which can support vary brands of SATA I (1.5GHz) or SATA II (3.0GHz) and users could choose hard drives of their favor or use the original one.
- By installing two 1 TB hard drives could get 2 TB capacity.
- Hot-swappable tray module gives the user with convenience of replace hard disk and is not necessary to buy many of unrequisited of external devices.
- Build in with 70 Watts universal power supply which providing sufficient power resources to avoid the burden that brings by the adapter externally.
- The tray module is a optional purchase that enables several hard drives use RX82-U (JBOD) simultaneously.
- Through USB 2.0 main interface, RX82-U (JBOD) is movable and easy to be connected to all kinds of hosts.
- Compatible with Windows server 2000/2003, Windows 2000(SP4)/ME(SP2), Windows XP/Vista, Linux and Mac system.
- Additional Tray available (RX81-STRAY)

Package content

RX82-U (JBOD)	1	
RX81-STRAY	2	
USB cable	1	
Power cord	1	
Accessories bag	1	

(including 6 x 6#-32 screws and 2 x M3 X 6 screws, Key x 2)

Instruction Guide

Step.1

Press the key in the lock hole.

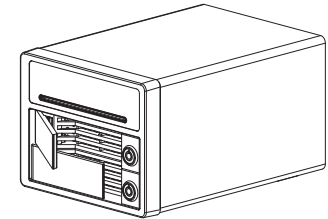

Step.2

Demount the transport holder.

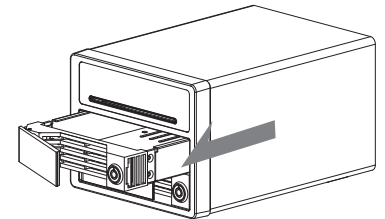

Step.3

Mount the HDD into the tray.

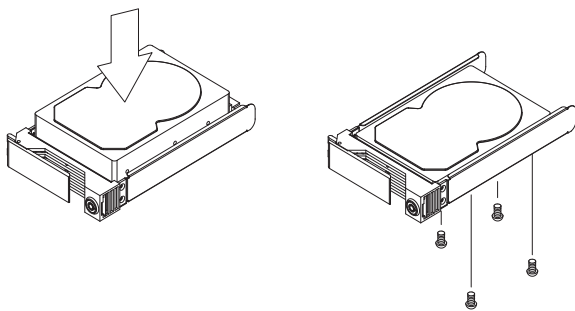

Step.4

Push the tray with the HDD back to the case.

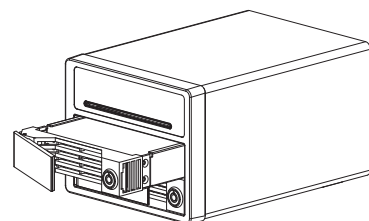

RX82-U (JBOD)

Attention

- A new HDD must first be initialised, partitioned and formatted by the operation system to be displayed by the system.
- Under JBOD mode which is two hard disks are connected to the computer through USB port and appear two independent hard disks on the computer.

Optional obtainable

1. Tray Module

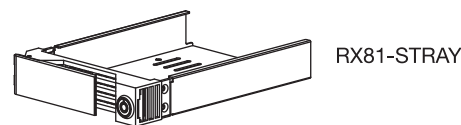

RX81-STRAY

Rosewill also has the optional tray (RX81-STRAY). If you have several hard drives, you could install them all in different RX81-STRAY trays and change the hard drive directly.

As reading information from different hard drives. It is convenient and efficient.(RX81-STRAY is design for hot-swap function)

User can also use interrelated products (such as RX81-US external box) at the same time. What you have to do is swap and change the tray instead of taking away the unit. (See picture below)

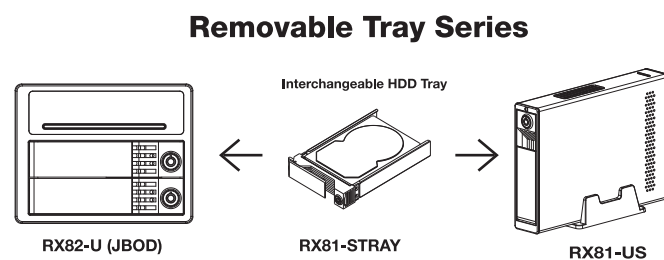

Hardware Installation

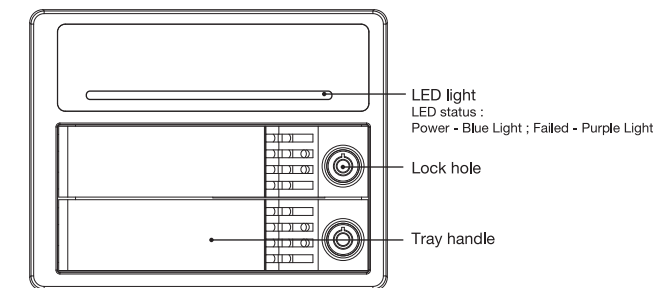

LED light
LED status :
Power - Blue Light ; Failed - Purple Light

Lock hole

Tray handle

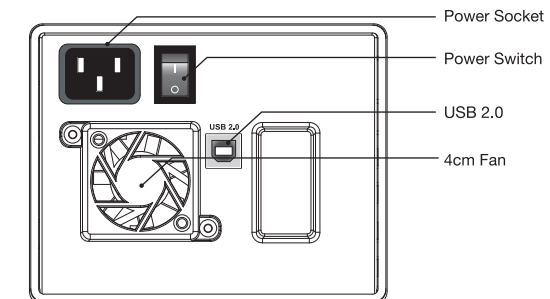

Power Socket

Power Switch

USB 2.0

4cm Fan



Thank you for purchasing a High-Quality Rosewill Product.

Please register your product at : www.rosewill.com
for complete warranty information and future support for your product.
If you have any question while using our products, please visit our website : www.rosewill.com
for latest driver & user manual or feel free to contact us at feedback@rosewill.com

Support Email: techsupport@rosewill.com

Free Manuals Download Website

<http://myh66.com>

<http://usermanuals.us>

<http://www.somanuals.com>

<http://www.4manuals.cc>

<http://www.manual-lib.com>

<http://www.404manual.com>

<http://www.luxmanual.com>

<http://aubethermostatmanual.com>

Golf course search by state

<http://golfingnear.com>

Email search by domain

<http://emailbydomain.com>

Auto manuals search

<http://auto.somanuals.com>

TV manuals search

<http://tv.somanuals.com>